



# Use and Care & Cooking Guide

## Spacemaker II™ Microwave Oven



<b>Safety</b> instructions .....	3-5
Precautions to Avoid Possible Exposure to Excessive Microwave Energy .....	2



Operating Instructions, Tips	
Add 30 Seconds .....	12
Aluminum Foil .....	4, 17, 27
Auto Cook .....	2 1-25
Auto Cook Control Guide .....	24, 25
Auto Defrost .....	16, 17
Auto Reheat .....	20, 21, 23
Auto Roast .....	18, 19
Auto Simmer .....	19
Auto Start/Reminder .....	12
Clock .....	8
Containers and Covers .....	23
Control Panel .....	8, 9
Cooking by Time .....	11, 12
Cooking Complete Reminder .....	7
Cooking Guide .....	30
Cookware .....	6, 23-25
Defrosting by Time .....	14
Defrosting Guide .....	29
Delayed Cooking .....	10
<b>Double Duty™ Shelf</b>	
.....	4, 5, 7, 13, 20, 21, 24, 26, 27, 31
Express Cook Feature .....	12
Features .....	7
Glossary of Microwave Terms .....	27
Heating or Reheating Guide .....	28
Hold Time .....	10
Microwaving Tips .....	6
Minute Pad .....	10
Minute/Second Timer .....	10
Popcorn .....	13
<b>Power Levels</b> .....	8-11, 14-16, 18, 28-30
Program Cooking .....	9
Temperature Cooking .....	15
<b>Temperature Probe</b>	
.....	4, 7, 8, 10, 15, 18, 19, 31, 34



Problem <b>Solver</b> .....	34
More questions ?...call	
GE Answer Center™ 800.626.2000	



<b>Care and Cleaning</b> .....	31, 32
Control Panel .....	31
Double Duty™ Shelf .....	31
Oven Lamp Replacement .....	32



<b>Installation</b> .....	32, 33
Adapter Plugs .....	33
Extension Cords .....	33
Grounding Instructions .....	32, 33



Consumer Services .....	35
Appliance Registration .....	2
Important Phone Numbers .....	35
Model and Serial Number Location .....	2
Warranty .....	Back Cover

Model: JEM31M

Microwave power output of this oven is 800 watts.

(IEC-705 Test Procedure)



## HELP US HELP YOU...

Before using your oven, read this book carefully.

It is intended to help you operate and maintain your new microwave oven properly.

Keep it handy for answers to your questions.

If you don't understand something or need more help, write (include your phone number):

Consumer Affairs  
GE Appliances  
Appliance Park  
Louisville, KY 40225

Write down the model and serial numbers.

You'll find them on a label inside the oven.

These numbers are also on the Consumer Product Ownership Registration Card that came with your microwave oven. Before sending in this card, please write these numbers here:

Model Number

Serial Number

Use these numbers in any correspondence or service calls concerning your microwave oven.

Be sure **your** microwave oven is registered.

It is important that we know the location of your microwave oven should a need occur for adjustments.

Your supplier is responsible for registering you as the owner.

Please check with your supplier to be sure he has done so; also send in your Consumer Product Ownership Registration Card. If you move, or if you are not the original purchaser, please write to us, stating model and serial numbers.

**This appliance must be registered. Please be certain that it is.**

Write to:

GE Appliances  
Range Product Service  
Appliance Park  
Louisville, KY 40225

If you received a damaged oven...

Immediately contact the dealer (or builder) that sold you the oven.

Save time and money. Before you request service...

Check the Problem Solver in the back of this book. It lists causes of minor operating problems that you can correct yourself.

All these things are normal with your microwave oven.

- Steam or vapor escaping from around the door.
- Light reflection around door or outer case.
- Dimming oven light and change in blower sound may occur while operating at power levels other than high.
- Dull thumping sound while oven is operating.
- Some TV-Radio interference might be noticed while using your microwave oven. It's similar to the interference caused by other small appliances and does not indicate a problem with your oven.

## PRECAUTIONS TO AVOID POSSIBLE EXPOSURE TO EXCESSIVE MICROWAVE ENERGY

- (a) Do Not Attempt to operate this oven with the door open since open-door operation can result in harmful exposure to microwave energy. It is important not to defeat or tamper with the safety interlocks.
- (b) Do Not Place any object between the oven front face and the door or allow soil or cleaner residue to accumulate on sealing surfaces.
- (c) **Do Not Operate** the oven if it is damaged. It is particularly important that the oven door close properly and that there is no damage to the:
  - (1) door (bent)
  - (2) hinges and latches (broken or loosened)
  - (3) door seals and sealing surfaces.
- (d) The Oven Should Not be adjusted or repaired by anyone except properly qualified service personnel.

# IMPORTANT SAFETY INSTRUCTIONS

Read all instructions before using this appliance.



When using electrical appliances, basic safety precautions should be followed, including the following:

**! WARNING**—To reduce the risk of burns, electric shock, fire, injury to persons or exposure to excessive microwave energy:

- Read and follow the specific “Precautions to Avoid Possible Exposure to Excessive Microwave Energy” on the previous page.
  - This appliance must be grounded, Connect only to properly grounded outlet. See Grounding Instructions section in the back of this book.
  - Use this appliance only for its intended use as described in this manual. Do not use corrosive chemicals or vapors in this appliance. This microwave oven is specifically designed to heat or cook food, and is not intended for laboratory or industrial use.
  - For best operation, plug this appliance into its own electrical outlet, to prevent flickering of **lights**, blowing of fuse or tripping of circuit breaker.
- 
- Do not mount this appliance over a **sink**. Install or locate this appliance **only** in accordance with the provided Installation Instructions.
  - Be certain to place the front surface of the door three inches or more back from the countertop edge to avoid **accidental** tipping of the appliance in normal **usage**.
  - Do not cover or block any openings on the appliance.
  - Do not store this appliance outdoors. Do not use this product near water—for example, in a wet basement, near a swimming pool or near a sink.
  - This microwave oven is not approved or tested for marine use.
  - Do not store anything directly on top of the microwave oven surface when the microwave oven is in operation.
  - Do not immerse power cord or plug in water.
- 
- Keep power cord away from heated surfaces.
  - Do not let power cord hang over edge of table or counter.
  - Do not operate this appliance if it has a damaged power cord or plug, if it is not working properly, or if it has been damaged or dropped.
  - See door surface cleaning instructions in the Care and Cleaning section(s) of this book.
  - This appliance should be serviced only by qualified service personnel. Contact nearest authorized service facility for examination, repair or adjustment.
  - As with any appliance, close supervision is necessary when used by children.
- 
- To reduce the risk of fire in the oven cavity:
    - Do not overcook food. Carefully attend appliance if paper, plastic or other combustible materials are placed inside the oven to facilitate cooking.
    - Remove wire twist-ties from paper or plastic bags before placing bags in oven.
    - Do not use your microwave oven to dry newspapers.
    - Do not use recycled paper **products**. Recycled paper towels, napkins and waxed paper can contain metal flecks which may cause arcing or ignite. Paper products containing nylon or nylon filaments should be avoided, as they may also ignite.
    - Do not pop popcorn in your microwave oven unless in a special microwave popcorn accessory or unless you use popcorn labeled for use in microwave ovens.
    - Do not operate the oven while empty to avoid damage to the oven and the danger of fire. If by accident the oven should run empty a minute or two, no harm is done. However, try to avoid operating the oven empty at all times—it saves energy and prolongs the life of the oven.
    - Do not overcook potatoes. They could dehydrate and catch fire, causing damage to your oven.

(continued next page)



# IMPORTANT SAFETY INSTRUCTIONS

(continued)

—Do not use the oven for storage purposes. Do not leave paper products, cooking utensils or food in the oven when not in use.

—If materials inside oven should ignite, keep oven door closed, turn oven off, and disconnect power cord, or shut off power at the fuse or circuit breaker panel.

- Some products such as whole eggs and sealed containers—for example, closed jars—will explode and should not be heated in this microwave oven. Such use of the microwave oven could result in injury.
- Avoid heating baby food in glass jars, even without their lids; especially meat and egg mixtures.
- Don't defrost frozen beverages in narrow necked bottles (especially carbonated beverages). Even if the container is opened, pressure can build up. This can cause the container to burst, possibly resulting in injury.
- Use **metal** only as directed in this book. TV dinners may be microwaved in foil trays less than 3/4" high; remove top foil cover and return tray to box. When using metal in the microwave oven, keep metal (other than metal **shelf**) at least 1 inch away from sides of oven.



• Cookware may become hot because of heat transferred from the heated food, Pot holders may be needed to handle the cookware.

- Sometimes the glass cooking tray can become too hot to touch. Be careful when touching the tray during and after cooking
- Foods cooked in liquids (such as pasta) may tend to boil over more rapidly than foods containing less moisture, Should this occur, refer to the Care and Cleaning section(s) for instructions on how to clean the inside of the oven.

- Thermometer—Do not use a thermometer in food you are microwaving unless the thermometer is designed or recommended for use in the microwave oven.
- Remove the temperature probe from the oven when not using it to cook with. If you leave the probe inside the oven without inserting it in the food or liquid, and turn on the microwave energy, it can create electrical arcing in the oven and damage oven walls.
- Plastic **cookware**—Plastic cookware designed for microwave cooking is very useful, but should be used carefully. Even microwave-safe plastic may not be as tolerant of overcooking conditions as are glass or ceramic materials and may soften or char if subjected to short periods of overcooking. In longer exposures to overcooking, the food and cookware could ignite. For these reasons: 1) Use microwave-safe plastics only and use them in strict compliance with the cookware manufacturer's recommendations. 2) Do not subject empty cookware to microwaving, 3) Do not permit children to use plastic cookware without complete supervision.

• When cooking pork, follow the directions exactly and always cook the meat to an internal temperature of at least 170°F. This assures that, in the remote possibility that trichina may be present in the meat, it will be killed and meat will be safe to eat,

- Do not boil eggs in a microwave oven. Pressure will build up inside egg yolk and will cause it to burst, possibly resulting in injury.



• Foods with unbroken outer "skin" such as potatoes, sausages, tomatoes, apples, chicken livers and other giblets, and egg yolks (see previous caution) should be pierced to allow steam to escape during cooking,



- **Not all** plastic wrap is suitable for **use** in microwave **ovens**. Check the package for proper use.



- **Spontaneous boiling**—Under certain special circumstances, liquids may start to boil during or shortly after removal from the microwave oven. To prevent burns from splashing liquid, stir the liquid briefly before removing the container from the microwave oven.

- **“Boilable” cooking pouches and tightly closed** plastic bags should be slit, pierced or vented as directed by package. If they are not, plastic could burst during or immediately after cooking, possibly resulting in injury. Also, plastic storage containers should be at least partially uncovered because they form a tight seal. When cooking with containers tightly covered with plastic wrap, remove covering carefully and direct steam away from hands and face.



- Hot foods **and** steam can cause burns. Be careful when opening any containers of hot food, including popcorn bags, cooking pouches and boxes. To prevent possible injury, direct steam away from hands and face.

- **Use** of the **DOUBLE DUTY™** shelf accessory.
  - Remove the shelf from oven when not in use.
  - Do not store or cook with shelf on floor of oven. Product damage may result.
  - Use pot holders when handling the shelf and cookware. They may be hot.
  - Do not use microwave browning dish on shelf. The shelf could overheat.
  - Use the shelf only when cooking on two levels.
  - Be sure that the shelf is positioned properly inside the oven to prevent product damage. Use of shelf with Auto Cook, Auto Reheat or Popcorn feature is not recommended (see the Auto Cook, Auto Reheat or Popcorn sections).

### Optional Accessories

Available at extra cost from your GE supplier.

**04-A019** Hanging Kit allows this oven to be mounted under a cabinet.

**JX37B** Installation Kit converts this oven to a built-in wall oven.

## SAVE THESE INSTRUCTIONS



## MICROWAVING TIPS

• **Make sure all cookware used in your microwave oven is suitable for microwaving.** Most glass casseroles, cooking dishes, measuring cups, custard cups, pottery or china dinnerware which does not have metallic trim or glaze with a metallic sheen can be used. Some cookware is labeled “suitable for microwaving.”

• **If you are not sure if a dish is microwave-safe, use this test:** Place in the oven both the dish you are testing and a glass measuring cup filled with one cup



water—set the measuring cup either in or next to the dish. Microwave 1 minute at high. If the dish heats, it should not be used for microwaving. If the dish remains cool and only the water in the cup heats, then the dish is microwave-safe.

- **Paper towels, waxed paper and plastic wrap** can be used to cover dishes in order to retain moisture and prevent spattering. Be sure to vent plastic wrap so steam can escape.
- **Some microwaved foods require stirring, rotating or rearranging.**
- **Steam builds up pressure in foods which are tightly covered by a skin or membrane.** Pierce potatoes, egg yolks and chicken livers to prevent bursting.

If you use a meat thermometer while cooking, make sure it is safe for use in microwave ovens.



## IF YOU NEED SERVICE...

To obtain service, see the Consumer Services page in the back of this book.

We're proud of our service and want you to be pleased. If for some reason you are not happy with the service you receive, here are three steps to follow for further help.

**FIRST**, contact the people who serviced your appliance. Explain why you are not pleased. In most cases, this will solve the-problem. “

**NEXT**, if you are still not pleased, write all the details—including your phone number—to:

Manager, Consumer Relations, GE Appliances  
Appliance Park, Louisville, KY 40225

**FINALLY**, if your problem is still not resolved, write:

Major Appliance Consumer Action Panel  
20 North Wacker Drive, Chicago, IL 60606

# FEATURES OF YOUR OVEN



## Cooking Complete Reminder (For all cooking features except Auto Roast code 4)

To remind you that you have food in the oven, the oven will beep once a minute until you either open the oven door or touch the CLEAR/OFF pad.

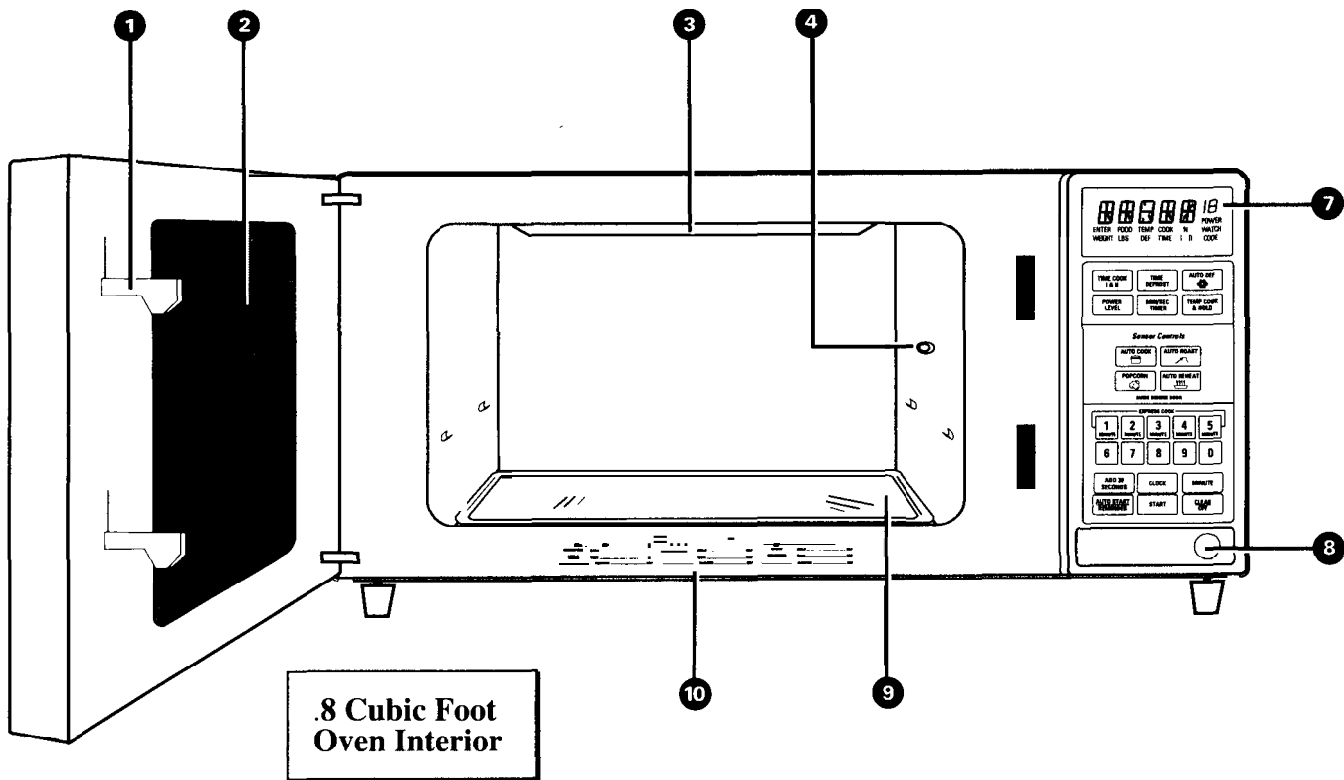
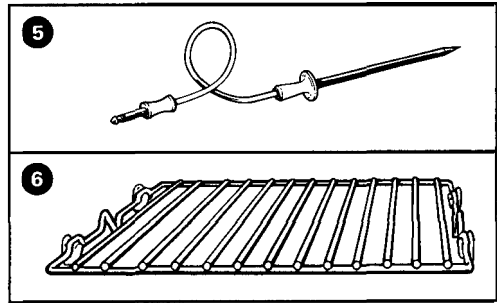

- 1. Door Latches.**
- 2. Door Screen.** Metal screen permits viewing of foods and keeps microwaves confined inside oven.
- 3. Mode Stirrer Cover.** Protects the microwave energy distributing system. Do not remove this cover. You will damage the oven.
- 4. Receptacle For Temperature Probe.** Temperature probe must be securely inserted into receptacle when using Temp Cook & Hold or Auto Roast.
- 5. Temperature Probe.** Use with Temp Cook& Hold and Auto Roast functions only.
- 6. DOUBLE DUTY™ Shelf.** Lets you microwave several foods at once. (See Safety Instructions and How to Use the Double Duty™ Shelf.) Food microwaves best when placed directly on the oven floor. Use this shelf only when cooking foods on two levels.
- 7. Touch Control Panel and Display.** See Your Touch Control Panel section for instructions.
- 8. Door Open Button.** Push to open door.
- 9. Glass Cooking Tray.** Tray must be in place when using the oven. Cooking performance will be unsatisfactory without the tray in place. The tray may be removed for cleaning.
- 10. Automatic Cooking Guide.** Quick reference codes for many frequently prepared foods.

**NOTE:** Rating plate, oven vents(s) and oven light are located on the inside walls of the microwave oven.



# YOUR TOUCH CONTROL PANEL

The Touch Control Panel allows you to set the oven controls with the touch of a finger. It's designed to be easy to use and understand.

## “Error” Appears on Display:

- During Auto Cook, Reheat or Popcorn program, the door was opened before steam could be detected.
- No steam was detected by sensor within four minutes and 10 seconds after start of Popcorn program.

## “PROBE” Appears on Display:

- Probe has been forgotten when Auto Roast or Temp Cook & Hold function is being used.
- Probe is not securely seated in oven wall receptacle.

1. **DISPLAY.** Displays time of day, time or temperature during cooking functions, power level being used, cooking mode and instructions.
2. **TIME DEFROST.** Gentle thawing at automatic power level 3 (Low).
3. **TIME COOK I & II.** Microwave for a selected amount of time using automatic power level 10 (High).
4. **POWER LEVEL.** Touch this pad after you enter the cooking time if you want to change from automatic power level 10 (High) for cooking or power level 3 (Low) for defrosting.
5. **MIN/SEC TIMER.** This feature uses no microwave energy. It functions as either a kitchen timer, as a holding period after defrost or as a delay timer before time or temperature cooking.
6. **AUTO COOK.** Touch this pad and then a number pad for desired code number, and oven automatically microwaves at pre-programmed power levels and determines the proper amount of cooking times until the food is done and oven shuts off.
7. **POPCORN.** Touch this pad and **START**, and the popcorn sensor determines the right cooking time. The microwave popcorn feature is designed to be used only with prepackaged microwave popcorn weighing 3.0 to 3.7 ounces.
8. **EXPRESS COOK.** Touch the number 1 through 5 pads for 1 to 5 minutes of cooking at power level 10. For example, touch 2 then **START** for 2 minutes at power level 10.
9. **CLOCK.** Touch this pad to enter time of day or check time of day while microwaving. To set clock, first touch **CLOCK** pad and then enter time of day. For example, if time is 1:30, touch number pads 1,3, and 0 and “1:30” will appear in display. Then touch **START** or **CLOCK** pad. To reset or change time, simply repeat this process.
10. **ADD 30 SECONDS.** Press this pad to add 30 seconds to the cook time as it's counting down.
11. **AUTO START/REMINDER.** Allows you to program your oven to begin cooking at a later time of day—up to a 12-hour delay. The Reminder feature can be used like an alarm clock.
12. **START.** After all selections are made, touch this pad to start the oven.
13. **AUTO DEFROST.** Touch this pad and enter food weight. The oven automatically sets power levels and defrosting time.
14. **TEMP COOK & HOLD.** Use the temperature probe to cook by using a preset temperature. Once food reaches preset temperature, oven switches to **HOLD** setting and maintains that temperature until you touch the **CLEAR/OFF** pad.
15. **AUTO ROAST.** Insert probe, touch this pad, and desired number pad for code to slow-cook or temperature cook meat with automatic preset program.
16. **AUTO REHEAT.** Use Auto Reheat for quick reheating of a variety of foods using different times and power levels.
17. **NUMBER PADS.** Touch these pads to enter cooking, defrosting time, time of day, temperature, power level, Auto Codes or food weights for Auto Defrost.
18. **MINUTE.** Use with number pads to enter whole minutes. For example, for 4 minutes touch 4 and **MINUTE**.
19. **CLEAR/OFF.** When touched, it shuts off the oven and erases all settings (except time of day).



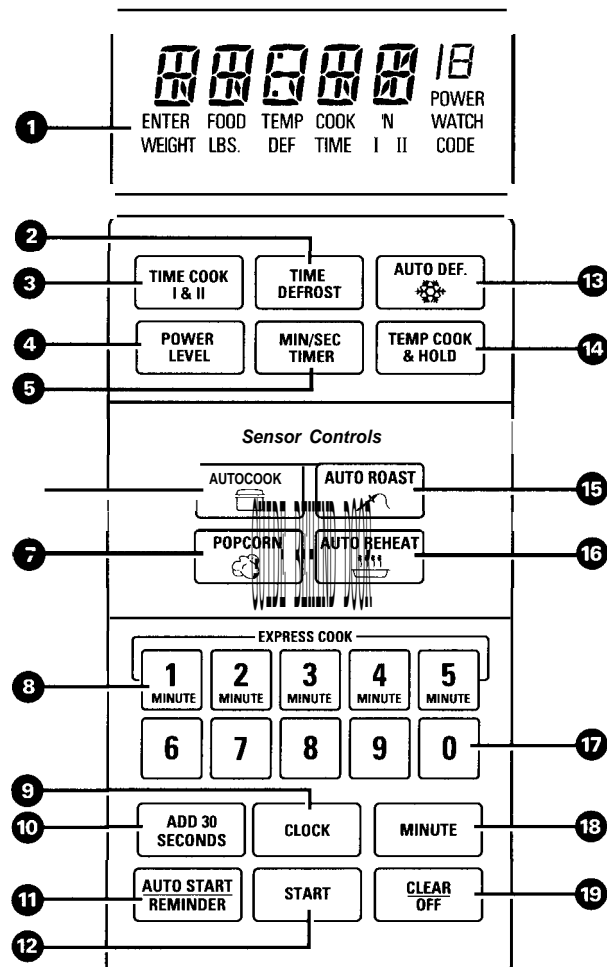

## Program Cooking

Use your Touch Control Panel to Auto Cook, Auto Roast, Auto Reheat and Auto Defrost—with the oven setting the power levels and cooking or heating times; to Temp Cook & Hold, using your choice of temperature; to Time Cook or Time Defrost, using your choice of power levels from 1 (lowest) to 10 (highest); to extend cooking time by 30 seconds using Add 30 Seconds pad; to set the clock; and to time kitchen tasks with the Minute/Second Timer.

Create your own programs to suit your individual cooking style. For example: program a hold time between Time Defrost and Time Cook I & II; set Time Cook I & II for a two-stage program using different times and power levels; or use the Minute/Second Timer to delay the start of a cooking function, such as Temp Cook & Hold.

## When You Plug in the Oven

The display panel lights up. After 15 seconds, all lights disappear and "RESET" appears. Touch the CLEAR/OFF pad and oven is ready for use and the clock can be set.

If power is disrupted at any time, the sequence at left recurs and you must reset clock after touching CLEAR/OFF.



# HOW TO USE THE MINUTE/SECOND TIMER

## The Minute/Second Timer

The Minute/Second Timer has three timing functions:

- It operates as a minute timer.
- It can be set to delay cooking.
- **It can be used as a hold setting after defrosting.**

The Minute/Second Timer operates without microwave energy.

## Using a Holding Time

The Minute/Second Timer can also be used to program a “holding time” between microwave cooking functions. The time can range from one second to 99 minutes and 99 seconds. A holding or standing time may be found in some of your own recipes or in a cookbook.

## How to Time a 3-Minute Phone Call

**Step 1:** Touch MIN/SEC TIMER pad.

**Step 2:** Touch 3 and MINUTE pad (for 3 minutes and no seconds).

**Step 3:** Touch START. Display shows time counting down. The timer signals when time is up.

## Programming Delayed Cooking

To delay cooking up to 99 minutes and 99 seconds, touch either TIME COOK I & II, TEMP COOK & HOLD or AUTO ROAST and enter cook time, temperature or code. Touch MIN/SEC TIMER and enter number of minutes to delay cooking. **When delaying Temp Cook & Hold or Auto Roast cooking, be sure probe is in food.** Touch START. Timer will count down to zero and cooking will begin.

## How to Defrost, Hold and Time Cook

Let’s say you want to defrost a frozen casserole for 15 minutes, hold for 10 minutes and then Time Cook for 25 minutes. Here’s how to do it:

**Step 1:** Take casserole from freezer and place in oven.

**Step 2:** Touch TIME DEFROST pad.

m \_\_\_\_\_



**Step 3:** Touch pads 1,5 and MINUTE pad for 15 minutes defrosting time. (Defrosting is automatically set on power level 3 but can be changed by touching the POWER LEVEL pad and the desired power level.)



**Step 4:** Set standing or hold time by touching MIN/SEC TIMER pad.

**Step 5:** Touch 1,0 and MINUTE pad to hold for ten minutes.



**Step 6:** Touch TIME COOK I & II pad.

**Step 7:** Touch 2,5 and MINUTE pad for 25 minutes of cooking time.



**Step 8:** Touch START. As each function is automatically performed, oven display shows instructions entered and the function. When time is up, the oven signals and flashes “End.”

# COOKING BY TIME



## Time Cook I

**Time Cook** allows you to microwave for a selected amount of time.

Power level 10 (High) is recommended for most cooking, but you may change this for more flexibility.

To become better acquainted with time cooking, make a cup of coffee by following the steps below.

**Step 1: Fill a cup**  
2/3-full of water, add 1 teaspoon of instant coffee and stir to dissolve. Use a cup that has no metal decoration and is microwave-safe (refer to Microwaving Tips section). Place cup in oven and close door.

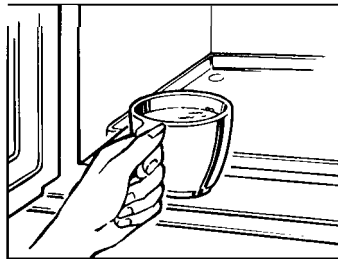

TIME COOK  
I & II

**Step 2:** Touch TIME COOK I & II pad.

MINUTE

**Step 3:** Select your time. Touch 1 and MINUTE pad for one minute.

Because automatic power level 10 is recommended for this cup of coffee, there is no need to change the power level. (If power level 10 is not appropriate, see "How to Change Power Level" below.)

START

**Step 4:** Touch the START pad.

**Step 5:** When time is up, the oven signals and flashes "End." The oven, light and fan shut off.

**Step 6:** Open the door.

If you interrupt Time Cook to check the food, simply close the door and press START to resume cooking. If there is not time remaining on the timer you must reset the timer to resume cooking.

### How to Change Power Level

1. Press TIME COOK I & II.
2. Select cooking time.
3. Press POWER LEVEL.
4. Select power.
5. Press START.

## Using the Time Cook II Feature

The Time Cook II feature lets you set two time cooking functions within one program. This is ideal if you want to change power levels during your cooking operations. Here's how to do it.

**Step 1:** Place food in oven in microwave-safe container and close the door.

TIME COOK  
I & II

**Step 2:** Touch TIME COOK I & II.

**Step 3:** Select your first cook time. For example, touch 2, 1 and 5 for two minutes and 15 seconds.

**Step 4:** Touch TIME COOK I & II.

**Step 5:** Set your second cook time.

**Step 6:** Change the power level.

### How to Change Power Level

1. Press TIME COOK I & II.
2. Select cooking time.
3. Press POWER LEVEL.
4. Select power.
5. Press START.

**Step 7:** "POWER 10," is displayed and "COOK TIME I" counts down.

**Step 8:** At the end of "COOK TIME I," the second power level is displayed and "COOK TIME II" is shown counting down.

**Step 9:** When time is up, the oven signals and flashes "End." The oven, light and fan shut off.

**Step 10:** Open the door.

If you interrupt Time Cook to check the food, simply close the door and press START to resume cooking. If there is not time remaining on the timer you must reset the timer to resume cooking.



# COOKING BY TIME

(continued)

## The Express Cook Feature

The Express Cook feature is a short-cut method to set time for 1-5 minutes.

To Express Cook your food or beverage:

**Step 1:** Touch a number pad (from 1 to 5) that corresponds with the amount of your desired cooking time (in minutes). For example, touch the 2 pad for 2 minutes of cooking time.

**Step 2:** Touch the START pad.

The oven will automatically signal, flash "End" and shut off at the end of the programmed time.

## Add 30 Seconds



The Add 30 Seconds feature provides a convenient way to extend cooking time by 30 seconds while the oven timer is counting down. It will add 30 seconds to the time shown each time the pad is touched.

## How to Use Auto Start

The Auto Start feature allows you to program your oven to begin cooking at a preset time of day—up to a 12-hour delay.

To Use Auto Start



**Step 1:** Touch AUTO START/REMINDER pad.

**Step 2:** Enter the time you want the oven to start. (Be sure your microwave oven clock shows the correct time of day.)

**Step 3:** Enter your desired cooking program.

**Step 4:** Touch START pad. The oven will automatically start at the desired time.

## How to Use Reminder

The Reminder feature can be used like an alarm clock, without starting the oven.

**Example:** It is 7 a.m. and you must remember to leave for a dentist appointment at 10 a.m.



**Step 1:** Touch AUTO START/REMINDER pad.

**Step 2:** Enter the time you want the oven to remind you. (Be sure your microwave oven clock shows the correct time of day. The reminder time can be set up to 12 hours later).

**Step 3:** Touch START pad. The reminder is now set at the time you programmed, and will signal you at that time with a beeping sound

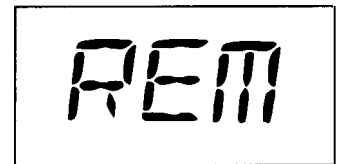

until you open the door or touch the CLEAR/OFF pad. The display will show REM until the oven door is opened or CLEAR/OFF is touched. The oven will signal continuously for up to 30 minutes. The REMinder time may be displayed by touching the AUTO START/REMINDER pad. The time-of-day may be displayed by touching the CLOCK pad.

# POPCORN

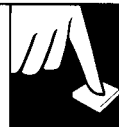

## NOTE:

Use of the metal Double Duty™ shelf with Popcorn program is NOT recommended.

The Popcorn feature is designed to be used only with prepackaged microwave popcorn weighing 3.0 to 3.7 ounces.

Step 1: Remove the outer wrapper from the microwave popcorn.

Step 2: Open oven door and place package of popcorn in the center of the oven floor as directed by the manufacturer's instructions. Close oven door.



Step 3: Touch POPCORN pad.

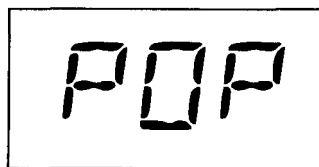

"POP" flashes. After 4 seconds, "START" flashes on display.



Step 4: Touch START. The popcorn sensor automatically calculates the cooking time.

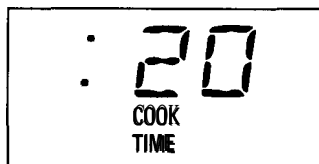

After the popcorn sensor detects steam, the oven signals and displays remaining cooking time needed.

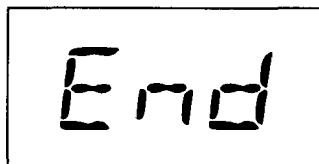

Step 5: When cooking is completed, the oven signals and flashes "End." Open the door and remove the popcorn.

## How to Adjust the POP Program to Provide a Shorter or Longer Cook Time

If your favorite popcorn is not completely popped, there is a simple adjustment you can make.

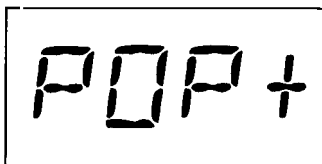

Touch the POPCORN pad and then touch number pad 9. The word "POP" will appear on the display with a plus sign beside it. The plus sign indicates 20 seconds more cooking time is being provided.

If your favorite popcorn is overcooked, there is another adjustment you can make.

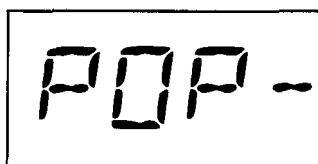

Touch the POPCORN pad and then touch number pad 1. The word "POP" will appear on the display with a minus sign beside it. The minus sign indicates 20 seconds less cooking time is being provided.

## Questions and Answers

**Q. I opened the door to check on the popcorn and "Error" appeared on the display. Why?**

**A.** The Popcorn program first detects steam and then switches to Time Cook. If you open the door while "POP" is displayed, "Error" will appear. Close the door, touch CLEAR/OFF and begin again. You may open the door when "End" appears on display.

**Q. Can I use regular popcorn with the Popcorn feature in my microwave oven?**

**A. No.** This automatic function is designed to be used only with prepackaged microwave popcorn.



## DEFROSTING BY TIME

### Time Defrost (Power Level 3)

Time Defrost is designed for speedy thawing of frozen food and is one of the great advantages of a microwave oven.

Use the Time Defrost setting to quickly thaw foods such as bread, rolls, vegetables, fruits and frozen dinners. The Auto Defrost setting is preferred for meat and poultry because the oven sets the defrosting time and power levels for you.

- Power level 3 is automatically set when you press TIME DEFROST pad, but you may change this for more flexibility.

#### How to Change Power Level

1. Press TIME DEFROST.
2. Select defrosting time.
3. Press POWER LEVEL.
4. Select power.
5. Press START.

To become better acquainted with the defrost function, defrost a 10 oz. package of frozen strawberries by following the steps below.

**Step 1:** Place package of frozen strawberries in the oven and close door. Be sure package contains no metal.



Step 2: Touch TIME DEFROST.

**Step 3:** Select one half of the total defrosting time recommended. For example, touch 4 and MINUTE pad for 4 minutes.



**Step 4:** Touch START. When the cycle is completed, the oven signals and flashes "End," then automatically shuts off.

**Step 5:** Turn the package over, close the door and repeat Steps 2 and 3 to set remaining half of defrosting time and touch START.

**Step 6:** When the oven signals and flashes "End," open the door, remove the package and separate strawberries to finish defrosting.

### Defrosting Tips

- Foods frozen in paper or plastic can be defrosted in the package.



- Family-size, pre-packaged frozen dinners can be defrosted and microwaved. If the food is in a foil container, transfer it to a microwave-safe dish.

- For even defrosting, some foods need to be broken up or separated part of the way through the defrosting time.

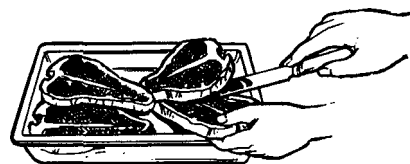

- Foods that spoil easily, such as milk, eggs, fish, stuffings, poultry and pork should not be allowed to sit out for more than one hour after defrosting. Room temperature promotes the growth of harmful bacteria.

### Questions and Answers

**Q. When I press START, I hear a dull, thumping noise. What is it?**

**A. This sound is normal.** It is letting you know the oven is using a power level lower than 10 (High).

**Q. Can I defrost small items in a hurry?**

**A. Yes,** but they will need more frequent attention than usual. Raise the power level after entering the time by touching the desired power level pad. Power level 7 cuts the total defrosting time in about 1/2; Power level 10 cuts the total defrosting time to approximately 1/3. During either, rotate or stir food frequently.

# COOKING BY TEMPERATURE



**Internal temperature is the best test of doneness** for many foods.

Use Temp Cook & Hold to cook a variety of foods to the desired finished food temperature. The Time Cook I & II setting is recommended for batters, doughs, frozen foods and foods which are difficult to cook precisely with the probe.

Temp Cook & Hold takes the guesswork out of cooking, because the oven automatically switches to "Hold" setting after reaching the preset food temperature and maintains that temperature for up to one hour or until you touch the CLEAR/OFF pad.

NOTE: Oven automatically switches to "Hold" when preset food temperature is reached.

## The Temperature Probe

The temperature probe is a food thermometer that gauges the internal temperature of your food. (Its appearance may vary from picture at right.) The probe must be used when using Temp Cook & Hold or Auto Roast. To use the probe properly, follow directions in the Automatic Roasting section.

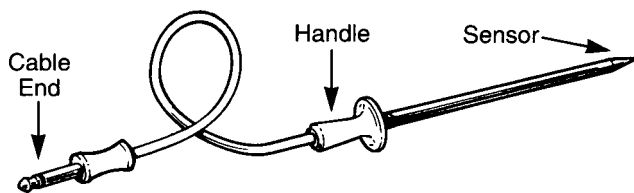

## How to Temp Cook a Rolled Beef Rib Roast to Medium

**Step 1:** Insert temperature probe and attach probe securely in oven wall. Close the door.

**TEMP COOK  
& HOLD**

**Step 2:** Touch TEMP COOK & HOLD pad.

**Step 3:** Touch 1,6 and O for 160°F.

**POWER  
LEVEL**

**Step 4:** Touch POWER LEVEL pad. Touch 5 for medium power.

**START**

**Step 5:** Touch the START pad. If internal temperature of the roast is less than 90°F., display will show "COOL"; if temperature is 90°F. or above, display shows temperature counting up.

**Step 6:** When 160°F. is reached, the oven will sound and display "Hold." The oven will then hold the temperature.

**CLEAR  
OFF**

**Step 7:** Touch the CLEAR/OFF pad to stop the cycle.

**Step 8:** Remove probe and food from the oven.

## Cooking Tips

- Use a lower power level; foods will heat more evenly though requiring more time.
- Be sure frozen food has been completely defrosted before inserting probe. Probe may break off if used in frozen foods.
- Cover foods loosely for moisture control and quick, even heating.

## Questions and Answers

**Q. Why did "PROBE" flash on the display after I touched the START pad?**

**A.** "PROBE" will flash if you don't seat the cable end of the probe securely into the receptacle in the oven wall or if you touch the TEMP COOK & HOLD pad and forget to use the probe.

**Q. Can I leave my probe in the oven if it's not inserted in food?**

**A.** No, if it touches the oven wall, it may damage the oven.



# AUTO DEFROST

## Auto Defrost

With the Auto Defrost feature, the oven automatically sets the **defrosting times and power levels** for you.

Use the Auto Defrost Guide on the next page. Enter the food weight in pounds and tenths of a pound (see Conversion Guide below). Then touch START pad.

The oven calculates defrosting time and changes power levels during defrosting to give even defrosting results.

## How to Set Auto Defrost

**Before you begin, check the guide located at front of oven when you open the door.** It shows minimum and maximum food weights for a variety of foods. You will need to know your food weight before setting Auto Defrost.

**Step 1:** Remove food from package, place in oven on microwave-safe dish and close door.



**Step 2:** Touch the AUTO DEF. pad.



**Step 3:** Enter weight. For example, touch number pads 1 and 2 for weight of 1.2 pounds (1 pound, 3 ounces. See Conversion Guide below.)



**Step 4:** Touch START pad. Display shows defrost time counting down.

**Twice during defrosting, the oven beeps 4 times and "TURn" flashes.**

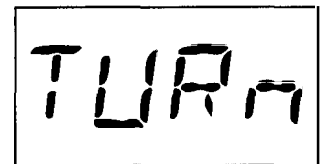

Follow the directions in the Auto Defrost Guide for what to do at the first and second signal. Then close the door and touch START. (Defrosting continues during "TURn" display.)

When defrosting time is completed, "End" flashes and oven beeps 4 times. "End" remains on display and oven beeps every minute until door is opened or CLEAR/OFF pad is touched.

## Stand Time

After Auto Defrosting, meat needs to stand in order to let the inside defrost. You may take the food out of the oven if you wish. Stand time recommendations are given in the guide on the next page.

## Conversion Guide

If the weight of food is stated in pounds and ounces, the ounces must be converted to tenths (.1) of a pound.

Ounces	Pounds
1-2	.1
3	.2
4-5	.3
6-7	.4
8	.5
9-10	.6
11	.7
12-13	.8
14-15	.9



# AUTO DEFROST GUIDE



RECOMMENDED FOODS	MIN.-MAX. WEIGHT	FIRST SIGNAL	SECOND SIGNAL	STAND TIME
<b>Meat</b>				
Chops	0.1 -6.0 lbs.	Turn over.	Separate and shield where necessary.	5 minutes
Frankfurters, Sausage	0.1 -6.0 lbs.	Separate.	Remove defrosted pieces.	2 minutes
Ground Meat	0.1 -6.0 lbs.	Turn over.	Remove defrosted areas and break apart.	5 minutes
Beef Patties	0.1 -6.0 lbs.	Turn over.	Separate patties.	5 minutes
Roast	0.1 -6.0 lbs.	Turn over and shield.	Shield if necessary.	90 minutes
Ribs	0.1 -6.0 lbs.	Turn over.	Remove defrosted pieces. Shield if necessary.	10 minutes
Steak	0.1 -6.0 lbs.	Turn over.		5 minutes
Stew	0.1 -6.0 lbs.	Turn over and separate.	Separate and remove defrosted pieces.	5 minutes
<b>Poultry</b>				
Whole Chicken	0.1 -6.0 lbs.	Turn over and shield.	Turn over and shield.	10 minutes; run cold water in cavity.
Turkey Breast (breast side up)	0.1 -6.0 lbs.	Turn over,	Shield where necessary.	20 minutes in refrigerator; run cold water in cavity.
Chicken Pieces	0.1 -6.0 lbs.	Turn over.	Separate and remove defrosted pieces.	5 minutes
Cornish Hens (whole)	0.1 -6.0 lbs.	Remove wrapper and turn over.		10 minutes; run cold water in cavity.
Cornish Hens (split)	0.1 - 6.0 lbs.	Turnover.		5 minutes
<b>Seafood</b>				
Fish Fillets	0.1 -6.0 lbs.	Turn over.	Separate and remove defrosted pieces.	5 minutes
Shrimp, Scallops	0.1 -6.0 lbs.	Separate.	Separate and remove defrosted pieces.	5 minutes
Whole Fish	0.1 - 6.0 lbs.	Turn over and shield tail and head.		Hold under cold running water.

Edges or thin areas of meat will defrost more rapidly than other areas. After first or second signal, shield warm areas with small pieces of foil.



# AUTOMATIC ROASTING

**Auto Roast uses the temperature probe to cook to the desired serving temperature. Unlike Temp Cook & Hold, which uses a single power level, Auto Roast uses up to 3 power settings which automatically switch during roasting, thus providing even, tender cooking results without overcooking.**

Just as in regular roasting, only tender roasts should be Auto Roasted until specified internal temperatures are reached. Less tender roasts should be microwaved by time.

## Preparing Roasts for Auto Roasting

Place tender beef roast in cooking bag on trivet in microwave-safe dish. (Refer to package instructions for proper use of cooking bag.) Insert probe through cooking bag horizontally into the center meaty area not touching bone or fat. Make sure the handle does not touch the food or top or sides of the oven.

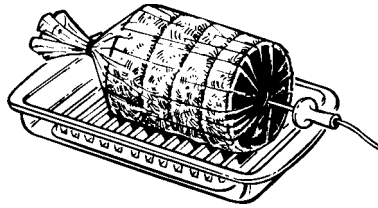

Place pork roast in cooking bag and place in microwave-safe dish.

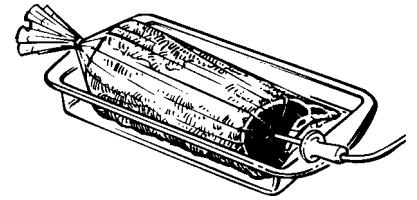

Place meat in oven with probe to the right. Insert cable end of probe firmly into receptacle on oven wall.

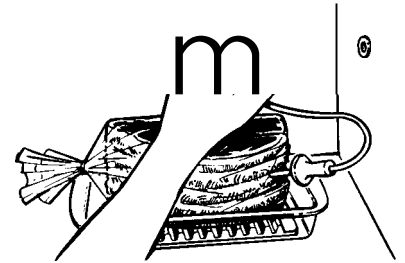

## How to Auto Roast Beef to Medium

**Step 1:** Touch AUTO ROAST pad. Touch number pad 1. Touch START. (See the "Auto Roast Guide" for complete list of recommended codes.)



**NOTE:** By touching the AUTO ROAST pad during cooking, the meat's internal temperature will be displayed. ("COOL" will be displayed until meat reaches 90°F.) When pad is released, doneness code reappears on the display.



**Step 2:** When you select Auto Roast codes 1 or 2, the oven signals with 4 beeps and "TURN" flashes on the display when it's time to turn

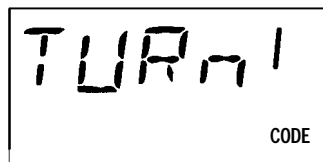

the roast over. After you turn the roast, close the door and touch START. (**NOTE:** Oven continues to cook after the signal whether or not roast is turned over.)

**Step 3:** After a pre-programmed food temperature is reached, oven beeps 4 times and "HOLD" appears on the display.

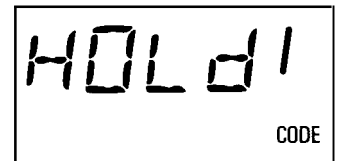

**Step 4:** Food will be held at this temperature for 60 minutes. The oven then beeps 4 times and "End" appears.

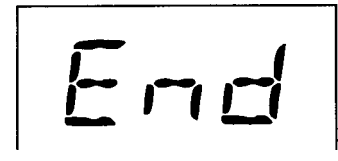



## Auto Roast Guide

- Place meats in a cooking bag in microwave-safe dish. (Refer to package instructions for proper use of cooking bag.)
- Recommended codes are shown on guide behind door, on front of oven.
- Insert probe as described elsewhere in this section.

Food	Code	Minimum Final Temp.	Approx. Time (minutes per pound)	Hold* Minutes	Doneness Display
Beef (5 lb. max.) Tender Roast					
	1	160°F.	13-15	0	MEd
	2	170°F.	15-17	5-10	WELL
Pork (5 lb. max.) Loin Roast	2	170°F.	15-19	10	WELL
Poultry (6 lb. max.) Turkey Breast (Insert probe horizontally into meatiest area.)	3	185°F.	17-20	10-15	WELL

\*Recommended standing time before serving.

## Automatic Simmer (Auto Roast Code 4)

Total time includes time to bring food to 180°F., and hold at that temperature until done.

Set Auto Simmer like **Auto Roast as explained** in this section. Display shows "SIM" and "CODE 4."

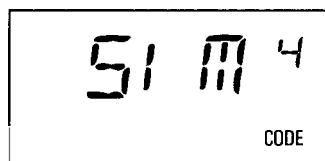

Oven switches to Hold at 180°F., and continues holding at 180°F. until you remove food and touch CLEAR/OFF pad. If stirring is recommended, you can restart oven by touching the START pad again. Touch CLEAR/OFF pad to turn off oven.

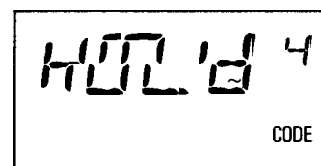

## Automatic Simmer Guide (Auto Roast Code 4)

Food	Final Temp.	Approx. Time/Hours	Doneness Display	Comments
<b>Beef</b> Pot Roast	180°F.	5-7	SIM	Add enough liquid to just cover meat. If adding vegetables, make sure they are completely covered by liquid.
	Chili	180°F.	5-8	
<b>Chicken</b> Stewing	180°F.	4-6	SIM	Add 4 cups liquid. Insert probe into meatiest area of inner thigh from below end and parallel to leg. Turn over after 1/2 of time. Same procedure as above.
	Broiler/Fryer	180°F.	3-4	
<b>Ham/Pork</b> Roast	180°F.	4-6	SIM	Add 4 cups liquid.
<b>soup</b> Stock/Vegetable	180°F.	7-10	SIM	Make sure that vegetables and meat are covered by liquid. Stir every 3 hours.
	Split Pea	180°F.	5-7	



# AUTO REHEAT

Auto Reheat lets you touch just 2 pads to bring previously prepared foods to serving temperature. With many leftovers, there is no need to look up reheating times in a cookbook or to rely on guesswork.

By actually sensing the steam that escapes as food heats, this feature automatically adjusts the oven's heating time to various types and amounts of pre-cooked food.

Because all cooking containers must be covered during automatic reheating, this feature is best with foods you want to steam or retain moisture. See Containers and Covers section.

**NOTE: Use of the metal Double Duty™ shelf with Auto Reheat is NOT recommended.**

## Foods Recommended

A wide variety of previously prepared foods including leftovers can be Auto Reheated. Auto Reheat is recommended for single-servings of food or plates of leftovers.

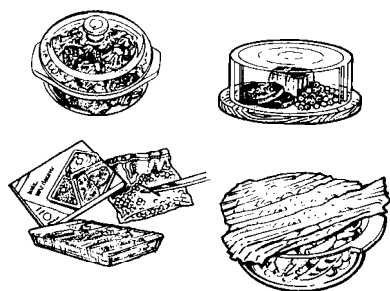

## Foods Not Recommended

Bread products, foods that must be reheated uncovered, foods that require constant attention, and foods calling for a dry look or crisp surface after reheating should not be Auto Reheated. It is best to use Time Cook I & II.

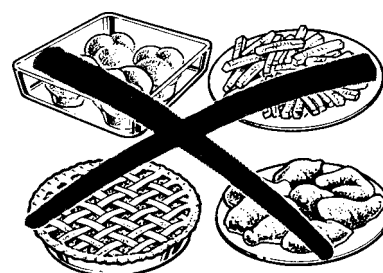

## Easy to Use

Simply touch AUTO REHEAT and START.

## Keep Door Closed

Do not open the oven door while the word "RHEAT" is displayed—steam escaping from the oven can affect reheating performance. If the door is opened, close the door and touch START immediately.

## Example:



Place covered food in oven.  
Touch AUTO REHEAT pad.

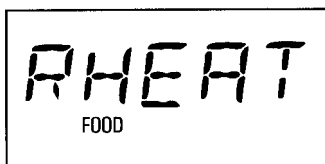

"RHEAT" shows on display and "FOOD" flashes.



After 4 seconds, "START" flashes on display. Touch START pad.



"RHEAT" and "FOOD" are displayed.

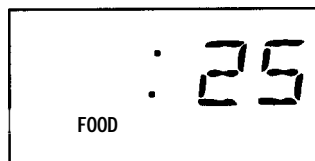

Beep sounds when steam is sensed and "RHEAT" is replaced by time counting down. Rotate or stir food if necessary. Close door and touch START to finish heating. When done, oven displays "End" and beeps every minute until door is opened or CLEAR/OFF is touched.



## Questions & Answers

**Q. If my food is not completely reheated after using Auto Reheat, what should I do?**

A. Use Time Cook in 30-second increments.

**Q. What if I don't fully cover the dish in Auto Reheat?**

A. Oven senses steam too quickly, which shortens the reheating time and leaves food too cool. To complete reheating use the TIME COOK pad.

## AUTO COOK

The Auto Cook feature may be used to eliminate your need to look up cooking time in a cookbook or guess how long to set cooking time. By actually sensing the steam that **escapes as food microwaves, this feature automatically adjusts the oven's cooking time to various types and amounts of food.**

Because most cooking containers must be covered during Auto Cook, this feature is best with foods that you want to steam or retain moisture.

**NOTE: Use of the metal Double Duty™ shelf with Auto Cook is NOT recommended.**

### Foods Recommended

A wide variety of foods including meats, fish, casseroles, vegetables, leftovers and convenience foods can be Auto Cooked.

### Foods Not Recommended

Foods that must be cooked uncovered, foods that require constant attention, foods that require addition of ingredients during cooking, and foods calling for a dry look or crisp surface after cooking should not be Auto Cooked. It is best to Time Cook them.

Foods that microwave best using the temperature probe should be Temp Cooked or Auto Roasted.

### Easy to Use

Simply touch three control pads—AUTO COOK, desired code, and START. The word "AUTO" appears on the display and the sensor is activated to sense steam from food.

### Keep Door Closed

Do not open the oven door while the word "AUTO" is displayed— steam escaping from the oven can affect cooking performance. If the door is opened, close the door and touch START immediately.

### Auto Cook Codes

Auto Cook codes 1 through 8 are designed to give you easy automatic results with a number of foods.

Code 1, designed for reheating foods quickly, turns the oven off automatically as soon as the sensor detects steam from the foods.

When codes 2 through 8 are selected, the oven determines how much additional cooking time is needed after steam has been sensed, automatically switches to TIME COOK and signals. The word "AUTO" on the display is then replaced by countdown numbers indicating remaining cooking time. When the signal is heard, the oven door may be opened for stirring, turning or rotating food.

A guide behind the oven door lists cooking codes for frequently prepared fresh or uncooked foods and appropriate codes are recommended in the Automatic Cooking Control Guide section.

*(continued next page)*



# AUTO COOK

(continued)

## Example:



Place covered food in oven. Touch AUTO COOK pad. "ENTER COOK CODE" flashes on display.



Touch number pad for desired code. "CODE 2" shows. After 4 seconds, "START" flashes on display. Touch START.

The word "AUTO" shows on the display, indicating steam sensor is activated. DO NOT OPEN DOOR. OPENING DOOR MAY AFFECT COOKING PERFORMANCE.



The beep sounds when the steam is sensed and "AUTO" is replaced by cook time. Rotate or stir the food, if necessary. When done, the oven beeps every minute until the door is opened or CLEAR/OFF is touched.

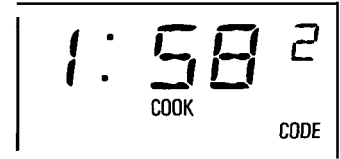

## How to Adjust Auto Cook Codes to Suit Your Taste

By simply adding a 1 after any Auto Cook code number, you can set the oven to cook for 20% less time than the code would regularly provide.

For example, if code 4 cooks your chicken more done than you like it, set code 41 next time and you'll get 20% shorter cooking time.

If you want a longer cooking time than a code provides, add a 9 after the code.

For the chicken in the example at left, code 49 would provide 20% longer cooking time than the regular code 4 would provide.

## Example:



Touch AUTO COOK pad.

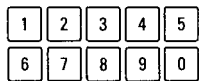

Touch number pads 4 and 1 in that order.



Touch START. DO NOT OPEN DOOR until first oven signal, then rotate dish 1/2 turn if necessary. Close door and touch START to finish cooking.

# CONTAINERS AND COVERS FOR AUTOMATIC COOKING AND AUTOMATIC REHEAT



## Containers and Covers

Appropriate containers and coverings help assure good cooking results.

- Always use microwave-safe containers and cover them with lids or vented plastic wrap. Wonder if it's microwave-safe? Put it to the test described in the Microwaving Tips section.
- **Never use tight-sealing plastic covers**—they can prevent steam from escaping and cause food to overcook.

- **Match the amount of food to the size of the container.** Fill containers at least half full for best results.
- **Be sure the outside of the cooking container and the inside of the microwave oven are dry** before placing food in the oven. Beads of moisture turning into steam can mislead the sensor.
- **Stir or rotate some foods after a beeping signal, if required.** See Automatic Cooking Control Guide.



Use microwave-safe casseroles or bowls for entrees and vegetables. Cover with lids that fit. If lids are not available, use plastic wrap or wax paper. Plastic wrap should be vented over food to allow for escaping steam. Seal by pressing plastic wrap firmly around edges.

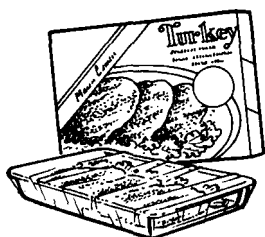

For frozen entrees in paperboard trays, remove tray from box but do not remove film over tray. Thick entrees may take longer to cook—see the Automatic Cooking Control Guide.

For frozen foods in metal trays, remove foil covering and baked goods, reinsert tray into box and close ends of box.

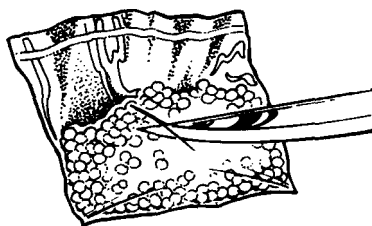

Slit plastic pouches 1 inch as shown above. Break food up thoroughly after oven signals.

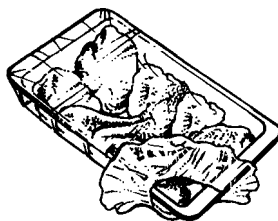

Use oblong or square containers for chicken or corn on the cob. Plastic wrap covering should be vented over food to allow for escaping steam. Seal by pressing plastic wrap firmly around edges.

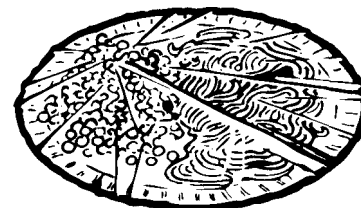

**Paper plates**—while they maybe used for Time and Temperature Cooking and Defrosting, do not use them with automatic cooking. Use microwave-safe plates or bowls for reheating. Cover with plastic wrap or wax paper.

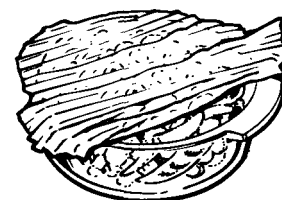

Follow Automatic Cooking Control Guide setting for casseroles. Cover casserole meat and vegetables with sauce. Cool hot ingredients or sauces. If they are not cool, it is better to use Time Cook I & 11.



# AUTOMATIC COOKING CONTROL GUIDE

- Do not open oven door during Auto cycle. When oven signals and countdown time is displayed, door may be opened for stirring, turning or rotating food. To resume cooking, close door and touch START.
- Match the amount of food to the size of container. Fill containers at least 1/2 full.
- Add 1/4 to 1/2 cup water to fresh vegetables.
- Foods should be covered with lid to dish or plastic wrap to prevent spattering to keep oven clean. Spareribs, pot roasts and meat loaf should be covered tightly to ensure even cooking.
- Be sure outside of container and inside of oven are dry.
- After completion of Auto Cook cycle, if food needs additional cooking, return food to oven and use Time Cook I & 11 to finish cooking.  
To adjust cook times to suit individual tastes, add a "1" or "9" to code number when entering Auto Cook Code.
- **Use of Auto Cook feature with DOUBLE DUTY™ metal shelf is not recommended.**

Food	Auto Cook Code	Container	Approx. Time	Comments
<b>Canned Foods</b>				
Thin—water and milk-based soups, sauces, gravies	1	Microwave-safe container matched to size of food.	3 to 4 min. per cup	Cover with lid to dish or plastic wrap.
Thick—chili, beef stew, ravioli, spaghetti, chunky soups	2	Microwave-safe container matched to size of food.	3 to 4 min. per cup	Cover with lid to dish or plastic wrap.
Vegetables—8 to 16 ounces	2	Microwave-safe container matched to amount of food.	4 to 8 min.	Cover with lid to dish or plastic wrap.
<b>Leftovers</b>	2	Plate or microwave-safe container matched to amount of food.	2 to 4 min. per serving	Cover with lid to dish or plastic wrap.
<b>Convenience Foods</b>				
Frozen dinners (with entree and 2 vegetables or vegetable and pasta)	4	Package tray or plate	6 to 10 min.	Cover with plastic lid to plate or leave plastic covering in place on tray.
Frozen dinner entree (individual)				If tray has foil cover, replace with plastic wrap.
Pouch	3	Pouch	3 to 6 min.	
Tray	5	Tray	8 to 11 min.	
Frozen dinner entree (2 to 3 servings)	5	Tray	18 to 22 min.	If tray has foil cover, replace with plastic wrap.
Frozen breakfast entrees	3	Package wrap or tray	3 to 5 min.	
Grocery-Shelf dinner entrees	3	Package	3 to 5 min.	





Food	Auto Cook Code	Container	Approx. Time	Comments
<b>Casseroles</b> Pre-cooked ingredients in sauce, such as tuna noodle, turkey tetrazzini, and franks and beans	6	1 ½- to 3-qt. casserole with lid	20 to 30 min.	When oven signals, stir if necessary.
Uncooked ingredients, such as scalloped potatoes, hamburger patty, stew	7	1X- to 3-qt. casserole with lid	40 to 55 min.	When oven signals, stir if necessary.
<b>Meats, Poultry</b> <b>Seafood</b> Chicken pieces (up to 2½ lbs.)	5	2-qt. oblong glass baking dish	8 to 24 min.	Cover with plastic wrap.
Whole chicken (up to 3 lbs.)	8	2-qt. oblong glass baking dish	30 to 40 min.	Place in cooking bag; cut slits in bag as directed on package.
Fish fillets (1 lb.)	3	2-qt. oblong glass baking dish	7 to 10 min.	Cover with plastic wrap.
Meat loaf (1X lbs.)	8	9x5 x3 inch loaf dish	24 to 28 min.	Cover with plastic wrap.
Hamburger patties (4)	3	8 inch square dish	7 to 9 min.	Cover with plastic wrap.
Sausage patties (12 oz.)	3	2-qt. oblong glass baking dish	7 to 9 min.	When oven signals, turn patties over.
Pork chops (4, 1/2 to 3/4 inch thick)	8	2-qt. oblong glass baking dish	30 to 35 min.	Cover with plastic wrap
Shrimp (up to 1lb.)	2	2-qt. oblong glass baking dish	4 to 7 min.	Cover with plastic wrap.
<b>Vegetables</b> Frozen, 10-oz. block	2	1-qt. casserole with lid	7 to 10 min.	Add amount of water recommended on package.
Frozen, 10-oz. pouch	3	Pouch on microwave-safe plate	8 to 10 min.	Cut slits in pouch as directed on package.
Baking potatoes (4, 6 to 8 oz. each)	4	8 inch square dish	12 to 16 min.	Pierce skin with fork. Arrange around sides of dish; cover with plastic wrap.
Cubed potatoes (up to 2 lbs.)	4	2-qt. casserole with lid	20 to 30 min.	Add 1 to 1 ½ cups water.
Fresh vegetables, such as carrots, brussels sprouts, broccoli, cauliflower, summer and winter squash, green beans	4	IX- to 2-qt. casserole with lid	13 to 15 min.	Add 1/4 to 1/2 cup water. When oven signals, stir if necessary.
<b>Fruit</b> Baked apples, pears (4)	2	2-qt. casserole with lid	12 to 14 min.	Add 2 tablespoons water per piece of fruit to dish.



# HOW TO USE THE DOUBLE DUTY™ SHELF

- Use the shelf only when cooking food on 2 levels. Food microwaves best when placed directly on the oven floor.
- Do not store or cook with shelf on floor of oven. Product damage may result.
- Use pot holders when handling metal shelf and cookware. They may be hot.
- Do not store microwave browning dish on metal shelf.
- Use of Double Duty™ shelf with Auto Cook, Auto Reheat or Popcorn program is not recommended.

The wire shelf is specifically designed for added capacity in your microwave oven. Now more than one food may be heated or reheated and ready to serve at the same time.

Batters and dough foods and also uncooked foods which need to be prepared from scratch should be cooked without the oven shelf.

## Positioning the Shelf

To position the DOUBLE DUTY™ shelf, tip the back slightly and fit the shelf support guides **onto** the support guides located on each side of the oven in the rear.

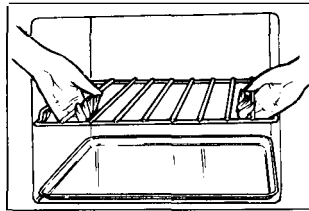

Next, lower the front until the shelf support guides fit **onto** the support guides located at each side of the oven in the front.

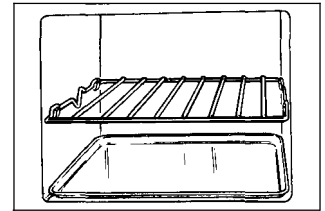

When properly positioned, the shelf should fit snugly in place, be level and not touch the back or side wall of the oven.

**If arcing occurs when using the shelf to cook more than one food at the same time, turn the oven off. Make sure the shelf is not touching oven walls. To prevent arcing, remove the shelf when you are not using it.**

## How to Reheat Several Different Types of Foods Together

When heating several different types of food together, foods which should be served hot must be placed on the shelf, while foods which need *only* to be warmed should be placed on the oven floor. This is because microwave energy enters the oven from the top only. Also, it is important to remember that foods absorb microwave energy at different rates. Rates can be affected by the size of the food, and its starting temperature.

Because of the varying rates, you may need to start reheating a large or dense food a few minutes ahead of time, then add other smaller or less dense foods. Alternately, if one of the foods you are heating seems undercooked but the others are heated satisfactorily, let the underheated food continue cooking.

Heat or reheat different types of food at High ( 10). To determine heating times, add times for all foods together. After half of time, stir or rearrange foods

(do not reverse positions). Check foods (especially those on the oven floor) after 3/4 of total time and remove any which are done. Continue cooking others.

Place on shelf large or dense foods, which need the most heating, such as leftover fried chicken, casseroles of canned or leftover vegetables, rice or pasta. Place on floor those foods which need only be warmed, such as bakery pies, rolls, muffins or breads.

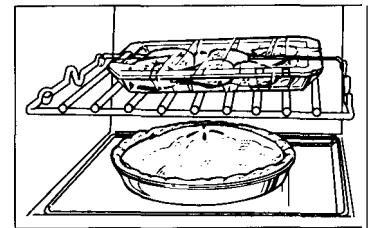

**Pop popcorn on the microwave oven floor only.** Popcorn placed on the oven shelf will not pop properly. Use a special microwave popcorn accessory or prepackaged popcorn labeled for use in microwave ovens.

# GLOSSARY OF MICROWAVE TERMS



**When adapting recipes for the microwave, it is best to start with a familiar recipe. Knowing how the food should look and taste will help when adapting recipes for microwaving. Foods that require browning or crisp, dry surfaces will cook better in regular ovens.**

- Moist foods, such as vegetables, fruits, poultry and seafood, microwave well.
- Rich foods, such as bar cookies, moist cakes and candies, are suitable for microwaving because of their high fat and sugar content.
- Reduce regular oven cooking times by one-half to one-third. Check food after minimum time to avoid overcooking.
- Small amounts of butter or oil can be used for flavoring, but are not needed to prevent sticking.
- Seasonings may need to be reduced. Salt meats and vegetables after cooking.

**Covering.** In both regular baking and microwave cooking, covers hold in moisture, allow for more even heating and reduce cooking time. In regular ovens, partial covering allows excess steam to escape. Venting plastic wrap or covering with wax paper serves the same purpose when microwaving.

**Venting.** After covering a dish with plastic wrap, you vent the plastic wrap by turning back one corner so excess steam can escape.

**Arranging Food in Oven.** When baking in regular ovens, you position foods, such as cake layers or potatoes, so hot air can flow around them. When microwaving, you arrange foods in a ring, so that all sides are exposed to microwave energy.

**Stirring.** In range-top cooking, you stir foods up from the bottom to heat them evenly. When microwaving, you stir cooked portions from the outside to the center. Foods that require constant stirring will need only occasional stirring when microwaving.

**Turning Over.** In range-top cooking, you turn over foods, such as hamburgers, so both sides can directly contact the hot pan. When microwaving, turning is often needed during defrosting or when cooking certain foods, such as frozen hamburgers.

**Standing Time.** When you cook with regular ovens, foods such as roasts or cakes are allowed to stand to finish cooking or to set. Standing time is especially important in microwave cooking. Note that a microwaved cake is not placed on a cooling rack.

**Shielding.** In a regular oven, you shield chicken breasts or baked foods to prevent over-browning. When microwaving, you use small strips of foil to shield thin parts, such as the tips of wings and legs on poultry, which would cook before larger parts.

**Arcing.** Sparks caused by too much metal in the microwave oven or metal touching the side of the oven or foil that is not molded to food.

**Prick Foods to Release Pressure.** Steam builds up pressure in foods that are tightly covered by a skin or membrane. Prick foods, such as potatoes (as you do before regular oven cooking), egg yolks and chicken livers, to prevent bursting.

**Rotating.** Occasionally, repositioning a dish in the oven helps food cook more evenly. To rotate 1/2 turn, turn the dish until the side that was to the back of the oven is to the front. To rotate 1/4 turn, turn the dish until the side that was to the back of the oven is to the side.

## Basic Microwave Guidelines

**Density of Food.** In both regular baking and microwave cooking, dense foods, such as potatoes, take longer to cook than light, porous foods, such as rolls, bread or pieces of cake.

**Round Shapes.** Since microwaves penetrate foods to about one inch from top, bottom and sides, round shapes and rings cook more evenly. Corners receive more energy and may overcook. This may also happen when cooking in a regular oven.

**Delicacy.** Foods with a delicate texture, such as custards, are best cooked at lower power settings to avoid toughening.

**Natural Moisture** of food affects how it cooks. Very moist foods cook evenly because microwave energy is attracted to water molecules. Food that is uneven in moisture should be covered or allowed to stand so it heats evenly.

**Piece Size.** Small pieces cook faster than large ones. Pieces that are similar in size and shape cook more evenly. With large pieces of food, reduce the power setting for even cooking.

**Shape of Food.** In both types of cooking, thin areas cook faster than thick areas. This can be controlled in microwaving by placing thick pieces near the outside edge and thin pieces in the center.

**Starting Temperature.** Foods taken from the freezer or refrigerator take longer to cook than foods at room temperature. Timings in our recipes are based on the temperatures at which you normally store the foods.

**Quantity of Food.** In both types of cooking, small amounts usually take less time than large amounts. This is most apparent in microwave cooking, where time is directly related to the number of servings.

**Shelf** (on models so equipped). Use the shelf to heat more than one dish at a time. Take the shelf out when you are not using it.



# HEATING OR REHEATING GUIDE

**NOTE:** Use Power Level High (10) unless otherwise noted.

1. Directions below are for heating or reheating already-cooked foods stored in refrigerator or at room temperature. Use microwave-safe cookware.
2. Cover most foods for fastest heating. Exceptions are some sandwiches, griddle foods and baked items.
3. Bubbling around edges of dish is normal, since the center is the last to heat. Foods heated to 160°F. to 165°F. will provide safe,

palatable results. Adjust temperatures to suit your personal taste. Let foods stand a few minutes before serving.

4. Be sure foods are heated throughout before serving. Steaming or bubbling around edges of dish does not necessarily mean food is heated throughout.

If you use a meat thermometer while cooking, make sure it is safe for use in microwave ovens.

Item	Amount	Power Level	Time
<b>Bakery Foods</b>			
Cake, coffee cake, doughnuts, sweet rolls, nut or fruit bread	1 piece 9 inch cake or 12 rolls or doughnuts	Low (3) Low (3)	1/2 to 1 min. 1 1/2 to 4 min.
Dinner rolls, muffins	1 6 to 8	Medium (5) Medium (5)	1/4 to 1/2 min. 1/2 to 2 min.
Pie: fruit, nut or custard; 1 slice= 1/8 of 9 inch pie (use minimum time for custard)	1 slice 9 inch pie	 Meal-High (7)	1/2 to 1 min. 4 1/2 to 7 min.
<b>Beverages</b>			
Cocoa, other milk based drinks (6 oz. per cup)	1 to 2 cups	Meal-High (7)	2 1/2 to 6 min.
Coffee, other water-based drinks (6 oz. per cup)	1 to 2 cups		1/2 to 3 min.
<b>Meats and Main Dishes</b>			
Chicken pieces	1 to 2 pieces		1 1/2 to 3 min.
Hamburgers or meatloaf (4 oz. per serving)	1 to 2 servings		1 1/2 to 3 min.
Hot dogs and sausages	1 to 2		1/2 to 1 min.
Rice and pasta (2/3-3/4 cup per serving)	1 to 2 servings		1/2 to 3 min.
Saucy, main dishes: chop suey, spaghetti, creamed chicken, chili, stew, macaroni and cheese, etc. (3/4- 1 cup per serving)	1 to 2 servings		2 1/2 to 5 min.
Steaks, chops, ribs, meat pieces	1 to 2 servings		1 1/2 to 4 min.
Thinly-sliced meat (3 to 4 oz. per serving)	1 to 2 servings		1/2 to 3 min.
Topped or mixed with sauce (2/3-3/4 cup per serving)	1 to 2 servings		2 1/2 to 5 min.
Tip: Cover saucy main dishes with plastic wrap. Cover other main dishes and meats with wax paper. When heating or reheating 3 to 4 servings of meat slices or pieces, rotate dish 1/2 turn after half of cooking time.			
<b>Plate of Leftovers</b>			
Meat plus 2 vegetables	1 plate		2 1/2 to 4 min.
Tip: Cover plate of food with wax paper or plastic wrap.			
<b>Sandwiches</b>			
Meat-cheese filling: with 2 slices of bread	1 to 2 servings	Meal-High (7)	1/2 to 3 min.
Moist filling: Sloppy Joes, barbecue, ham salad, etc. in bun ( 1/3 cup per serving)	1 to 2 servings	Meal-High (7)	1/2 to 2 min.
Tip: Use paper towel or napkin to cover sandwiches.			
<b>soups</b>			
Milk-based (6 oz. per serving)	1 to 2 servings	Meal-High (7)	1 1/2 to 3 min.
Water-based (6 oz. per serving)	1 to 2 servings		1 to 3 min.
Tip: Cover soups with wax paper or plastic wrap.			
<b>Vegetables</b>			
Large pieces or whole: asparagus spears, corn on the cob, etc.	1 to 2 servings		1/2 to 2 min.
Mashed (1/2 cup per serving)	1 to 2 servings		1/2 to 2 min.
Small pieces: peas, beans, corn, etc. ( 1/2 cup per serving)	1 to 2 servings		1/2 to 2 min.
Tip: Cover vegetables for most even heating.			

# DEFROSTING GUIDE



1. Food packaged in paper or plastic may be defrosted without unwrapping. If food is foil wrapped, remove foil and place food in cooking dish for defrosting. Most food defrosts well using Defrost (3). For more even defrosting of larger foods, such as beef, lamb and veal roasts, use Warm (1).
2. After first half of defrosting time, unwrap package and check food. Turn food over, if necessary; break apart or separate food if possible. Shield any warm areas with small pieces of foil.
3. Be sure large meats are completely defrosted before cooking.
4. When defrosted, food should be cool but softened in all areas. If still slightly icy, return to microwave oven very briefly, or let stand a few minutes.

Food	Time	Comments
<b>Breads, Cakes</b> [Power Level: Defrost (3)]		
Bread, buns or rolls (1 piece)	1/2 min.	
Sweet rolls (approx. 12 oz.)	3 to 6 min.	Rearrange after half of time.
<b>Fish and Seafood</b> [Power Level: Defrost (3)]		
Fillet, frozen (1 lb.)	8 to 12 min.	
Shellfish, small pieces (1 lb.)	5 to 8 min.	Place block in casserole. Turn over and breakup after first half of time.
<b>Fruit</b> [Power Level: Defrost (3)]		
Plastic pouch—1 to 2 (10-oz. package)	3 to 7 min.	
<b>Meat</b> [Power Level: Defrost (3)]		
Bacon (1 lb.)	3 to 6 min. per lb.	Place unopened package in oven. Let stand 5 minutes after defrosting.
Franks (1 lb.)	3 to 6 min.	Place unopened package in oven. Microwave just until franks can be separated. Let stand 5 minutes, if necessary, to complete defrosting.
Ground meat (1 lb.)	5 to 8 min.	Turn meat over after first half of time.
Roast: beef, lamb, veal, pork	10 to 16 min. per lb.	Use Power Level Warm (1).
<b>Steaks</b> , chops and cutlets	5 to 10 min. per lb.	Place unwrapped meat in cooking dish. Turn over after first half of time and shield warm areas with foil. After second half of time, separate pieces with table knife. Let stand to complete defrosting.
<b>Poultry</b> [Power Level: Defrost (3)]		
<b>Chicken</b> , broiler-fryer, cut up (2½ to 3 lbs.)	16 to 22	Place wrapped chicken in dish. Unwrap and turn over after first half of time. After second half of time, separate pieces and place in cooking dish. Microwave 2 to 4 minutes more, if necessary. Let stand a few minutes to finish defrosting.
<b>Chicken</b> , whole (2½ to 3 lbs.)	22 to 28	Place wrapped chicken in dish. After first half of time, unwrap and turn chicken over. Shield warm areas with foil. To complete defrosting, run cool water in cavity until giblets can be removed.
<b>Cornish hen</b>	9 to 16 min. per lb.	Place unwrapped hen in oven breast-side-up. Turn over after first half of time. Run cool water in cavity until giblets can be removed.
<b>Turkey breast</b> (4 to 6 lbs.)	5 to 10 min. per lb.	Place unwrapped breast in microwave-safe dish breast-side-down. After first half of time, turn breast-side-up and shield warm areas with foil. Defrost for second half of time. Let stand 1 to 2 hours in refrigerator to complete defrosting.



# COOKING GUIDE

NOTE: Use Power Level High (10) unless otherwise noted.

## Vegetables

Vegetable	Amount	Time	Comments
<b>Asparagus</b> (frozen spears)	1 lb.	7 to 10 min., Meal-High (7)	In 1 1/2-qt. oblong glass baking dish, place 1/4 cup water. Rotate dish after half of time.
(frozen spears)	10-oz. package	5 to 8 min.	In 1-qt. casserole.
<b>Beans</b> (fresh green)	1 lb. cut in half	12 to 17 min.	In 1 1/2-qt. casserole, place 1/2 cup water.
(frozen green)	10-OZ. package	5 to 9 min.	In 1-qt. casserole, place 2 tablespoons water.
(frozen lima)	10-OZ. package	5 to 9 min.	In 1-qt. casserole, place 1/4 cup water.
<b>Beets</b> (fresh, whole)	1 bunch	18 to 25 min.	In 2-qt. casserole, place 1/2 cup water,
<b>Broccoli</b> (fresh cut)	1 bunch (1/4 to 1 1/2 lbs.)	7 to 10 min.	In 2-qt. casserole, place 1/2 cup water.
(fresh spears)	1 bunch (1/4 to 1 1/2 lbs.)	9 to 13 min.	In 2-qt. oblong glass baking dish, place 1/4 cup water. Rotate dish after half of time.
(frozen, chopped)	10-oz. package	5 to 8 min.	In 1-qt. casserole.
(frozen spears)	10-oz. package	5 to 8 min.	In 1-qt. <i>casserole</i> , place 3 tablespoons water.
<b>Cabbage</b> (fresh)	1 medium head (about 2 lbs.)	8 to 11 min.	In 1X-or 2-qt. casserole, place 1/4 cup water.
(wedges)		7 to 10 min.	In 2-or 3-qt. casserole, place 1/4 cup water.
<b>Carrots</b> (fresh, sliced)	1 lb.	6 to 9 min.	In 1 1/2-qt. casserole, place 1/4 cup water.
(frozen)	10-oz. package	5 to 8 min.	In 1-qt. casserole, place 2 tablespoons water.
<b>Cauliflower</b> (flowerets)	1 medium head	9 to 14 min.	In 2-qt. casserole, place 1/2 cup water.
(fresh, whole)	1 medium head	9 to 17 min.	In 2-qt. casserole, place 1/2 cup water.
(frozen)	10-oz. package	5 to 8 min.	In 1-qt. casserole, place 2 tablespoons water.
<b>Corn</b> (frozen kernel)	10-OZ. package	4 to 8 min.	In 1-qt. casserole, place 2 tablespoons water.
<b>Corn on the cob</b> (fresh)	1 to 5 ears	3 to 5 min per ear	In 2-qt. oblong glass baking dish, place corn. If com is in husk, use no water; if com has been husked, add 1/4 cup water. Rearrange after half of time.
(frozen)	1 ear 2 to 6 ears	5 to 7 min. 2 to 4 min. per ear	Place in 2-qt. oblong glass baking dish. Cover with vented plastic wrap. Rearrange after half of time.
<b>Mixed, vegetables</b> (frozen)	10-OZ. package	4 to 8 min.	In 1-qt. casserole, place 3 tablespoons water.
<b>Peas</b> (fresh, shelled)	2 lbs. unshelled	9 to 12 min.	In 1-qt. casserole, place 1/4 cup water.
(frozen)	10-oz. package	4 to 8 min.	In 1-qt. casserole, place 2 tablespoons water
<b>Potatoes</b> (fresh, cubed, white)	4 potatoes (6 to 8 oz. each)	11 to 14 min.	Peel and cut into 1 inch cubes. Place in 2-qt. casserole with 1/2 cup water. Stir after half of time.
(fresh, whole, sweet or white)	1 (6 to 8 oz. each)	2 to 5 min.	Pierce with cooking fork. Place on paper towel on glass cooking tray, 1 inch apart in circular arrangement. Let stand 5 minutes.
<b>Spinach</b> (fresh)		5 to 8 min.	In 2-qt. casserole, place washed spinach.
(frozen, chopped and leaf)	10-OZ. package	5 to 8 min.	In 1-qt. casserole, place 3 tablespoons water.
<b>Squash</b> (fresh, summer and yellow)	1 lb. sliced	4 to 7 min.	In 1 1/2-qt. casserole, place 1/4 cup water.
(winter, acorn or butternut)	1 to 2 squash (about 1 lb. each)	7 to 11 min.	Cut in half and remove fibrous membranes. In 2-qt. oblong glass baking dish, place squash cut-side-down. Turn cut-side-up after 4 minutes.

# CARE AND CLEANING

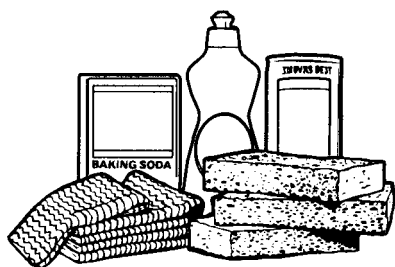
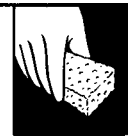

**Keep your oven clean and sweet-smelling.** Opening the oven door a few minutes after cooking helps air out the inside. An occasional thorough wiping with a solution of baking soda and water keeps the inside fresh.

**Don't use sharp-edged utensils** on your oven. The inside and outside oven walls can be scratched. The control panel can be damaged. **BE CERTAIN POWER IS OFF BEFORE CLEANING ANY PART OF THIS OVEN.**

## How to Clean the Inside

**Walls, floor and mode stirrer cover.** Some spatters can be removed with a paper towel, others may require a damp cloth. Remove greasy spatters with a sudsy cloth, then rinse with a damp cloth. Do not use abrasive cleaners on oven walls. **NEVER USE A COMMERCIAL OVEN CLEANER ON ANY PART OF YOUR MICROWAVE OVEN.**

**Door (inside).** Window: Wipe up spatters daily and wash when soiled with a damp cloth. Rinse thoroughly and dry.

Metal and plastic parts on door: Wipe frequently with a damp cloth to remove all soil. **DO NOT USE ABRASIVES, SUCH AS CLEANING POWDERS OR STEEL AND PLASTIC PADS. THEY WILL DAMAGE THE SURFACE.**

**Glass Cooking Tray.** Occasionally it is necessary to remove the cooking tray for cleaning of the tray or oven. To prevent breakage, do not place tray into water just after cooking. Wash it carefully in warm, sudsy water or in the dishwasher. The tray can be broken if dropped. Remember, do not operate the oven without the cooking tray in place.

**Special note when using Brown 'N Sear Dish:** If grease is present, high heat generated on bottom of a Brown 'N Sear dish may cause the grease to burn onto the oven tray. This may be removed with a cleanser such as Bon Ami® brand cleanser.

After using Bon Ami® brand cleanser, rinse and dry thoroughly, following instructions on can. Do not use Bon Ami® brand cleanser on the painted surfaces such as the walls. It may scratch the paint.

**Automatic Temperature Probe.** Probe is sturdy, but care should be taken in handling. Do not twist or bend; avoid dropping temperature probe.

Clean as soon after using as possible. To clean, wipe with sudsy cloth, then rub lightly with plastic scouring ball if necessary. Rinse and dry or wash in dishwasher.

**DOUBLE DUTY™ shelf.** Your shelf accessory is designed for use in a microwave oven only; do not use in a regular oven. Do not use a browning dish with the shelf. Arcing could occur.

Clean shelf with mild soap and water or in the dishwasher. **Do not clean shelf in a self-cleaning oven.**

## How to Clean the Outside

**Case.** Clean the outside of your oven with soap and damp cloth, rinse with a damp cloth and then dry. Wipe the window clean with a damp cloth. Chrome trim is best wiped with a damp cloth and then with a dry towel.

**Control Panel.** Wipe with a damp cloth. Dry thoroughly. Do not use cleaning sprays, large amounts of soap and water, abrasives or sharp objects on the panel—they can damage it.

**Door Surface.** When cleaning surfaces of door and oven that come together on closing the door, use only mild, non-abrasive soaps or detergents applied with a sponge or soft cloth.

**Power Cord.** If the cord becomes soiled, unplug and wash with a damp cloth. For stubborn spots, sudsy water may be used, but be certain to rinse with a damp cloth and dry thoroughly before plugging cord into outlet.



## OVEN LAMP REPLACEMENT

First unplug the oven. Then remove lamp compartment cover by removing screw which holds cover in place. Cover is located on the side of the outer case.

Replace with 25-watt appliance bulb. (It is available in drugstores and hardware stores.) Replace compartment cover. Plug in the oven.

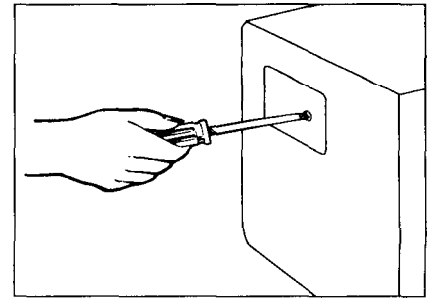

## GROUNDING INSTRUCTIONS

This appliance must be grounded. In the event of an electrical short circuit, grounding reduces the risk of electric shock by providing an escape wire for the electric current. This appliance is equipped with a power cord having a grounding wire with a grounding plug. The plug must be plugged into an outlet that is properly installed and grounded. (Fig. 1)

**WARNING**—improper use of the grounding plug can result in a risk of electric shock.

Consult a qualified electrician or service technician if the grounding instructions are not completely understood, or if doubt exists as to whether the appliance is properly grounded.

Where a standard two-prong wall receptacle is encountered, it is your personal responsibility and obligation to have it replaced with a properly grounded three-prong wall receptacle.

Do not under any circumstances cut or remove the third (ground) prong from the power cord.

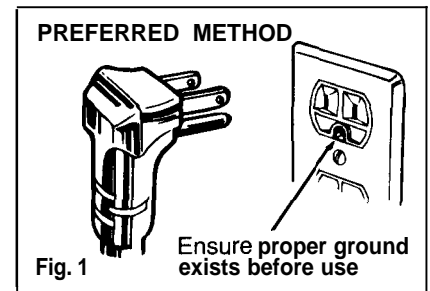





## Use of Adapter Plugs

### Usage situations where appliance's power cord will be disconnected infrequently.

Because of potential safety hazards under certain conditions, we strongly recommend against the use of an adapter plug. However, if you still elect to use an

adapter, where local codes permit, a TEMPORARY CONNECTION may be made to a properly grounded two-prong wall receptacle by the use of a UL listed adapter (Fig. 2) which is available at most local hardware stores.

The larger slot in the adapter must be aligned with the larger slot in the wall receptacle to provide proper polarity in the connection of the power cord.

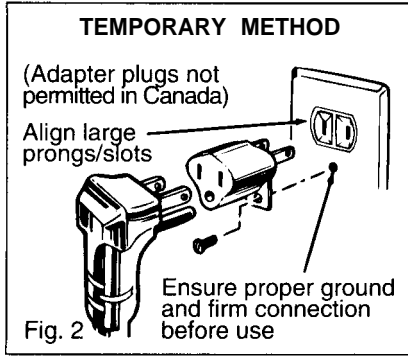

**Caution:** Attaching the adapter ground terminal to the wall receptacle cover screw does not ground the appliance unless the cover screw is metal, and not insulated, and the wall receptacle is grounded through the house wiring. You should have the circuit checked by a qualified electrician to make sure the receptacle is properly grounded.

When disconnecting the power cord from the adapter, always hold the adapter with one hand. If this is not done, the adapter ground terminal is very likely to break with repeated use. Should this happen, DO NOT USE the appliance until a proper ground has again been established.

### Usage situations where appliance's power cord will be disconnected frequently.

**Do not use an adapter plug** in these situations because frequent disconnection of the power cord places undue strain on the adapter and leads to eventual failure of the adapter ground terminal. You should have the two-prong wall receptacle replaced with a three-prong (grounding) receptacle by a qualified electrician before using the appliance.

## Use of Extension Cords

A short power-supply cord is provided to reduce the risks resulting from becoming entangled in or tripping over a longer cord.

Longer cord sets or extension cords are available and may be used if care is exercised in their use.

If a long cord or extension cord is used—

1. The marked electrical rating of the cord set or extension cord should be at least as great as the electrical rating of the appliance;
2. The extension cord must be a grounding-type 3-wire cord and it must be plugged into a 3-slot outlet;

3. The longer cord should be arranged so that it will not drape over the counter top or tabletop where it can be pulled on by children or tripped over unintentionally.

If you use an extension cord, the interior light may flicker and the blower sound may vary when the microwave oven is on. Cooking times may be longer, too.





## QUESTIONS? USE THIS PROBLEM SOLVER

PROBLEM	POSSIBLE CAUSE
OVEN WILL NOT COME ON	<ul style="list-style-type: none"><li>• A fuse in your home may be blown or the circuit breaker tripped. Replace fuse or reset circuit breaker.</li><li>• Unplug your microwave oven, then plug it back in.</li><li>• Make sure 3-prong plug on oven is fully inserted into wall receptacle.</li></ul>
CONTROL PANEL LIGHTED, YET OVEN WILL NOT START	<ul style="list-style-type: none"><li>• Door not securely closed,</li><li>• <b>START pad</b> must be touched after entering cooking selection.</li><li>• Another selection entered already in oven and <b>CLEAR/OFF</b> pad not touched to cancel it.</li><li>• Make sure you have entered cooking time after touching <b>TIME COOK I &amp; 11</b> pad.</li><li>• <b>CLEAR/OFF</b> pad was touched accidentally. Reset cooking program and touch <b>START</b> pad.</li><li>• Make sure you have entered a temperature <b>after</b> touching <b>TEMP COOK &amp; HOLD</b> pad.</li><li>• Make sure you have entered a code number after touching <b>AUTO ROAST</b> or <b>AUTO COOK</b> pad.</li></ul>
"PROBE" APPEARS ON DISPLAY	<ul style="list-style-type: none"><li>• Probe has been forgotten or not seated properly in oven wall when using <b>Temp Cook &amp; Hold</b> or <b>Auto Roast</b> functions.</li></ul>
"Error" APPEARS ON DISPLAY	<ul style="list-style-type: none"><li>• During Auto Cook, Auto Reheat or Popcorn program, the door was opened before steam could be detected, or steam was not detected in <b>maximum</b> time.</li><li>• No steam was detected by sensor within four minutes and 10 seconds after start of Popcorn program.</li></ul>

### All these things are normal with your microwave oven:

- Steam or vapor escaping from around the door.
- Light reflection around door or outer case.
- Dimming oven light and change in blower sound may occur while operating at power levels other than high.
- Dull thumping sound while oven is operating.
- Some TV-Radio interference might be noticed while using your microwave oven. It's similar to the interference caused by other small appliances and does not indicate a problem with your oven.

If you need more help...call, toll free: GE Answer Center®/ 800.626.2000/ consumer information service

# We'll Be There

With the purchase of your new GE appliance, receive the assurance that if you ever need information or assistance from GE, we'll be there. All you have to do is call—toll-free!

## ***In-Home Repair Service*** ***800-GE-CARES (800-432-2737)***

AGE consumer service professional will provide expert repair service, scheduled at a time that's convenient for you. Many GE Consumer Service company-operated locations offer you service today or tomorrow, or at your convenience (7:00 a.m. to 7:00 p.m. weekdays, 9:00 a.m. to 2:00 p.m. Saturdays). Our factory-trained technicians know your appliance inside and out—so most repairs can be handled in just one visit.

## ***GE Answer Center®*** ***800.626.2000***

Whatever your question about any GE major appliance, GE Answer Center® information service is available to help. Your call—and your question—will be answered promptly and courteously. And you can call any time. GE Answer Center® service is open 24 hours a day, 7 days a week.

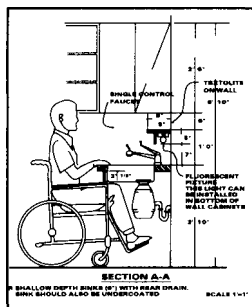

## ***For Customers With Special Needs...***

8086262000

Upon request, GE will provide Braille controls for a variety of GE appliances, and a brochure to assist in planning a barrier-free kitchen for persons with limited mobility. To obtain these items, free of charge, call 800.626.2000.

Consumers with impaired hearing or speech who have access to a TDD or a conventional teletypewriter may call 800-TDD-GEAC (800-833-4322) to request information or service.

## ***Service Contracts*** ***800-626-2224***

You can have the secure feeling that GE Consumer Service will still be there after your warranty expires. Purchase a GE contract while your warranty is still in effect and you'll receive a substantial discount. With a multiple-year contract, you're assured of future service at today's prices.

## ***Parts and Accessories*** ***800-626-2002***

Individuals qualified to service their own appliances can have needed parts or accessories sent directly to their home. The GE parts system provides access to over **47,000** parts... and all GE Genuine Renewal Parts are fully warranted. VISA, MasterCard and Discover cards are accepted.

User maintenance instructions contained in this booklet cover procedures intended to be performed by any user. **Other servicing generally should be referred to qualified service personnel. Caution must be exercised, since improper servicing may cause unsafe operation.**

# YOUR GE MICROWAVE OVEN WARRANTY

**Staple sales slip or cancelled check here. Proof of original purchase date is needed to obtain service under warranty.**

## WHAT IS COVERED

### FULL ONE-YEAR WARRANTY

For one year from date of original purchase, we will provide, free of charge, parts and service labor in your home to repair or replace **any part of the microwave oven** that fails because of a manufacturing defect.

### LIMITED ADDITIONAL NINE-YEAR WARRANTY

For the second through tenth year from date of original purchase, we will provide, free of charge, a replacement **magnetron tube** if the magnetron tube fails because of a manufacturing defect. You pay for the service trip to your home and service labor charges.

This warranty is extended to the original purchaser and any succeeding owner for products purchased for ordinary home use in the 48 mainland states, Hawaii and Washington, D.C. In Alaska the warranty is the same except that it is LIMITED because you must pay to ship the product to the service shop or for the service technician's travel costs to your home.

All warranty service will be provided by our Factory Service Centers or by our authorized Customer Care<sup>®</sup> servicers during normal working hours.

Should your appliance need service, during warranty period or beyond, call 800-GE-CARES (800-432-2737).

## WHAT IS NOT COVERED

- Service trips to your home to teach you how to use the product.

**Read your Use and Care material.** If you then have any questions about operating the product, please contact your dealer or our Consumer Affairs office at the address below, or call, toll free:

GE Answer Center<sup>®</sup>  
800.626.2000  
consumer information service

- Improper installation.

If you have an installation problem, contact your dealer or installer. You are responsible for providing adequate electrical, gas, exhausting and other connecting facilities.

- Replacement of house fuses or resetting of circuit breakers.
- Failure of the product if it is used for other than its intended purpose or used commercially.

- Damage to product caused by accident, fire, floods or acts of God.

WARRANTOR IS *NOT* RESPONSIBLE FOR CONSEQUENTIAL DAMAGES.

Some states do not allow the exclusion or limitation of incidental or consequential damages, so the above limitation or exclusion may not apply to you. This warranty gives you specific legal rights, and you may also have other rights which vary from state to state. To know what your legal rights are in your state, consult your local or state consumer affairs office or your state's Attorney General.

**Warrantor: General Electric Company**

**If further help is needed concerning this warranty, write:  
Manager—Consumer Affairs, GE Appliances, Louisville, KY 40225**

Part No. 164 D2588P144

Pub. No. 49-8345

JEM3.

## Free Manuals Download Website

<http://myh66.com>

<http://usermanuals.us>

<http://www.somanuals.com>

<http://www.4manuals.cc>

<http://www.manual-lib.com>

<http://www.404manual.com>

<http://www.luxmanual.com>

<http://aubethermostatmanual.com>

Golf course search by state

<http://golfingnear.com>

Email search by domain

<http://emailbydomain.com>

Auto manuals search

<http://auto.somanuals.com>

TV manuals search

<http://tv.somanuals.com>