

microwave oven

700 watts

model JES0734PMRR

Safety Instructions 2-4

Operating Instructions

Features 5

Quick Start 5

Changing Power Levels 6

Time Features 6-9

Convenience Features 9-10

Other Features 10

Helpful Information

Microwave Terms 11

Care and Cleaning 11-12

If Something Goes Wrong 12

Things That Are Normal 12

Microwave Oven Warranty 15

Consumer Support Back cover



ge.com

3513913700 49-40546-2 07-07 JR

IMPORTANT SAFETY INSTRUCTIONS. READ ALL INSTRUCTIONS BEFORE USING.

⚠ WARNING!

For your safety, the information in this manual must be followed to minimize the risk of fire or explosion, electric shock, or to prevent property damage, personal injury, or loss of life.

PRECAUTIONS TO AVOID POSSIBLE EXPOSURE TO EXCESSIVE MICROWAVE ENERGY

- (a) **Do Not Attempt** to operate this oven with the door open since open-door operation can result in harmful exposure to microwave energy. It is important not to defeat or tamper with the safety interlocks.
- (b) **Do Not Place** any object between the oven front face and the door or allow soil or cleaner residue to accumulate on sealing surfaces.
- (c) **Do Not Operate** the oven if it is damaged. It is particularly important that the oven door close properly and that there is no damage to the:
 - (1) door (bent),
 - (2) hinges and latches (broken or loosened),
 - (3) door seals and sealing surfaces.
- (d) **The Oven Should Not** be adjusted or repaired by anyone except properly qualified service personnel.

IMPORTANT SAFETY INSTRUCTIONS

When using electrical appliances, basic safety precautions should be followed, including the following:

- Read and follow the specific precautions in the "Precautions to Avoid Possible Exposure to Excessive Microwave Energy" section above.
- This appliance must be grounded. Connect only to a properly grounded outlet. See the Grounding Instructions section on page 4.
- Install or locate this appliance only in accordance with the provided installation instructions.
- Be certain to place the front surface of the door three inches or more back from the countertop edge to avoid accidental tipping of the appliance in normal usage.
- Do not mount this appliance over a sink.
- Do not mount the microwave oven over or near any portion of a heating or cooking appliance.
- Do not store anything directly on top of the microwave oven surface when the microwave oven is in operation.

- Do not operate any heating or cooking appliance beneath this microwave.
- Do not operate this appliance if it has a damaged power cord or plug, if it is not working properly, or if it has been damaged or dropped.
- Do not cover or block any openings on the appliance.
- Use this appliance only for its intended use as described in this manual. Do not use corrosive chemicals or vapors in this appliance. This microwave oven is specifically designed to heat, dry or cook food, and is not intended for laboratory or industrial use.

Use this appliance only for its intended purpose as described in this Owner's Manual.

- This microwave oven is not approved or tested for marine use.
- Do not store this appliance outdoors. Do not use this product near water—for example, in a wet basement, near a swimming pool, near a sink or in similar locations.
- Keep power cord away from heated surfaces.
- Do not immerse power cord or plug in water.
- Do not let power cord hang over edge of table or counter.
- To reduce the risk of fire in the oven cavity:
 - Do not overcook food. Carefully attend appliance when paper, plastic or other combustible materials are placed inside the oven while cooking.
 - Remove wire twist-ties and metal handles from paper or plastic containers before placing them in the oven.
 - Do not use the oven for storage purposes. Do not leave paper products, cooking utensils or food in the oven when not in use.
 - If materials inside the oven ignite, keep the oven door closed, turn the oven off and disconnect the power cord, or shut off power at the fuse or circuit breaker panel. If the door is opened, the fire may spread.
- See door surface cleaning instructions in the Care and Cleaning section of this manual.
- GE does not support any servicing of this microwave oven, except as described by the Consumer Support section of this manual. Do not attempt to service the microwave oven yourself. If service is desired, then this appliance should be serviced only by qualified service personnel. Contact the nearest authorized service facility for examination, repair or adjustment.
- As with any appliance, close supervision is necessary when used by children.

SAVE THESE INSTRUCTIONS

IMPORTANT SAFETY INSTRUCTIONS.

READ ALL INSTRUCTIONS BEFORE USING.

⚠️ WARNING!

ARCING

If you see arcing, press the CLEAR/OFF pad and correct the problem.

Arcing is the microwave term for sparks in the oven. Arcing is caused by:

- Metal or foil touching the side of the oven.
- Foil not molded to food (upturned edges act like antennas).
- Metal, such as twist-ties, poultry pins or gold-rimmed dishes, in the microwave.
- Recycled paper towels containing small metal pieces being used in the microwave.

FOODS

- Do not pop popcorn in your microwave oven unless in a special microwave popcorn accessory or unless you use popcorn labeled for use in microwave ovens.
- Some products such as whole eggs and sealed containers—for example, closed jars—are able to explode and should not be heated in this microwave oven. Such use of the microwave oven could result in injury.
- Do not boil eggs in a microwave oven. Pressure will build up inside egg yolk and will cause it to burst, possibly resulting in injury.
- Operating the microwave with no food inside for more than a minute or two may cause damage to the oven and could start a fire. It increases the heat around the magnetron and can shorten the life of the oven.
- Foods with unbroken outer “skin” such as potatoes, hot dogs, sausages, tomatoes, apples, chicken livers and other giblets, and egg yolks should be pierced to allow steam to escape during cooking.

SUPERHEATED WATER

Liquids, such as water, coffee or tea, are able to be overheated beyond the boiling point without appearing to be boiling. Visible bubbling or boiling when the container is removed from the microwave oven is not always present. THIS COULD RESULT IN VERY HOT LIQUIDS SUDDENLY BOILING OVER WHEN THE CONTAINER IS DISTURBED OR A SPOON OR OTHER UTENSIL IS INSERTED INTO THE LIQUID.

To reduce the risk of injury to persons:

- Do not overheat the liquid.
- Stir the liquid both before and halfway through heating it.
- Do not use straight-sided containers with narrow necks.
- After heating, allow the container to stand in the microwave oven for a short time before removing the container.
- Use extreme care when inserting a spoon or other utensil into the container.
- Avoid heating baby food in glass jars, even with the lid off. Make sure all infant food is thoroughly cooked. Stir food to distribute the heat evenly. Be careful to prevent scalding when warming formula. The container may feel cooler than the formula really is. Always test the formula before feeding the baby.
- Don't defrost frozen beverages in narrow-necked bottles (especially carbonated beverages). Even if the container is opened, pressure can build up. This can cause the container to burst, possibly resulting in injury.
- Hot foods and steam can cause burns. Be careful when opening any containers of hot food, including popcorn bags, cooking pouches and boxes. To prevent possible injury, direct steam away from hands and face.
- Do not overcook potatoes. They could dehydrate and catch fire, causing damage to your oven.
- Cook meat and poultry thoroughly—meat to at least an INTERNAL temperature of 160°F and poultry to at least an INTERNAL temperature of 180°F. Cooking to these temperatures usually protects against foodborne illness.

MICROWAVE-SAFE COOKWARE

Make sure all cookware used in your microwave oven is suitable for microwaving. Most glass casseroles, cooking dishes, measuring cups, custard cups, pottery or china dinnerware which does not have metallic trim or glaze with a metallic sheen can be used. Some cookware is labeled “suitable for microwaving.”

- If you are not sure if a dish is microwave-safe, use this test: Place in the oven both the dish you are testing and a glass measuring cup filled with 1 cup of water—set the measuring cup either in or next to the dish. Microwave 1 minute at high. If the dish heats, it should not be used for microwaving. If the dish remains cool and only the water in the cup heats, then the dish is microwave-safe.
- If you use a meat thermometer while cooking, make sure it is safe for use in microwave ovens.



IMPORTANT SAFETY INFORMATION. READ ALL INSTRUCTIONS BEFORE USING.

MICROWAVE-SAFE COOKWARE (CONT.)

- Do not use recycled paper products. Recycled paper towels, napkins and waxed paper can contain metal flecks which may cause arcing or ignite. Paper products containing nylon or nylon filaments should be avoided, as they may also ignite.
- Some styrofoam trays (like those that meat is packaged on) have a thin strip of metal embedded in the bottom. When microwaved, the metal can burn the floor of the oven or ignite a paper towel.
- Do not use the microwave to dry newspapers.
- Not all plastic wrap is suitable for use in microwave ovens. Check the package for proper use.
- Paper towels, waxed paper and plastic wrap can be used to cover dishes in order to retain moisture and prevent spattering. Be sure to vent plastic wrap so steam can escape.
- Cookware may become hot because of heat transferred from the heated food. Pot holders may be needed to handle the cookware.
- “Boilable” cooking pouches and tightly closed plastic bags should be slit, pierced or vented as directed by package. If they are not, plastic could burst during or immediately after cooking, possibly resulting in injury. Also, plastic storage containers should be at least partially uncovered because they form a tight seal. When cooking with containers tightly covered with plastic wrap, remove covering carefully and direct steam away from hands and face.
- Use foil only as directed in this manual. TV dinners may be microwaved in foil trays less than 3/4” high; remove the top foil cover and return the tray to the box. When using foil in the microwave oven, keep the foil at least 1” away from the sides of the oven.
- Plastic cookware—Plastic cookware designed for microwave cooking is very useful, but should be used carefully. Even microwave-safe plastic may not be as tolerant of overcooking conditions as are glass or ceramic materials, and may soften or char if subjected to short periods of overcooking. In longer exposures to overcooking, the food and cookware could ignite.

Follow these guidelines:

- 1 Use microwave-safe plastics only and use them in strict compliance with the cookware manufacturer’s recommendations.
- 2 Do not microwave empty containers.
- 3 Do not permit children to use plastic cookware without complete supervision.

GROUNDING INSTRUCTIONS

⚠ WARNING!

Improper use of the grounding plug can result in a risk of electric shock.

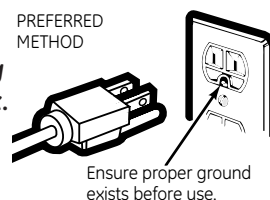

This appliance must be grounded. In the event of an electrical short circuit, grounding reduces the risk of electric shock by providing an escape wire for the electric current. This appliance is equipped with a power cord having a grounding wire with a grounding plug. The plug must be plugged into an outlet that is properly installed and grounded.

Consult a qualified electrician if the grounding instructions are not completely understood, or if doubt exists as to whether the appliance is properly grounded.

If the outlet is a standard 2-prong wall outlet, it is your personal responsibility and obligation to have it replaced with a properly grounded 3-prong wall outlet.

Do not under any circumstances cut or remove the third (ground) prong from the power cord.

For best operation, plug this appliance into its own electrical outlet to prevent flickering of lights, blowing of fuse or tripping of circuit breaker.

We do not recommend using an extension cord with this appliance. If the power cord is too short, have a qualified electrician install an outlet near the appliance. (See Extension Cords section below.)

EXTENSION CORDS

A short power supply cord is provided to reduce the risks resulting from becoming entangled in or tripping over a longer cord.

Extension cords may be used if you are careful in using them.

If an extension cord is used—

- 1 The marked electrical rating of the extension cord should be at least as great as the electrical rating of the appliance;
- 2 The extension cord must be a grounding-type 3-wire cord and it must be plugged into a 3-slot outlet;
- 3 The extension cord should be arranged so that it will not drape over the countertop or tabletop where it can be pulled on by children or tripped over unintentionally.

If you use an extension cord, the interior light may flicker and the blower sound may vary when the microwave oven is on. Cooking times may be longer, too.

READ AND FOLLOW THIS SAFETY INFORMATION CAREFULLY.

SAVE THESE INSTRUCTIONS

Features

(Throughout this manual, features and appearance may vary from your model.)

1. Door Latches.

2. Window with Metal Shield. Screen allows cooking to be viewed while keeping microwaves confined in the oven.

3. Convenience Guide.

NOTE: Rating plate, oven vent(s) and oven light are located on the inside walls of the microwave oven.

4. Touch Control Panel Display.

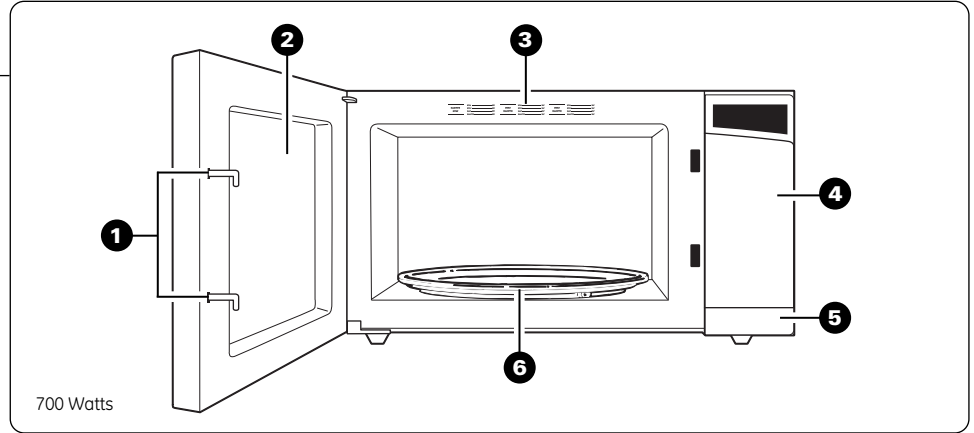

5. Door Latch Release. Press latch release to open the door.

6. Removable Turntable. Turntable and support **must** be in place when using the oven. The turntable may be removed for cleaning.

Quick Start

(Throughout this manual, features and appearance may vary from your model.)

The Controls on Your Microwave Oven

You can microwave by **time** or with the **convenience** features.

Time Features

Press	Enter
Time Cook	Amount of cooking time.
Time Defrost (Amount of defrosting time)	Amount of defrosting time.
Add 30	Starts automatically!
Power Level	Power level 1-9 (automatically set at Hi).

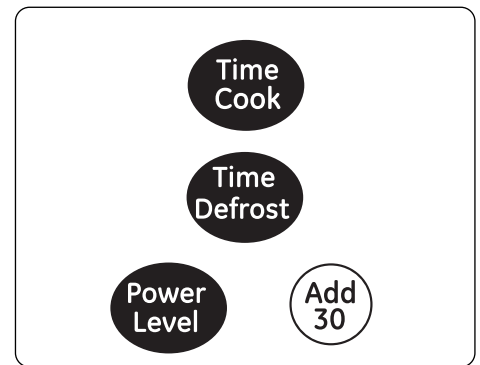

Convenience Features

Press	Enter
Popcorn	3.5 oz. or 3.0 oz. package
Beverage	1-4 servings
Pizza	1-4 slices
Dinner plate	1 or 2 servings
Cook	Food type 1-6

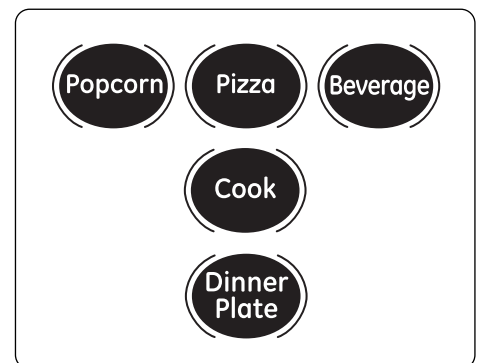

Changing Power Levels

Variable power levels add flexibility to microwave cooking. The power levels on the microwave oven can be compared to the surface units on a range. Power level Hi or full power is the fastest way to cook and gives you 100% power. Each power level gives you microwave energy a certain percent of the time. Power level 7 is microwave energy 70% of the time. Power level 3 is energy 30% of the time.

A high setting will cook faster but food may need more frequent stirring, rotating or turning over. Most cooking will be done on power level Hi. A lower setting will cook more evenly and need less stirring or rotating of the food.

Some foods may have better flavor, texture or appearance if one of the lower settings is used. Use a lower power level when cooking foods that have a tendency to boil over, such as scalloped potatoes.

Rest periods (when the microwave energy cycles off) give time for the food to “equalize” or transfer heat to the inside of the food. An example of this is shown with power level 3—the defrost cycle. If microwave energy did not cycle off, the outside of the food would cook before the inside was defrosted.

Here are some examples of uses for various power levels:

Power Level	Best Uses
Hi	Fish, bacon, vegetables, boiling liquids.
Med-High 7	Gentle cooking of meat and poultry; baking casseroles and reheating.
Medium 5	Slow cooking and tenderizing such as stews and less tender cuts of meat.
Low 2 or 3	Defrosting without cooking; simmering; delicate sauces.
Warm 1	Keeping food warm without overcooking; softening butter.

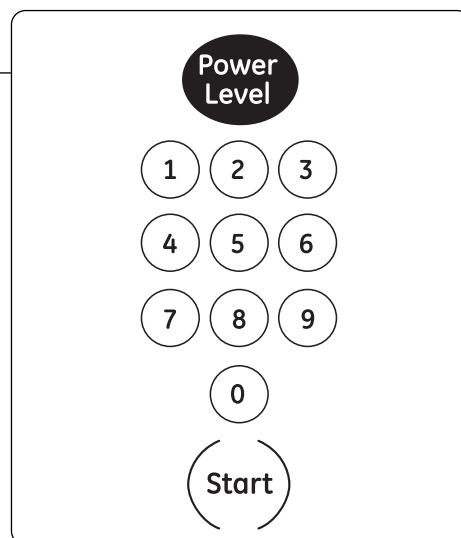

How to Change the Power Level

The power level may be entered or changed immediately after entering the feature time for Time Cook.

1. Press **Time Cook**.
2. Enter cooking time.
3. Press **Power Level**.
4. Select desired power level 1–9.
5. Press **Start**.

Time Features

Time Cook

The power level may be changed if you do not want full power.

1. Press **Time Cook**.
2. Enter cooking time.
3. Change power level if you don't want full power. (Press **Power Level**. Select a desired power level 1–9.)
4. Press **Start**.

Time Cook

Allows you to microwave for any time up to 99 minutes and 99 seconds.

Power level Hi is automatically set, but you may change it for more flexibility.

You may open the door during Time Cook to check the food. Close the door and press Start to resume cooking.

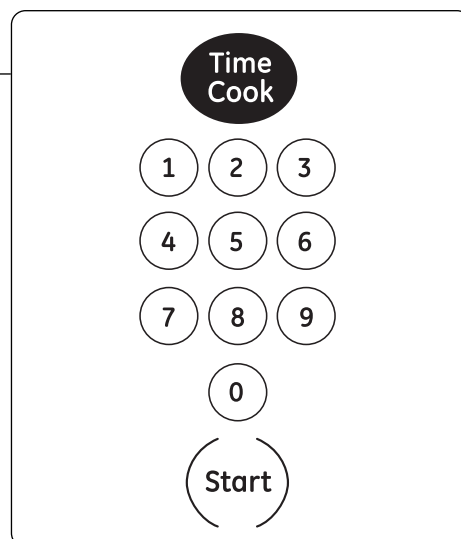

Time Features (cont)

Time Cook Guide – NOTE: Use power level Hi unless otherwise noted.

Vegetable	Amount	Time	Comments
Asparagus (fresh spears) (frozen spears)	1 lb. 10-oz. package	7 to 10 min., Med-High (7) 5 to 8 min.	In 1½-qt. casserole, place 1/4 cup water. In 1-qt. casserole.
Beans (fresh green) (frozen green) (frozen lima)	1 lb. cut in half 10-oz. package 10-oz. package	12 to 17 min. 6 to 9 min. 6 to 9 min.	In 1½-qt. casserole, place 1/2 cup water. In 1-qt. casserole, place 2 tablespoons water. In 1-qt. casserole, place 1/4 cup water.
Beets (fresh, whole)	1 bunch	18 to 25 min.	In 2-qt. casserole, place 1/2 cup water.
Broccoli (fresh cut) (fresh spears) (frozen, chopped) (frozen spears)	1 bunch (1¼ to 1½ lbs.) 1 bunch (1¼ to 1½ lbs.) 10-oz. package 10-oz. package	7 to 10 min. 9 to 13 min. 5 to 8 min. 5 to 8 min.	In 2-qt. casserole, place 1/2 cup water. In 2-qt. casserole, place 1/4 cup water. In 1-qt. casserole. In 1-qt. casserole, place 3 tablespoons water.
Cabbage (fresh) (wedges)	1 medium head (about 2 lbs.)	8 to 13 min. 7 to 14 min.	In 1½- or 2-qt. casserole, place 1/4 cup water. In 2- or 3-qt. casserole, place 1/4 cup water.
Carrots (fresh, sliced) (frozen)	1 lb. 10-oz. package	6 to 9 min. 5 to 8 min.	In 1½-qt. casserole, place 1/4 cup water. In 1-qt. casserole, place 2 tablespoons water.
Cauliflower (flowerets) (fresh, whole) (frozen)	1 medium head 1 medium head 10-oz. package	9 to 14 min. 9 to 17 min. 5 to 8 min.	In 2-qt. casserole, place 1/2 cup water. In 2-qt. casserole, place 1/2 cup water. In 1-qt. casserole, place 2 tablespoons water.
Corn (frozen kernel)	10-oz. package	4 to 8 min.	In 1-qt. casserole, place 2 tablespoons water.
Corn on the cob (fresh) (frozen)	1 to 5 ears 1 ear 2 to 6 ears	3 to 5 min. per ear 5 to 7 min. 2 to 4 min. per ear	In 2-qt. glass baking dish, place corn. If corn is in husk, use no water; if corn has been husked, add 1/4 cup water. Rearrange after half of time. Place in 2-qt. glass baking dish. Cover with vented plastic wrap. Rearrange after half of time.
Mixed vegetables (frozen)	10-oz. package	4 to 8 min.	In 1-qt. casserole, place 3 tablespoons water.
Peas (fresh, shelled) (frozen)	2 lbs. unshelled 10-oz. package	9 to 12 min. 4 to 8 min.	In 1-qt. casserole, place 1/4 cup water. In 1-qt. casserole, place 2 tablespoons water.
Potatoes (fresh, cubed, white) (fresh, whole, sweet or white)	4 potatoes (6 to 8 oz. each) 1 (6 to 8 oz.)	11 to 14 min. 2 to 5 min.	Peel and cut into 1 inch cubes. Place in 2-qt. casserole with 1/2 cup water. Stir after half of time. Pierce with cooking fork. Place in center of the oven. Let stand 5 minutes.
Spinach (fresh) (frozen, chopped and leaf)	10 to 16 oz. 10-oz. package	5 to 8 min. 5 to 8 min.	In 2-qt. casserole, place washed spinach. In 1-qt. casserole, place 3 tablespoons water.
Squash (fresh, summer and yellow) (winter, acorn or butternut)	1 lb. sliced 1 to 2 squash (about 1 lb. each)	4 to 7 min. 7 to 11 min.	In 1½-qt. casserole, place 1/4 cup water. Cut in half and remove fibrous membranes. In 2-qt. glass baking dish, place squash cut-side-down. Turn cut-side-up after 4 minutes.

Time Features (cont)

Time Defrost

Allows you to defrost for a selected length of time. See the Defrosting Guide for suggested times.

1. Press **Time Defrost**.
2. Enter defrosting time.
3. Press **Start**.
4. Turn the food over after half the time.
5. Press **Start**.

At one half of selected defrosting time, turn food over and break apart or rearrange pieces for more even defrosting. Shield any warm areas with small pieces of foil. The oven will continue to defrost if you don't open the door and turn the food.

A dull thumping noise may be heard during defrosting. This is normal when oven is not operating at Hi power.

Defrosting Tips

- Foods frozen in paper or plastic can be defrosted in the package. Closed packages should be slit, pierced or vented AFTER food has partially defrosted. Plastic storage containers should be partially uncovered.
- Family-size, prepackaged frozen dinners can be defrosted and microwaved. If the food is in a foil container, transfer it to a microwave-safe dish.
- Foods that spoil easily should not be allowed to sit out for more than one hour after defrosting. Room temperature promotes the growth of harmful bacteria.
- When defrosted, food should be cool but softened in all areas. If still slightly icy, return to the microwave very briefly, or let it stand a few minutes.

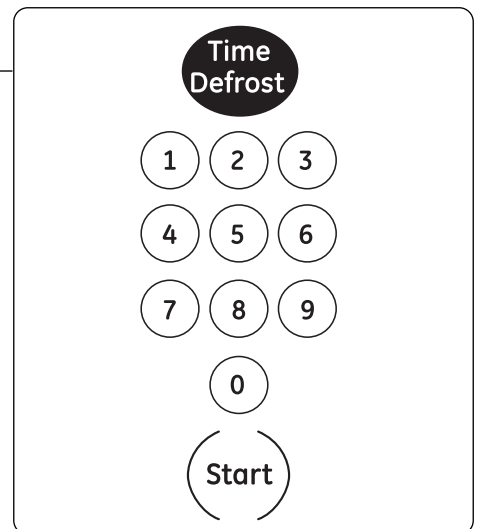

Defrosting Guide

Food	Time	Comments
Breads, Cakes Bread, buns or rolls (1 piece) Sweet rolls (approx. 12 oz.)	1/2 min. 3 to 5 min.	Rearrange after half the time.
Fish and Seafood Fillets, frozen (1 lb.) Shellfish, small pieces (1 lb.)	6 to 9 min. 6 to 9 min.	Place block in casserole. Turn over and break up after half the time.
Fruit Plastic pouch—1 or 2 (10-oz. package)	2 to 6 min.	
Meat Bacon (1 lb.) Franks (1 lb.) Ground meat (1 lb.) Roast: beef, lamb, veal, pork Steaks, chops and cutlets	4 to 7 min. 4 to 7 min. 10 to 12 min. 9 to 13 min. per lb. 9 to 13 min. per lb.	Place unopened package in oven. Let stand 5 minutes after defrosting. Place unopened package in oven. Microwave just until franks can be separated. Let stand 5 minutes, if necessary, to complete defrosting. Turn meat over after first half of time. Use power level 1 . Place unwrapped meat in cooking dish. Turn over after first half of time and shield warm areas with foil. After second half of time, separate pieces with table knife. Let stand to complete defrosting.
Poultry Chicken, broiler-fryer, cut up (2½ to 3 lbs.) Chicken, whole (2½ to 3 lbs.) Cornish hen Turkey breast (4 to 6 lbs.)	26 to 32 min. 26 to 32 min. 7 to 13 min. per lb. 9 to 14 min. per lb.	Place wrapped chicken in dish. Unwrap and turn over after first half of time. After second half of time, separate pieces and place in cooking dish. Microwave 2 to 4 minutes more, if necessary. Let stand a few minutes to finish defrosting. Place wrapped chicken in dish. After half the time, unwrap and turn chicken over. Shield warm areas with foil. To complete defrosting, run cold water in the cavity until giblets can be removed. Place unwrapped hen in the oven breast-side-up. Turn over after first half of time. Run cool water in the cavity until giblets can be removed. Place unwrapped breast in microwave-safe dish breast-side-down. After first half of time, turn breast-side-up and shield warm areas with foil. Defrost for second half of time. Let stand 1 to 2 hours in refrigerator to complete defrosting.

Time Features (cont)

Add 30

It will add 30 seconds to the time counting down each time the pad is pressed.

Each touch will add 30 seconds, up to 99 minutes and 99 seconds.

The oven will start immediately when pressed.



Convenience Features

Popcorn

How to Use the Popcorn Feature

1. Follow package instructions. Place the package of popcorn in the center of the microwave.

2. Press **Popcorn** once for a 3.5 ounce package of popcorn and twice for a 3.0 ounce package. The oven will start immediately after **Popcorn** is touched.



Use only with prepackaged microwave popcorn weighing 3.0 to 3.5 ounces.

Beverage

The Beverage feature works best for heating a beverage that is at room temperature.

Press **Beverage** once for 8 oz., twice for 12 oz., three times for 16 oz. and four times for 4 oz. The oven will start immediately when **Beverage** is touched.

Beverages heated with the Beverage feature may be very hot. Remove the container with care.



Cook

The Cook feature automatically sets the cooking times and power levels for a variety of foods.

1. Press **Cook**. Code will be displayed.
2. Select food type 1-6. Serving Sizes 1-4 will be displayed.
3. Enter Serving Size 1-4.
4. The oven starts automatically.

Food Code	Food	Serving Size
1	Baked potato	1-4
2	Canned veg.	1-4
3	Fresh veg.	1-4
4	Frozen veg.	1-4
5	Chicken	1-4
6	Fish	1-4

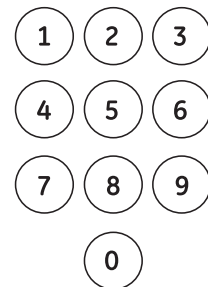

Dinner Plate

The Dinner Plate feature reheats previously cooked foods.

Press **Dinner Plate** once to reheat. A cooking time of 6:00 starts counting down.

The oven starts immediately after **Dinner Plate** is touched.

Be sure to cover the plate with plastic wrap.



Convenience Features (cont)

Pizza

The Pizza feature is for reheating 1 to 4 slices of pizza.

Press **Pizza** once for one slice of pizza, twice for two slices, three times for three slices and four times for four slices. The oven will start immediately after **Pizza** is touched.



Other Features

Clock

Press **Clock** to enter the time of day.

1. Press **Clock**.
2. Enter time of day.
3. Press **Start** or **Clock**.

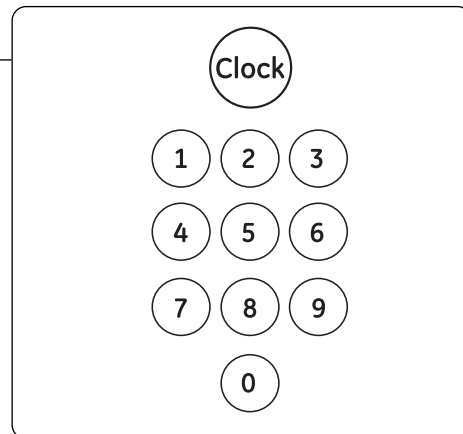

Timer

The Timer operates as a minute timer.

1. Press **Timer**.
2. Enter amount of time you want to count down.
3. Press **Timer**. When the time is up, the timer will signal.

The Timer feature operates without microwave energy.

To stop the timer, press and hold **Timer** for 3 seconds.

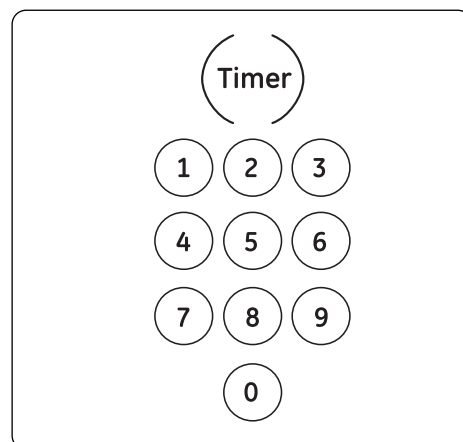

Clear/Off

To pause cooking, press **Start**. To continue cooking, press **Start** again. Clear/Off will not stop the Timer.

Press once to stop and erase your cooking settings.

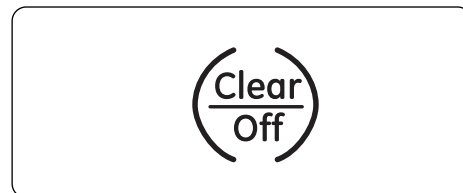

Child Lock-Out

You may lock the control panel to prevent the microwave from being accidentally started or used by children.

To lock or unlock the controls, press and hold **Clear/Off** for about three seconds. When the control panel is locked, Loc or UnLo appears in the display.



Microwave Terms

Term	Definition
Arcing	Arcing is the microwave term for sparks in the oven. Arcing is caused by: <ul style="list-style-type: none"> • metal or foil touching the side of the oven. • foil that is not molded to food (upturned edges act like antennas). • metal such as twist-ties, poultry pins, gold-rimmed dishes. • recycled paper towels containing small metal pieces.
Covering	Covers hold in moisture, allow for more even heating and reduce cooking time. Venting plastic wrap or covering with wax paper allows excess steam to escape.
Shielding	In a regular oven, you shield chicken breasts or baked foods to prevent over-browning. When microwaving, you use small strips of foil to shield thin parts, such as the tips of wings and legs on poultry, which would cook before larger parts.
Standing Time	When you cook with regular ovens, foods such as roasts or cakes are allowed to stand to finish cooking or to set. Standing time is especially important in microwave cooking. Note that a microwaved cake is not placed on a cooling rack.
Venting	After covering a dish with plastic wrap, you vent the plastic wrap by turning back one corner so excess steam can escape.

Care and Cleaning

Helpful Hints

An occasional thorough wiping with a solution of baking soda and water keeps the inside fresh.

UNPLUG THE CORD BEFORE CLEANING ANY PART OF THIS OVEN.



How to Clean the Inside

Walls, Floor, Inside Window, Metal and Plastic Parts on the Door

Some spatters can be removed with a paper towel; others may require a damp cloth. Remove greasy spatters with a sudsy cloth, then rinse with a damp cloth. Do not use abrasive cleaners or sharp utensils on oven walls. To clean the surface of the door and the surface of the oven that come together upon closing, use only mild, nonabrasive soaps or detergents using a sponge or soft cloth. Rinse with a damp cloth and dry.

Never use a commercial oven cleaner on any part of your microwave.

Removable Turntable and Turntable Support

To prevent breakage, do not place the turntable into water just after cooking. Wash it carefully in warm, sudsy water or in the dishwasher. The turntable and support can be broken if dropped. Remember, do not operate the oven without the turntable and support in place.

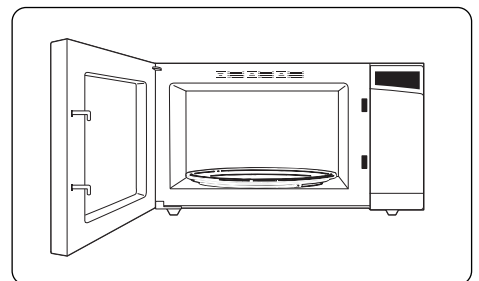

Care and Cleaning (cont)

How to Clean the Outside

Case

Clean the outside of the microwave with a sudsy cloth. Rinse and then dry. Wipe the window clean with a damp cloth.

Control Panel and Door

Wipe with a damp cloth. Dry thoroughly. Do not use cleaning sprays, large amounts of soap and water, abrasives or sharp objects on the panel—they can damage it. Some paper towels can also scratch the control panel.

Door Surface

It's important to keep the area clean where the door seals against the microwave. Use only mild, non-abrasive detergents applied with a clean sponge or soft cloth. Rinse well.

Power Cord

If the cord becomes soiled, unplug and wash with a damp cloth. For stubborn spots, sudsy water may be used, but be certain to rinse with a damp cloth and dry thoroughly before plugging cord into outlet.

Do not use cleaners containing ammonia or alcohol on the microwave oven. Ammonia or alcohol can damage the appearance of the microwave.

If Something Goes Wrong

Problem	Possible Causes	What To Do
Oven will not start	A fuse in your home may be blown or the circuit breaker tripped.	• Replace fuse or reset circuit breaker.
	Power surge.	• Unplug the microwave oven, then plug it back in.
	Plug not fully inserted into wall outlet.	• Make sure the 3-prong plug on oven is fully inserted into wall outlet.
Control panel lighted, yet oven will not start.	Door not securely closed.	• Open the door and close securely.
	Start not pressed after entering cooking selection.	• Press Start.
	Another selection entered already in oven and Clear/Off not pressed to cancel it.	• Press Clear/Off.
	Cooking time not entered after pressing Time Cook.	• Make sure you have entered cooking time after pressing Time Cook.
	Start was pressed accidentally.	• Reset cooking program and press Start.

Things That Are Normal

- Steam or vapor escaping from around the door.
- Light reflection around door or outer case.
- Dimming oven light and change in the blower sound at power levels other than high.
- Dull thumping sound while oven is operating.
- TV-radio interference might be noticed while using the microwave. Similar to the interference caused by other small appliances, it does not indicate a problem with the microwave. Plug the microwave into a different electrical circuit, move the radio or TV as far away from the microwave as possible, or check the position and signal of the TV/radio antenna.

GE Microwave Oven Warranty

Staple your receipt here.
Proof of the original purchase
date is needed to make a
warranty claim.

For The Period Of:	What GE Will Provide:
One Year <i>From the date of the original purchase</i>	Replacement unit for any product which fails due to a defect in materials or workmanship. The exchange unit is warranted for the remainder of your product's original one-year warranty period.

In Order to Make a Warranty Claim:

- Properly pack your unit. We recommend using the original carton and packing materials.
- Return the product to the retail location where it was purchased.
- Include in the package a copy of the sales receipt or other evidence of date of original purchase. Also print your name and address and a description of the defect.

What GE Will Not Cover:

- Customer instructions. This owner's manual provides information regarding operating instructions and user controls.
- Improper installation, delivery or maintenance.
- Failure of the product or damage to the product if it is abused, misused (for example, cavity arcing from wire rack or metal/foil), or used for other than the intended purpose or used commercially.
- Replacement of house fuses or resetting of circuit breakers.
- Damage to the product caused by accident, fire, floods or acts of God.
- Incidental or consequential damage caused by possible defects with this appliance.
- Damage caused after delivery.

EXCLUSION OF IMPLIED WARRANTIES—Your sole and exclusive remedy is product exchange as provided in this Limited Warranty. Any implied warranties, including the implied warranties of merchantability or fitness for a particular purpose, are limited to one year or the shortest period allowed by law.

This warranty is extended to the original purchaser and any succeeding owner for products purchased for home use within the USA.

Some states do not allow the exclusion or limitation of incidental or consequential damages. This warranty gives you specific legal rights, and you may also have other rights which vary from state to state. To know what your legal rights are, consult your local or state consumer affairs office or your state's Attorney General.

Exclusion of implied warranties: Except where prohibited or restricted by law, there are no warranties, whether express, oral or statutory which extend beyond the description on the face hereof, including specifically the implied warranties of merchantability or fitness for a particular purpose.

Warrantor: General Electric Company, Louisville, KY 40225

Consumer Support

GE Appliances Website

ge.com

Have a question or need assistance with your appliance? Try the GE Appliances Website 24 hours a day, any day of the year! For greater convenience and faster service, you can now download Owner's Manuals, or even order parts on-line.

Real Life Design Studio

ge.com

GE supports the Universal Design concept—products, services and environments that can be used by people of all ages, sizes and capabilities. We recognize the need to design for a wide range of physical and mental abilities and impairments. For details of GE's Universal Design applications, including kitchen design ideas for people with disabilities, check out our Website today. For the hearing impaired, please call 800.TDD.GEAC (800.833.4322).

Parts and Accessories

ge.com

A replacement turntable (WB49X688) or turntable support ring (WB06X10696) is available at extra cost from our Parts Center and can be sent directly to your home (VISA, MasterCard and Discover cards are accepted). Order on-line today, 24 hours every day or by phone at 800.626.2002 during normal business hours.

Instructions contained in this manual cover procedures to be performed by any user. GE does not support any servicing of the microwave oven. We strongly recommend that you do not attempt to service the microwave oven yourself.

Contact Us

ge.com

If you are not satisfied with the service you receive from GE, contact us on our Website with all the details including your phone number, or write to:

General Manager, Customer Relations
GE Appliances, Appliance Park
Louisville, KY 40225



GE Consumer & Industrial
Appliances
General Electric Company
Louisville, KY 40225
ge.com

Printed in China

Free Manuals Download Website

<http://myh66.com>

<http://usermanuals.us>

<http://www.somanuals.com>

<http://www.4manuals.cc>

<http://www.manual-lib.com>

<http://www.404manual.com>

<http://www.luxmanual.com>

<http://aubethermostatmanual.com>

Golf course search by state

<http://golfingnear.com>

Email search by domain

<http://emailbydomain.com>

Auto manuals search

<http://auto.somanuals.com>

TV manuals search

<http://tv.somanuals.com>