



Use and Care & Cooking Guide

Turntable Microwave Oven



Safety Instructions	3-5
Precautions to Avoid Possible Exposure to Excessive Microwave Energy	2



Operating Instructions, Tips	
Add 30 Seconds	16
Aluminum Foil	4, 11, 20
Auto Defrost	10, 11
Clock	9
Control Panel.....	8, 9
Cook.....	15, 16
Cooking Complete Reminder	7
Cooking Guide	21
Defrosting Guide	20
Delay Start	17
Delayed Cooking.....	17
Features	7
Glossary of Microwave Terms	18
Heating or Reheating Guide.....	19
Hold Time.....	17
Instant Cook	16
Microwaving Tips	6
Kitchen Timer.....	17
Popcorn	15
Power Levels	6, 12, 13, 17
Program Cooking.....	7
Reheat.....	14
Time Cook.....	13
Time Defrost.....	12
Turntable	3, 4, 7



Problem Solver	24
More questions?...call <i>GE Answer Center® 800.626.2000</i>	



Care and Cleaning	22
Control Panel	22
Turntable.....	22



Installation	23
Adapter Plugs	23
Extension Cords	23
Grounding Instructions.....	23



Consumer Services	27
Appliance Registration.....	2
Important Phone Numbers.....	27
Model and Serial Number Location.....	2
Warranty	Back Cover

Model: JES1143

Microwave power output of this oven is 900 watts.
(IEC-705 Test Procedure)



HELP US HELP YOU...

Before using your oven, read this guide carefully.

It is intended to help you operate and maintain your new microwave oven properly.

Keep it handy for answers to your questions.

If you don't understand something or need more help, call:

GE Answer Center®

800.626.2000

24 hours a day, 7 days a week

Write down the model and serial numbers.

You'll find them on a label inside the oven.

These numbers are also on the Consumer Product Ownership Registration Card that came with your microwave oven. Before sending in this card, please write these numbers here:

Model Number

Serial Number

Use these numbers in any correspondence or service calls concerning your microwave oven.

If you received a damaged oven...

Immediately contact the dealer (or builder) that sold you the oven.

Save time and money. Before you request service...

Check the Problem Solver in the back of this guide. It lists causes of minor operating problems that you can correct yourself.

All these things are normal with your microwave oven.

- Steam or vapor escaping from around the door.
- Light reflection around door or outer case.
- Dimming oven light and change in blower sound may occur while operating at power levels other than high.
- Dull thumping sound while oven is operating.
- Some TV-radio interference might be noticed while using your microwave oven. It's similar to the interference caused by other small appliances and does not indicate a problem with your microwave. If you notice this interference, check that the microwave oven is on a different electrical circuit, relocate the radio or TV as far away from the microwave as possible, or check the position and signal of the receiving antenna.

PRECAUTIONS TO AVOID POSSIBLE EXPOSURE TO EXCESSIVE MICROWAVE ENERGY

- Do Not Attempt** to operate this oven with the door open since open-door operation can result in harmful exposure to microwave energy. It is important not to defeat or tamper with the safety interlocks.
- Do Not Place** any object between the oven front face and the door or allow soil or cleaner residue to accumulate on sealing surfaces.
- Do Not Operate** the oven if it is damaged. It is particularly important that the oven door close properly and that there is no damage to the:
 - (1) door (bent)
 - (2) hinges and latches (broken or loosened)
 - (3) door seals and sealing surfaces.
- The Oven Should Not** be adjusted or repaired by anyone except properly qualified service personnel.

IMPORTANT SAFETY INSTRUCTIONS

Read all instructions before using this appliance.



When using electrical appliances, basic safety precautions should be followed, including the following:

⚠ WARNING—To reduce the risk of burns, electric shock, fire, injury to persons or exposure to excessive microwave energy:

- **Read and follow** the specific “Precautions to Avoid Possible Exposure to Excessive Microwave Energy” on the previous page.
 - **This appliance must be grounded.** Connect only to properly grounded outlet. See Grounding Instructions section in the back of this guide.
 - **Use this appliance only for its intended use as described in this guide.** Do not use corrosive chemicals or vapors in this appliance. This microwave oven is specifically designed to heat or cook food, and is not intended for laboratory or industrial use.
 - **For best operation, plug this appliance into its own electrical outlet, to prevent flickering of lights, blowing of fuse or tripping of circuit breaker.**
 - **Install or locate this appliance only in accordance with the provided Installation Instructions.**
 - **Be certain to place the front surface of the door three inches or more back from the countertop edge to avoid accidental tipping of the appliance in normal usage.**
 - **Do not cover or block any openings on the appliance.**
 - **Do not store this appliance outdoors.** Do not use this product near water—for example, in a wet basement, near a swimming pool or near a sink.
 - **This microwave oven is not approved or tested for marine use.**
 - **Do not immerse power cord or plug in water.**
 - **Keep power cord away from heated surfaces.**
 - **Do not operate any heating or cooking appliance beneath this microwave oven.**
 - **Do not mount the microwave oven over or near any portion of a heating cooking appliance.**
 - **Do not store anything directly on top of the microwave oven surface when the microwave oven is in operation.**
 - **Do not let power cord hang over edge of table or counter.**
 - **Do not operate this appliance if it has a damaged power cord or plug, if it is not working properly or if it has been damaged or dropped.**
 - **Do not operate oven without the turntable and turntable support seated and in place.**
 - **Do not allow turntable to be restricted so the turntable cannot rotate.**
 - **See door surface cleaning instructions** in the Care and Cleaning section(s) of this guide.
 - **This appliance should be serviced only by qualified service personnel.** Contact nearest authorized service facility for examination, repair or adjustment.
 - **As with any appliance, close supervision is necessary when used by children.**
-
- **To reduce the risk of fire in the oven cavity:**
 - Do not overcook food.** Carefully attend appliance if paper, plastic or other combustible materials are placed inside the oven to facilitate cooking.
 - Remove wire twist-ties and metal handles** from paper or plastic containers before placing them in the oven.
 - Do not use your microwave oven to dry newspapers.**
 - Do not use recycled paper products.** Recycled paper towels, napkins and waxed paper can contain metal flecks which may cause arcing or ignite. Paper products containing nylon or nylon filaments should be avoided, as they may also ignite. Some styrofoam trays (like those that meat is packaged on) have a thin strip of metal embedded in the bottom. When microwaved, the metal can burn the floor of the oven or ignite a paper towel.
 - Do not overcook potatoes.** They could dehydrate and catch fire, causing damage to your oven.

(continued next page)



IMPORTANT SAFETY INSTRUCTIONS

(continued)

- Do not pop popcorn in your microwave oven unless it is in a special microwave popcorn accessory or unless you use popcorn labeled for use in microwave ovens.
- Do not operate the oven while empty to avoid damage to the oven and the danger of fire. If by accident the oven should run empty a minute or two, no harm is done. However, try to avoid operating the oven empty at all times—it saves energy and prolongs the life of the oven.
- Do not use the oven for storage purposes. Do not leave paper products, cooking utensils or food in the oven when not in use.
- If materials inside oven should ignite, keep oven door closed, turn oven off and disconnect power cord, or shut off power at the fuse or circuit breaker panel. If the door is opened, the fire may spread.

- **Some products such as whole eggs and sealed containers**—for example, closed jars—will explode and should not be heated in this microwave oven. Such use of the microwave oven could result in injury.
- **Avoid heating baby food** in glass jars, even with the lid off. Make sure all infant food is thoroughly cooked. Stir food to distribute heat evenly. Be careful to prevent scalding when warming formula or breast milk. The container may feel cooler than the milk really is. Always test the milk before feeding the baby.
- **Do not defrost frozen beverages in narrow-necked bottles** (especially carbonated beverages). Even if the container is opened, pressure can build up. This can cause the container to burst, possibly resulting in injury.
- **Use foil only as directed in this guide.** TV dinners may be microwaved in foil trays less than 3/4" high; remove the top foil cover and return the tray to the box. When using foil in the microwave oven, keep the foil at least 1 inch away from the sides of the oven.



- **Cookware may become hot because of heat transferred from the heated food.** Pot holders may be needed to handle the cookware.

- **Sometimes, the turntable can become too hot to touch.** Be careful touching the turntable during and after cooking.
- **Foods cooked in liquids** (such as pasta) may tend to boil over more rapidly than foods containing less moisture. Should this occur, refer to the Care and Cleaning section(s) for instructions on how to clean the inside of the oven.
- **Thermometer**—Do not use a thermometer in food you are microwaving unless the thermometer is designed or recommended for use in the microwave oven.
- **Plastic cookware**—Plastic cookware designed for microwave cooking is very useful, but should be used carefully. Even microwave-safe plastic may not be as tolerant of overcooking conditions as are glass or ceramic materials and may soften or char if subjected to short periods of overcooking. In longer exposures to overcooking, the food and cookware could ignite. For these reasons:
 - 1) Use microwave-safe plastics only and use them in strict compliance with the cookware manufacturer's recommendations.
 - 2) Do not subject empty cookware to microwaving.
 - 3) Do not permit children to use plastic cookware without complete supervision.

- **When cooking pork**, follow the directions exactly and always cook the meat to an internal temperature of at least 170°F. This assures that, in the remote possibility that trichina may be present in the meat, it will be killed and meat will be safe to eat.
- **Do not boil eggs in a microwave oven.** Pressure will build up inside egg yolk and will cause it to burst, possibly resulting in injury.



- **Foods with unbroken outer "skin"** such as potatoes, sausages, tomatoes, apples, chicken livers and other giblets and egg yolks (see previous caution) should be pierced to allow steam to escape during cooking.



SAFETY FACT—Superheated water.

Microwaved water and other liquids do not always bubble when they reach the boiling point. They can actually get superheated and not bubble at all.

Superheated liquid will bubble up out of the cup when it is moved or when something like a spoon or tea bag is put into it.

To prevent this from happening and causing injury, do not heat any liquid for more than 2 minutes per cup. After heating, let the cup stand in the microwave for 30 seconds before moving it or putting anything into it.

- **Spontaneous boiling**—Under certain special circumstances, liquids may start to boil during or shortly after removal from the microwave oven. To prevent burns from splashing liquid, we recommend the following: before removing the container from the oven, allow it to stand in the oven for 30 to 40 seconds after the oven has shut off. **Do not boil liquids in narrow-necked containers such as soft drink bottles, wine flasks and especially narrow-necked coffee cups.** Even if the container is opened, excessive steam can build up and cause it to burst or overflow.

- **Not all plastic wrap is suitable for use in microwave ovens.** Check the package for proper use.
- **“Boilable” cooking pouches and tightly closed plastic bags** should be slit, pierced or vented as directed by package. If they are not, plastic could burst during or immediately after cooking, possibly resulting in injury. Also, plastic storage containers should be at least partially uncovered because they form a tight seal. When cooking with containers tightly covered with plastic wrap, remove covering carefully and direct steam away from hands and face.



- **Hot foods and steam can cause burns.** Be careful when opening any containers of hot food, including popcorn bags, cooking pouches and boxes. To prevent possible injury, direct steam away from hands and face.

SAVE THESE INSTRUCTIONS

IF YOU NEED SERVICE...



To obtain service, see the Consumer Services page in the back of this guide.

We're proud of our service and want you to be pleased. If for some reason you are not happy with the service you receive, here are three steps to follow for further help.

FIRST, contact the people who serviced your appliance. Explain why you are not pleased. In most cases, this will solve the problem.

NEXT, if you are still not pleased, write all the details—including your phone number—to:

Manager, Consumer Relations
GE Appliances
Appliance Park
Louisville, KY 40225

FINALLY, if your problem is still not resolved, write:

Major Appliance Consumer Action Program
20 North Wacker Drive
Chicago, IL 60606



MICROWAVING TIPS

- **Make sure all cookware used in your microwave oven is suitable for microwaving.** Most glass casseroles, cooking dishes, measuring cups, custard cups, pottery or china dinnerware which does not have metallic trim or glaze with a metallic sheen can be used. Some cookware is labeled “suitable for microwaving.”

- **If you are not sure if a dish is microwave-safe, use this test:** Place in the oven both the dish you are testing and a glass measuring cup filled with one cup water—set the measuring cup either in or next to the dish. Microwave 1 minute at high. If the dish heats, it should not be used for microwaving. If the dish remains cool and only the water in the cup heats, then the dish is microwave-safe.

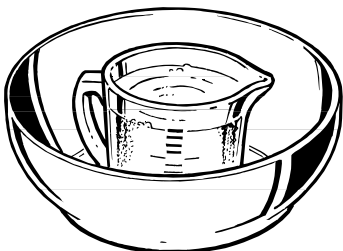

- **Paper towels, waxed paper and plastic wrap** can be used to cover dishes in order to retain moisture and prevent spattering. Be sure to vent plastic wrap so steam can escape.
- **Some microwaved foods require stirring, rotating or rearranging.** Check the Cooking Guide.
- **Steam builds up pressure in foods which are tightly covered by a skin or membrane.** Pierce potatoes, egg yolks and chicken livers to prevent bursting.

If you use a meat thermometer while cooking, make sure it is safe for use in microwave ovens.

VARIABLE POWER LEVELS (1-10)

How to Change Power Level

The power level may be entered or changed immediately after entering the feature time for TIME COOK I & II, DEFROST or INSTANT COOK. The power level may also be changed during their time countdown.

1. Press TIME COOK I & II or TIME DEFROST.
2. Select cooking or defrosting time.
3. Press POWER LEVEL.
4. Select desired power level 1-10.
5. Press START.



Variable power levels add flexibility to your microwave cooking. The power levels on your microwave oven can be compared to the surface units on a range. HIGH (Power Level 10) or full power is the fastest way to cook and gives you 100% power. Each power level gives you microwave energy a certain percent of the time. Power Level 7 is microwave energy 70% of the time. Power Level 3 is energy 30% of the time.

A high setting (10) will cook faster but may need additional attention such as frequent stirring, rotating or turning over. Most of your cooking will be done on HIGH (Power Level 10). A lower setting will cook more evenly and with less attention given to stirring or rotating the food.

Some foods may have better flavor, texture or appearance if one of the lower settings is used. You may wish to use a lower power level when cooking foods that have a tendency to boil over, such as scalloped potatoes.

Rest periods (when the microwave energy cycles off) give time for the food to “equalize” or transfer heat to the inside of the food. An example of this is shown with Power Level 3—the defrost cycle. If microwave energy did not cycle off, the outside of the food would cook before the inside was defrosted.

Here are some examples of uses for various power levels:

POWER LEVEL	BEST USES
High 10	Fish, bacon, vegetables, boiling liquids.
Med-High 7	Gentle cooking of meat and poultry; baking casseroles and reheating.
Medium 5	Slow cooking and tenderizing such as stews and less tender cuts of meat.
Low 2 or 3	Defrosting without cooking; simmering; delicate sauces.
Warm 1	Keeping food warm without overcooking; softening butter.

FEATURES OF YOUR OVEN

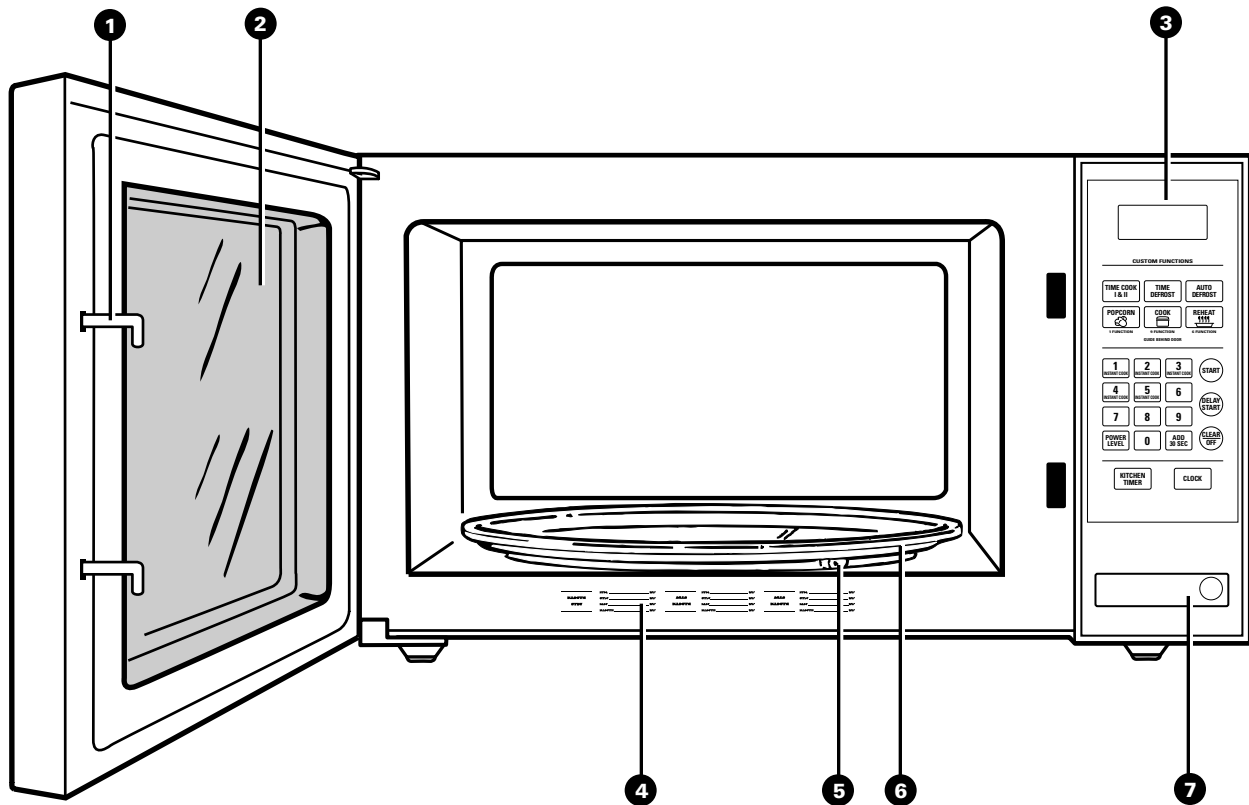

1. Door Latches.

2. Door Screen. Metal screen permits viewing of foods and keeps microwaves confined inside oven.

3. Touch Control Panel and Display. See Your Touch Control Panel section for instructions.

4. Automatic Cooking Guide. Quick reference codes for many frequently prepared foods.

5. Removable Turntable Support for Cleaning.

Turntable support must be in place when using the oven.

6. Removable Turntable for Cleaning. Turntable and support **must** be in place when using the oven. The turntable may be removed for cleaning.

7. Door Latch Release. Press latch release button to open door.

NOTE: Rating plate, oven vent(s) and oven light are located on the inside walls of the microwave oven.

Program Cooking

Use your Touch Control Panel to Time Defrost or Time Cook I & II with choice of power levels from 1 (lowest) to 10 (highest); to Reheat using a preset time and power level; to cook popcorn using a preset time and power level; to time kitchen tasks with the Kitchen Timer; and to set the clock.

Create your own programs to suit your individual cooking style. For example: use the Kitchen Timer to delay the start of Time Cook I & II or program a hold time between Time Defrost and Time Cook I & II. Set Time Cook I & II for a two-stage program using different times and power levels.

Cooking Complete Reminder

(For Time Cook and Time Defrost cycles)

To remind you that you have food in the oven, the oven will beep once a minute until you either open the oven door or touch the CLEAR/OFF pad.

When You Plug In the Oven

The display panel displays “88888,” “18 POWER” and all of the oven functions. After 15 seconds, all lights disappear and “RESET” appears in the upper portion. Touch the CLEAR/OFF pad, set the Clock and the oven is ready for use.

This will happen any time there is a power outage.

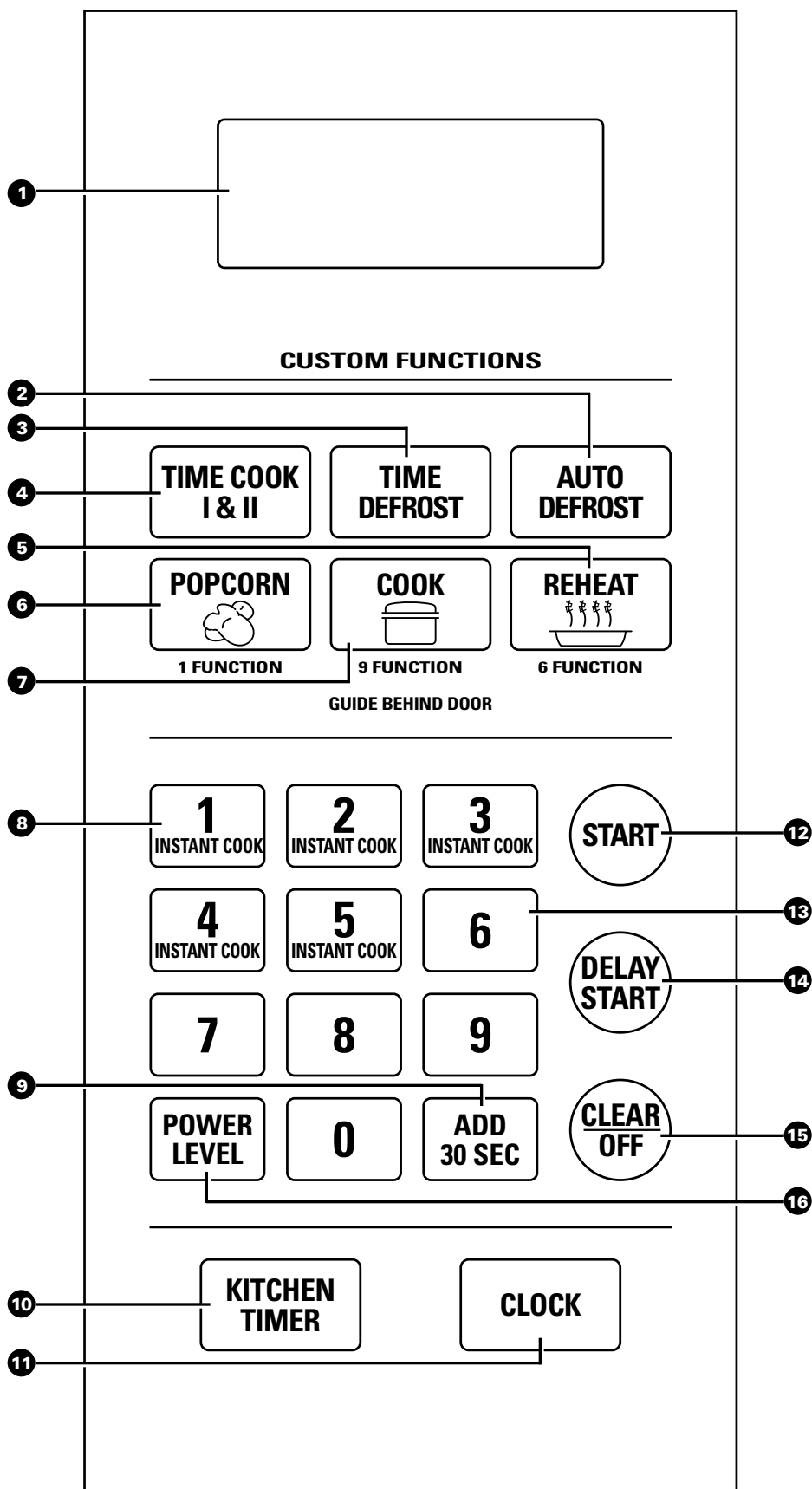

YOUR TOUCH CONTROL PANEL



The Touch Control Panel allows you to set the oven controls with the touch of a finger. It's designed to be easy to use and understand.

1. **DISPLAY.** Displays time of day, cooking time, power level being used, cooking mode and instructions.

Custom Functions

2. **AUTO DEFROST.** Touch this pad and food weight, then START. The oven automatically sets power levels and defrosting time.
3. **TIME DEFROST.** Gentle thawing at automatic Power Level 3 (Low).
4. **TIME COOK I & II.** Microwave for a selected amount of time using automatic Power Level 10 (High).
5. **REHEAT.** Use Reheat for quick reheating of a variety of foods using different times and power levels.
6. **POPCORN.** Touch this pad to cook prepackaged microwave popcorn weighing 3.0 to 3.5 ounces. No need to touch START, the oven will start immediately.
7. **COOK.** Touch this pad, a code number and weight of food for quick cooking of a variety of foods using different times and power levels.

Convenience Features

8. **INSTANT COOK.** Touch number pads 1 through 5 for 1 to 5 minutes of cooking. No need to touch START, the oven will start immediately.
9. **ADD 30 SECONDS.** Press this pad for 30 seconds of cook time, to add 30 seconds to the cook time as it's counting down or for an "instant on" for 30 seconds.
10. **KITCHEN TIMER.** This feature uses no microwave energy. It functions as either a kitchen timer, as a holding period after defrost or as a delay timer before time or temperature cooking.
11. **CLOCK.** Touch this pad to enter time of day or check time of day while microwaving. To set clock, first touch CLOCK pad and then enter time of day. For example, if time is 1:30, touch number pads 1, 3 and 0 and "1:30" will appear in display. Then touch START or CLOCK pad. To reset or change time, simply repeat above process.

Function Controls

12. **START.** After all selections are made, touch this pad to start the oven.
13. **NUMBER PADS.** Touch these pads to program the microwave.
14. **DELAY START.** Allows you to program your oven to begin cooking at a preset time of day—up to a 12-hour delay.
15. **CLEAR/OFF.** When touched, it shuts off the oven and erases all settings (except time of day).
16. **POWER LEVEL.** Touch this pad before entering another power level number if you want to change from automatic Power Level 10 (High) for cooking or Power Level 3 (Low) for defrosting.



AUTO DEFROST

Auto Defrost

With the Auto Defrost feature, the oven automatically sets the defrosting times and power levels for you.

Use the Auto Defrost Guide. Enter the food weight in pounds and tenths of a pound (see Conversion Guide below). Then touch START pad.

The oven calculates defrosting time and changes power levels during defrosting to give even defrosting results.

How to Set Auto Defrost

Before you begin, check the guide located on the inside front of oven when you open the door.

It shows minimum and maximum food weights for a variety of foods. You will need to know your food weight before setting Auto Defrost.

Step 1: Remove food from package, place in oven on microwave-safe dish and close door.



Step 2: Touch AUTO DEFROST pad.

Step 3: Enter weight. For example, touch number pads 1 and 2 for weight of 1.2 pounds (1 pound, 3 ounces). See Conversion Guide below. After approximately 5 seconds “START” flashes.



Step 4: Touch START pad. Display shows defrost time counting down.

Twice during defrosting, the oven beeps 4 times and “TURN” flashes. Follow the directions in the Auto Defrost Guide for what to do at the first and second signal.

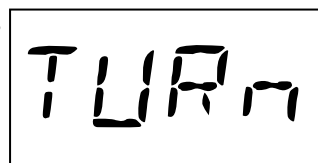

Then close the door and touch START pad.

When defrosting time is completed, “End” flashes and oven beeps 4 times. “End” remains on display and oven beeps every minute until door is opened or CLEAR/OFF pad is touched.

Stand Time

After Auto Defrosting, meat needs to stand in order to let the inside defrost. You may take the food out of the oven if you wish. Stand time recommendations are given in the Auto Defrost Guide.

Conversion Guide

If the weight of food is stated in pounds and ounces, the ounces must be converted to tenths (.1) of a pound.

Ounces	Pounds
1-2	.1
3	.2
4-5	.3
6-7	.4
8	.5
9-10	.6
11	.7
12-13	.8
14-15	.9

AUTO DEFROST GUIDE



RECOMMENDED FOODS	MIN.-MAX. WEIGHT	FIRST SIGNAL	SECOND SIGNAL	STAND TIME
Meat				
Chops	0.1 - 6.0 lbs.	Turn over.	Separate and shield where necessary.	5 minutes
Frankfurters, Sausage	0.1 - 6.0 lbs.	Separate.	Remove defrosted pieces.	2 minutes
Ground Meat	0.1 - 6.0 lbs.	Turn over.	Remove defrosted areas and break apart.	5 minutes
Beef Patties	0.1 - 6.0 lbs.	Turn over.	Separate patties.	5 minutes
Roast	0.1 - 6.0 lbs.	Turn over and shield.	Shield if necessary.	30 minutes
Ribs	0.1 - 6.0 lbs.	Turn over.	Remove defrosted pieces. Shield if necessary.	10 minutes
Steak	0.1 - 6.0 lbs.	Turn over.		5 minutes
Stew	0.1 - 6.0 lbs.	Turn over and separate.	Separate and remove defrosted pieces.	5 minutes
Poultry				
Whole Chicken	0.1 - 6.0 lbs.	Turn over and shield.	Turn over and shield.	10 minutes; run cold water in cavity.
Turkey Breast (breast side up)	0.1 - 6.0 lbs.	Turn over.	Shield where necessary.	20 minutes; run cold water in cavity.
Chicken Pieces	0.1 - 6.0 lbs.	Turn over.	Separate and remove defrosted pieces.	5 minutes
Cornish Hens (whole)	0.1 - 6.0 lbs.	Remove wrapper and turn over.		10 minutes; run cold water in cavity.
Cornish Hens (split)	0.1 - 6.0 lbs.	Turn over.		5 minutes
Seafood				
Fish Fillets	0.1 - 6.0 lbs.	Turn over.	Separate and remove defrosted pieces.	5 minutes
Shrimp, Scallops	0.1 - 6.0 lbs.	Separate.	Separate and remove defrosted pieces.	5 minutes
Whole Fish	0.1 - 6.0 lbs.	Turn over and shield tail and head.		Hold under cold running water.

Edges or thin areas of meat will defrost more rapidly than other areas. After first or second signal, shield warm areas with small pieces of foil.



TIME DEFROST

Time Defrost (Power Level 3)

Time Defrost is designed for speedy thawing of frozen food and is one of the great advantages of a microwave oven.

Use the Time Defrost setting to quickly thaw foods such as bread, rolls, vegetables, fruits and frozen dinners. The Auto Defrost setting is preferred for meat and poultry because the oven sets the defrosting time and power levels for you.

- Power Level 3 is automatically set when you press TIME DEFROST pad, but you may change this for more flexibility.
- See the Defrosting Guide for defrosting help.

How to Change Power Level

1. Press TIME DEFROST.
2. Select defrosting time.
3. Press POWER LEVEL.
4. Select desired power level 1–10.
5. Press START.



To become better acquainted with the defrost function, defrost a 10 oz. package of frozen strawberries by following the steps below.

Step 1: Place a package of frozen strawberries in the oven and close door. Be sure package contains no metal.

Step 2: Touch TIME DEFROST.

TIME DEFROST

Step 3: Select one half of the total defrosting time recommended. For example, touch pads 4, 0 and 0 for 4 minutes.



Step 4: Touch START. When the cycle is completed, the oven signals and flashes “End,” then automatically shuts off.

Step 5: Turn the package over, close the door and repeat Steps 2 and 3 to set remaining half of defrosting time. Touch START.

Step 6: When the oven signals and flashes “End,” open the door, remove the package and separate strawberries to finish defrosting.

Defrosting Tips



- Foods frozen in paper or plastic can be defrosted in the package. Tightly closed packages should be slit, pierced or vented, AFTER food has partially defrosted, as directed by package. Plastic storage containers should be at least partially uncovered.

- Family-size, prepackaged frozen dinners can be defrosted and microwaved. If the food is in a foil container, transfer it to a microwave-safe dish.

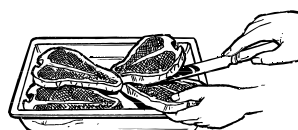

- For even defrosting, some foods need to be broken up or separated part of the way through the defrosting time.
- Foods that spoil easily, such as milk, eggs, fish, stuffings, poultry and pork, should not be allowed to sit out for more than one hour after defrosting. Room temperature promotes the growth of harmful bacteria.
- Check the Defrosting Guide for other defrosting tips.

Questions and Answers

Q. When I press START, I hear a dull thumping noise. What is it?

- A. This sound is normal. It is letting you know the magnetron is in operation.

Q. Can I defrost small items in a hurry?

- A. Yes, but they will need more frequent attention than usual. Raise the power level after entering the time by touching the desired power level pad. Power Level 7 cuts the total defrosting time in about 1/2; Power Level 10 cuts the total defrosting time to approximately 1/3. During either, rotate or stir food frequently.

TIME COOK



Time Cook I

Time Cook allows you to microwave for a preset amount of time.

Power Level 10 (High) is recommended for most cooking, but you may change this for more flexibility. See the Cooking Guide.

To become better acquainted with time cooking, make a cup of coffee by following the steps below.

Step 1: Fill a cup 2/3 full of water, add 1 teaspoon of instant coffee and stir to dissolve. Use a cup that has no metal decoration and is microwave-safe (refer to Microwaving Tips section).

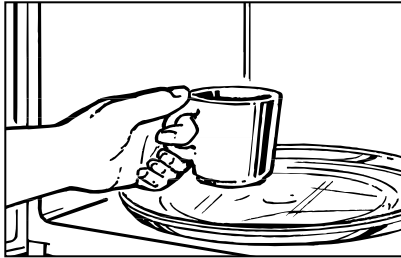

Place cup in oven and close door.

TIME COOK I & II

Step 2: Touch TIME COOK I & II.

Step 3: Select your time. Touch pads 1, 0 and 0 for 1 minute.

Because automatic Power Level 10 is recommended for this cup of coffee, there is no need to change the power level. (If Power Level 10 is not appropriate, see “How to Change Power Level” at right.)

Step 4: Touch START.

START

Step 5: When time is up, the oven signals and flashes “End.” The oven, light and fan shut off.

Step 6: Open the door.

If you interrupt Time Cook to check the food, simply close the door and press START to resume cooking. If there is no time remaining on the timer you must reset the timer to resume cooking.

How to Change Power Level When Setting Time Cook I

The power level may be entered or changed immediately after entering the feature time for TIME COOK I & II, DEFROST or INSTANT COOK. The power level may also be changed during their time countdown.

1. Press TIME COOK I & II.

2. Select cooking time.

3. Press POWER LEVEL.

4. Select desired power level 1–10.

5. Press START.



Using the Time Cook II Feature

The Time Cook II feature lets you set 2 time cooking functions within one program. This is ideal if you want to change power levels during your cooking operations. Here’s how to do it.

Step 1: Place the food in the oven in a microwave-safe container and close the door.

TIME COOK I & II

Step 2: Touch TIME COOK I & II.

Step 3: Select your first cook time. For example, touch 2, 1 and 5 for 2 minutes and 15 seconds.

Step 4: Now is the time to change the power level if you don’t want full power for TIME COOK I. (Press POWER LEVEL. Select desired power level 1–10.)

Step 5: Touch TIME COOK I & II again.

Step 6: Set your second cook time.

Step 7: Change the power level for TIME COOK II. (Press POWER LEVEL. Select desired power level 1–10.)

Step 8: Press START.

START

The microwave oven will start and the time set for “COOK TIME I” will count down. Also, “POWER 10” or the power level selected for “COOK TIME I” will be displayed.

At the end of “COOK TIME I,” the second power level is displayed and the time for “COOK TIME II” is shown counting down.

When time is up, the oven signals and flashes “End.” The oven, light and fan shut off. Open the door.

If you interrupt Time Cook to check the food, simply close the door and press START to resume cooking. If there is no time remaining on the timer you must reset the timer to resume cooking.



REHEAT

The Reheat feature is a short-term program to automatically reheat a previously cooked food. The oven turns off automatically after a preset amount of time.

Touch just three pads to use Reheat codes 1 to 6 to reheat many popular foods. See the Reheat Guide below.

Reheat

The Reheat program makes it a snap to reheat many popular foods. Choose a code number from 1 to 6 (see Reheat Guide below).



Step 1: Touch REHEAT pad.

Step 2: Touch a number pad from 1 to 6 to select a food group.



Step 3: Touch START pad. Oven will signal and turn off automatically when finished.

To Reheat More Than One Serving

Reheat codes 1 through 5 let you heat up to three servings. To add more than one serving, just touch number pad 2 or 3 right before touching START.

The serving size may even be changed or added after touching START. Just touch number pad 2 or 3.

The word “SERV” and a number will be displayed to show how many servings have been selected.

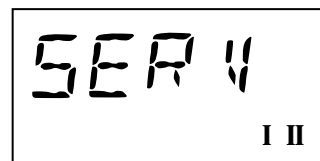

Reheat Guide

Code	Display	Serving Size	Foods Recommended
1	PASTA	1–3	Pasta
2	MEATS	1–3	Meats, casseroles, pizza
3	VEGS	1–3	Fruits and vegetables
4	bEV	1–3	Beverages, 8–10 oz.
5	SAUCE	1–3	Sauces and gravies
6	PLATE	–	2 to 3 foods, 4 oz. each

CAUTION: Reheated foods may have wide variations in temperature. Some areas may be extremely hot.

After removing food from the oven, we recommend that all reheated foods be stirred, if possible, to even out the temperature.

POPCORN



The Popcorn feature is designed to be used only with prepackaged microwave popcorn weighing 3.0 to 3.5 ounces.

Step 1: Remove the outer wrapper from the microwave popcorn.

Step 2: Open oven door and place package of popcorn in the center of the oven floor as directed by the package instructions. Close oven door.



Step 3: Touch POPCORN pad. No need to touch START, the oven will start immediately.

How to Adjust the Popcorn Program to Provide a Shorter or Longer Cook Time

If your favorite popcorn is not completely popped, there is a simple adjustment you can make.

Touch the POPCORN pad. (The oven will start immediately.) Then touch number pad 9. A plus sign will appear on the display beside the word "POP."



The plus sign indicates 20 seconds more cooking time is being provided.

If your favorite popcorn is overcooked, there is a simple adjustment you can make.

Touch the POPCORN pad. (The oven will start immediately.) Then touch number pad 1. A minus sign will appear on the display beside the word "POP."



The minus sign indicates 20 seconds less cooking time is being provided.

COOK

Use the Cook feature when cooking a variety of microwaved foods. The oven automatically sets the cooking times and power levels for you.

Use the Cook Code Guide. Touch the COOK pad. Touch a number pad from 1 to 9 to select the desired food group. Enter the food weight in ounces, then touch the START pad.

The oven calculates cooking time and changes power levels during cooking to give even cooking results.

How to Use the Cook Feature

Step 1: Remove the food from the package, place in the oven on microwave-safe dish and close door.



Step 2: Touch the COOK pad.

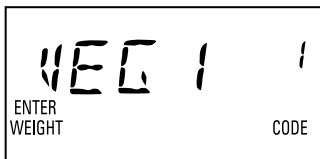

Step 3: Touch number pad of desired food code. For example, touch number pad 1 for canned vegetables. The code number and food type you selected will appear on the display. "ENTER WEIGHT" will flash.



Step 4: Enter weight. For example, touch 1 and 8 for 18 ounces. After 5 seconds "START" flashes on the display.



Step 5: Touch the START pad. Oven will begin cooking. Touching the COOK pad during cooking will display the remaining Cook time. Oven displays "End" when cooking is done.

(continued next page)



COOK

(continued)

Cook Code Guide

Food	Cook Code	Weight Limit (oz.)	Comments
Canned Vegetables	1	4 to 20 oz.	Use microwave-safe casserole or bowl. Cover with lid or plastic wrap.
Frozen Vegetables	2	4 to 16 oz.	Use microwave-safe casserole or bowl. Follow package instructions for adding water. Cover with lid or plastic wrap.
Fresh Vegetables	3	4 to 16 oz.	Use microwave-safe casserole or bowl. Add 2 tablespoons water for each serving. Cover with lid or plastic wrap.
Potatoes	4	8 to 40 oz.	Pierce skin with fork. Place side by side on the turntable.
Fish	5	4 to 16 oz.	Use oblong, square or round dish. Cover with plastic wrap.
Chicken Pieces	6	4 to 40 oz.	Use oblong, square or round dish. Cover with plastic wrap.
Ground Meat (Beef, Pork, Turkey)	7	8 to 48 oz.	Use round casserole dish. Crumble meat into dish. Cover with plastic wrap.
Bacon	8	2 to 10 oz.	Layer strips on a plate, 4 to a layer. Cover each layer with a paper towel.
Pizza (frozen microwaveable)	9	4 to 16 oz.	Follow package instructions to prepare pizza for microwaving.

INSTANT COOK

The Instant Cook feature is a short-cut method to set time for 1–5 minutes at Power Level 10.



To Instant Cook your food or beverage:

Touch a number pad (from 1 to 5) for 1 to 5 minutes of cooking at Power Level 10. For example, touch the 2 pad for 2 minutes of cooking time. No need to touch START, the oven will start immediately.

The oven will signal and turn off automatically when finished.

ADD 30 SECONDS

The Add 30 Seconds feature provides a convenient way to extend cooking time by 30 seconds while the oven timer is counting down. It will add 30 seconds to the time shown each time the pad is touched.

This pad may also be used as an instant cook for 30 seconds of cooking. No need to touch START, the oven will start immediately.

KITCHEN TIMER



The Kitchen Timer

The Kitchen Timer has three timing functions:

- It operates as a minute timer.
- It can be set to delay cooking.
- It can be used as a hold setting after defrosting.

The Kitchen Timer operates without microwave energy.

Using a Holding Time

The Kitchen Timer can also be used to program a “holding time” between microwave cooking functions. The time can range from one second to 99 minutes and 99 seconds. A holding or standing time may be found in some of your own recipes or in a cookbook.

How to Time a 3-Minute Phone Call



Step 1: Touch KITCHEN TIMER pad.



Step 2: Touch number pads 3, 0 and 0 (for 3 minutes and no seconds).



Step 3: Touch START. Display shows time counting down. The timer signals when time is up.

Programming Delayed Cooking

To delay cooking up to 99 minutes and 99 seconds, touch TIME COOK I & II and enter cook time. Touch KITCHEN TIMER and enter number of minutes to delay cooking. Touch START. Timer will count down to zero and cooking will begin.

How to Defrost, Hold and Time Cook

Let's say you want to defrost a frozen casserole for 15 minutes, hold for 10 minutes and then Time Cook for 25 minutes. Here's how to do it:

Step 1: Take casserole from freezer and place in oven.



Step 2: Touch TIME DEFROST.



Step 3: Touch pads 1, 5, 0 and 0 for 15 minutes defrosting time. (Defrosting is automatically set on Power Level 3 but can be changed by touching the POWER LEVEL pad and the desired power level 1–10.)



Step 4: Set standing or hold time by touching KITCHEN TIMER.

Step 5: Touch 1, 0, 0 and 0 to hold for ten minutes.



Step 6: Touch TIME COOK I & II.

Step 7: Touch 2, 5, 0 and 0 for 25 minutes of cooking time.



Step 8: Touch START. As each function is automatically performed, oven display shows instructions entered and the function. When time is up, the oven signals and flashes “End.”

DELAY START

The Delay Start feature allows you to program your oven to begin cooking at a preset time of day—up to a 12-hour delay.

Step 1: Touch DELAY START pad.



Step 2: Enter the time you want the oven to start. (Be sure your microwave oven clock shows the correct time of day.)

Step 3: Enter your desired cooking program.

Step 4: Touch START pad. The display will show the time you entered. The time of day may be displayed by touching the CLOCK pad. The oven will automatically start at the desired time.



GLOSSARY OF MICROWAVE TERMS

When adapting recipes for the microwave, it is best to start with a familiar recipe. Knowing how the food should look and taste will help when adapting recipes for microwaving. Foods that require browning or crisp, dry surfaces will cook better in regular ovens.

- Moist foods, such as vegetables, fruits, poultry and seafood, microwave well.
- Rich foods, such as bar cookies, moist cakes and candies, are suitable for microwaving because of their high fat and sugar content.
- Reduce regular oven cooking times by 1/2 to 1/3. Check food after minimum time to avoid over-cooking.
- Small amounts of butter or oil can be used for flavoring, but are not needed to prevent sticking.
- Seasonings may need to be reduced. Salt meats and vegetables after cooking.

Covering. In both regular baking and microwave cooking, covers hold in moisture, allow for more even heating and reduce cooking time. In regular ovens, partial covering allows excess steam to escape. Venting plastic wrap or covering with wax paper serves the same purpose when microwaving.

Venting. After covering a dish with plastic wrap, you vent the plastic wrap by turning back 1 corner so excess steam can escape.

Arranging Food in Oven. When baking in regular ovens, you position foods, such as cake layers or potatoes, so hot air can flow around them. When microwaving, you arrange foods in a ring, so that all sides are exposed to microwave energy.

Stirring. In range-top cooking, you stir foods up from the bottom to heat them evenly. When microwaving, you stir cooked portions from the outside to the center. Foods that require constant stirring will need only occasional stirring when microwaving.

Turning Over. In range-top cooking, you turn over foods, such as hamburgers, so both sides can directly contact the hot pan. When microwaving, turning is often needed during defrosting or when cooking certain foods, such as frozen hamburgers.

Standing Time. When you cook with regular ovens, foods such as roasts or cakes are allowed to stand to finish cooking or to set. Standing time is especially important in microwave cooking. Note that a microwaved cake is not placed on a cooling rack.

Shielding. In a regular oven, you shield chicken breasts or baked foods to prevent over-browning. When microwaving, you use small strips of foil to shield thin parts, such as the tips of wings and legs on poultry, which would cook before larger parts.

Arcing. Sparks caused by too much metal in the microwave oven or metal touching the side of the oven or foil that is not molded to food.

Prick Foods to Release Pressure. Steam builds up pressure in foods that are tightly covered by a skin or membrane. Prick foods, such as potatoes (as you do before regular oven cooking), egg yolks and chicken livers, to prevent bursting.

Basic Microwave Guidelines

Density of Food. In both regular baking and microwave cooking, dense foods, such as potatoes, take longer to cook than light, porous foods, such as rolls, bread or pieces of cake.

Round Shapes. Since microwaves penetrate foods to about 1 inch from top, bottom and sides, round shapes and rings cook more evenly. Corners receive more energy and may overcook. This may also happen when cooking in a regular oven.

Delicacy. Foods with a delicate texture, such as custards, are best cooked at lower power settings to avoid toughening.

Natural Moisture of food affects how it cooks. Very moist foods cook evenly because microwave energy is attracted to water molecules. Food that is uneven in moisture should be covered or allowed to stand so it heats evenly.

Piece Size. Small pieces cook faster than large ones. Pieces that are similar in size and shape cook more evenly. With large pieces of food, reduce the power setting for even cooking.

Shape of Food. In both types of cooking, thin areas cook faster than thick areas. This can be controlled in microwaving by placing thick pieces near the outside edge and thin pieces in the center.

Starting Temperature. Foods taken from the freezer or refrigerator take longer to cook than foods at room temperature. Timings in our recipes are based on the temperatures at which you normally store the foods.

Quantity of Food. In both types of cooking, small amounts usually take less time than large amounts. This is most apparent in microwave cooking, where time is directly related to the number of servings.

HEATING OR REHEATING GUIDE

NOTE: Use Power Level High (10) unless otherwise noted.



- Directions below are for heating or reheating already-cooked foods stored in refrigerator or at room temperature. Use microwave-safe cookware.
- Cover most foods for fastest heating. Exceptions are some sandwiches, griddle foods and baked items.
- Bubbling around edges of dish is normal, since the center is the last to heat. Foods heated to 160°F. to 165°F. will provide safe, palatable results.

Adjust temperatures to suit your personal taste. Let foods stand a few minutes before serving.

- Be sure foods are heated throughout before serving. Steaming or bubbling around edges of dish does not necessarily mean food is heated throughout.

If you use a meat thermometer while cooking, make sure it is safe for use in microwave ovens.

Item	Amount	Power Level	Time
Bakery Foods			
Cake, coffee cake, doughnuts, sweet rolls, nut or fruit bread	1 piece	Low (3)	1/4 to 1 min.
	9 inch cake or 12 rolls or doughnuts	Low (3)	1 1/2 to 4 min.
Dinner rolls, muffins	1	Medium (5)	1/4 to 1/2 min.
	6 to 8	Medium (5)	1/2 to 2 min.
Pie: fruit, nut or custard; 1 slice=1/8 of 9 inch pie (use minimum time for custard)	1 slice		1/4 to 1 min.
	9 inch pie	Med-High (7)	4 to 7 min.
Beverages			
Cocoa, other milk-based drinks (6 oz. per cup)	1 to 2 cups	Med-High (7)	1 1/2 to 5 min.
Coffee, other water-based drinks (6 oz. per cup)	1 to 2 cups		1/2 to 3 min.
Meats and Main Dishes			
Chicken pieces	1 to 2 pieces		1 1/2 to 3 min.
Hamburgers or meatloaf (4 oz. per serving)	1 to 2 servings		1 1/2 to 3 min.
Hot dogs and sausages	1 to 2		1/4 to 1 min.
Rice and pasta (2/3-3/4 cup per serving)	1 to 2 servings		1/2 to 3 min.
Saucy, main dishes: chop suey, spaghetti, creamed chicken, chili, stew, macaroni and cheese, etc. (3/4-1 cup per serving)	1 to 2 servings		2 1/2 to 5 min.
Steaks, chops, ribs, meat pieces	1 to 2 servings	Med-High (7)	1 1/2 to 4 min.
Thinly-sliced meat (3 to 4 oz. per serving)	1 to 2 servings	Med-High (7)	1/2 to 3 min.
Topped or mixed with sauce (2/3-3/4 cup per serving)	1 to 2 servings		2 to 5 min.
Tip: Cover saucy main dishes with plastic wrap. Cover other main dishes and meats with wax paper. When heating or reheating 3 to 4 servings of meat slices or pieces, rotate dish 1/2 turn after half of cooking time.			
Plate of Leftovers			
Meat plus 2 vegetables	1 plate		1 1/2 to 4 min.
Tip: Cover plate of food with wax paper or plastic wrap.			
Sandwiches			
Meat-cheese filling: with 2 slices of bread	1 to 2 servings	Med-High (7)	1/2 to 3 min.
Moist filling: Sloppy Joes, barbecue, ham salad, etc. in bun (1/3 cup per serving)	1 to 2 servings	Med-High (7)	1/2 to 2 min.
Tip: Use paper towel or napkin to cover sandwiches.			
Soups			
Milk-based (6 oz. per serving)	1 to 2 servings	Med-High (7)	1 1/2 to 3 min.
Water-based (6 oz. per serving)	1 to 2 servings		1 to 3 min.
Tip: Cover soups with wax paper or plastic wrap.			
Vegetables			
Large pieces or whole: asparagus spears, corn on the cob, etc.	1 to 2 servings		1/2 to 2 min.
Mashed (1/2 cup per serving)	1 to 2 servings		1/2 to 2 min.
Small pieces: peas, beans, corn, etc. (1/2 cup per serving)	1 to 2 servings		1/2 to 2 min.
Tip: Cover vegetables for most even heating.			



DEFROSTING GUIDE

1. Food packaged in paper or plastic may be defrosted without unwrapping. If food is foil wrapped, remove foil and place food in cooking dish for defrosting. Most food defrosts well using Defrost (3). For more even defrosting of larger foods, such as beef, lamb and veal roasts, use Warm (1).
2. After first half of defrosting time, unwrap package and check food. Turn food over, if necessary; break apart or separate food if possible. Shield any warm areas with small pieces of foil.
3. Be sure large meats are completely defrosted before cooking.
4. When defrosted, food should be cool but softened in all areas. If still slightly icy, return to microwave oven very briefly, or let stand a few minutes.

Food	Time	Comments
Breads, Cakes [Power Level: Defrost (3)]		
Bread, buns or rolls (1 piece)	1/4 min.	
Sweet rolls (approx. 12 oz.)	2 to 6 min.	Rearrange after half of time.
Fish and Seafood [Power Level: Defrost (3)]		
Fillets , frozen (1 lb.)	7 to 12 min.	
Shellfish , small pieces (1 lb.)	4 to 8 min.	Place block in casserole. Turn over and break up after first half of time.
Fruit [Power Level: Defrost (3)]		
Plastic pouch —1 to 2 (10-oz. package)	3 to 7 min.	
Meat [Power Level: Defrost (3)]		
Bacon (1 lb.)	2 to 5 min.	Place unopened package in oven. Let stand 5 minutes after defrosting.
Franks (1 lb.)	2 to 5 min.	Place unopened package in oven. Microwave just until franks can be separated. Let stand 5 minutes, if necessary, to complete defrosting.
Ground meat (1 lb.)	5 to 8 min.	Turn meat over after first half of time.
Roast : beef, lamb, veal, pork	10 to 16 min. per lb.	Use Power Level Warm (1).
Steaks , chops and cutlets	5 to 10 min. per lb.	Place unwrapped meat in cooking dish. Turn over after first half of time and shield warm areas with foil. After second half of time, separate pieces with table knife. Let stand to complete defrosting.
Poultry [Power Level: Defrost (3)]		
Chicken , broiler-fryer, cut up (2½ to 3 lbs.)	14 to 22 min.	Place wrapped chicken in dish. Unwrap and turn over after first half of time. After second half of time, separate pieces and place in cooking dish. Microwave 2 to 4 minutes more, if necessary. Let stand a few minutes to finish defrosting.
Chicken , whole (2½ to 3 lbs.)	20 to 28 min.	Place wrapped chicken in dish. After first half of time, unwrap and turn chicken over. Shield warm areas with foil. To complete defrosting, run cool water in cavity until giblets can be removed.
Cornish hen	7 to 16 min. per lb.	Place unwrapped hen in oven breast-side-up. Turn over after first half of time. Run cool water in cavity until giblets can be removed.
Turkey breast (4 to 6 lbs.)	4 to 10 min. per lb.	Place unwrapped breast in microwave-safe dish breast-side-down. After first half of time, turn breast-side-up and shield warm areas with foil. Defrost for second half of time. Let stand 1 to 2 hours in refrigerator to complete defrosting.

COOKING GUIDE

NOTE: Use Power Level High (10) unless otherwise noted.

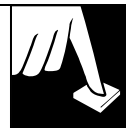

Vegetables

Vegetable	Amount	Time	Comments
Asparagus (fresh spears)	1 lb.	6 to 10 min., Med-High (7)	In 1½-qt. oblong glass baking dish, place 1/4 cup water. Rotate dish after half of time.
(frozen spears)	10-oz. package	5 to 8 min.	In 1-qt. casserole.
Beans (fresh green)	1 lb. cut in half	10 to 15 min.	In 1½-qt. casserole, place 1/2 cup water.
(frozen green)	10-oz. package	6 to 9 min.	In 1-qt. casserole, place 2 tablespoons water.
(frozen lima)	10-oz. package	6 to 9 min.	In 1-qt. casserole, place 1/4 cup water.
Beets (fresh, whole)	1 bunch	18 to 25 min.	In 2-qt. casserole, place 1/2 cup water.
Broccoli (fresh cut)	1 bunch (1/4 to 1½ lbs.)	6 to 9 min.	In 2-qt. casserole, place 1/2 cup water.
(fresh spears)	1 bunch (1/4 to 1½ lbs.)	8 to 12 min.	In 2-qt. oblong glass baking dish, place 1/4 cup water. Rotate dish after half of time.
(frozen, chopped)	10-oz. package	5 to 8 min.	In 1-qt. casserole.
(frozen spears)	10-oz. package	5 to 8 min.	In 1-qt. casserole, place 3 tablespoons water.
Cabbage (fresh)	1 medium head (about 2 lbs.)	7 to 10 min.	In 1½- or 2-qt. casserole, place 1/4 cup water.
(wedged)		6 to 9 min.	In 2- or 3-qt. casserole, place 1/4 cup water.
Carrots (fresh, sliced)	1 lb.	6 to 9 min.	In 1½-qt. casserole, place 1/4 cup water.
(frozen)	10-oz. package	5 to 8 min.	In 1-qt. casserole, place 2 tablespoons water.
Cauliflower (flowerets)	1 medium head	8 to 13 min.	In 2-qt. casserole, place 1/2 cup water.
(fresh, whole)	1 medium head	8 to 16 min.	In 2-qt. casserole, place 1/2 cup water.
(frozen)	10-oz. package	5 to 8 min.	In 1-qt. casserole, place 2 tablespoons water.
Corn (frozen kernel)	10-oz. package	4 to 8 min.	In 1-qt. casserole, place 2 tablespoons water.
Corn on the cob (fresh)	1 to 5 ears	3 to 5 min. per ear	In 2-qt. oblong glass baking dish, place corn. If corn is in husk, use no water; if corn has been husked, add 1/4 cup water. Rearrange after half of time.
(frozen)	1 ear 2 to 6 ears	5 to 7 min. 2 to 4 min. per ear	Place in 2-qt. oblong glass baking dish. Cover with vented plastic wrap. Rearrange after half of time.
Mixed, vegetables (frozen)	10-oz. package	4 to 8 min.	In 1-qt. casserole, place 3 tablespoons water.
Peas (fresh, shelled)	2 lbs. unshelled	8 to 11 min.	In 1-qt. casserole, place 1/4 cup water.
(frozen)	10-oz. package	4 to 8 min.	In 1-qt. casserole, place 2 tablespoons water.
Potatoes (fresh, cubed, white)	4 potatoes (6 to 8 oz. each)	10 to 14 min.	Peel and cut into 1 inch cubes. Place in 2-qt. casserole with 1/2 cup water. Stir after half of time.
(fresh, whole, sweet or white)	1 (6 to 8 oz.)	2 to 5 min.	Pierce with cooking fork. Place in center of the oven. Let stand 5 minutes.
Spinach (fresh)	10 to 16 oz.	4 to 8 min.	In 2-qt. casserole, place washed spinach.
(frozen, chopped and leaf)	10-oz. package	4 to 8 min.	In 1-qt. casserole, place 3 tablespoons water.
Squash (fresh, summer and yellow)	1 lb. sliced	4 to 7 min.	In 1½-qt. casserole, place 1/4 cup water.
(winter, acorn or butternut)	1 to 2 squash (about 1 lb. each)	7 to 11 min.	Cut in half and remove fibrous membranes. In 2-qt. oblong glass baking dish, place squash cut-side-down. Turn cut-side-up after 4 minutes.



CARE AND CLEANING



Keep your oven clean and sweet-smelling. Opening the oven door a few minutes after cooking helps air out the inside. An occasional thorough wiping with a solution of baking soda and water keeps the inside fresh.

Do not use sharp-edged utensils on your oven. The inside and outside oven walls can be scratched. The control panel can be damaged.

BE CERTAIN POWER IS OFF BEFORE CLEANING ANY PART OF THIS OVEN.

How to Clean the Inside

Walls and floor. Some spatters can be removed with a paper towel, others may require a damp cloth. Remove greasy spatters with a sudsy cloth, then rinse with a damp cloth. Do not use abrasive cleaners on oven walls. **NEVER USE A COMMERCIAL OVEN CLEANER ON ANY PART OF YOUR MICROWAVE OVEN.**

Door (inside). Window: Wipe up spatters daily and wash with a damp cloth when soiled. Rinse thoroughly and dry.

Metal and plastic parts on door: Wipe frequently with a damp cloth to remove all soil. **DO NOT USE ABRASIVES, SUCH AS CLEANING POWDERS OR STEEL AND PLASTIC PADS. THEY WILL DAMAGE THE SURFACE.**

Removable Turntable and Turntable Support.

Occasionally it is necessary to remove the turntable and support for cleaning of the oven floor or turntable. To prevent breakage, do not place the turntable into water just after cooking. Wash it carefully in warm, sudsy water or in the dishwasher. The turntable and support can be broken if dropped. Remember, do not operate the oven without the turntable and support in place.

Special note when using Brown 'N Sear Dish:

If grease is present, high heat generated on bottom of a Brown 'N Sear dish may cause the grease to burn onto the oven tray. This may be removed with a cleanser such as Bon Ami® brand cleanser.

After using Bon Ami® brand cleanser, rinse and dry thoroughly, following instructions on can. Do not use Bon Ami® brand cleanser on the painted surfaces such as the walls. It may scratch the paint.

How to Clean the Outside

Case. Clean the outside of your oven with soap and a damp cloth, rinse with a damp cloth and then dry. Wipe the window clean with a damp cloth.

Control Panel. Wipe with a damp cloth. Dry thoroughly. Do not use cleaning sprays, large amounts of soap and water, abrasives or sharp objects on the panel—they can damage it.

Door Surface. When cleaning surfaces of door and oven that come together on closing the door, use only mild, non-abrasive soaps or detergents applied with a sponge or soft cloth.

Power Cord. If the cord becomes soiled, unplug and wash with a damp cloth. For stubborn spots, sudsy water may be used, but be certain to rinse with a damp cloth and dry thoroughly before plugging cord into outlet.

GROUNDING INSTRUCTIONS

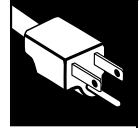

This appliance must be grounded. In the event of an electrical short circuit, grounding reduces the risk of electric shock by

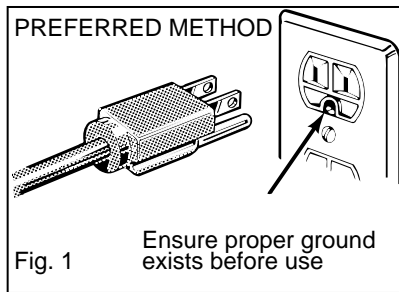

providing an escape wire for the electric current. This appliance is equipped with a power cord having a grounding wire with a grounding plug. The plug must be plugged into an outlet that is properly installed and grounded. (Fig. 1)

WARNING—Improper use of the grounding plug can result in a risk of electric shock.

Consult a qualified electrician or service technician if the grounding instructions are not completely understood, or if doubt exists as to whether the appliance is properly grounded.

Where a standard two-prong wall receptacle is encountered, it is your personal responsibility and obligation to have it replaced with a properly grounded three-prong wall receptacle.

Do not under any circumstances cut or remove the third (ground) prong from the power cord.

Use of Adapter Plugs

Usage situations where appliance's power cord will be disconnected infrequently.

Because of potential safety hazards under certain conditions, **we strongly recommend against the use of an adapter plug.** However, if you still elect to use an

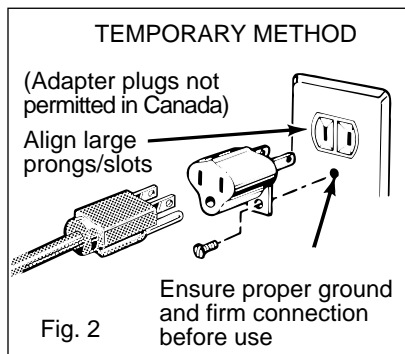

adapter, where local codes permit, a **TEMPORARY CONNECTION** may be made to a properly grounded two-prong wall receptacle by the use of a UL listed adapter (Fig. 2) which is available at most local hardware stores.

The larger slot in the adapter must be aligned with the larger slot in the wall receptacle to provide proper polarity in the connection of the power cord.

CAUTION: Attaching the adapter ground terminal to the wall receptacle cover screw does not ground the appliance unless the cover screw is metal, and not insulated, and the wall receptacle is grounded through the house wiring. You should have the circuit checked by a qualified electrician to make sure the receptacle is properly grounded.

When disconnecting the power cord from the adapter, always hold the adapter with one hand. If this is not done, the adapter ground terminal is very likely to break with repeated use. Should this happen, **DO NOT USE** the appliance until a proper ground has again been established.

Usage situations where appliance's power cord will be disconnected frequently.

Do not use an adapter plug in these situations because frequent disconnection of the power cord places undue strain on the adapter and leads to eventual failure of the adapter ground terminal. You should have the two-prong wall receptacle replaced with a three-prong (grounding) receptacle by a qualified electrician before using the appliance.

Use of Extension Cords

A short power-supply cord is provided to reduce the risks resulting from becoming entangled in or tripping over a longer cord.

Extension cords may be used if you are careful in using them.

If an extension cord is used—

1. The marked electrical rating of the cord set or extension cord should be at least as great as the electrical rating of the appliance.

2. The extension cord must be a grounding-type 3-wire cord and it must be plugged into a 3-slot outlet.
3. The longer cord should be arranged so that it will not drape over the counter top or tabletop where it can be pulled on by children or tripped over unintentionally.

If you use an extension cord, the interior light may flicker and the blower sound may vary when the microwave oven is on. Cooking times may be longer, too.



QUESTIONS? USE THIS PROBLEM SOLVER

PROBLEM	POSSIBLE CAUSE
OVEN WILL NOT COME ON	<ul style="list-style-type: none">• A fuse in your home may be blown or the circuit breaker tripped. Replace fuse or reset circuit breaker.• Unplug your microwave oven, then plug it back in.• Make sure 3-prong plug on oven is fully inserted into wall receptacle.
CONTROL PANEL LIGHTED, YET OVEN WILL NOT START	<ul style="list-style-type: none">• Door not securely closed.• START pad must be touched after entering cooking selection.• Another selection entered already in oven and CLEAR/OFF pad not touched to cancel it.• Make sure you have entered cooking time after touching TIME COOK I & II pad.• CLEAR/OFF pad was touched accidentally. Reset cooking program and touch START pad.• Make sure you entered a code number after touching REHEAT or the weight after touching AUTO DEFROST.

All these things are normal with your microwave oven:

- Steam or vapor escaping from around the door.
- Light reflection around door or outer case.
- Dimming oven light and change in blower sound may occur while operating at power levels other than high.
- Dull thumping sound while oven is operating.
- Some TV-Radio interference might be noticed while using your microwave oven. It's similar to the interference caused by other small appliances and does not indicate a problem with your oven.

If you need more help...call, toll free: GE Answer Center® / 800.626.2000 / consumer information service

NOTES

NOTES

We'll Be There

With the purchase of your new GE appliance, receive the assurance that if you ever need information or assistance from GE, we'll be there. All you have to do is call—toll-free!

GE Answer Center[®] **800.626.2000**

Whatever your question about any GE major appliance, GE Answer Center[®] information service is available to help. Your call—and your question—will be answered promptly and courteously. And you can call any time. GE Answer Center[®] service is open 24 hours a day, 7 days a week.

In-Home Repair Service **800-GE-CARES (800-432-2737)**

A GE consumer service professional will provide expert repair service, scheduled at a time that's convenient for you. Many GE Consumer Service company-operated locations offer you service today or tomorrow, or at your convenience (7:00 a.m. to 7:00 p.m. weekdays, 9:00 a.m. to 2:00 p.m. Saturdays). Our factory-trained technicians know your appliance inside and out—so most repairs can be handled in just one visit.

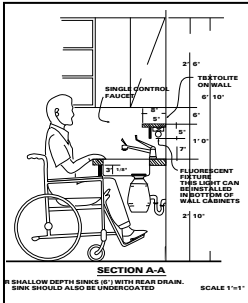

For Customers With Special Needs... **800.626.2000**

Upon request, GE will provide Braille controls for a variety of GE appliances, and a brochure to assist in planning a barrier-free kitchen for persons with limited mobility. To obtain these items, free of charge, call 800.626.2000.

Consumers with impaired hearing or speech who have access to a TDD or a conventional teletypewriter may call 800-TDD-GEAC (800-833-4322) to request information or service.

Service Contracts **800-626-2224**

You can have the secure feeling that GE Consumer Service will still be there after your warranty expires. Purchase a GE contract while your warranty is still in effect and you'll receive a substantial discount. With a multiple-year contract, you're assured of future service at today's prices.

Parts and Accessories **800-626-2002**

Individuals qualified to service their own appliances can have parts or accessories sent directly to their home. The GE parts system provides access to over 47,000 parts...and all GE Genuine Renewal Parts are fully warranted. VISA, MasterCard and Discover cards are accepted.

User maintenance instructions contained in this booklet cover procedures intended to be performed by any user. Other servicing generally should be referred to qualified service personnel. Caution must be exercised, since improper servicing may cause unsafe operation.

YOUR GE MICROWAVE OVEN WARRANTY

Staple sales slip or cancelled check here. Proof of original purchase date is needed to obtain service under warranty.

WHAT IS COVERED

LIMITED ONE-YEAR WARRANTY

For one year from date of original purchase, we will provide, free of charge, parts and service labor to repair or replace **any part of the microwave oven** that fails because of a manufacturing defect.

LIMITED ADDITIONAL FOUR-YEAR WARRANTY

For the second through fifth year from date of original purchase, we will provide, free of charge, a replacement **magnetron tube** if the magnetron tube fails because of a manufacturing defect. You pay for any service labor charges.

For each of the above warranties:

To avoid any trip charges, you must take the microwave oven to a General Electric Factory Service Center or a General Electric Customer Care® servicer and pick it up following service. In-home service is also available, but you must pay for the service technician's travel costs to your home.

This warranty is extended to the original purchaser and any succeeding owner for products purchased for use in the 48 mainland states, Alaska, Hawaii and Washington, D.C.

All warranty service will be provided by our Factory Service Centers or by our authorized Customer Care® servicers during normal working hours.

Should your appliance need service, during warranty period or beyond, call 800-GE-CARES (800-432-2737).

WHAT IS NOT COVERED

- Service trips to your home to teach you how to use the product.

Read your Use and Care material.

If you then have any questions about operating the product, please contact your dealer or our Consumer Affairs office at the address below, or call, toll free:

GE Answer Center®

800.626.2000

consumer information service

- Improper installation.

If you have an installation problem, contact your dealer or installer. You are responsible for providing adequate electrical, exhausting and other connecting facilities.

- Replacement of house fuses or resetting of circuit breakers.

- Failure of the product if it is used for other than its intended purpose or used commercially.

- Damage to product caused by accident, fire, floods or acts of God.

WARRANTOR IS NOT RESPONSIBLE FOR CONSEQUENTIAL DAMAGES.

Some states do not allow the exclusion or limitation of incidental or consequential damages, so the above limitation or exclusion may not apply to you. This warranty gives you specific legal rights, and you may also have other rights which vary from state to state. To know what your legal rights are in your state, consult your local or state consumer affairs office or your state's Attorney General.

Warrantor: General Electric Company

**If further help is needed concerning this warranty, write:
Manager—Consumer Affairs, GE Appliances, Louisville, KY 40225**

Part No. 164D2966P225

Pub No. 49-8710

10-95 CG

JES1143

Printed in Malaysia

Free Manuals Download Website

<http://myh66.com>

<http://usermanuals.us>

<http://www.somanuals.com>

<http://www.4manuals.cc>

<http://www.manual-lib.com>

<http://www.404manual.com>

<http://www.luxmanual.com>

<http://aubethermostatmanual.com>

Golf course search by state

<http://golfingnear.com>

Email search by domain

<http://emailbydomain.com>

Auto manuals search

<http://auto.somanuals.com>

TV manuals search

<http://tv.somanuals.com>