

Owner's Manual

Countertop
Microwave Oven

ZEM200 Series



Monogram®
We bring good things to life.

Introduction

Your new Monogram microwave oven makes an eloquent statement of style, convenience and kitchen planning flexibility. Whether you chose it for its purity of design, practical cooking features or assiduous attention to detail—or for all of these reasons—you'll find that your Monogram microwave oven's superior blend of form and function will delight you for years to come.

The information on the following pages will help you operate and maintain your microwave oven properly.

Contents

Adapter Plugs	7	Start/Pause	20
Aluminum Foil	5, 15, 22	Timer On/Off	21
Appliance Registration	3	Turntable	21
Auto Feature	17	Power Levels	11
Auto Defrost	17	Precautions to Avoid Possible Exposure to Excessive Microwave Energy	2
Care and Cleaning	23	Problem Solver	24
Consumer Services	3, 27	Time Features	12–16
Cooking Controls	10	Add 30 Seconds	16
Extension Cords	8	Express Cook	16
Features of Your Oven	9	Time Cook	12, 13
Grounding Instructions	7	Time Defrost	14, 15
Microwave-Safe Cookware	6	Sensor Features	18, 19
Model and Serial Number Location	3	Beverage	18
Other Features	20, 21	Chicken/Fish	19
Child Lock-Out	20	Popcorn	18
Clock	20	Potato	19
Cooking Complete Reminder	20	Reheat	19
Delay Start	21	Vegetable	19
Help	20	Safety Instructions	4–8
Reminder	21	Warranty	Back Cover
Scroll Speed	20		

PRECAUTIONS TO AVOID POSSIBLE EXPOSURE TO EXCESSIVE MICROWAVE ENERGY

- (a) **Do Not Attempt** to operate this oven with the door open since open-door operation can result in harmful exposure to microwave energy. It is important not to defeat or tamper with the safety interlocks.
- (b) **Do Not Place** any object between the oven front face and the door or allow soil or cleaner residue to accumulate on sealing surfaces.
- (c) **Do Not Operate** the oven if it is damaged. It is particularly important that the oven door close properly and that there is no damage to the:
 - (1) door (bent),
 - (2) hinges and latches (broken or loosened),
 - (3) door seals and sealing surfaces.
- (d) **The Oven Should Not** be adjusted or repaired by anyone except properly qualified service personnel.

*Before
using
your
oven*

Read this manual carefully. It is intended to help you operate and maintain your new microwave oven properly.
Keep it handy for answers to your questions.

*Write
down the
model &
serial
numbers*

See the Features of Your Oven section for model and serial number location.

These numbers are also on the Consumer Product Ownership Registration Card included in this manual.

Before sending in this card, please write these numbers here:

Model Number

Serial Number

Use these numbers in any correspondence or service calls concerning your microwave oven.

*If you
received a
damaged
oven*

Immediately contact the dealer (or builder) that sold you the oven.

*Save time
& money*

Before you request service, check the Problem Solver in the back of this manual.

It lists causes of minor operating problems that you can correct yourself.

*If you
need
service*

To obtain service, see the Consumer Services page in the back of this manual.

We're proud of our service and want you to be pleased. If for some reason you are not happy with the service you receive, here are the steps to follow for further help.

FIRST, contact the people who serviced your appliance. Explain why you are not pleased. In most cases, this will solve the problem.

NEXT, if you are still not pleased, write all the details—including your phone number—to:

Manager, Customer Relations
GE Appliances
Appliance Park
Louisville, KY 40225

IMPORTANT SAFETY INSTRUCTIONS

SAFETY PRECAUTIONS

When using electrical appliances, basic safety precautions should be followed, including the following:

▲ WARNING—To reduce the risk of burns, electric shock, fire, injury to persons or exposure to excessive microwave energy:

- **Read and follow** the specific “Precautions to Avoid Possible Exposure to Excessive Microwave Energy” on page 2.
- **This appliance must be grounded.** Connect only to properly grounded outlet. See Grounding Instructions section on page 7.
- **Install or locate this appliance only in accordance with the provided Installation Instructions.**
- **Be certain to place the front surface of the door three inches or more back from the countertop edge to avoid accidental tipping of the appliance in normal usage.**
- **Use this appliance only for its intended use as described in this guide.** Do not use corrosive chemicals or vapors in this appliance. This microwave oven is specifically designed to heat, dry or cook food, and is not intended for laboratory or industrial use.
- **Do not cover or block any openings on the appliance.**
- **Do not store this appliance outdoors.** Do not use this product near water—for example, in a wet basement, near a swimming pool, near a sink or in similar locations.
- **This microwave oven is not approved or tested for marine use.**
- **Do not immerse power cord or plug in water.**
- **Keep power cord away from heated surfaces.**
- **Do not mount the microwave oven over or near any portion of a heating or cooking appliance.**
- **Do not mount this appliance over a sink.**
- **Do not store anything directly on top of the microwave oven surface when the microwave oven is in operation.**
- **Do not let power cord hang over edge of table or counter.**
- **Do not operate this appliance if it has a damaged power cord or plug, if it is not working properly or if it has been damaged or dropped. If the power cord is damaged, it must be replaced by General Electric Service or an authorized service agent using a power cord available from General Electric.**
- **See door surface cleaning instructions** in the Care and Cleaning section(s) of this manual.
- **This appliance must only be serviced by qualified service personnel.** Contact nearest authorized service facility for examination, repair or adjustment.
- **As with any appliance, close supervision is necessary when used by children.**
- **To reduce the risk of fire in the oven cavity:**
 - **Do not overcook food.** Carefully attend appliance when paper, plastic or other combustible materials are placed inside the oven to facilitate cooking.
 - **Remove wire twist-ties and metal handles** from paper or plastic containers before placing them in the oven.
 - **Do not use the oven for storage purposes.** Do not leave paper products, cooking utensils or food in the oven when not in use.
 - **If materials inside oven ignite,** keep oven door closed, turn oven off and disconnect power cord, or shut off power at the fuse or circuit breaker panel. If the door is opened, the fire may spread.
 - **Do not use the Sensor Features twice** in succession on the same food portion. If food is undercooked after the first countdown, use **Time Cook** for additional cooking time.

ARCING

If you see arcing, press the **CLEAR/OFF** pad and correct the problem.

Arcing is the microwave term for sparks in the oven. Arcing is caused by:

- **Metal or foil touching the side of the oven.**
- **Foil not molded to food (upturned edges act like antennas).**

- **Metal, such as twist-ties, poultry pins or gold-rimmed dishes in the microwave.**
- **Recycled paper towels containing small metal pieces being used in the microwave.**

FOODS

- **Operating the microwave with no food inside for more than a minute or two may cause damage to the oven and could start a fire.**

It increases the heat around the magnetron and can shorten the life of the oven.

- **Hot foods and steam can cause burns.**
Be careful when opening any containers of hot food, including popcorn bags, cooking pouches and boxes. To prevent possible injury, direct steam away from hands and face.
- **Foods with unbroken outer “skin”** such as potatoes, sausages, tomatoes, apples, chicken livers and other giblets and egg yolks should be pierced to allow steam to escape during cooking.
- **Do not overcook potatoes.** They could dehydrate and catch fire, causing damage to your oven.
- **Some products such as whole eggs and sealed containers**—for example, closed jars—are able to explode and should not be heated in this microwave oven. Such use of the microwave oven could result in injury.
- **Do not boil eggs in a microwave oven.**
Pressure will build up inside egg yolk and will cause it to burst, possibly resulting in injury.
- **Avoid heating baby food** in glass jars, even with the lid off. Make sure all infant food is thoroughly cooked. Stir food to distribute the heat evenly. Be careful to prevent scalding when warming formula. The container may feel cooler than the formula really is. Always test the formula before feeding the baby.
- **Do not defrost frozen beverages in narrow-necked bottles** (especially carbonated beverages). Even if the container is opened, pressure can build up. This can cause the container to burst, possibly resulting in injury.

SAFETY FACT—Superheated water.

Liquids, such as water, coffee or tea, are able to be overheated beyond the boiling point without appearing to be boiling. Visible bubbling or boiling when the container is removed from the microwave oven is not always present. **THIS COULD RESULT IN VERY HOT LIQUIDS SUDDENLY BOILING OVER WHEN THE CONTAINER IS DISTURBED OR A SPOON OR OTHER UTENSIL IS INSERTED INTO THE LIQUID.**

To reduce the risk of injury to persons:

- Do not overheat the liquid.
 - Stir the liquid both before and halfway through heating it.
 - Do not use straight-sided containers with narrow necks.
 - After heating, allow the container to stand in the microwave oven for a short time before removing the container.
 - Use extreme care when inserting a spoon or other utensil into the container.
- **Cook meat and poultry thoroughly**—meat to at least an INTERNAL temperature of 160°F and poultry to at least an INTERNAL temperature of 180°F. Cooking to these temperatures usually protects against foodborne illness.
 - **Do not pop popcorn in your microwave oven** unless it is in a special microwave popcorn accessory or unless you use popcorn labeled for use in microwave ovens.

IMPORTANT SAFETY INSTRUCTIONS

MICROWAVE-SAFE COOKWARE

Make sure all cookware used in your microwave oven is suitable for microwaving. Most glass casseroles, cooking dishes, measuring cups, custard cups, pottery or china dinnerware which does not have metallic trim or glaze with a metallic sheen can be used. Some cookware is labeled "suitable for microwaving."

- If you are not sure if a dish is microwave-safe, use this test: Place in the oven both the dish you are testing and a glass measuring cup filled with one cup of water—set the measuring cup either in or next to the dish. Microwave 1 minute at high. If the dish heats, it should not be used for microwaving.

If the dish remains cool and only the water in the cup heats, then the dish is microwave-safe.

- If you use a meat thermometer while cooking, make sure it is safe for use in microwave ovens.
- **Do not use recycled paper products.** Recycled paper towels, napkins and waxed paper can contain metal flecks which may cause arcing or ignite. Paper products containing nylon or nylon filaments should be avoided, as they may also ignite.
- Some styrofoam trays (like those that meat is packaged on) have a thin strip of metal embedded in the bottom. When microwaved, the metal can burn the floor of the oven or ignite a paper towel.
- **Do not use the microwave oven to dry newspapers.**
- **Paper towels, waxed paper and plastic wrap can be used to cover dishes in order to retain moisture and prevent spattering. Be sure to vent plastic wrap so steam can escape.**
- **Not all plastic wrap is suitable for use in microwave ovens. Check the package for proper use.**

- **Cookware may become hot because of heat transferred from the heated food.** Pot holders may be needed to handle the cookware.

- "Boilable" cooking pouches and tightly closed plastic bags should be slit, pierced or vented as directed by package. If they are not, plastic could burst during or immediately after cooking, possibly resulting in injury. Also, plastic storage containers should be at least partially uncovered because they form a tight seal. When cooking with containers tightly covered with plastic wrap, remove covering carefully and direct steam away from hands and face.

- **Use foil only as directed in this guide.**

TV dinners may be microwaved in foil trays less than 3/4" high; remove the top foil cover and return the tray to the box. When using foil in the microwave oven, keep the foil at least 1" away from the sides of the oven.

- **Plastic cookware**—Plastic cookware designed for microwave cooking is very useful, but should be used carefully. Even microwave-safe plastic may not be as tolerant of overcooking conditions as are glass or ceramic materials and may soften or char if subjected to short periods of overcooking. In longer exposures to overcooking, the food and cookware could ignite.

Follow these guidelines:

1. Use microwave-safe plastics only and use them in strict compliance with the cookware manufacturer's recommendations.
2. Do not microwave empty containers.
3. Do not permit children to use plastic cookware without complete supervision.

GROUNDING INSTRUCTIONS

⚠ WARNING—Improper use of the grounding plug can result in a risk of electric shock.

This appliance must be grounded. In the event of an electrical short circuit, grounding reduces the risk of electric shock by providing an escape wire for the electric current.

This appliance is equipped with a power cord having a grounding wire with a grounding plug. The plug must be plugged into an outlet that is properly installed and grounded. (Fig. 1)

Fig. 1 PREFERRED METHOD

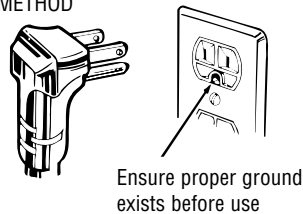

Consult a qualified electrician or service technician if the grounding instructions are not completely understood, or if doubt exists as to whether the appliance is properly grounded.

Where a standard 2-prong wall receptacle is encountered, it is your personal responsibility and obligation to have it replaced with a properly grounded 3-prong wall receptacle.

Do not under any circumstances cut or remove the third (ground) prong from the power cord.

We do not recommend using an extension cord with this appliance. If the power cord is too short, have a qualified electrician or service technician install an outlet near the appliance. (See the Extension Cords section.)

For best operation, plug this appliance into its own electrical outlet to prevent flickering of lights, blowing of fuse or tripping of circuit breaker.

USE OF ADAPTER PLUGS

Usage situations where appliance's power cord will be disconnected infrequently.

Because of potential safety hazards under certain conditions, **we strongly recommend against the use of an adapter plug.** However, if you still elect to use an adapter, where local codes permit, a TEMPORARY CONNECTION may be made to a properly grounded 2-prong wall receptacle by the use of a UL listed adapter (Fig. 2) which is available at most local hardware stores.

Fig. 2 TEMPORARY METHOD
(Adapter plugs not permitted in Canada)

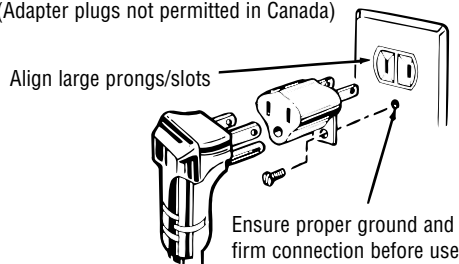

The larger slot in the adapter must be aligned with the larger slot in the wall receptacle to provide proper polarity in the connection of the power cord.

CAUTION: Attaching the adapter ground terminal to the wall receptacle cover screw does not ground the appliance unless the cover screw is metal, and not insulated, and the wall receptacle is grounded through the house wiring. You should have the circuit checked by a qualified electrician to make sure the receptacle is properly grounded.

When disconnecting the power cord from the adapter, always hold the adapter with one hand. If this is not done, the adapter ground terminal is very likely to break with repeated use. Should this happen, **DO NOT USE** the appliance until a proper ground has again been established.

Usage situations where appliance's power cord will be disconnected frequently.

Do not use an adapter plug in these situations because frequent disconnection of the power cord places undue strain on the adapter and leads to eventual failure of the adapter ground terminal. You should have the 2-prong wall receptacle replaced with a 3-prong (grounding) receptacle by a qualified electrician before using the appliance.

IMPORTANT SAFETY INSTRUCTIONS

USE OF EXTENSION CORDS

A short power supply cord is provided to reduce the risks resulting from becoming entangled in or tripping over a longer cord.

Extension cords may be used if you are careful in using them.

If an extension cord is used—

1. The marked electrical rating of the cord set or extension cord should be at least as great as the electrical rating of the appliance.
2. The extension cord must be a grounding-type 3-wire cord and it must be plugged into a 3-slot outlet.

3. The longer cord should be arranged so that it will not drape over the countertop or tabletop where it can be pulled on by children or tripped over unintentionally.

If you use an extension cord, the interior light may flicker and the blower sound may vary when the microwave oven is on. Cooking times may be longer, too.

SAVE THESE INSTRUCTIONS

Features of Your Oven

Countertop Microwave Oven

Throughout this manual, features and appearance may vary from your model

800 watts

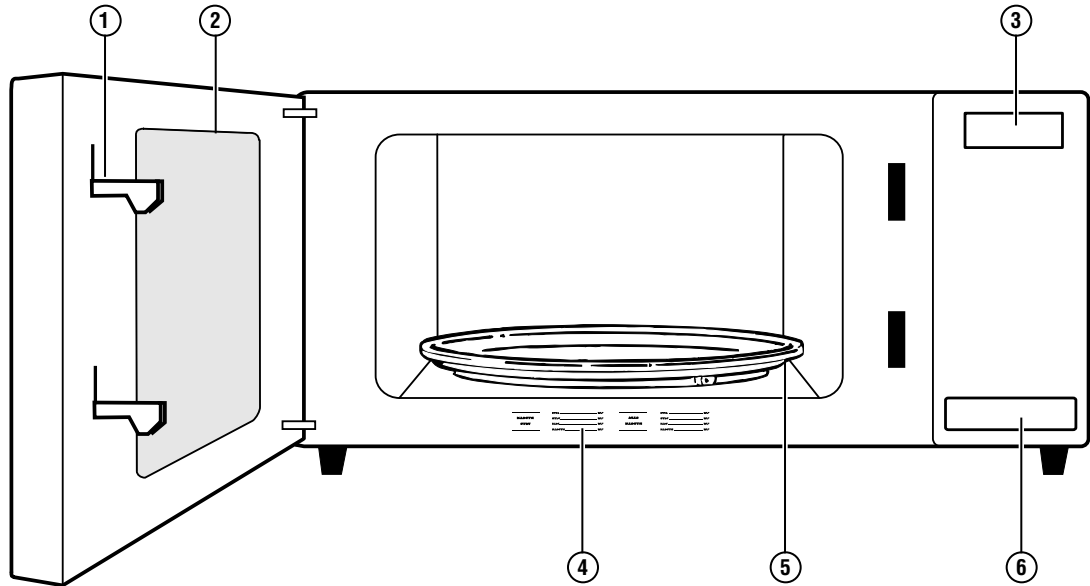

1. Door Latches.

2. Window with Metal Shield. Screen allows cooking to be viewed while keeping microwaves confined in the oven.

3. Touch Control Panel and Display.

4. Convenience Guide.

5. Removable Turntable. Turntable and support *must* be in place when using the oven. The turntable may be removed for cleaning.

6. Door Latch Release. Press latch release button to open door.

NOTE: Rating plate, oven vent(s) and oven light are located on the inside walls of the microwave oven.

Accessory Included

The enclosed hardware kit (4-A019) allows you to hang this model under your cabinet.

Optional Accessories

Available at extra cost from your GE supplier.

JX827 27" Built-In Kit allows this oven to be built into a cabinet or wall.

You can microwave by time, with the sensor features or with the auto feature

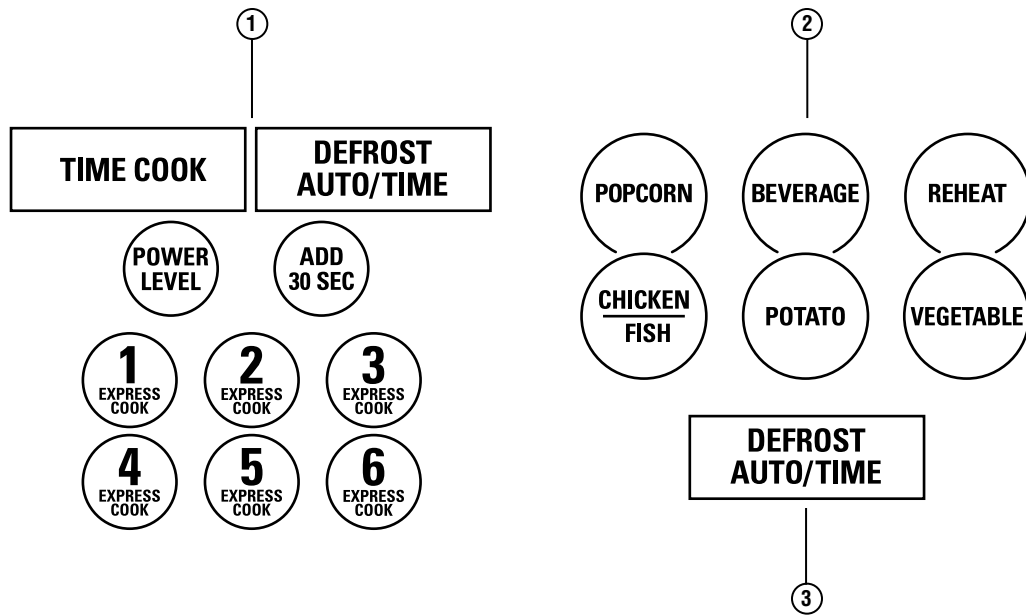

Check the Convenience Guide before you begin.

1. Time Features

Press	Enter
TIME COOK Press once or twice	Amount of cooking time
DEFROST AUTO/TIME Press twice	Amount of defrosting time
EXPRESS COOK	Starts immediately!
ADD 30 SEC	Starts immediately!
POWER LEVEL	Power level 1–10

2. Sensor Features

Press	Enter	Option
POPCORN	Starts immediately!	more/less time
BEVERAGE	Starts immediately!	
REHEAT	Starts immediately!	more/less time
CHICKEN/FISH Press once (chicken pieces) Press twice (fish fillets)	Starts immediately!	more/less time
POTATO	Starts immediately!	more/less time
VEGETABLE Press once (fresh vegetables) Press twice (frozen vegetables) Press three times (canned vegetables)	Starts immediately!	more/less time

3. Auto Feature

Press	Enter
DEFROST AUTO/TIME Press once	Food weight

Variable Power Levels 1–10

How to Change Power Level

The power level may be entered or changed immediately after entering the feature time for Time Cook, Defrost or Express Cook. The power level may also be changed during time countdown.

1. Press TIME COOK or select Time Defrost.
2. Select cooking or defrosting time.
3. Press POWER LEVEL.
4. Select desired power level 1–10.
5. Press START.

Variable power levels add flexibility to your microwave cooking. The power levels on your microwave oven can be compared to the surface units on a range. Each power level gives you microwave energy a certain percent of the time. Power level 7 is microwave energy 70% of the time. Power level 3 is energy 30% of the time. Most cooking will be done on High (power level 10) which gives you 100% power.

Power level 10 will cook faster but food may need more frequent stirring, rotating or turning over. A lower setting will cook more evenly and need less stirring or rotating of the food.

Some foods may have better flavor, texture or appearance if one of the lower settings is used. Use a lower power level when cooking foods that have a tendency to boil over, such as scalloped potatoes.

Rest periods (when the microwave energy cycles off) give time for the food to “equalize” or transfer heat to the inside of the food. An example of this is shown with power level 3—the defrost cycle. If microwave energy did not cycle off, the outside of the food would cook before the inside was defrosted.

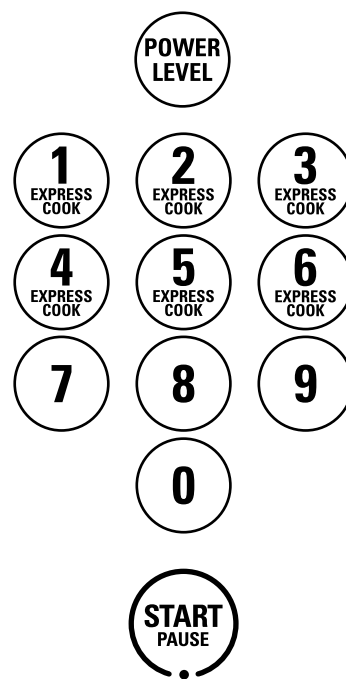

Here are some examples of uses for various power levels:

POWER LEVEL	BEST USES
High 10	Fish, bacon, vegetables, boiling liquids.
Med-High 7	Gentle cooking of meat and poultry; baking casseroles and reheating.
Medium 5	Slow cooking and tenderizing such as stews and less tender cuts of meat.
Low 3	Defrosting without cooking; simmering; delicate sauces.
Warm 1	Keeping food warm without overcooking; softening butter.

Time Cook

Time Cook I

Allows you to microwave for any time up to 99 minutes and 99 seconds.

Power level 10 (high) is automatically set, but you may change it for more flexibility.

1. Press TIME COOK.
2. Enter cooking time.
3. Change power level if you don't want full power. (Press POWER LEVEL. Select a desired power level 1–10.)
4. Press START.

You may open the door during Time Cook to check the food. Close the door and press START to resume cooking.

Time Cook II

Lets you change power levels automatically during cooking. Here's how to do it:

1. Press TIME COOK.
2. Enter the first cook time.
3. Change the power level if you don't want full power. (Press POWER LEVEL. Select a desired power level 1–10.)
4. Press TIME COOK again.
5. Enter the second cook time.
6. Change the power level if you don't want full power. (Press POWER LEVEL. Select a desired power level 1–10.)
7. Press START.

At the end of Time Cook I, Time Cook II counts down.

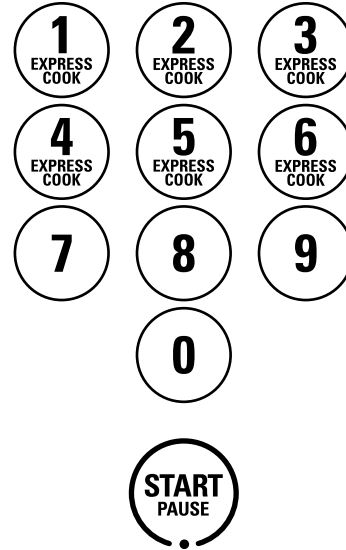

Cooking Guide for Time Cook

NOTE: Use power level 10 (High) unless otherwise noted.

Vegetable	Amount	Time	Comments
Asparagus (fresh spears)	1 lb.	7 to 10 min., Med-High (7)	In 1½-qt. oblong glass baking dish, place 1/4 cup water. Rotate dish after half of time.
(frozen spears)	10-oz. package	5 to 8 min.	In 1-qt. casserole.
Beans (fresh green)	1 lb. cut in half	12 to 17 min.	In 1½-qt. casserole, place 1/2 cup water.
(frozen green)	10-oz. package	5 to 9 min.	In 1-qt. casserole, place 2 tablespoons water.
(frozen lima)	10-oz. package	5 to 9 min.	In 1-qt. casserole, place 1/4 cup water.
Beets (fresh, whole)	1 bunch	18 to 25 min.	In 2-qt. casserole, place 1/2 cup water.
Broccoli (fresh cut)	1 bunch (1¼ to 1½ lbs.)	7 to 10 min.	In 2-qt. casserole, place 1/2 cup water.
(fresh spears)	1 bunch (1¼ to 1½ lbs.)	9 to 13 min.	In 2-qt. oblong glass baking dish, place 1/4 cup water. Rotate dish after half of time.
(frozen, chopped)	10-oz. package	5 to 8 min.	In 1-qt. casserole.
(frozen spears)	10-oz. package	5 to 8 min.	In 1-qt. casserole, place 3 tablespoons water.
Cabbage (fresh) (wedges)	1 medium head (about 2 lbs.)	8 to 11 min. 7 to 10 min.	In 1½- or 2-qt. casserole, place 1/4 cup water. In 2- or 3-qt. casserole, place 1/4 cup water.
Carrots (fresh, sliced)	1 lb.	6 to 9 min.	In 1½-qt. casserole, place 1/4 cup water.
(frozen)	10-oz. package	5 to 8 min.	In 1-qt. casserole, place 2 tablespoons water.
Cauliflower (flowerets)	1 medium head	9 to 14 min.	In 2-qt. casserole, place 1/2 cup water.
(fresh, whole)	1 medium head	9 to 17 min.	In 2-qt. casserole, place 1/2 cup water.
(frozen)	10-oz. package	5 to 8 min.	In 1-qt. casserole, place 2 tablespoons water.
Corn (frozen kernel)	10-oz. package	4 to 8 min.	In 1-qt. casserole, place 2 tablespoons water.
Corn on the cob (fresh)	1 to 5 ears	3 to 5 min. per ear	In 2-qt. oblong glass baking dish, place corn. If corn is in husk, use no water; if corn has been husked, add 1/4 cup water. Rearrange after half of time.
(frozen)	1 ear 2 to 6 ears	5 to 7 min. 2 to 4 min. per ear	Place in 2-qt. oblong glass baking dish. Cover with vented plastic wrap. Rearrange after half of time.
Mixed vegetables (frozen)	10-oz. package	4 to 8 min.	In 1-qt. casserole, place 3 tablespoons water.
Peas (fresh, shelled)	2 lbs. unshelled	9 to 12 min.	In 1-qt. casserole, place 1/4 cup water.
(frozen)	10-oz. package	4 to 8 min.	In 1-qt. casserole, place 2 tablespoons water.
Potatoes (fresh, cubed, white)	4 potatoes (6 to 8 oz. each)	11 to 14 min.	Peel and cut into 1 inch cubes. Place in 2-qt. casserole with 1/2 cup water. Stir after half of time.
(fresh, whole, sweet or white)	1 (6 to 8 oz.)	2 to 5 min.	Pierce with cooking fork. Place in the oven, 1 inch apart, in circular arrangement. Let stand 5 minutes.
Spinach (fresh)	10 to 16 oz.	5 to 8 min.	In 2-qt. casserole, place washed spinach.
(frozen, chopped and leaf)	10-oz. package	5 to 8 min.	In 1-qt. casserole, place 3 tablespoons water.
Squash (fresh, summer and yellow)	1 lb. sliced	4 to 7 min.	In 1½-qt. casserole, place 1/4 cup water.
(winter, acorn or butternut)	1 to 2 squash (about 1 lb. each)	7 to 11 min.	Cut in half and remove fibrous membranes. In 2-qt. oblong glass baking dish, place squash cut-side-down. Turn cut-side-up after 4 minutes.

*Time
Defrost*

Allows you to defrost for a selected length of time. See the Defrosting Guide for suggested times. (Auto Defrost is explained in the Auto Feature section.)

1. Press DEFROST AUTO/TIME twice.
2. Enter defrosting time.
3. Press START.
4. Turn food over when the oven signals.
5. Press START.

Power level is automatically set at 3, but can be changed. You can defrost small items quickly by raising the power level after entering the time. Power level 7 cuts the total defrosting time in about half; power level 10 cuts the total time to approximately 1/3. However, food will need more frequent attention than usual.

At one half of selected defrosting time, the oven signals "TURN." At this time, turn food over and break apart or rearrange pieces for more even defrosting. Shield any warm areas with small pieces of foil. The oven will continue to defrost if you don't open the door and turn the food.

A dull thumping noise may be heard during defrosting. This is normal when oven is not operating at High power.

Defrosting Tips

- Foods frozen in paper or plastic can be defrosted in the package. Closed packages should be slit, pierced or vented AFTER food has partially defrosted. Plastic storage containers should be partially uncovered.
- Family-size, prepackaged frozen dinners can be defrosted and microwaved. If the food is in a foil container, transfer it to a microwave-safe dish.

**DEFROST
AUTO/TIME**

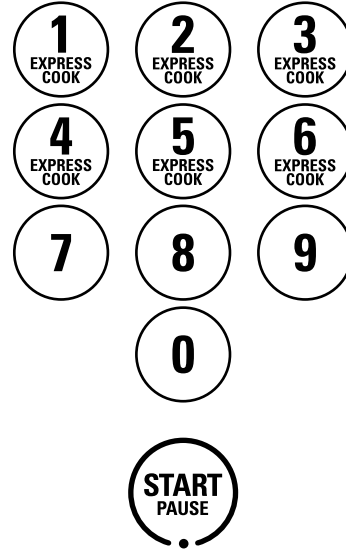

- For more even defrosting of larger foods, such as roasts, use Auto Defrost. Be sure large meats are completely defrosted before cooking.
- Foods that spoil easily should not be allowed to sit out for more than one hour after defrosting. Room temperature promotes the growth of harmful bacteria.
- When defrosted, food should be cool but softened in all areas. If still slightly icy, return to the microwave very briefly, or let it stand a few minutes.

Defrosting Guide

Food	Time	Comments
Breads, Cakes Bread, buns or rolls (1 piece) Sweet rolls (approx. 12 oz.)	1/2 min. 2 to 4 min.	Rearrange after half of time.
Fish and Seafood Fillets, frozen (1 lb.) Shellfish, small pieces (1 lb.)	8 to 12 min. 5 to 8 min.	Place block in casserole. Turn over and break up after first half of time.
Fruit Plastic pouch —1 or 2 (10-oz. package)	3 to 7 min.	
Meat Bacon (1 lb.) Franks (1 lb.) Ground meat (1 lb.) Roast: beef, lamb, veal, pork Steaks, chops and cutlets	3 to 6 min. 3 to 6 min. 5 to 8 min. 10 to 16 min. per lb. 5 to 10 min. per lb.	Place unopened package in oven. Let stand 5 minutes after defrosting. Place unopened package in oven. Microwave just until franks can be separated. Let stand 5 minutes, if necessary, to complete defrosting. Turn meat over after first half of time. Use power level Warm (1). Place unwrapped meat in cooking dish. Turn over after first half of time and shield warm areas with foil. After second half of time, separate pieces with table knife. Let stand to complete defrosting.
Poultry Chicken, broiler-fryer, cut up (2½ to 3 lbs.) Chicken, whole (2½ to 3 lbs.) Cornish hen Turkey breast (4 to 6 lbs.)	16 to 22 min. 22 to 28 min. 9 to 16 min. per lb. 5 to 10 min. per lb.	Place wrapped chicken in dish. Unwrap and turn over after first half of time. After second half of time, separate pieces and place in cooking dish. Microwave 2–4 minutes more, if necessary. Let stand a few minutes to finish defrosting. Place wrapped chicken in dish. After first half of time, unwrap and turn chicken over. Shield warm areas with foil. To complete defrosting, run cool water in cavity until giblets can be removed. Place unwrapped hen in oven breast-side-up. Turn over after first half of time. Run cool water in cavity until giblets can be removed. Place unwrapped breast in microwave-safe dish breast-side-down. After first half of time, turn breast-side-up and shield warm areas with foil. Defrost for second half of time. Let stand 1–2 hours in refrigerator to complete defrosting.

Express Cook

This is a quick way to set cooking time for 1–6 minutes.

Press one of the Express Cook pads (from 1 to 6) for 1 to 6 minutes of cooking at power level 10. For example, press the 2 pad for 2 minutes of cooking time.

The power level can be changed as time is counting down. Press POWER LEVEL and enter 1–10.



Add 30 Seconds

You can use this feature two ways:

- It will add 30 seconds to the time counting down each time the pad is touched.
- It can be used as a quick way to set 30 seconds of cooking time.



Auto Defrost

The Defrost Auto/Time feature gives you two ways to defrost frozen foods. Press DEFROST AUTO/TIME once for Auto Defrost or twice for Time Defrost.

Use Auto Defrost for meat, poultry and fish. Use Time Defrost for most other frozen foods.

Auto Defrost automatically sets the defrosting times and power levels to give even defrosting results for meats, poultry and fish.

1. Press DEFROST AUTO/TIME once.
2. Using the conversion guide below, enter food weight. For example, press pads 1 and 2 for 1.2 pounds (1 pound, 3 ounces).
3. Press START.

(Time Defrost is explained in the Time Features section.)

There is a handy guide located on the inside front of the oven.

- Remove meat from package and place on microwave-safe dish.
- Twice during defrost, the oven signals "TURN." At each "TURN" signal, turn the food over. Remove defrosted meat or shield warm areas with small pieces of foil.
- After defrosting, most meats need to stand 5 minutes to complete defrosting. Large roasts should stand for about 30 minutes.

Conversion Guide

If the weight of food is stated in pounds and ounces, the ounces must be converted to tenths (.1) of a pound.	
Ounces	Pounds
1-2	.1
3	.2
4-5	.3
6-7	.4
8	.5
9-10	.6
11	.7
12-13	.8
14-15	.9

DEFROST AUTO/TIME

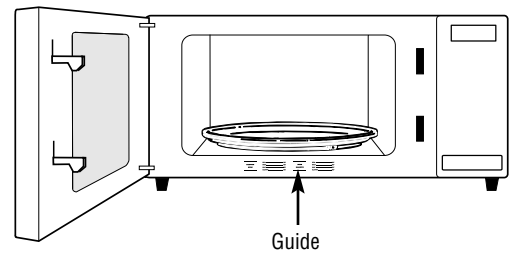
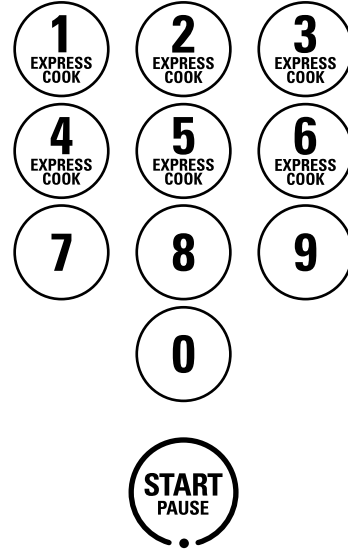

Humidity Sensor

The Sensor Features detect the increasing humidity released during cooking. The oven automatically adjusts the cooking time to various types and amounts of food.

Do not use the Sensor Features twice in succession on the same food portion—it may result in severely overcooked or burnt food. If food is undercooked after the countdown, use TIME COOK for additional cooking time.

- The proper containers and covers are essential for best sensor cooking.
- **Always use microwave-safe containers and cover them with lids or vented plastic wrap. Never use tight-sealing plastic covers**—they can prevent steam from escaping and cause food to overcook.
- **Be sure the outside of the cooking container and the inside of the microwave oven are dry** before placing food in the oven. Beads of moisture turning into steam can mislead the sensor.

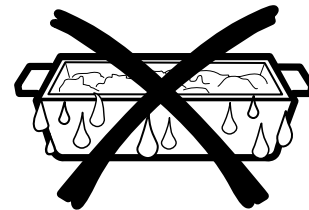
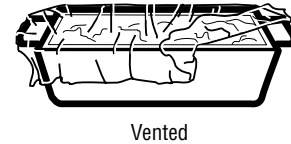
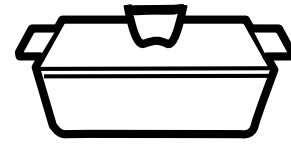

Dry off dishes so they don't mislead the sensor.

Popcorn

NOTE: Do not use this feature twice in succession on the same food portion—it may result in severely overcooked or burnt food.

To use the Popcorn feature:

1. Follow package instructions, using Micro Cook if the package is less than 3.0 ounces or larger than 3.5 ounces. Place the package of popcorn in the center of the microwave.
2. Press POPCORN. The oven starts immediately.

If you open the door while “POPCORN” is displayed, “SENSOR ERROR” will appear. Close the door, press CLEAR/OFF and begin again.

If food is undercooked after the countdown use TIME COOK for additional cooking time.

During the Popcorn cycle, the turntable will rotate, stop, then rotate again. This feature provides optimum results.

How to Adjust the Popcorn Program to Provide a Shorter or Longer Cook Time

If you find that the brand of popcorn you use underpops or overcooks consistently, you can add or subtract 20–30 seconds to the automatic popping time.

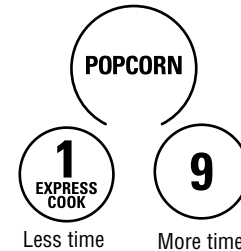

To add time:

After pressing POPCORN, press 9 immediately after the oven starts for an extra 20 seconds. Press 9 again to add another 10 seconds (total 30 seconds additional time).

To subtract time:

After pressing POPCORN, press 1 immediately after the oven starts for 20 seconds less cooking time. Press 1 again to reduce cooking time another 10 seconds (total 30 seconds less time).

Beverage

NOTE: Do not use this feature twice in succession on the same food portion—it may result in severely overcooked or burnt food.

Press BEVERAGE to heat a cup of coffee or other beverage.

Drinks heated with the Beverage feature may be very hot. Remove the container with care.

If food is undercooked after the countdown use TIME COOK for additional cooking time.



How to Change the Automatic Settings

You can adjust the cooking time for the following features to suit your personal taste.

To reduce time by 10%:

Press 1 after the feature pad.

To add 10% to cooking time:

Press 9 after the feature pad.

Reheat

NOTE: Do not use this feature twice in succession on the same food portion—it may result in severely overcooked or burnt food.

The Reheat feature reheats single servings of previously cooked foods or a plate of leftovers.

1. Place covered food in the oven. Press REHEAT. The oven starts immediately.
2. The oven signals when steam is sensed and the time remaining begins counting down.

Do not open the oven door until time is counting down. If the door is opened, close it and press START immediately.

After removing food from the oven, stir, if possible, to even out the temperature. Reheated foods may have wide variations in temperature. Some areas may be extremely hot.

If food is not hot enough after the countdown use TIME COOK for additional reheating time.



Some Foods Not Recommended for Use With Reheat

It is best to use Time Cook for these foods:

- Bread products.
 - Foods that must be reheated uncovered.
 - Foods that need to be stirred or rotated.
 - Foods calling for a dry look or crisp surface after reheating.
-

Chicken/Fish

NOTE: Do not use this feature twice in succession on the same food portion—it may result in severely overcooked or burnt food.

Use the Chicken/Fish feature to cook 1–8 pieces of chicken or 4–16 ounces of fish.

1. Place covered chicken or fish in the oven. Press CHICKEN/FISH once for chicken pieces or twice for fish. The oven starts immediately.
2. The oven signals when steam is sensed and the time remaining begins counting down.



Do not open the oven door until time is counting down. If the door is opened, close it and press START immediately. If food is undercooked after the countdown use TIME COOK for additional cooking time.

Potato

NOTE: Do not use this feature twice in succession on the same food portion—it may result in severely overcooked or burnt food.

The Potato feature cooks 1/2–2 lbs. of potatoes.

1. Pierce skin with fork and place potatoes on the turntable. If cooking three or more potatoes, arrange in a star pattern.
2. Press POTATO. The oven starts immediately. The oven signals when steam is sensed and the time remaining begins counting down.

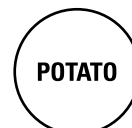

Do not open the oven door until time is counting down. If the door is opened, close it and press START immediately. If food is undercooked after the countdown use TIME COOK for additional cooking time.

Vegetable

NOTE: Do not use this feature twice in succession on the same food portion—it may result in severely overcooked or burnt food.

Use the Vegetable feature to cook 4–16 ounces of fresh, frozen or canned vegetables.

1. For fresh vegetables, add 2 tablespoons of water per serving. For frozen vegetables, follow package instructions for adding water. Cover with lid or plastic wrap. Place vegetables in the oven.
2. Press VEGETABLE once for fresh vegetables, twice for frozen vegetables or three times for canned vegetables. The oven starts immediately. The oven signals when steam is sensed and time remaining is counting down.

For fresh and frozen vegetable features only, you can adjust the automatic setting (on some

*Child
Lock-Out*

You may lock the control panel to prevent the microwave from being accidentally started or used by children.

To the control lock the controls, press and hold CLEAR/OFF for 3 seconds. When the microwave is locked, the display shows "L" and the microwave will not operate. To unlock the microwave, press and hold CLEAR/OFF for 3 seconds. When the microwave is unlocked, the display shows "0" and the microwave will operate normally.

Reminder

The Reminder feature can be used like an alarm clock, and can be used at any time, even when the oven is operating. The Reminder time can be set up to 24 hours later.

REMINDER

1. Press REMINDER.
2. Enter the time you want the oven to remind you. (Be sure the microwave clock shows the correct time of day.)
3. Select AM or PM.
4. Press REMINDER. When Reminder signal occurs, press REMINDER to turn it off. The Reminder time may be displayed by pressing REMINDER.

NOTE: The “REM” indicator will remain lit to show that the Reminder is set. To clear the Reminder before it occurs, press REMINDER, then 0. The “REM” indicator will no longer be lit.

Delay Start

Delay Start allows you to set the microwave to delay cooking up to 24 hours.

DELAY
START

1. Press DELAY START.
2. Enter the time you want the oven to start. (Be sure the microwave clock shows the correct time of day.)
3. Select AM or PM.
4. Select any combination of Defrost Auto/Time and Time Cook.
5. Press START.

The Delay Start time will be displayed plus “DS.” The oven will automatically start at the delayed time.

The time of day may be displayed by pressing CLOCK.

Timer On/Off

Timer On/Off operates as a minute timer and can be used at any time, even when the oven is operating.

TIMER
ON/OFF

1. Press TIMER ON/OFF.
2. Enter time you want to count down.
3. Press TIMER ON/OFF to start.

When time is up, the oven will signal. To turn off the timer signal, press TIMER ON/OFF.

NOTE: The timer indicator will be lit while the timer is operating.

Turntable

For best cooking results, leave the turntable on. It can be turned off for large dishes. Press TURNTABLE to turn the turntable on or off.

TURNTABLE
ON/OFF

Sometimes the turntable can become too hot to touch. Be careful touching the turntable during and after cooking.

Microwave Terms

Countertop Microwave Oven

Arcing

Arcing is the microwave term for sparks in the oven. Arcing is caused by:

- Metal or foil touching the side of the oven.
- Foil that is not molded to food (upturned edges act like antennas).

- Metal such as twist-ties, poultry pins, gold-rimmed dishes.

- Recycled paper towels containing small metal pieces.
-

Covering

Covers hold in moisture, allow for more even heating and reduce cooking time.

Venting plastic wrap or covering with wax paper allows excess steam to escape.

Shielding

In a regular oven, you shield chicken breasts or baked foods to prevent over-browning. When microwaving, you use small strips of foil to shield thin parts, such as the tips of wings and legs on poultry, which would cook before larger parts.

Standing Time

When you cook with regular ovens, foods such as roasts or cakes are allowed to stand to finish cooking or to set.

Standing time is especially important in microwave cooking. Note that a microwaved cake is not placed on a cooling rack.

Venting

After covering a dish with plastic wrap, you vent the plastic wrap by turning back one corner so excess steam can escape.

An occasional thorough wiping with a solution of baking soda and water keeps the inside fresh.

UNPLUG THE CORD BEFORE CLEANING ANY PART OF THIS OVEN.



How to Clean the Inside

Walls, Floor, Inside Window, Mode Stirrer Cover and Metal and Plastic Parts on the Door.

Some spatters can be removed with a paper towel, others may require a damp cloth. Remove greasy spatters with a sudsy cloth, then rinse with a damp cloth. Do not use abrasive cleaners on oven walls. **NEVER USE A COMMERCIAL OVEN CLEANER ON ANY PART OF YOUR MICROWAVE OVEN.**

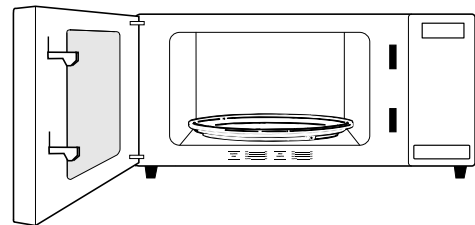

Removable Turntable and Turntable Support.

To prevent breakage, do not place the turntable into water just after cooking. Wash it carefully in warm, sudsy water or in the dishwasher. The turntable and support can be broken if dropped. Remember, do not operate the oven without the turntable and support in place.

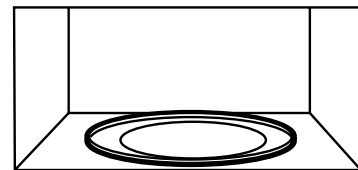

How to Clean the Outside

Do not use cleaners containing ammonia or alcohol on the microwave oven. Ammonia or alcohol can damage the appearance of the microwave.

Case. Clean the outside of the microwave with a sudsy cloth. Wipe the window clean with a damp cloth.

Control Panel and Door. Wipe with a damp cloth. Dry thoroughly. Do not use cleaning sprays, large amounts of soap and water, abrasives or sharp objects on the panel—they can damage it. Some paper towels can also scratch the control panel.

Door Surface. It's important to keep the area clean where the door seals against the microwave. Use only mild, non-abrasive soaps or detergents applied with a sponge or soft cloth. Rinse well.

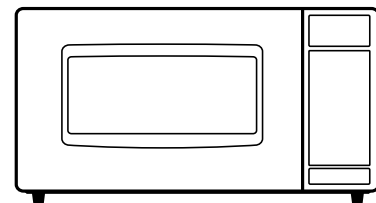

Stainless Steel. *Do not use a steel-wood pad; it will scratch the surface.* To clean the stainless steel surface, use a hot, damp cloth with a mild detergent suitable for stainless steel surfaces. Use a clean, hot, damp cloth to remove soap. Dry with a dry, clean cloth. Always scrub lightly in the direction of the grain.

*Questions?
Use this
problem
solver*

PROBLEM	POSSIBLE CAUSE
OVEN WILL NOT COME ON	<ul style="list-style-type: none"> • A fuse in your home may be blown or the circuit breaker tripped. Replace fuse or reset circuit breaker. • Unplug your microwave oven, then plug it back in. • Make sure 3-prong plug on oven is fully inserted into wall receptacle.
CONTROL PANEL LIGHTED, YET OVEN WILL NOT START	<ul style="list-style-type: none"> • Door not securely closed. • START must be pressed after entering cooking selection. • Another selection entered already in oven and CLEAR/OFF not pressed to cancel it. • Make sure you have entered cooking time after pressing TIME COOK. • CLEAR/OFF was pressed accidentally. Reset cooking program and press START. • Make sure you entered food weight after pressing AUTO DEFROST.
“SENSOR ERROR” APPEARS ON DISPLAY	<ul style="list-style-type: none"> • During Popcorn, Beverage, Reheat, Chicken/Fish, Potato or Vegetable program, the door was opened before steam could be detected. Close the door, press CLEAR/OFF and begin again. • Steam was not detected in maximum time. Use Time Cook to heat for more time.
“LOCKED” APPEARS ON DISPLAY	<ul style="list-style-type: none"> • The control panel has been locked. (When the control panel is locked an “L” will be displayed.) Press and hold CLEAR/OFF for about 3 seconds to unlock the control panel.
FOOD AMOUNT TOO LARGE FOR SENSOR REHEAT	<ul style="list-style-type: none"> • Sensor Reheat is for single servings of recommended foods. Use Time Cook for large amounts of food.

All these things are normal with your microwave oven:

- Steam or vapor escaping from around the door.
- Light reflection around door or outer case.
- Dimming oven light and change in blower sound may occur while operating at power levels other than high.
- Dull thumping sound while oven is operating.
- Turntable starts and stops automatically during Popcorn.
- Some TV/radio interference might be noticed while using your microwave oven. It's similar to the interference caused by other small appliances and does not indicate a problem with your oven. Plug the microwave into a different electrical circuit, move the radio or TV as far away from the microwave as possible or check the position and signal of the TV/radio antenna.

Consumer Product Ownership Registration Important Mail Today

GE Appliances

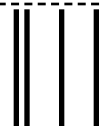

Place
1st Class
Letter
Stamp
Here

General Electric Company
Warranty Registration Department
P.O. Box 34070
Louisville, KY 40232-2150

Consumer Product Ownership Registration

Dear Customer:

Thank you for purchasing our product and thank you for placing your confidence in us. We are proud to have you as a customer!

Follow these three steps to protect your new appliance investment:

1

Complete and mail your Consumer Product Ownership Registration today. Have the peace of mind of knowing we can contact you in the unlikely event of a safety modification.

2

After completing this registration, write your model and serial numbers in this manual. You will need this information should you require service. Our service number is 800.444.1845.

3

Read your Owner's Manual carefully. It will help you operate your new appliance properly.

Important: To ensure that your product is registered, mail the separate product registration card. If the separate product registration card is missing, fold and mail the form below. No envelope is needed.

Consumer Product Ownership Registration



Product
Microwave Oven

Model

Serial

Mr. Ms. Mrs. Miss

First Name _____ Last Name _____

Street Address _____

Apt. # _____

City _____ State _____ Zip Code _____

Date Placed
In Use Month _____ Day _____ Year _____ Phone Number _____-_____-_____



Monogram[®] www.monogram.com

GE Consumer Products
General Electric Company
Louisville, KY 40225

* Please provide your e-mail address to receive, via e-mail, discounts, special offers and other important communications from GE Appliances (GEA).

Check here if you do not want to receive communications from GEA's carefully selected partners.

FAILURE TO COMPLETE AND RETURN THIS CARD DOES NOT DIMINISH YOUR WARRANTY RIGHTS.

For more information about GEA's privacy and data usage policy, go to www.GEAppliances.com and click on "Privacy Policy" or call 800.626.2224.

CUT HERE

With the purchase of your new Monogram appliance, receive the assurance that if you ever need information or assistance from GE, we'll be there. All you have to do is call—toll-free!

GE Answer Center®

800.626.2000

Whatever your question about any Monogram major appliance, GE Answer Center® information service is available to help. Your call—and your question—will be answered promptly and courteously. And you can call any time. GE Answer Center® service is open 24 hours a day, 7 days a week.

In-Home Repair Service

800.444.1845

A GE consumer service professional will provide expert repair service, scheduled at a time that's convenient for you. Many GE Consumer Service company-operated locations offer you service today or tomorrow, or at your convenience (7:00 a.m. to 7:00 p.m. weekdays, 9:00 a.m. to 2:00 p.m. Saturdays). Our factory-trained technicians know your appliance inside and out—so most repairs can be handled in just one visit.

For Customers With Special Needs...

800.626.2000

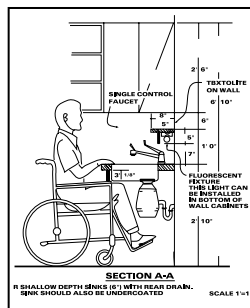

GE offers Braille controls for a variety of GE appliances, and a brochure to assist in planning a barrier-free kitchen for persons with limited mobility.

Consumers with impaired hearing or speech who have access to a TDD or a conventional teletypewriter may call 800.TDD.GEAC (800.833.4322) to request information or service.

Service Contracts

800.626.2224

You can have the secure feeling that GE Consumer Service will still be there after your warranty expires. Purchase a GE contract while your warranty is still in effect and you'll receive a substantial discount. With a multiple-year contract, you're assured of future service at today's prices.

Parts and Accessories

800.626.2002

Individuals qualified to service their own appliances can have parts or accessories sent directly to their home. The GE parts system provides access to over 47,000 parts...and all GE Genuine Renewal Parts are fully warranted. VISA, MasterCard and Discover cards are accepted.

User maintenance instructions contained in this manual cover procedures intended to be performed by any user. Other servicing generally should be referred to qualified service personnel. Caution must be exercised, since improper servicing may cause unsafe operation.

YOUR MONOGRAM MICROWAVE OVEN WARRANTY
Staple sales slip or cancelled check here. Proof of original purchase date is needed to obtain service under warranty.

WHAT IS COVERED

FULL ONE-YEAR WARRANTY

For one year from date of original purchase, we will provide, free of charge, parts and service labor in your home to repair or replace **any part of the microwave oven** that fails because of a manufacturing defect.

LIMITED ADDITIONAL NINE-YEAR WARRANTY

For the second through the tenth year from date of original purchase, we will provide, free of charge, a replacement **magnetron tube** if the magnetron tube fails because of a manufacturing defect. You pay for any service labor charges.

.....
This warranty is extended to the original purchaser and any succeeding owner for products purchased for ordinary home use in the 48 mainland states, Alaska, Hawaii and Washington, D.C.

All warranty service will be provided by our Factory Service Centers or by our authorized Customer Care® servicers during normal working hours.

Should your appliance need service, during warranty period or beyond, call 800.444.1845.

WHAT IS NOT COVERED

- Service trips to your home to teach you how to use the product.
 - Replacement of house fuses or resetting of circuit breakers.
 - Damage to product caused by accident, fire, floods or acts of God.
 - Failure of the product if it is used for other than its intended purpose or used commercially.
 - Damage caused after delivery.
 - Improper installation, delivery or maintenance.
- If you have an installation problem, contact your dealer or installer. You are responsible for providing adequate electrical, exhausting and other connecting facilities.
- Incidental or consequential damages caused by possible defects with this appliance.

Some states do not allow the exclusion or limitation of incidental or consequential damages, so the above limitation or exclusion may not apply to you. This warranty gives you specific legal rights, and you may also have other rights which vary from state to state.

To know what your legal rights are in your state, consult your local or state consumer affairs office or your state's Attorney General.

Warrantor: General Electric Company, Louisville, KY 40225



Monogram®
We bring good things to life.

General Electric Company
Louisville, KY 40225

164D3370P287

49-40357

06-03 JR

Printed in Malaysia

Free Manuals Download Website

<http://myh66.com>

<http://usermanuals.us>

<http://www.somanuals.com>

<http://www.4manuals.cc>

<http://www.manual-lib.com>

<http://www.404manual.com>

<http://www.luxmanual.com>

<http://aubethermostatmanual.com>

Golf course search by state

<http://golfingnear.com>

Email search by domain

<http://emailbydomain.com>

Auto manuals search

<http://auto.somanuals.com>

TV manuals search

<http://tv.somanuals.com>