

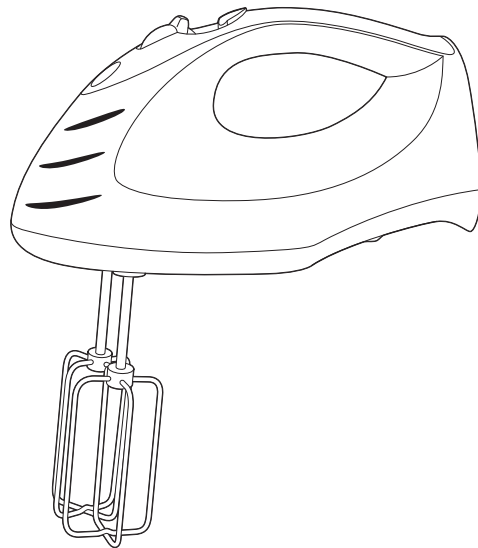

HAND MIXER BATTEUR À MAIN BATIDORA DE MANO



**READ BEFORE USE
LIRE AVANT L'UTILISATION
LEA ANTES DE USAR**

840146100

106651N

**For Customer Assistance, call Customer Service at
1-877-207-0923 (US) or 1-877-556-0973 (Canada)**

Pour l'assistance à la clientèle au Canada : 1-877-556-0973

**Para comunicarse con Asistencia al Cliente en México: 01-800-343-7378
Le invitamos a leer cuidadosamente este instructivo antes de usar su aparato.**

WARNING

Shock Hazard

- Do not immerse this appliance in water or other liquid.
- This appliance has a polarized plug (one wide blade) that reduces the risk of electrical shock. The plug fits only one way into a polarized outlet. Do not defeat the safety purpose of the plug by modifying the plug in any way or using an adaptor. If the plug does not fit, reverse the plug. If it still does not fit, have an electrician replace the outlet.

IMPORTANT SAFEGUARDS

When using electric appliances, basic safety precautions should always be followed, including the following:

1. Read all instructions.
2. To reduce the risk of electrical shock, do not put cord, plug, or mixer body in water or other liquid.
3. Close supervision is necessary when any appliance is used by or near children.
4. Unplug from outlet when not in use, before putting on or taking off parts, and before cleaning.
5. Avoid contacting moving parts. Keep hands, hair, and clothing, as well as spatulas and other utensils, away from beaters during operation to reduce risk of injury to persons, and/or damage to mixer.
6. Remove beaters from mixer before washing.
7. Do not operate any appliance with a damaged cord or plug, or after the appliance malfunctions or is dropped or damaged in any manner. Call our toll-free customer assistance number for information on examination, repair, or electrical or mechanical adjustment.
8. The use of attachments not recommended or sold by the appliance manufacturer for use with this model may cause fire, electric shock, or injury.
9. Do not use outdoors.
10. Do not let cord hang over edge of table or counter, or touch hot surfaces, including stove.
11. Do not place on or near a hot gas or electric burner, or in a heated oven.
12. Check that control is off before plugging cord into wall outlet. To disconnect, turn control to OFF, then remove plug from wall outlet.
13. Do not use appliance for other than intended purpose.

SAVE THESE INSTRUCTIONS!

Other Consumer Safety Information

This appliance is intended for household use only.

WARNING: To reduce risk of personal injury, always unplug mixer before inserting or removing beaters.

BEFORE FIRST USE: Wash attachments in hot, soapy water. Rinse and dry.

PARTS AND FEATURES

1. Speed Control (On/Off) and Eject
2. Beaters
3. Mixer Body
4. Hand Mixer Stabilizer
5. Power Surge Button*

*Available on selected models

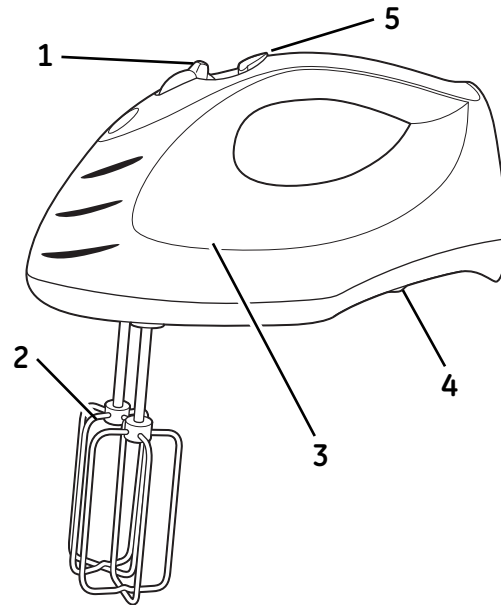

ATTACHMENTS

To ensure safety, unplug mixer from electrical outlet before inserting or removing attachments.

Attachment

Description

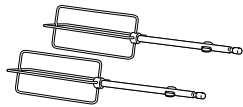

The wire beaters are designed for general mixing purposes.

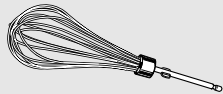

The single whisk is perfect for whipping cream or beating egg whites. The whisk may be inserted into either opening.

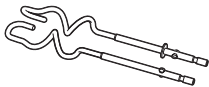

The dough hooks can perfectly knead a one loaf bread recipe. Only use dough hooks on speeds 3 through 6. **Available on selected models.**

TO INSERT BEATERS

1. Make sure mixer is unplugged and speed control is set to **0** (OFF).
2. Insert a beater into an opening on the bottom of the mixer. Push until it clicks into place. Repeat with other beater.

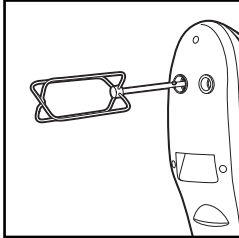

TO INSERT WHISK

1. Make sure mixer is unplugged and speed control is set to **0** (OFF).
2. Insert whisk into either opening on the bottom of the mixer. Push until it clicks into place.

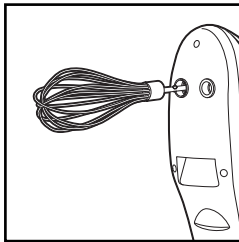

TO INSERT DOUGH HOOKS (ON SOME MODELS)

1. Make sure mixer is unplugged and speed control is set to **0** (OFF).
2. Insert dough hook with collar into left-side opening on the bottom of the mixer. Push until it clicks into place. Repeat with the dough hook that does not have a collar in the other opening.

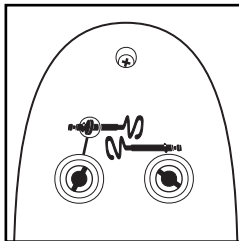

3. Use dough hooks with speeds 3 to 6 to knead dough. Do not knead dough continuously for more than 5 minutes or the mixer may overheat. Do not knead more than one loaf at a time.

HOW TO USE YOUR MIXER

1. Make sure mixer is unplugged and speed control is set to **0** (OFF). Insert beaters.
2. Plug mixer into electrical outlet. Place beaters into bowl.
3. Move the speed control to desired speed, starting at 1 and increasing to a higher speed as necessary.

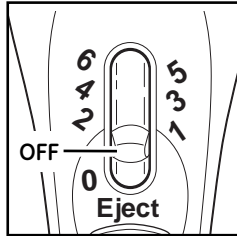

4. When finished mixing, move the speed control to **0** (OFF) and unplug mixer.
5. To eject beaters, with speed control set at **0** (OFF) push straight down on the speed control.

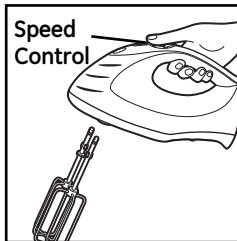

MIXER FEATURES

Power Surge (on selected models)

Press and hold down the button for additional power at any speed.

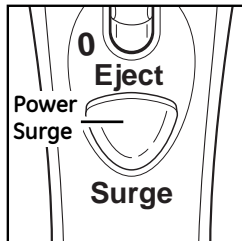

NOTE: Do not use Power Surge for more than two minutes at a time or motor may overheat.

Hand Mixer Stabilizer

CAUTION: Never use the stabilizer when the mixer is on. Do not use the stabilizer on small (1½ quart) mixing bowls or plastic mixing bowls. This feature can be used on most large mixing bowls. Use the stabilizer while adding ingredients or checking a recipe. To use, TURN MIXER OFF, then set the mixer on the edge of the bowl

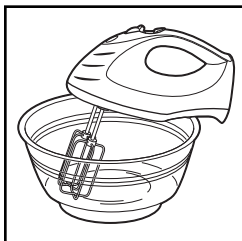

MIXING GUIDE

The following mixing guide is a suggestion for selecting mixing speeds for the 6 speed mixers. Begin on speed 1 and increase to desired speed depending on the recipe consistency.

6 SPEED	FUNCTION
0	OFF and/or Eject
1	LOW speed for folding or mixing in dry ingredients, muffins, or quick breads
2	To cream butter and sugar; most cookie dough
3	MEDIUM speed for most packaged cake mixes; bread dough
4	Frosting and mashed potatoes; bread dough
5	Beating egg whites; bread dough
6	HIGH speed for whipping cream; bread dough

NOTE: Dough hooks should only be used on speeds 3 through 6.

COOKIE DOUGH MIXING TIPS

Cookie dough is one of the thickest doughs to mix. Make it easier by following these tips:

- Use a large mixing bowl so that the ingredients spread out for easier mixing.
- Have butter or margarine at room temperature.
- Add ingredients one at a time and thoroughly mix after each addition.
- Add flour one cup at a time.
- To add chips or nuts to a very thick dough or batter, we recommend stirring them in by hand at the very end of the recipe.

CLEANING YOUR MIXER

1. Always turn off and unplug mixer from electrical outlet before ejecting attachments.
2. Wash attachments in hot, soapy water; rinse and dry.
3. Wipe the mixer body and cord with a clean, damp cloth.

NOTES:

- Do not use abrasive cleaners or scouring pads.
- To reduce the risk of electrical shock do not immerse the mixer body or cord in water or other liquid.
- The optional storage case should be wiped clean with a damp cloth. It is not dishwasher safe.

RECIPES

Baked Spinach-Parmesan Dip

10-ounce package frozen chopped spinach, thawed
 1 cup mayonnaise
 3-ounce package creamcheese, room temperature
 ½ cup onion, minced
 1 clove garlic, minced
 1 cup grated Parmesan cheese
 ⅛ teaspoon pepper
 ½ teaspoon paprika
 1 baguette, thinly sliced

Squeeze spinach to remove liquid. In a medium bowl combine spinach, mayonnaise, cream cheese, onion, garlic, cheese, and pepper. With hand mixer, beat ingredients at MEDIUM speed until well blended, about one minute. Spoon the mixture into a three or four cup baking dish that has been sprayed with nonstick cooking spray. Sprinkle evenly with paprika. Bake at 350°F until hot in center and lightly browned on top, about 25 to 30 minutes. Serve hot to spread on baguette slices. **Makes appetizers for 10.**

Zesty Mashed Potatoes

8 large baking potatoes (peeled, cubed, cooked, and drained)
 ½ cup sour cream
 8-ounce package cream cheese, room temperature
 ½ cup butter, room temperature
 ½ cup milk
 ½ to 1 teaspoon minced garlic
 Salt and pepper to taste

Place hot potatoes into a large bowl. Start mixing the potatoes at MEDIUM speed until they are smooth. Add sour cream, cream cheese, butter, milk, garlic, salt, and pepper and continue beating until thoroughly mixed. Pour into a greased 9x13-inch baking dish. Baked uncovered for 30 minutes at 400°F. **Makes 8 servings.**

Wedding Cookies

1 cup butter, room temperature
 4 tablespoons sugar
 2 teaspoons vanilla
 1½ cups flour
 2 cups finely chopped pecans*
 1½ cups confectioners sugar

In a medium bowl, cream butter and sugar on MEDIUM speed with hand mixer. Add vanilla and continue mixing on MEDIUM. Add flour and mix on LOW until blended. Pour in pecans and continue mixing on LOW until completely blended. Roll dough into 1-inch balls and place on an ungreased baking sheet. Bake for 25 minutes at 325°F. Place a paper towel over a wire rack. Remove cookies onto wire rack. Place confectioners sugar into plastic or paper bag. Drop 3 or 4 cookies into bag. Shake bag to coat cookies and return cookies to rack to cool completely. Continue until all cookies have been coated with confectioners sugar. Before storing cookies, shake cookies in bag of confectioners sugar one more time. **Makes 4½ dozen.**

* 2 cups pecan halves or pieces is equivalent to 2 cups finely chopped.

Triple Chocolate Cookies

¼ cup flour
 ¼ cup unsweetened baking cocoa
 ¼ teaspoon baking powder
 ⅓ teaspoon salt
 6 tablespoons butter, room temperature
 7 tablespoons sugar
 2 eggs
 8 ounces semisweet baking chocolate, melted and cooled
 1 cup milk chocolate chips
 1 cup chopped walnuts

Combine flour, cocoa, baking powder, and salt in a medium bowl. Set aside. With mixer, beat together butter, sugar, and eggs at MEDIUM speed until smooth. Add melted chocolate and continue mixing on MEDIUM speed until blended. Reduce speed to LOW and add dry ingredients. Add chocolate chips and walnuts; mix well. Drop by tablespoons onto cookie sheets, one inch apart. Bake at 350°F until cookies look dry and cracked, but feel soft when lightly pressed, about 11 minutes. Let cookies stand on sheet for 5 minutes. Transfer to racks and cool completely. **Makes about 2 dozen.**

Creamy Peanut Butter Pie

1 cup butter
 1 cup packed brown sugar
 1 cup peanut butter
 12-ounce container frozen whipped topping, thawed
 9-inch graham crust
 2 ounces semi-sweet baking chocolate
 2 tablespoons butter
 1 tablespoon milk

In a medium saucepan, combine 1 cup butter and brown sugar. Cook over medium heat until butter is melted and mixture is smooth, stirring frequently. Refrigerate 10 minutes. In large bowl, beat peanut butter and brown sugar mixture at LOW speed until blended. Increase speed and beat one minute at HIGH speed. Reduce speed to LOW and add whipped topping; beat one additional minute. Pour into graham crust and refrigerate. In a small saucepan over low heat, melt chocolate, 2 tablespoons butter, and milk. Stir constantly until smooth. Cool slightly then spread over top of pie. Refrigerate for several hours or overnight before serving. **Makes one 9-inch pie.**

Orange Pineapple Cake

18¾-ounce box yellow cake mix
 4 eggs
 11-ounce can mandarin oranges, undrained
 ½ cup vegetable oil
 15¼-ounce can crushed pineapple, undrained
 1-ounce box vanilla sugar-free instant pudding
 12-ounce container frozen light whipped topping, thawed

In a large bowl, blend cake mix, eggs, oranges, and oil at MEDIUM speed for 3 to 5 minutes. Divide batter into two greased and floured 9-inch round cake pans. Bake approximately 45 minutes at 325°F. Let cake cool on wire racks. To make icing, in a medium bowl, beat pineapple, pudding, and whipped topping mix at LOW speed for 3 minutes. Ice the cooled cake and store in the refrigerator. **Makes 8-12 servings.**

(Tip: Cake flavor is enhanced if left overnight in refrigerator.)

Pound Cake

1 cup butter, room temperature
 3 cups sugar
 6 eggs
 1 teaspoon vanilla extract
 1 teaspoon almond extract (optional)
 1 cup whipping cream
 3 cups flour

In a large mixing bowl, cream together butter and sugar on MEDIUM speed. Add eggs, one at a time, and beat thoroughly after each addition. Add vanilla and almond extracts and continue mixing. Reduce speed to LOW and alternately add cream and flour. Pour batter into a greased and floured 10-inch tube pan. Bake for about 1 hour and 20 minutes at 325°F, or until tests done. **Makes 16 servings.**

Brown Sugar Butterscotch Cookies

1 cup butter, room temperature
 1 cup white sugar
 1 cup brown sugar
 2 eggs
 2 teaspoon vanilla
 2½ cups flour
 ½ teaspoon salt
 1 teaspoon baking soda
 4 cups crispy rice cereal
 2 cups butterscotch chips

In a large mixing bowl, on MEDIUM speed mix butter and sugars. Add eggs and vanilla and continue mixing. Add flour, salt, and baking soda and mix on MEDIUM until just mixed. Add rice cereal and chips and mix on MEDIUM until mixed. Drop by spoonfuls onto cookie sheet. Bake at 350°F for 12 to 15 minutes or until lightly browned.

Makes 6 dozen.

Basic White Bread

1 package active dry yeast
 1¼ cups warm water
 1½ tablespoons butter or margarine, melted
 1½ tablespoons sugar
 1 teaspoon salt
 3 to 3½ cups all-purpose flour

In a large mixing bowl, combine yeast and ¼ cup of warm water. Stir until dissolved. Add remaining warm water, butter, sugar, and salt. Stir until mixed. Add 3 cups of flour and using dough hooks on speed 4 or 5 mix until blended. Add enough of remaining flour until dough forms a smooth ball that is slightly sticky to the touch. Place dough in large, greased bowl. Cover and let rise until double in size, about 1 hour. Punch dough down and shape into loaf. Place loaf into 9x5-inch greased loaf pan and let rise until double in size, about 1 hour. Bake in 350°F oven for 40 minutes. **Makes 1 loaf.**

CUSTOMER SERVICE

If you have a claim under this warranty, please call our Customer Assistance Number. For faster service please have model, series, and type numbers ready for operator to assist you. These numbers can be found on the bottom of your appliance.

MODEL: _____ **TYPE:** _____ **SERIES:** _____

Customer Assistance Number 1-877-207-0923 (US) or 1-877-556-0973 (Canada)

Keep these numbers for future reference!

For more information, please visit us at www.walmart.com

Two-Year Limited Warranty

What does your warranty cover?

- Any defect in material or workmanship.

For how long after the original purchase?

- Two years.

What will we do?

- Provide you with a new one.
- For those items still under warranty but no longer available, WAL-MART reserves the right to replace with a similar GE branded product of equal or greater value.

How do you make a warranty claim?

- Save your receipt.
- Properly pack your unit. We recommend using the original carton and packing materials.
- Return the product to your nearest WAL-MART store or call Customer Assistance at 1-877-207-0923 (US) or 1-877-556-0973 (Canada)

What does your warranty not cover?

- Parts subject to wear, including, without limitation, glass parts, glass containers, cutter/strainer, blades, seals, gaskets, clutches, motor brushes, and/or agitators, etc.
- Commercial use or any other use not found in printed directions.
- Damage from misuse, abuse, or neglect, including failure to clean product regularly in accordance with manufacturer's instructions.

How does state law relate to this warranty?

- This warranty gives you specific legal rights, and you may also have other rights which vary from state to state or province to province.

- THIS WARRANTY IS IN LIEU OF ANY OTHER WARRANTY OR CONDITION, WHETHER EXPRESS OR IMPLIED, WRITTEN OR ORAL, INCLUDING, WITHOUT LIMITATION, ANY STATUTORY WARRANTY OR CONDITION OF MERCHANTABILITY OR FITNESS FOR A PARTICULAR PURPOSE.

- WAL-MART, GE, AND THE PRODUCT MANUFACTURER EXPRESSLY DISCLAIM ALL RESPONSIBILITY FOR SPECIAL, INCIDENTAL, AND CONSEQUENTIAL DAMAGES OR LOSSES CAUSED BY USE OF THIS APPLIANCE. ANY LIABILITY IS EXPRESSLY LIMITED TO AN AMOUNT EQUAL TO THE PURCHASE PRICE PAID WHETHER A CLAIM, HOWEVER INSTITUTED, IS BASED ON CONTRACT, INDEMNITY, WARRANTY, TORT (INCLUDING NEGLIGENCE), STRICT LIABILITY, OR OTHERWISE. SOME STATES OR PROVINCES DO NOT ALLOW THIS EXCLUSION OR LIMITATION OF INCIDENTAL OR CONSEQUENTIAL LOSSES SO THE FOREGOING DISCLAIMER MAY NOT APPLY TO YOU.

What if you encounter a problem with this product while using it outside the country of purchase?

- The warranty is valid only in the country of purchase and you follow the warranty claim procedure as noted.

Free Manuals Download Website

<http://myh66.com>

<http://usermanuals.us>

<http://www.somanuals.com>

<http://www.4manuals.cc>

<http://www.manual-lib.com>

<http://www.404manual.com>

<http://www.luxmanual.com>

<http://aubethermostatmanual.com>

Golf course search by state

<http://golfingnear.com>

Email search by domain

<http://emailbydomain.com>

Auto manuals search

<http://auto.somanuals.com>

TV manuals search

<http://tv.somanuals.com>