

Owner's Manual

30" Convection
Wall Oven

ZET1038
ZET1058



Monogram.[®]

Introduction

Your new Monogram wall oven makes an eloquent statement of style, convenience and kitchen planning flexibility. Whether you chose it for its purity of design, assiduous attention to detail—or for both of these reasons—you'll find that your Monogram wall oven's superior blend of form and function will delight you for years to come.

Your Monogram wall oven was designed to provide the flexibility to blend in with your kitchen cabinetry. Its sleek design can be beautifully integrated into the kitchen.

The information on the following pages will help you operate and maintain your wall oven properly.

Contents

Care and Cleaning

Broiler Pan, Grid and	
Convection Roasting Rack	29
Oven Door	31
Oven Lights	30
Racks	29

Consumer Services

Important Phone Numbers	35
Model and Serial Number	3
Problem Solver	32
Product Registration	3
Safety Instructions	4-9
Warranty	36

Oven

Adjust the Oven Thermostat	26
Aluminum Foil	6, 7, 13, 19, 22
Baking/Roasting	13, 20
Broiling/Broiling Guide	22, 23
Controls	11, 14, 15, 17, 19, 20-22, 24, 25, 27
Convection Cooking	15-19
Features	10
Proofing	21
Self-Cleaning Instructions	27, 28
Timed Cooking	24, 25

Consumer Information

Wall Oven

*Before
using your
wall oven*

Read this manual carefully. It is intended to help you operate and maintain your new wall oven properly.

Keep it handy for answers to your questions.

If you don't understand something or need more help, there is a list of toll-free consumer service numbers included in the back section of this manual.

OR

Visit our Website at: www.monogram.com

*Write
down the
model &
serial
numbers*

You'll find them on a label on the front trim behind the oven door.

Fill out and return the Consumer Product Registration Card that is packed with this product.

Before sending in this card, please write these numbers here:

Model Number

Serial Number

Use these numbers in any correspondence or service calls concerning your wall oven.

*If you
received a
damaged
wall oven*

Immediately contact the dealer (or builder) that sold you the wall oven.

*Save time
& money*

Before you request service, check the Problem Solver in the back of this manual.

It lists causes of minor operating problems that you can correct yourself.

*If you
need
service*

To obtain service, see the Consumer Services page in the back of this manual.

We're proud of our service and want you to be pleased. If for some reason you are not happy with the service you receive, here are two steps to follow for further help.

FIRST, contact the people who serviced your appliance. Explain why you are not pleased. In most cases, this will solve the problem.

NEXT, if you are still not pleased, write all the details—including your phone number—to:

Manager, Customer Relations
GE Appliances
Appliance Park
Louisville, KY 40225

IMPORTANT SAFETY INSTRUCTIONS

IMPORTANT SAFETY NOTICE

- **The California Safe Drinking Water and Toxic Enforcement Act** requires the Governor of California to publish a list of substances known to the state to cause cancer, birth defects or other reproductive harm, and requires businesses to warn customers of potential exposure to such substances.
- **The fiberglass insulation in self-clean ovens gives off a very small amount of carbon monoxide during the cleaning cycle.** Exposure can be minimized by venting with an open window or using a ventilation fan or hood.
- **IMPORTANT:** The health of some birds is extremely sensitive to the fumes given off during the self-cleaning cycle of any oven. Move birds to another well-ventilated room.

SAFETY PRECAUTIONS

When using your electrical appliances, basic safety precautions should be followed, including the following:

- **Be sure all packing materials are removed from the oven** before operating it to prevent fire or smoke damage should the packing material ignite.
- **Use this appliance only for its intended use** as described in this Owner's Manual.
- **Be sure your appliance is properly installed and grounded** by a qualified technician in accordance with the provided installation instructions.
- **Be sure the oven is securely installed in a cabinet that is firmly attached to the house structure.** Never allow anyone to climb, sit, stand or hang on the oven door.
- **Have the installer show you the location of the circuit breaker or fuse.** Mark it for easy reference.
- **Do not attempt to repair or replace any part of your wall oven unless it is specifically recommended in this manual.** All other servicing should be referred to a qualified technician.
- **Teach children not to play with the controls** or any other part of the oven.
- **Never leave the oven door open** when you are not watching the oven.
- **Always keep dish towels, dish cloths, pot holders and other linens a safe distance from your oven.**
- **For your safety, never use your appliance for warming or heating the room.**
- **Do not store flammable materials in the oven.**
- **Always keep wooden and plastic utensils and canned food a safe distance away from your oven.**
- **Always keep combustible wall coverings, curtains or drapes a safe distance from your oven.**
- **DO NOT STORE OR USE COMBUSTIBLE MATERIALS, GASOLINE OR OTHER FLAMMABLE VAPORS AND LIQUIDS IN THE VICINITY OF THIS OR ANY OTHER APPLIANCE.**
- **Do not let cooking grease or other flammable materials accumulate in or near the wall oven.**
- **Do not use water on grease fires.** Never pick up a flaming pan. Turn the controls off.
Flame in the oven can be smothered completely by closing the oven door and turning the oven off or by using a multi-purpose dry chemical or foam-type fire extinguisher.

MESURES DE SÉCURITÉ IMPORTANTES

AVIS IMPORTANT EN MATIÈRE DE SÉCURITÉ

- **Le California Safe Drinking Water and Toxic Enforcement Act** exige que le gouverneur de Californie publie une liste de substances que l'on sait occasionner le cancer, des anomalies congénitales ou d'autres anomalies de reproduction, et exige que les entreprises avertissent leurs clients des dangers que leur font courir une exposition à ces substances.
- **L'isolement en fibre de verre dans les fours auto-nettoyants émet un très petit montant de gaz carbonique pendant le cycle de nettoyage.** Vous pouvez réduire votre exposition à ce gaz en aérant, en ouvrant la fenêtre ou en utilisant un ventilateur ou une hotte d'aération.
- **IMPORTANT:** Certains oiseaux sont extrêmement sensibles à la fumée produite pendant le programme d'autonettoyage de n'importe quel four. Placez les oiseaux dans une autre pièce bien aérée.

MESURES DE SÉCURITÉ

Pour utiliser des appareils électroménagers, vous devez suivre des précautions élémentaires de sécurité, en particulier :

- **Assurez-vous d'enlever tous les matériaux d'emballage du four** avant de le mettre en marche, pour éviter tout danger d'incendie ou de dommage dû à la fumée si ces matériaux d'emballage prennent feu.
- **N'utilisez cet appareil que pour l'usage auquel il est destiné**, comme expliqué dans le présent Manuel du propriétaire.
- **Assurez-vous que votre appareil est bien installé et mis à la terre** par un installateur qualifié, conformément aux directives d'installation fournies.
- **Assurez-vous que le four est bien installé dans une armoire solidement fixée à la charpente de la résidence.** Ne laissez personne grimper, s'asseoir ou monter sur la porte du four, ou s'y agripper.
- **Demandez à l'installateur de vous montrer l'emplacement du disjoncteur ou du fusible.** Identifiez-le pour pouvoir le trouver facilement.
- **Ne tentez pas de réparer ni de remplacer aucune pièce du four, à moins que cela ne soit recommandé dans le présent manuel.** Tout autre service d'entretien doit être assuré par un réparateur qualifié.
- **Apprenez aux enfants à ne pas jouer avec les commandes** ou toute autre pièce du four.
- **Ne laissez jamais la porte du four ouverte** lorsque vous ne surveillez pas l'appareil.
- **Gardez toujours les linges à vaisselle, les mitaines de four et autres articles en tissu à une distance sécuritaire de votre four.**
- **Pour votre sécurité, n'utilisez pas cet appareil pour réchauffer la pièce.**
- **Ne rangez pas de matériaux inflammables dans le four.**
- **Gardez toujours les ustensiles en plastique et en bois, de même que les aliments en conserve, à une distance sécuritaire de votre four.**
- **Gardez toujours les revêtements muraux combustibles, les rideaux et les tentures à une distance sécuritaire de votre four.**
- **NE PAS EMMAGASINEZ OU UTILISEZ DES MATÉRIELS COMBUSTIBLES, L'ESSENCE OU LES AUTRES VAPEURS ET LES LIQUIDES INFLAMMABLES À PROXIMITÉ DE CECI OU AUCUN AUTRE APPAREIL.**
- **Ne laissez pas de graisse ou autres matières inflammables s'accumuler dans le four ou à proximité de ce dernier.**
- **Ne tentez pas d'éteindre des feux de graisse avec de l'eau.** Ne soulevez jamais une casserole en flammes. Mettez tous les réglages en position off (arrêt).

Vous pouvez éteindre complètement les flammes en fermant la porte du four et en éteignant l'appareil, ou en utilisant un extincteur chimique à poudre ou à mousse.

IMPORTANT SAFETY INSTRUCTIONS

SAFETY PRECAUTIONS

- **Do not use aluminum foil to line oven bottoms, except as suggested in this manual.** Improper installation of aluminum foil may result in a risk of electric shock or fire.
- **Cook meat and poultry thoroughly**—meat to at least an INTERNAL temperature of 160°F and poultry to at least an INTERNAL temperature of 180°F. Cooking to these temperatures usually protects against foodborne illness.
- **Before performing any service, DISCONNECT THE OVEN POWER SUPPLY AT THE HOUSEHOLD DISTRIBUTION PANEL BY REMOVING THE FUSE OR SWITCHING OFF THE CIRCUIT BREAKER.**
- **Do not leave children alone**—children should not be left alone or unattended in an area where an appliance is in use. They should never be allowed to sit or stand on any part of the appliance.
- **Do not touch the heating elements or the interior surface of the oven.** These surfaces may be hot enough to burn even though they are dark in color. During and after use, do not touch, or let clothing or other flammable materials contact, any interior area of the oven; allow sufficient time for cooling first.

Potentially hot surfaces include the oven vent openings and surfaces near the openings, crevices around the oven door, the edges of the door window and metal trim parts above the door.

Remember: The inside surface of the oven may be hot when the door is opened.
- **CAUTION: ITEMS OF INTEREST TO CHILDREN SHOULD NOT BE STORED IN CABINETS ABOVE AN OVEN—CHILDREN CLIMBING ON THE OVEN TO REACH ITEMS COULD BE SERIOUSLY INJURED.**
- **Never wear loose-fitting or hanging garments while using the appliance.** Be careful when reaching for items stored over the oven. Flammable material could be ignited if brought in contact with oven heating elements and may cause severe burns.
- **Use only dry pot holders**—moist or damp pot holders on hot surfaces may result in burns from steam. Do not let pot holders touch hot heating elements. Do not use a towel or other bulky cloth.
- **Keep the oven vent unobstructed.**
- **Keep the oven free from grease buildup.**
- **Stand away from the oven when opening the oven door.** Hot air or steam which escapes can cause burns to hands, face and/or eyes.
- **Never “open door broil” with children nearby.** They could quickly come into contact with a hot oven interior surface, causing severe burns.
- **After broiling, always take the broiler pan out of the oven and clean it.** Leftover grease in the broiler pan can catch fire the next time you use the pan.
- **Large scratches or impacts to glass doors can lead to broken or shattered glass.**
- **Never leave jars or cans of fat drippings in or near your oven.**

MESURES DE SÉCURITÉ IMPORTANTES

MESURES DE SÉCURITÉ

- **N'utilisez pas de papier d'aluminium pour couvrir la sole du four, sauf de la façon indiquée dans le présent manuel.** Une utilisation inadéquate du papier d'aluminium peut présenter des risques de chocs électriques ou d'incendie.
- **Faites cuire la viande et la volaille à fond**—la température INTERNE de la viande doit être d'au moins 160 °F, et celle de la volaille d'au moins 180 °F. La cuisson à ces températures internes assure généralement une bonne protection contre les intoxications alimentaires.
- **Avant d'effectuer une réparation, COUPEZ TOUJOURS L'ALIMENTATION DU FOUR AU PANNEAU DE DISTRIBUTION EN ENLEVANT LE FUSIBLE OU EN DÉCLENCHANT LE DISJONCTEUR.**
- **Ne laissez pas les enfants sans surveillance**— Il ne faut jamais laisser les enfants seuls ou sans surveillance près de l'appareil, lorsque celui-ci fonctionne. On doit également leur interdire de grimper ou de s'asseoir sur l'appareil.
- **Ne touchez pas aux éléments chauffants, ni aux parois du four.** Ces surfaces peuvent être suffisamment chaudes pour causer des brûlures, même si elles ne sont pas rouges. Pendant et après l'utilisation, faites en sorte que vos vêtements et autres matériaux inflammables ne viennent pas en contact avec les parois du four. Laissez-les d'abord refroidir.

Les surfaces susceptibles de devenir chaudes comprennent notamment l'évent du four et les surfaces qui l'entourent, les aspérités autour de la porte du four, la surface périphérique du hublot et les moulures métalliques au-dessus de la porte.

N'oubliez pas : Les parois du four peuvent être chaudes lorsque vous ouvrez la porte.

- **ATTENTION : NE RANGEZ PAS DES ARTICLES QUI PRÉSENTENT UN INTÉRÊT POUR LES ENFANTS, DANS LES ARMOIRES SE TROUVANT AU-DESSUS D'UN FOUR CAR CEUX-CI POURRAIENT GRIMPER SUR L'APPAREIL POUR LES ATTEINDRE ET RISQUERAIENT DE SE BLESSER.**
- **Ne portez jamais de vêtements amples lorsque vous utilisez cet appareil.** Faites attention lorsque vous prenez des articles rangés dans les armoires au-dessus du four. Les tissus inflammables peuvent prendre feu au contact des surfaces chaudes et causer de graves brûlures.
- **N'utilisez que des poignées ou des mitaines de four sèches**—les poignées ou mitaines de four humides ou mouillées peuvent causer des brûlures de vapeur. Ne laissez pas les poignées venir en contact avec les éléments chauds. N'utilisez pas de serviette ou autre objet encombrant en tissu au lieu de mitaines de four.
- **Assurez-vous que l'évent du four n'est jamais obstrué.**
- **Ne laissez pas s'accumuler de dépôts graisseux dans le four.**
- **Ne vous tenez pas trop près du four lorsque vous ouvrez la porte.** L'air chaud et la vapeur qui s'en échappent peuvent vous brûler les mains, le visage et les yeux.
- **N'ouvrez jamais la porte de grillage à proximité d'enfants.** Ils peuvent entrer rapidement en contact avec la surface intérieure brûlante du four, et se brûler sérieusement.
- **Après le grillage, sortez toujours la lèchefrite du four et nettoyez-la.** La graisse qui s'est accumulée dans la lèchefrite pourrait prendre feu la prochaine fois que vous utiliserez le four.
- **De grandes égratignures ou des impacts sur la surface vitrée des portes peuvent entraîner le bris du verre.**
- **Ne laissez jamais de pots à graisse ou de boîtes de conserve contenant des matières grasses à proximité de votre four.**

IMPORTANT SAFETY INSTRUCTIONS

SAFETY PRECAUTIONS

- **Children in walkers, or children crawling, can be attracted to the round oven door handle and may grab and open the oven door.** This can result in injury from the door being pulled open on a child, or severe burns if the oven is in use and hot.
- **Do not heat unopened food containers.** Pressure could build up and the container could burst, causing an injury.
- **Place the oven rack in the desired position while the oven is cool.** If racks must be handled when hot, do not let pot holder contact the heating elements.
- **Pulling out the rack to the stop-lock is a convenience in lifting heavy foods.** It is also a precaution against burns from touching hot surfaces of the door or oven walls.
- **When using cooking or roasting bags in the oven,** follow the manufacturer's directions.
- **Do not use your oven to dry newspapers.** If overheated, they can catch on fire.
- **Do not use oven for a storage area.** Items stored in an oven can ignite.
- **Do not leave paper products, cooking utensils or food in the oven when not in use.**
- **Do not allow anyone to climb, stand or hang on the door.** They could damage the oven or cause severe personal injury.

SELF-CLEANING OVEN

- **Do not clean the door gasket.** The door gasket is essential for a good seal. Care should be taken not to rub, damage or move the gasket.
- **Do not use oven cleaners.** No commercial oven cleaner or oven liner protective coating of any kind should be used in or around any part of the oven. Residue from oven cleaners will damage the inside of the oven when the self-clean cycle is used.
- **Clean only parts listed in this Owner's Manual.**
- **Before self-cleaning the oven,** remove the broiler pan, grid and other cookware.
- **Be sure to wipe up excess spillage before starting the self-cleaning operation.**
- **If the self-cleaning mode malfunctions,** turn the oven off and disconnect the power supply. Have it serviced by a qualified technician.
- **The oven racks may be cleaned in the oven during the self-cleaning cycle.**

SAVE THESE INSTRUCTIONS

MESURES DE SÉCURITÉ IMPORTANTES

MESURES DE SÉCURITÉ

- **Les enfants en marchette ou les enfants qui rampent peuvent être attirés par la poignée ronde de porte du four et peuvent la saisir, et ainsi ouvrir la porte.** Cela peut occasionner une ouverture de la porte sur l'enfant ou des brûlures sérieuses si le four est en fonctionnement et chaud.
- **Ne faites pas chauffer de récipient fermé.** L'accumulation de pression dans le récipient peut le faire éclater, causant ainsi des blessures.
- **Placez les clayettes à la hauteur désirée lorsque le four est froid.** Si vous devez les manipuler lorsque le four est chaud, évitez que vos mitaines de four entrent en contact avec les éléments du four.
- **Tirez la clayette jusqu'au verrouillage-arrêt si vous devez soulever des casseroles lourdes.** Vous éviterez ainsi de vous brûler en touchant aux parois de la porte ou du four.
- **Lorsque vous utilisez des sachets pour la cuisson ou le rôtissage,** suivez les directives du fabricant.
- **Ne faites pas sécher de journaux dans le four.** S'ils surchauffent, ils risquent de prendre feu.
- **N'entreposez pas d'articles dans votre four.** Ils pourraient prendre feu.
- **Ne laissez pas de produits en papier, d'ustensiles de cuisson ou d'aliments dans le four lorsqu'il n'est pas utilisé.**
- **Ne laissez personne grimper ou monter sur la porte du four, ou s'y agripper.** Cela pourrait endommager l'appareil ou causer de graves blessures.

FOUR AUTONETTOYANT

- **Ne nettoyez pas le joint de la porte.** Ce joint est essentiel à une bonne étanchéité. Il faut éviter de le récurer, de l'endommager ou de le déplacer.
- **N'utilisez pas de produits nettoyants commerciaux pour le four.** Il ne faut jamais utiliser des produits nettoyants commerciaux ou des enduits protecteurs dans le four ou près des pièces du four. Les résidus de ces produits nettoyants endommageront l'intérieur du four lorsque vous effectuerez un autonettoyage.
- **Ne nettoyez que les pièces indiquées dans le présent manuel d'utilisation.**
- **Avant de commencer l'autonettoyage,** enlevez la lèchefrite, la grille et autres ustensiles de cuisine.
- **Avant de commencer l'autonettoyage, essuyez les aliments renversés.**
- **Si le programme d'autonettoyage fonctionne mal,** éteignez le four et coupez l'alimentation électrique. Faites réparer l'appareil par un technicien qualifié.
- **Vous pouvez nettoyer les clayettes du four pendant le cycle d'auto-nettoyage.**

CONSERVEZ CES DIRECTIVES

Features of Your Wall Oven

Wall Oven

Design information

(Not all features are on all models. Appearance may vary.)

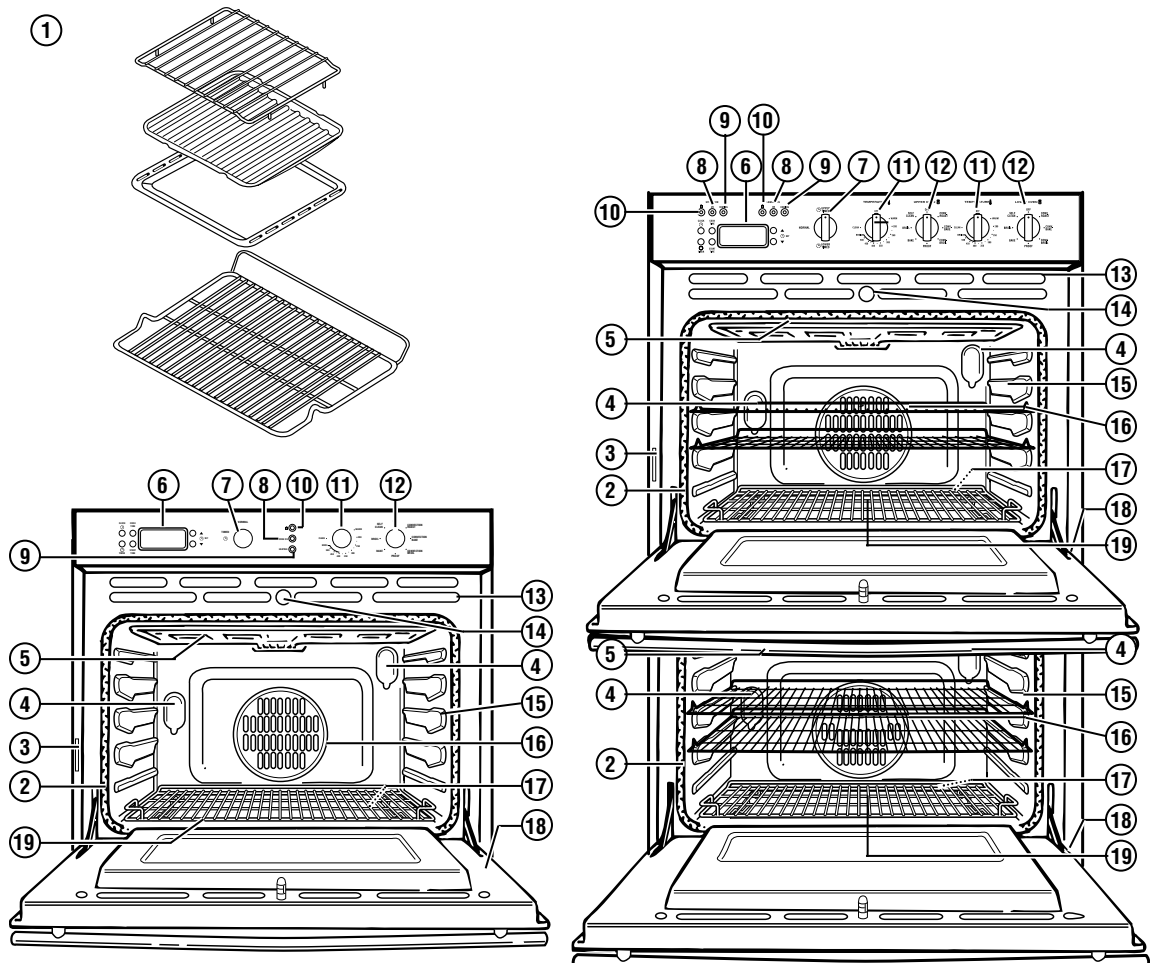

ZET1038—shown with Euro style knobs

ZET1058—shown with Pro style knobs

Feature Index	Page
1 Oven Rack (4 each oven), Broiler Pan, Grid and Convection Roasting Rack (1 each oven)	8, 20, 22, 23, 27, 29
2 Oven Door Gasket	8, 27, 31
3 Model and Serial Numbers	3, 34
4 Halogen Oven Lights	30
5 Broil Element	22, 29
6 Clock and Timer	11, 20
7 Mode Selector Knob (<i>knob appearance may vary</i>)	14, 15, 17, 19–22, 24, 25, 27, 28
8 Oven ON Light	14, 15, 17, 19–22, 24, 25, 27, 28
9 HEATING Light	14, 20–22, 24, 25, 27, 28
10 Locked Door Indicator Light	14, 27, 28
11 Temperature Control Knob (<i>knob appearance may vary</i>)	14, 15, 17, 19–22, 24–29
12 Oven Control Knob (<i>knob appearance may vary</i>)	14, 15, 17, 19–22, 24–29
13 Oven Vent	6, 7
14 Automatic Oven Door Latch	27, 28
15 Oven Rack Supports	20
16 Convection Fan	15
17 Bake Element (<i>under the oven floor</i>)	29
18 Oven Door	22
19 Convection Floor Rack	12

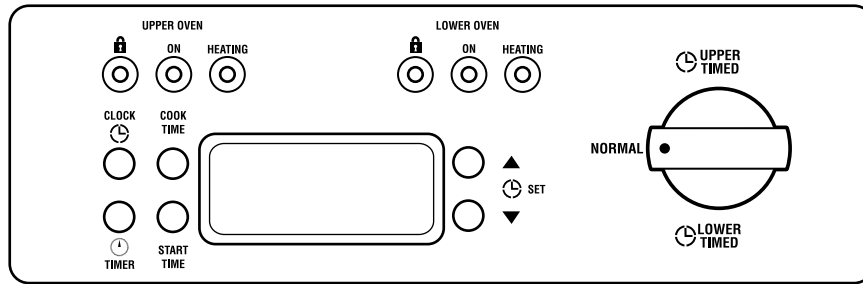

Double oven clock and timer (Pro style knob shown)

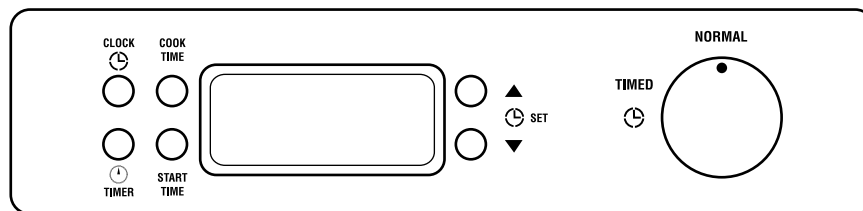

Single oven clock and timer (Euro style knob shown)

Using the clock and timer

When you first turn on the power to your oven, or after a power failure, the display will show all 8's, then dashes and the set clock symbol.

To set or change the time of day, press the CLOCK button. The control will beep. The set clock symbol will appear in the display.

Press the increase “▲” or decrease “▼” button.

If the increase “▲” or decrease “▼” button is pressed and released, it will change the time in one minute increments. If the increase “▲” or decrease “▼” button is pressed and held, the time will change in 10 minute increments.

Once the clock is set, press the CLOCK button again. The control will beep and the set clock symbol will disappear.

To check the time of day when the timer is in use, press the CLOCK button. The time of day will be displayed briefly and then will return to the timer function.

The timer button does not control oven functions. The timer may be used as a convenient kitchen timer.

To set, press the TIMER button. The control will beep. The display will show “:00” and the words SET TIMER.

Press the increase “▲” or decrease “▼” button to set the amount of time desired.

If the increase “▲” or decrease “▼” button is pressed and released, it will change the time in one minute increments. If the increase “▲” or decrease “▼” button is pressed and held, the time will change in 10 minute increments.

The timer will start automatically. The colon blinks when the timer starts counting down. The word TIMER will remain in the display during the countdown. The timer will count down in minutes until the last minute, then it will count down in seconds.

When timing is complete, the word TIMER will blink and the control will beep three times. The display will return to the time of day or any active programmed function and the control will beep twice every 10 seconds until any button is touched.

To cancel the timer, press the TIMER button once. If no time is set, the timer cancels itself after approximately 5 seconds. The time of day is then displayed.

Before You Begin

Wall Oven

Oven air flow

An internal cooling fan operates during all oven modes. The warm air from inside the oven will be exhausted out through vents located between the door and control panel.

Do not allow this air flow to be obstructed such as by draping kitchen towels over the front of the oven in undercounter applications.

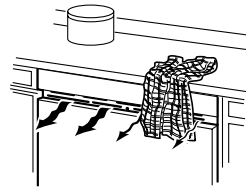

Oven racks

To avoid possible burns, place the racks in the correct position before you turn the oven on.

The correct rack position depends on the kind of food and the browning desired.

The racks have stop-locks, so that when placed correctly on the supports, they will stop before coming completely out, and will not tilt. When placing and removing cookware, pull the rack out to the bump on the rack support.

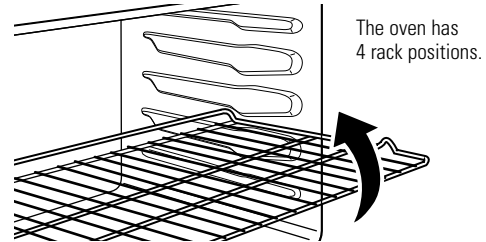

To remove a rack, pull it toward you, tilt the front end up and pull it out.

To replace, place the end of the rack (stop-locks) on the support, tilt up the front and push the rack in.

Convection Floor Rack

To avoid possible burns, always use oven mitts and the Rack Grasp Handles on each side when moving this special rack and **NEVER** pull this rack past the STOP position during cooking. This rack is designed to slide on the oven bottom and extend to stop against the open oven door.

To remove this rack, pull it toward you, tilt the front end up and pull out.

NOTE: This special rack is to be used only in the oven bottom position.

To replace, always be sure the Rack Grasp Handles are toward the front of the oven. Otherwise, foods could slide off the back during extension.

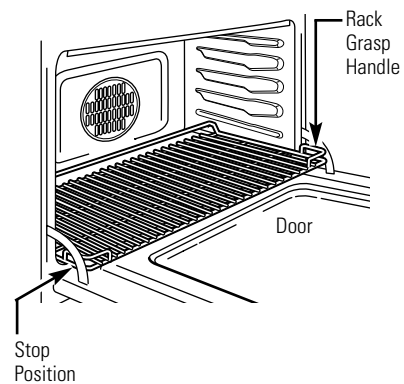

Baking pans/sheets

Use the proper baking pan. The type of finish on the pan determines the amount of browning that will occur.

- Dark, rough or dull pans absorb heat resulting in a browner, crisper crust. Use this type for pies.
- Shiny, bright and smooth pans reflect heat, resulting in a lighter, more delicate browning. Cakes and cookies require this type of pan or sheet.
- Glass baking dishes also absorb heat. When baking in glass baking dishes, the temperature may need to be reduced by 25°F.

Baking Tips

Wall Oven

Pan placement

For even cooking and proper browning, there must be enough room for air circulation in the oven. Baking results will be better if baking pans are centered as much as possible rather than being placed to the front or to the back of the oven.

Pans should not touch each other or the walls of the oven. Allow 1- to 1½" space between pans as well as from the back of the oven, the door and the sides.

If you need to use two racks, use rack positions A and C and stagger the pans so that one is not directly above the other.

Preheating

Preheat the oven if the recipe calls for it. To preheat, set the oven at the correct temperature—selecting a higher temperature does not shorten preheat time. Preheat the oven for at least 15 minutes, or until the HEATING light goes off. This may take up to 20 minutes.

Preheating is necessary for good results when baking cakes, cookies, pastry and breads. Preheat for at least 15 minutes.

The HEATING light will come on and stay on until the oven temperature reaches the pre-set temperature. When the light goes off, foods with recipes requiring a preheated oven should be placed in the oven.

NOTE: *This light will CYCLE on and off during the remainder of the cooking process.*

Aluminum foil

Never entirely cover a rack with aluminum foil. This will disturb the heat circulation and result in poor baking. A smaller sheet of foil may be used to catch a spillover by placing it on a lower rack several inches below the food.

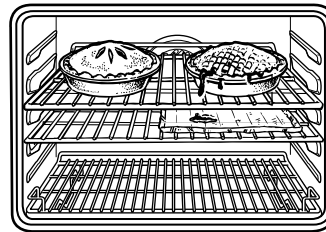

Convection fan

When using the convection oven, a fan circulates hot air over, under and around the food.

This circulating hot air is evenly distributed throughout the oven cavity. As a result, foods are evenly cooked and browned—often in less time with convection heat.

NOTE: *The convection fan will cycle on and off while cooking to best distribute hot air in the oven.*

DO NOT leave the door open for long periods of time while using convection cooking or you may shorten the life of the convection heating element.

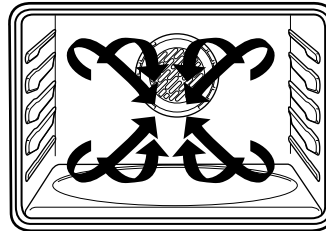

Cookware for convection cooking

Before using your convection oven, check to see if your cookware leaves room for air circulation in the oven. If you are baking with several pans, leave space between them. Also, be sure the pans do not touch each other or the walls of the oven.

Paper and Plastic

Heat-resistant paper and plastic containers that are recommended for use in regular ovens can be used in convection ovens. Plastic cookware that is heat-resistant to temperatures of 400°F can also be used.

Metal and Glass

Any type of cookware will work in your convection oven. However, metal pans heat the fastest and are recommended for convection baking.

Shiny (non-dark) pans are recommended for best results.

Glass or ceramic pans cook more slowly.

When baking cookies, you will get the best results if you use a flat, shiny (non-dark) cookie sheet instead of a pan with low sides.

For recipes like oven-baked chicken, use a pan with low sides. Hot air cannot circulate well around food in a pan with high sides.

Using the oven controls

Mode Selector Knob

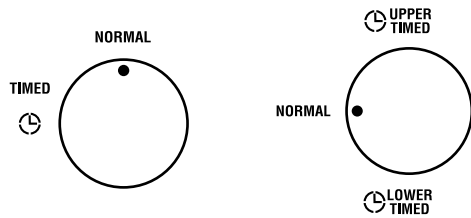

Single oven models

Double oven models

Use to set the oven for normal cooking or timed cook and cleaning functions.

NORMAL – Use for normal cooking functions.

TIMED – Use to set the oven to cook or clean for a selected length of time and turn off automatically. On double oven models, select **UPPER TIMED** or **LOWER TIMED** to choose which oven you want to set for timed cooking or cleaning.

Temperature Control Knob

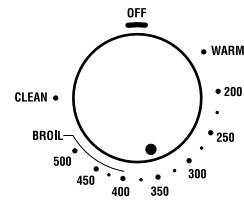

Use to set the oven temperature for cooking or cleaning.

WARM – Keeps cooked foods warm for up to 2 hours after the cooking function is finished, or can be activated independently to keep already cooked foods warm.

BROIL – Broil functions can be set at any temperature, though most broiling is done at temperatures above 400°F.

CLEAN – Temperature setting for self-clean cycle.

Indicator Lights



Lights come on when cooking and cleaning functions are operating. Double oven models have separate lights for the upper and lower ovens.

🔒 (Locked Door) – Light will come on and stay on while the oven door is locked during a self-clean cycle.

OVEN ON – Light will come on and stay on while any cooking or cleaning function is in use.

HEATING – Light will come on and stay on until the oven temperature reaches the pre-set temperature. This light will **CYCLE** on and off during the remainder of the cooking process.

Oven Control Knob

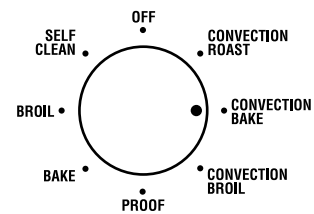

Use to select cooking or cleaning functions.

CONVECTION ROAST – Good for large tender cuts of meat, uncovered.

CONVECTION BAKE – Ideal for evenly browned baked foods cooked on single or multiple shelves.

CONVECTION BROIL – Good for broiling fish or smaller cuts of meat.

PROOF – Maintains a warm environment useful for rising yeast-leavened products.

BAKE – Use for standard, non-convection oven baking.

BROIL – Use for standard, non-convection broiling.

Convection Baking

Wall Oven

How to set the oven for convection baking

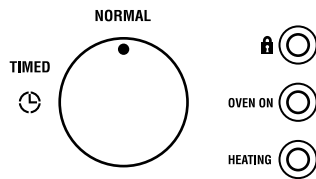

Mode Selector Knob

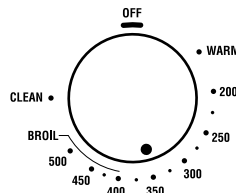

Temperature Control Knob

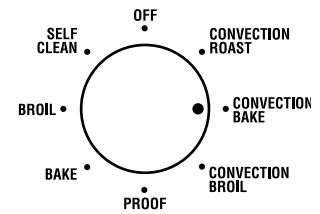

Oven Control Knob

Single oven controls shown.

Convection Baking is ideal for evenly browned baked foods cooked on single or multiple shelves. Preheating is not necessary with foods having a bake time of over 15 minutes.

When set on Convection Bake, the rear bake element operates whenever heating. (Fan operates.)

- 1 Turn the Mode Selector Knob to **NORMAL**.
- 2 Using the Temperature Control Knob, set the desired temperature, up to 500°F.
- 3 Turn the Oven Control Knob to **CONVECTION BAKE**.
- 4 Check the food for doneness at the minimum time on the recipe. Cook longer if necessary.
- 5 Turn the Oven Control Knob to **OFF** when convection cooking is finished.

The **OVEN ON** light and the oven interior lights turn on and remain on until the oven control knob has been turned to **OFF**.

The **HEATING** light will come on and stay on until the oven temperature reaches the pre-set temperature. This light will **CYCLE** on and off during the remainder of the cooking process.

NOTE:

- You will hear a convection fan while cooking with this feature.
- A cooling fan will turn on to cool internal parts. This is normal, and the fan may continue to run even after the oven is turned off.

Type of Food	Rack Position
Biscuits (1 rack)	B
Biscuits (3 racks)	A, B & C
Muffins and Cupcakes (1 rack)	B
Muffins and Cupcakes (2 racks)	A & C
Cookies (1 rack)	B
Cookies (3 racks)	A, B & C
2-Layer Cakes (1 rack)	B
4-Layer Cakes (2 racks)	A & C
1 Frozen Pie (1 rack)	B (on cookie sheet)
2 Frozen Pies (2 racks)	A & C (on cookie sheet)
Casseroles (1 rack)	B
12" Frozen Pizza (1 rack)	B
2-12" Frozen Pizzas (2 racks)	A & C
Roasting (large cuts of meat, turkeys, etc.)	A, Floor Rack

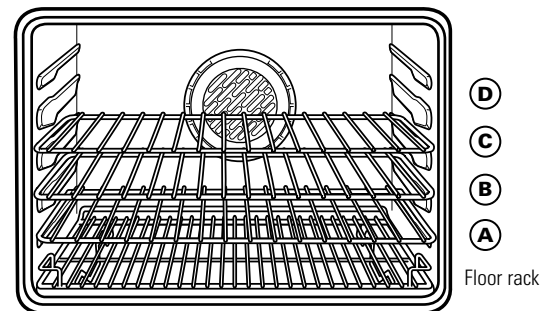

Convection Baking

Wall Oven

1-Rack convection baking

The convection fan circulates the heated air evenly over and around the food using the bake and broil elements.

When convection baking with only 1 rack, place the rack on position B or C at the center of the oven and remove the unused racks. Cook times

may decrease, so food should be checked earlier than package directions to make sure that it does not overcook.

Ideal for cooking large casseroles and lasagna with good results.

Multi-rack convection baking

Because heated air is circulated evenly throughout the oven, foods can be baked with excellent results using multiple racks.

The amount of time required for multi-rack baking may increase slightly for some foods, but overall time is saved because two to three times as much food is cooked at once. Cookies, muffins, biscuits and other quick breads give good results with multi-rack baking.

Many foods may be cooked using the special Convection Floor Rack in combination with the other oven racks. Foods such as chocolate chip and sugar cookies, pizza and pies have shown good results when convection baking using as many as 3 racks plus the floor rack.

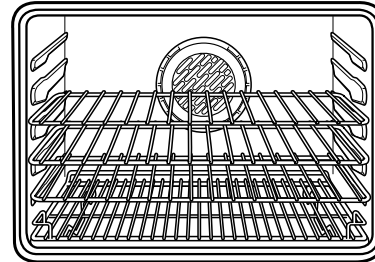

Adapting recipes

You can use your favorite recipes in the convection oven.

When convection baking, reduce baking temperature by 25°F. No temperature adjustment is necessary when convection roasting.

Use pan size recommended.

Some package instructions for frozen casseroles or main dishes have been developed using commercial convection ovens. For best results in this oven, preheat the oven and use the temperature on the package.

Convection Roasting

Wall Oven

How to set the oven for convection roasting

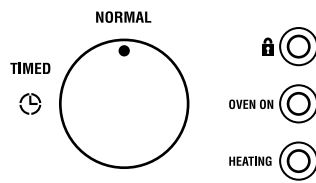

Mode Selector Knob

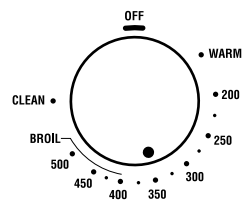

Temperature Control Knob

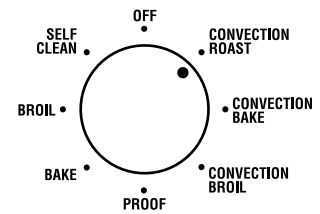

Oven Control Knob

Single oven controls shown.

Convection Roasting is good for roasting large tender cuts of meat, uncovered. Meat and poultry are browned on all sides as if they were cooked on a rotisserie. When set on Convection Roast, the top element and the bake element operate whenever heating. (Fan operates.)

- 1 Turn the Mode Selector Knob to **NORMAL**.
- 2 Using the Temperature Control Knob, set the desired temperature, up to 500°F.
- 3 Turn the Oven Control Knob to **CONVECTION ROAST**.
- 4 Check the food for doneness at the minimum time on the recipe. Cook longer if necessary.
- 5 Turn the Oven Control Knob to **OFF** when convection cooking is finished.

The **OVEN ON** light and the oven interior lights turn on and remain on until the Oven Control Knob has been turned to **OFF**.

The **HEATING** light will come on and stay on until the oven temperature reaches the pre-set temperature. This light will **CYCLE** on and off during the remainder of the cooking process.

NOTE:

- You will hear a convection fan while cooking with this feature.
- A cooling fan will turn on to cool internal parts. This is normal, and the fan may continue to run even after the oven is turned off.

Convection roasting tips

Using the roasting rack provided, heated air will be circulated over, under and around the food being roasted. The heated air seals in juices quickly for a moist and tender interior while, at the same time, creating a rich golden brown exterior.

When you are convection roasting, it is important that you use the broiler pan and grid and the special roasting rack. The pan is used to catch grease spills and the grid is used to prevent grease spatters, while the roasting rack allows the heated air to circulate under the meat and increase browning on the underside of the meat or poultry.

- Place the grid on the broiler pan and put the roasting rack over them, making sure the posts on the roasting rack fit into the holes in the broiler pan.
- Place meat on the roasting rack.
- When convection roasting large cuts of meat, place the pan on either the Convection Floor Rack or a rack in position A.

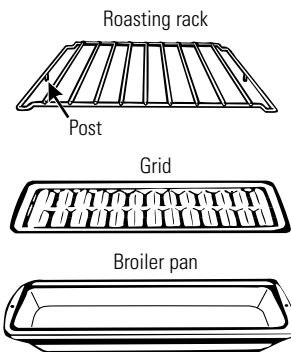

Convection Roasting

Wall Oven

Convection roasting guide

Meats		Minutes/Lb.	Oven Temp.	Internal Temp.	
Beef	Rib, Boneless Rib,	Rare	20–24	325°F	140°F†
	Top Sirloin	Medium	24–28	325°F	160°F
	(3 to 5 lbs.)	Well	28–32	325°F	170°F
	Beef Tenderloin	Rare	10–14	325°F	140°F†
		Medium	14–18	325°F	160°F
Pork	Bone-in, Boneless (3 to 5 lbs.)		23–27	325°F	170°F
	Chops (1/2 to 1" thick)	2 chops	30–35 total	325°F	170°F
		4 chops	35–40 total	325°F	170°F
6 chops		40–45 total	325°F	170°F	
Ham	Canned, Butt, Shank (3 to 5 lbs.) (fully cooked)		14–18	325°F	140°F
Lamb	Bone-in, Boneless (3 to 5 lbs.)		17–20	325°F	160°F
		Medium Well	20–24	325°F	170°F
Seafood	Fish, whole (3 to 5 lbs.)		30–40 total	400°F	
	Lobster Tails (6 to 8 oz. each)		20–25 total	350°F	
Poultry	Whole Chicken (2½ to 3½ lbs.)		24–26	350°F	180°–185°F
	Cornish Hens Unstuffed (1 to 1½ lbs.)		50–55 total	350°F	180°–185°F
	Stuffed (1 to 1½ lbs.)		55–60 total	350°F	180°–185°F
	Duckling (4 to 5 lbs.)		24–26	325°F	180°–185°F
	Turkey, whole*				
	Unstuffed (10 to 16 lbs.)		8–11	325°F	180°–185°F
Unstuffed (18 to 24 lbs.)		7–10	325°F	180°–185°F	
	Turkey Breast (4 to 6 lbs.)		16–19	325°F	170°F

* Stuffed birds generally require 30–45 minutes additional roasting time. Shield legs and breast with foil to prevent over-browning and drying of skin.

† The U.S. Department of Agriculture says "Rare beef is popular, but you should know that cooking it to only 140°F means some food poisoning organisms may survive." (Source: *Safe Food Book. Your Kitchen Guide.* USDA Rev. June 1985.)

Convection Broiling

Wall Oven

How to set the oven for convection broiling

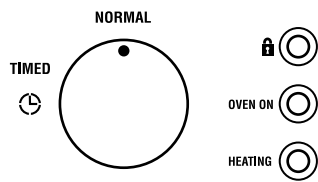

Mode Selector Knob

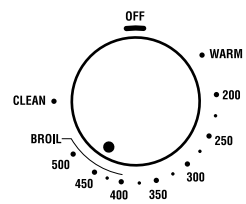

Temperature Control Knob

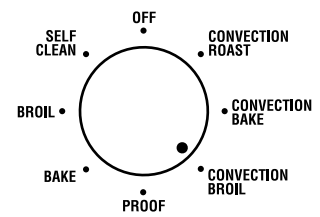

Oven Control Knob

Single oven controls shown.

Convection Broil is good for broiling fish or smaller cuts of meat. The door must be closed when Convection Broiling. When set on Convection Broil, both top elements operate whenever heating. (Fan operates.)

- 1 If the meat has fat or gristle around the edge, cut vertical slashes through both about 2" apart. If desired, the fat may be trimmed, leaving a layer about 1/8" thick.
- 2 Place the meat or fish on the broiler grid in the broiler pan. Always use the grid so that any fat will drip into the broiler pan; otherwise the juices may become hot enough to catch on fire.
- 3 Turn the Mode Selector Knob to **NORMAL**.
- 4 Using the Temperature Control Knob, set the desired temperature, up to 500°F. Most broiling is done at temperatures above 400°F.
- 5 Turn the Oven Control Knob to **CONVECTION BROIL**.
- 6 Turn the food only once during broiling. Check the food for doneness at the minimum time on the recipe. Cook longer if necessary.

Use caution when reaching into the oven during broiling, as areas above the door may be hot.

- 7 Turn the Oven Control Knob to **OFF** when convection cooking is finished.

The **OVEN ON** light and the oven interior lights turn on and remain on until the Oven Control Knob has been turned to **OFF**.

The **HEATING** light will come on and stay on until the oven temperature reaches the pre-set temperature. This light will **CYCLE** on and off during the remainder of the cooking process.

NOTE:

- You will hear a convection fan while cooking with this feature.
- A cooling fan will turn on to cool internal parts. This is normal, and the fan may continue to run even after the oven is turned off.

Aluminum foil

You can use aluminum foil to line the broiler pan and broiler grid. However, you must mold the foil tightly to the grid and cut slits in it just like the grid.

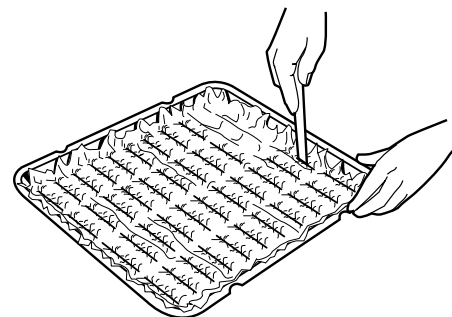

How to set the oven for baking

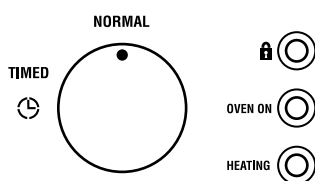

Mode Selector Knob

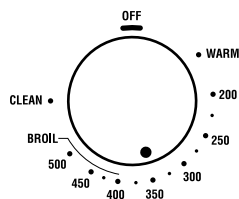

Temperature Control Knob

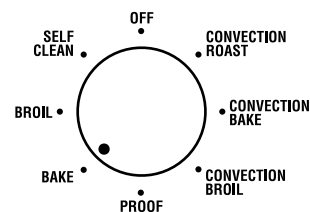

Oven Control Knob

Single oven controls shown.

- 1 Turn the Mode Selector Knob to **NORMAL**.
- 2 Using the Temperature Control Knob, set the desired temperature, up to 500°F.
- 3 Turn the Oven Control Knob to **BAKE**.
- 4 Check the food for doneness at the minimum time on the recipe. Cook longer if necessary.
- 5 Turn the Oven Control Knob to **OFF** when baking is finished.

A cooling fan will automatically turn on to cool internal parts. This is normal, and the fan may continue to run even after the oven is turned off.

The **OVEN ON** light and the oven interior lights turn on and remain on until the Oven Control Knob has been turned to **OFF**.

The **HEATING** light will come on and stay on until the oven temperature reaches the pre-set temperature. When the light goes off, foods with recipes requiring a preheated oven should

be placed in the oven. This light will **CYCLE** on and off during the remainder of the cooking process.

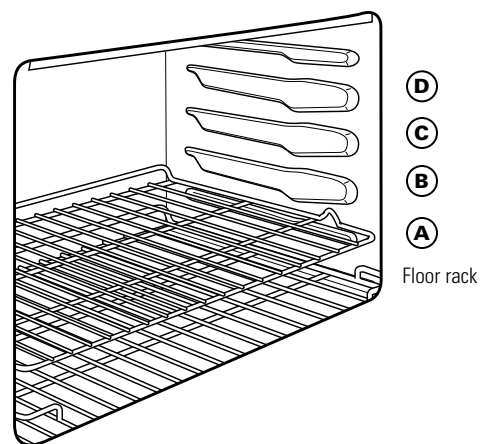

Floor rack

NOTE: When roasting, use the Convection Roast feature.

Type of Food	Rack Position
Angel food cake	A
Biscuits or muffins	B or C
Cookies or cupcakes	B or C
Brownies	B or C
Layer cakes	B or C
Bundt or pound cakes	A
Pies or pie shells	A or C
Single Pie	B
Frozen pies	B (on cookie sheet)
Casseroles	B or C
Roasting	Use Convection Roast

How to set the oven for proofing

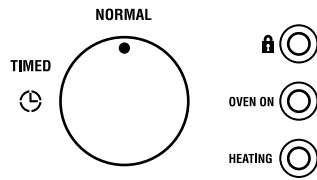

Mode Selector Knob

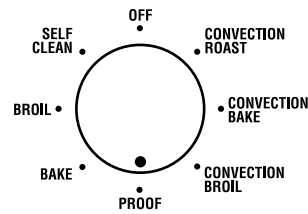

Oven Control Knob

Single oven controls shown.

The proofing feature maintains a warm environment useful for rising yeast-leavened products.

Place the covered dough in a dish in the oven on rack A.

- 1 Turn the Mode Selector Knob to **NORMAL**.

NOTE: For best results, cover the dough with a cloth or with greased plastic wrap (the plastic may need to be anchored underneath the front of the container so the oven fan will not blow it off).

- 2 Turn the Oven Control Knob to **PROOF**.

The Temperature Control Knob does not affect the proof temperature.

The **OVEN ON** light and the oven interior lights turn on and remain on until the Oven Control Knob has been turned to **OFF**.

NOTE: The **HEATING** light does not come on during a **PROOF** operation.

- 3 Set the minute timer for the minimum proof time.
 - 4 When proofing is finished, turn the Oven Control Knob to **OFF**.
- To avoid lowering the oven temperature and lengthening proofing time, do not open the oven door unnecessarily.
 - Check bread products early to avoid over-proofing.

NOTE: Do not use the proofing mode for warming food or keeping food hot. The proofing oven temperature is not hot enough to hold foods at safe temperatures.

How to set the oven for broiling

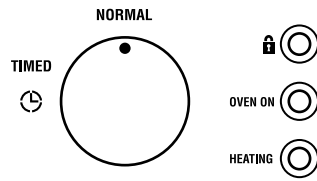

Mode Selector Knob

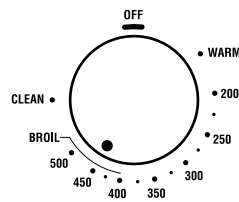

Temperature Control Knob

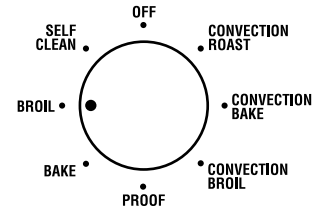

Oven Control Knob

Single oven controls shown.

- 1 If the meat has fat or gristle around the edge, cut vertical slashes through both about 2" apart. If desired, the fat may be trimmed, leaving a layer about 1/8" thick.
- 2 Place the meat or fish on the broiler grid in the broiler pan. Always use the grid so that any fat will drip into the broiler pan; otherwise the juices may become hot enough to catch on fire.
- 3 Position a rack on the recommended rack position as suggested in the Broiling Guide.
- 4 Leave the door open to the broil stop position. The door will stay open by itself, yet the proper temperature is maintained in the oven.
- 5 Turn the Mode Selector Knob to **NORMAL**.
- 6 Turn the Temperature Control Knob to the desired setting, up to 500°F. Most broiling is done at temperatures above 400°F.
- 7 Turn the Oven Control Knob to **BROIL**.
- 8 When broiling is finished, turn the Oven Control Knob to **OFF**.

NOTE: A cooling fan will turn on to cool internal parts. This is normal, and the fan may continue to run even after the oven is turned off.

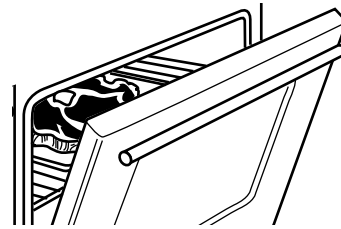

The oven door has a broil stop position.

The **OVEN ON** light and the oven interior lights turn on and remain on until the oven control knob has been turned to **OFF**.

The **HEATING** light turns on.

The broiler does not need to be preheated for most broiling. However, foods that cook quickly, such as thin strips of meat or fish may require a short preheating period of 2 to 3 minutes to allow the food surface to brown in the same time the food takes to be cooked throughout.

Turn the food only once during broiling. Time the foods for the first side according to the Broiling Guide.

Use caution when reaching into the oven during broiling as areas above the door may be hot.

Aluminum foil

You can use aluminum foil to line the broiler pan and broiler grid. However, you must mold the foil tightly to the grid and cut slits in it just like the grid.

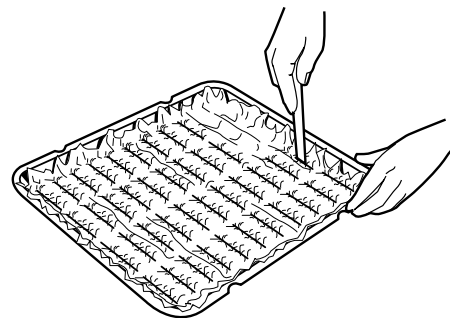

Broiling

Wall Oven

Broiling guide

The size, weight, thickness, starting temperature and your preference for doneness will affect broiling times. This guide is based on meats at refrigerator temperature.

The U.S. Department of Agriculture says "Rare beef is popular, but you should know that cooking it to only 140°F means some food poisoning organisms may survive." (Source: *Safe Food Book, Your Kitchen Guide*. USDA Rev. June 1985.)

Food	Quantity/ Thickness	Rack Position	1st Side Minutes	2nd Side Minutes	Comments
Bacon	1/2 lb. (about 8 thin slices)	C	4½	4½	Arrange in single layer.
Ground Beef Well Done	1 lb. (4 patties) 1/2 to 3/4" thick	C	10	7	Space evenly. Up to 8 patties take about the same time.
Beef Steaks Rare Medium Well Done	1" thick (1 to 1½ lbs.)	C C C	6 8 12	5 6 11	Steaks less than 1" thick cook through before browning. Pan frying is recommended.
Rare† Medium Well Done	1½" thick (2 to 2½ lbs.)	C C C	10 15 25	7-8 14-16 20-25	Slash fat.
Chicken	1 whole (2 to 2½ lbs.), split lengthwise	A	35	10-15	Reduce time about 5 to 10 minutes per side for cut-up chicken. Brush each side with melted butter. Broil skin-side-down first.
Bakery Products Bread (Toast) Toaster Pastries English Muffins	2 to 4 slices 1 pkg. (2) 2 (split)	C C C	1½-2 1½-2 3-4	1/2 1/2	Space evenly. Place English muffins cut-side-up and brush with butter, if desired.
Lobster Tails	2-4 (6 to 8 oz. each)	B	13-16	<i>Do not turn over.</i>	Cut through back of shell. Spread open. Brush with melted butter before broiling and after half of broiling time.
Fish	1-lb. fillets 1/4 to 1/2" thick	C	5	5	Handle and turn very carefully. Brush with lemon butter before and during cooking, if desired. Preheat broiler to increase browning.
Ham Slices (precooked)	1" thick	B	8	8	Increase time 5 to 10 minutes per side for 1½" thick or home cured.
Pork Chops Well Done	2 (1/2" thick) 2 (1" thick), about 1 lb.	C B	10 13	10 13	Slash fat.
Lamb Chops Medium Well Done Medium Well Done	2 (1" thick), 10 to 12 oz. 2 (1½" thick), about 1 lb.	C C C B	10 12 14 17	9 10 12 12-14	Slash fat.
Wieners, Sausages, Bratwurst	1-lb. pkg. (10)	C	6	1-2	If desired, split in half lengthwise; cut into 5 to 6" pieces.

Timed cooking (immediate start and automatic stop)

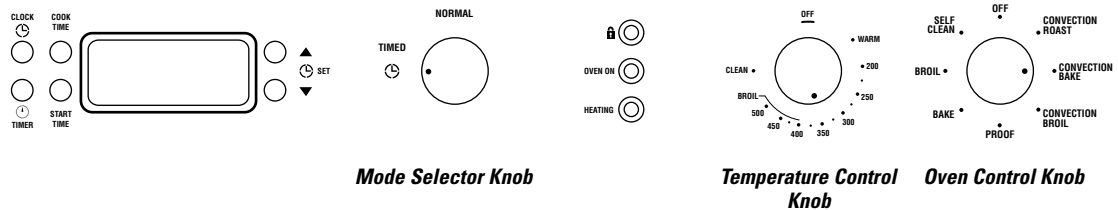

Single oven controls shown set for convection baking.

Timed cooking allows you to set the oven to cook for a selected length of time and turn off automatically. On double oven models, you will not be able to set a timed cooking or cleaning function in both ovens at the same time.

To set the oven to turn on immediately:

NOTE: Before beginning, make sure the clock shows the correct time of day.

To avoid possible burns, place the racks in the correct position before you turn the oven on.

- 1 Turn the Mode Selector Knob to **TIMED** (on double oven models, select **UPPER TIMED** or **LOWER TIMED**, depending on the oven you are using).
- 2 Turn the Oven Control Knob to the desired cooking function.
- 3 Using the Temperature Control Knob, set the desired temperature, up to 500°F.

NOTE: The **OVEN ON** & **HEATING** lights and the oven interior lights will not turn on until the oven starts heating.

- 4 Press the **COOK TIME** button.

NOTE: If your recipe requires preheating, you may need to add additional time to the length of cooking time (approximately 15 minutes).

- 5 Press the increase “▲” or decrease “▼” button to set the cooking time. (The maximum cooking time is 11 hours and 50 minutes. The minimum cooking time is 1 minute.)

If the increase “▲” or decrease “▼” button is not pressed within 5 seconds of pressing the **COOK TIME** button, you will need to press **COOK TIME** again.

The display will show **COOK** and the cooking time countdown.

The oven will continue to cook for the programmed amount of time, then turn off automatically.

- 6 At the end of timed cooking, the word **COOK** will blink in the display and the end of cycle tone will sound. To clear the end of cycle tone, press any button. Turn the Oven Control Knobs to **OFF** and the Mode Selector Knob to **NORMAL**.

NOTE:

- You will hear a convection fan while cooking with convection features.
- A cooling fan will turn on to cool internal parts. This is normal, and the fan may continue to run even after the oven is turned off.
- The **WARM** temperature setting of this oven is available to keep hot cooked foods warm. Food kept in the oven longer than two hours at these low temperatures may not be safe to eat.
- Foods that spoil easily, such as milk, eggs, fish, stuffings, poultry and pork, should not be allowed to sit for more than one hour before or after cooking. Room temperature promotes the growth of harmful bacteria. Be sure the oven light is off because heat from the bulb will speed harmful bacteria growth.

Timed cooking (delayed start and automatic stop)

Timed cooking allows you to set the oven to cook for a selected length of time and turn off automatically. On double oven models, you will not be able to set a timed cooking or cleaning function in both ovens at the same time.

To delay the start of cooking:

NOTE: Before beginning, make sure the clock shows the correct time of day.

To avoid possible burns, place the racks in the correct position before you turn the oven on.

- 1 Turn the Mode Selector Knob to TIMED (on double oven models, select UPPER TIMED or LOWER TIMED, depending on the oven you are using).
- 2 Turn the Oven Control Knob to the desired cooking function.
- 3 Using the Temperature Control Knob, set the desired temperature, up to 500°F.
- 4 Press the START TIME button.
- 5 Press the increase “▲” or decrease “▼” button to set the time of day you want the oven to turn on and start cooking.

If the increase “▲” or decrease “▼” button is not pressed within 5 seconds of pressing the START TIME button, you will need to press START TIME again.

- 6 Press the COOK TIME button.
- 7 Press the increase “▲” or decrease “▼” button to set the cooking time. (The maximum cooking time is 11 hours and 50 minutes. The minimum cooking time is 1 minute.)

If the increase “▲” or decrease “▼” button is not pressed within 5 seconds of pressing the COOK TIME button, you will need to press COOK TIME again.

NOTE: The OVEN ON & HEATING lights and the oven interior lights will not turn on until the oven starts heating.

The display will return to the time of day and show the word DELAY. When the start time is reached, the display will show the word COOK and the cooking time countdown.

At this time, the OVEN ON light and the oven interior lights turn on and remain on until the end of timed cooking.

The oven will continue to cook for the programmed amount of time, then turn off automatically.

- 8 At the end of timed cooking, the word COOK will blink in the display and an end of cycle tone will sound. To clear the end of cycle tone, press any button. Turn the Oven Control Knob to OFF and the Mode Selector Knob to NORMAL.

NOTE:

- You will hear a convection fan while cooking with convection features.
- A cooling fan will turn on to cool internal parts. This is normal, and the fan may continue to run even after the oven is turned off.
- The WARM temperature setting of this oven is available to keep hot cooked foods warm. Food kept in the oven longer than two hours at these low temperatures may not be safe to eat.
- Foods that spoil easily, such as milk, eggs, fish, stuffings, poultry and pork, should not be allowed to sit for more than one hour before or after cooking. Room temperature promotes the growth of harmful bacteria. Be sure the oven light is off because heat from the bulb will speed harmful bacteria growth.

Adjust the Oven Thermostat

Wall Oven

Do it yourself!

You may feel that your new oven cooks differently than the one it replaced. We recommend that you use your new oven for a few weeks to become more familiar with it, following the times given in your recipes as a guide.

If you think your new oven is too hot or too cool, you can adjust the thermostat yourself. If you think it is too hot, adjust the thermostat to make it cooler. If you think it is too cool, adjust the thermostat to make it hotter.

We do not recommend the use of thermometers, such as those found in grocery stores, to check the temperature setting of your new oven. These thermometers may vary 20–40 degrees.

To adjust the oven thermostat

- 1 Pull the Temperature Control Knob off the shaft, look at the back of the knob and note the current setting *before* making any adjustments.
- 2 Loosen both screws on the back of the knob.
- 3 To **increase** the oven temperature, move the index mark one notch toward the words “**MAKE HOTTER.**”

To **decrease** the oven temperature, move the index mark one notch toward the words “**MAKE COLDER.**”

Each notch changes the temperature by 10 degrees Fahrenheit.

- 4 Tighten the screws.
- 5 Replace the knob, matching the flat area of the knob to the shaft.

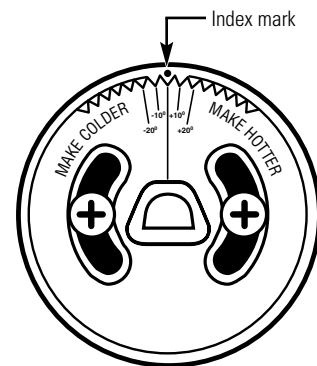

Back of the Temperature Control Knob

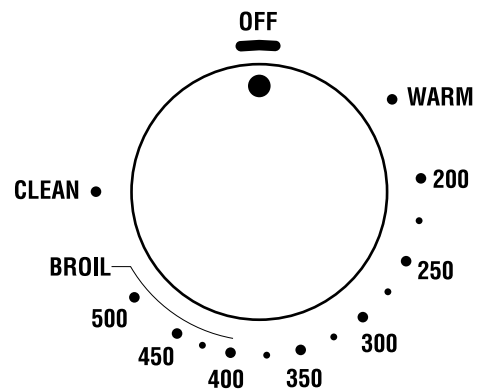

Front of the Temperature Control Knob
(knob appearance may vary)

Self-Cleaning Oven

Wall Oven

Before a clean cycle

The oven must be completely cool in order to set the self-clean cycle.

We recommend venting with an open window or using a ventilation fan or hood during the first self-clean cycle.

Clean soil from the frame around the oven door and outside the door gasket. These areas must be cleaned by hand.

Do not clean the door gasket by hand as this could damage it.

Wipe up excess grease and other food spills with a damp cloth. This will minimize the amount of smoke created during self-cleaning.

Remove all cookware, broiler pan, grid and any aluminum foil from the oven.

The oven racks may be left in the oven during the self-clean cycle.

Make sure the oven light lens and lens frame are in place.

Do not use commercial oven cleaners or oven protectors in or near the self-cleaning oven.

IMPORTANT: The health of some birds is extremely sensitive to the fumes given off during the self-cleaning cycle of any oven. Move birds to another well-ventilated room.

How to set the oven for cleaning

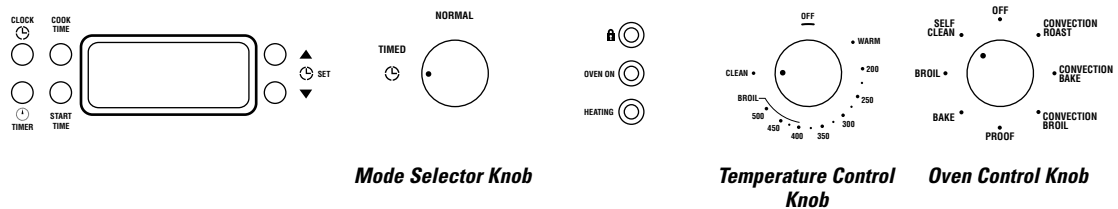

Single oven controls shown set for cleaning.

You can set the oven to turn on immediately, clean for a selected length of time and turn off automatically. On double oven models, you will not be able to set a timed cooking or cleaning function in both ovens at the same time.

NOTE: Before beginning, make sure the clock shows the correct time of day.

- 1 Turn the Mode Selector Knob to TIMED (on double oven models, select UPPER TIMED or LOWER TIMED, depending on the oven you are cleaning).
- 2 Turn the Oven Control Knob to SELF CLEAN.
- 3 Turn the Temperature Control Knob to CLEAN.

Clean time is normally 3 hours. You can change the clean time to any time between 2 and 4 hours, depending on the amount of soil in your oven.

If your oven is connected to a 208V electrical supply, we recommend that you set your clean time for 4 hours.

- 4 Press the COOK TIME button if a time other than 3 hours is needed.
- 5 Press the increase “▲” or decrease “▼” button to set the cleaning time.

If the increase “▲” or decrease “▼” button is not pressed within 5 seconds of pressing the COOK TIME button, you will need to press COOK TIME again.

The display will show CLEAN and the clean time remaining.

As the oven heats to the clean temperature, the door will lock automatically. The locked door, HEATING and the oven OVEN ON indicator lights turn on.

- 6 After the clean cycle is complete, the oven has cooled and the locked door indicator light is off, turn the Oven Control Knobs to OFF and the Mode Selector Knob to NORMAL.

How to delay the start of cleaning

You can set the oven to delay the start of cleaning, clean for a selected length of time and turn off automatically. On double oven models, you will not be able to set a timed cooking or cleaning function in both ovens at the same time

NOTE: Before beginning, make sure the clock shows the correct time of day.

- ⑦ Turn the Mode Selector Knob to TIMED (on double oven models, select UPPER TIMED or LOWER TIMED, depending on the oven you are cleaning).
- ② Turn the Oven Control Knob to SELF CLEAN.
- ③ Turn the Temperature Control Knob to CLEAN.
- ④ Press the START TIME button.
- ⑤ Press the increase “▲” or decrease “▼” button to set the time of day you want the oven to turn on and start cleaning.

If the increase “▲” or decrease “▼” button is not pressed within 5 seconds of pressing the START TIME button, you will need to press START TIME again.

Clean time is normally 3 hours. You can change the clean time to any time between 2 and 4 hours, depending on the amount of soil in your oven.

If your oven is connected to a 208V electrical supply, we recommend that you set your clean time for 4 hours.

- ⑥ Press the COOK TIME button if a time other than 3 hours is needed.
- ⑦ Press the increase “▲” or decrease “▼” button to set the cleaning time.

If the increase “▲” or decrease “▼” button is not pressed within 5 seconds of pressing the COOK TIME button, you will need to press COOK TIME again.

The display will return to the time of day and show the word DELAY. When the start time is reached, the display will show the word CLEAN and the clean time remaining.

As the oven heats to the clean temperature, the door will lock automatically. The locked door, HEATING and OVEN ON indicator lights turn on.

- ⑧ After the clean cycle is complete, the oven has cooled and the locked door indicator light is off, turn the Oven Control Knobs to OFF and the Mode Selector Knob to NORMAL.

After a clean cycle

IMPORTANT: It will be necessary to grease all rack side edges with a light coating of vegetable oil after cleaning them by hand or in the oven. This will help maintain the ease of sliding the racks in and out of the oven.

If white spots remain, remove them with warm sudsy water and rinse thoroughly with a vinegar and water mixture. These deposits are usually a salt residue that cannot be removed by the clean cycle.

If the oven is not clean after one clean cycle, repeat the cycle.

You may notice some white ash in the oven. Wipe it up with a damp cloth after the oven cools.

Control panel and knobs

Clean up spatters with a damp cloth. Remove heavier soil with warm, soapy water.

Do not use abrasives of any kind on the control panel or knobs.

The control knobs may be removed for easier cleaning. To remove a knob, pull it straight off the stem. Wash the knobs in soap and water but do not soak.

IMPORTANT: Make sure to replace the knobs in their original positions after cleaning so the Temperature Control Knob is placed on the correct stem.

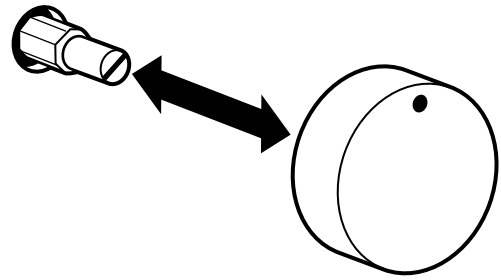

Oven heating elements

Do not clean the broil element. Any soil will burn off when the element is heated.

The bake element is not exposed and is under the oven floor. If spillovers, residue or ash accumulate on the oven floor, wipe up before self-cleaning.

Oven racks

The racks and Convection Floor Rack may remain in the oven during the self-cleaning cycle without being damaged.

IMPORTANT: It will be necessary to grease all rack side edges with a light coating of vegetable oil after cleaning them by hand or in the oven. This will help maintain the ease of sliding the racks in and out of the oven.

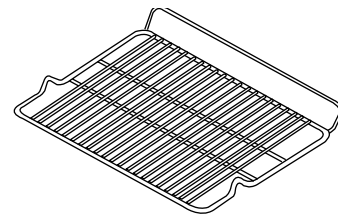

Broiler pan, grid and Convection Roasting Rack

After broiling, remove the broiler pan and grid from the oven. Remove the grid from the pan. Carefully pour out the grease from the pan into a proper container. Wash and rinse the broiler pan and grid in hot water with a soap-filled or plastic scouring pad.

If food has burned on, sprinkle the grid with detergent while hot and cover with wet paper towels or a dishcloth. Soaking the pan will remove burned-on foods.

The broiler pan and grid may be cleaned with a commercial oven cleaner.

The broiler pan, grid and Convection Roasting Rack can also be cleaned in the dishwasher.

Do not store a soiled broiler pan, grid or Convection Roasting Rack anywhere in the oven.

CAUTION: Do not clean the broiler pan, grid or Convection Roasting Rack in a self-cleaning oven.

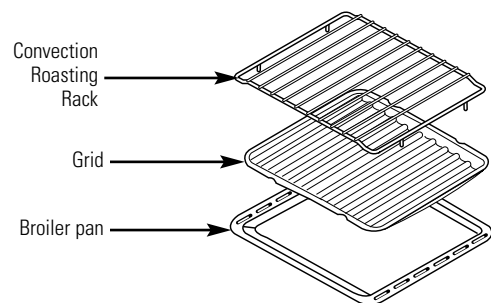

Oven lights

Each oven is equipped with two halogen lights located on the back wall of the oven. The lights come on when the door is opened or when the oven is in a cooking cycle. The oven lights do not come on during self-cleaning.

Each light assembly consists of a removable lens frame, a removable lens, a light bulb and a bulb socket that is fixed in place.

CAUTION: Before replacing the bulb, disconnect electrical power to the oven at the main fuse or circuit breaker panel.

Be sure to let the light cover and bulb cool completely.

For your safety, do not touch a hot bulb with bare hands or a damp cloth.

To remove:

- ① Remove the lens frame by unscrewing the screw.
- ② Remove the lens.
- ③ Using gloves or a dry cloth, remove the bulb by pulling it straight out.

To replace:

- ① Use a new 12-volt Halogen bulb, size T3, G4 pins, not to exceed 20 watts.

NOTE: Higher wattage bulbs will damage your oven.

- ② Using gloves or a dry cloth, remove the bulb from its packaging. Do not touch the bulb with bare fingers.
- ③ Push the bulb straight into the receptacle all the way.
- ④ Replace the lens, making sure that it is firmly pressed in place.
- ⑤ Replace the lens frame and fasten in place with the screw. The lens and lens frame must be in place when using the oven.

For improved lighting inside the oven, clean the glass cover frequently using a wet cloth. This should be done when the oven is completely cool.

- ⑥ Reconnect electrical power to the oven.

Replacement bulbs may be purchased by calling 800.626.2002. Order Part Number WB08X10002.

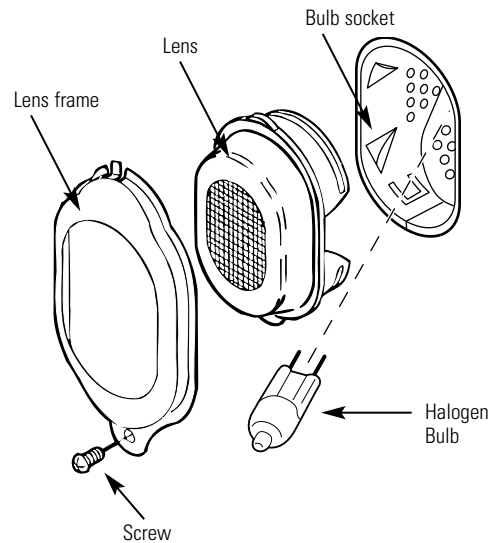

To clean the door

Inside of the door:

- Because the area inside the gasket is cleaned during the self-clean cycle, you do not need to clean this by hand. Any soap left on the liner causes additional stains when the oven is heated so be sure to rinse thoroughly.
- The area outside the gasket can be cleaned with a soap-filled scouring pad.
- **Do not rub or clean the door gasket**—the fiberglass material of the gasket has an extremely low resistance to abrasion. An intact and well-fitting oven door gasket is essential for energy-efficient oven operation and good baking results. If you notice the gasket becoming worn, frayed or damaged in any way or if it has become displaced on the oven, you should have it replaced.

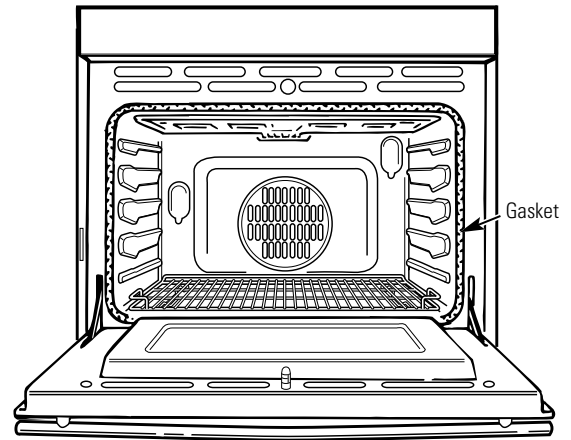

Outside of the door:

Painted Surfaces (on some models)

Clean these with soap and water or a vinegar and water solution.

Do not use commercial oven cleaners, cleaning powders, steel wool or harsh abrasives on any painted surface.

Stainless Steel Surfaces (on some models)

Do not use a steel-wool pad; it will scratch the surface.

To clean the stainless steel surface, use CERAMA BRYTE® Stainless Steel Appliance Cleaner. Apply with a damp cloth, clean the surface and wipe with a dry cloth or paper towel to a high gloss. Repeat if necessary.

To order

To order CERAMA BRYTE® Stainless Steel Appliance Cleaner, please call our toll-free number:

National Parts Center **800.626.2002**

CERAMA BRYTE®
Stainless Steel Appliance
Cleaner # **PM10X311**

The Problem Solver

Wall Oven

*Questions?
Use this
problem
solver!*

PROBLEM	POSSIBLE CAUSE
OVEN WILL NOT WORK	<ul style="list-style-type: none"> ● A fuse in your home may be blown or the circuit breaker tripped. ● The oven controls are not properly set. ● The oven controls are set for cleaning. If necessary, allow the oven to cool then open the door. ● Make sure the Mode Selector Knob is set to NORMAL. ● If the oven was on during a power outage, turn the Oven Control Knob off, then back to the desired function to restart the oven.
OVEN LIGHT(S) DO NOT WORK	<ul style="list-style-type: none"> ● The light bulb is loose or defective. Tighten or replace the bulb. ● The oven is self-cleaning or in a "TIMED" delay mode. The oven lights do not come on during self-cleaning or during a "TIMED" delay mode until the oven begins heating.
FOOD DOES NOT BAKE OR ROAST PROPERLY	<ul style="list-style-type: none"> ● The oven controls are improperly set. See the "How to set your oven for baking or roasting" section. ● Oven not preheated for a long enough time (use at least 15 minutes). ● Incorrect cookware or cookware of improper size being used. See the "How to set your oven for baking or roasting" section. ● Racks in the wrong position. See the "How to set the oven for baking or roasting" section. ● Use a foil tent to slow down browning during roasting.
FOOD DOES NOT BROIL PROPERLY	<ul style="list-style-type: none"> ● The oven controls are not set at BROIL. Turn both the Oven Control and Oven Temperature Knob to BROIL. ● Improper rack position being used. See the Broiling Guide. ● Food is being cooked in a hot pan. ● Cookware is not suited for broiling. Use the broiling pan and grid that came with your oven. ● Aluminum foil used on the broiling pan and grid has not been fitted properly and slit as recommended. ● In some areas the power (voltage) may be low. Preheat the broil element for 10 minutes. Broil for the longest period of time recommended in the Broiling Guide.
OVEN WILL NOT SELF CLEAN	<ul style="list-style-type: none"> ● The oven temperature is too high to set a self-clean operation. Allow the oven to cool to room temperature and reset the controls. ● The controls are not properly set. Be sure the Mode Selector Knob is set in the TIMED position.
"CRACKING" OR "POPPING" SOUND DURING CLEANING	<ul style="list-style-type: none"> ● This is normal. This is the sound of the metal heating and cooling during both the cooking and cleaning functions.
EXCESSIVE SMOKING OCCURS DURING CLEANING	<ul style="list-style-type: none"> ● Excessive soil. Turn the Oven Control Knobs to OFF. Open the windows to rid the room of smoke. Wait until the locked door indicator light goes off. Wipe up excess soil and reset the clean cycle.
OVEN NOT CLEAN AFTER A CLEAN CYCLE	<ul style="list-style-type: none"> ● The oven was heavily soiled. Clean up heavy spillovers before starting the clean cycle. Heavily soiled ovens may need to self-clean again. ● Oven is connected to a 208V electrical supply. Set your cleaning time for 4 hours. ● The oven controls are not properly set. Be sure the Mode Selector Knob is set in the TIMED position. See the "Self-Cleaning" section.
OVEN RACKS ARE DIFFICULT TO SLIDE	<ul style="list-style-type: none"> ● The racks were cleaned in a self-clean cycle. Apply a small amount of vegetable oil to a paper towel and wipe the edges of the oven racks with the paper towel. Do not spray with Pam® or other lubricant sprays.

With the purchase of your new Monogram appliance, receive the assurance that if you ever need information or assistance from GE, we will be there. All you have to do is call—toll-free!

GE Answer Center®

***In the USA:
800.626.2000***

Whatever your question about any Monogram major appliance, GE Answer Center® information service is available to help. Your call—and your question—will be answered promptly and courteously. And you can call any time. GE Answer Center® service is open 24 hours a day, 7 days a week.

OR

Visit our Website at: www.monogram.com

In Canada, call 1.888.880.3030.

In-Home Repair Service

***In the USA:
800.444.1845***

***In Canada:
1.888.880.3030***

A GE consumer service professional will provide expert repair service, scheduled at a time that's convenient for you. Many GE Consumer Service company-operated locations offer you service today or tomorrow, or at your convenience (7:00 a.m. to 7:00 p.m. weekdays, 9:00 a.m. to 2:00 p.m. Saturdays). Our factory-trained technicians know your appliance inside and out—so most repairs can be handled in just one visit.

For Customers With Special Needs...

***In the USA:
800.626.2000***

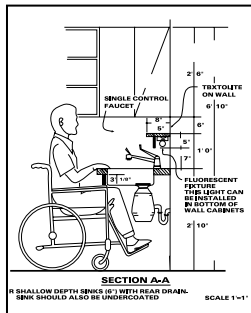

GE offers Braille controls for a variety of GE appliances, and a brochure to assist in planning a barrier-free kitchen for persons with limited mobility.

Consumers with impaired hearing or speech who have access to a TDD or a conventional teletypewriter may call 800.TDD.GEAC (800.833.4322) to request information or service.

Service Contracts

***In the USA:
800.626.2224***

***In Canada:
1.888.880.3030***

You can have the secure feeling that GE Consumer Service will still be there after your warranty expires. Purchase a GE contract while your warranty is still in effect and you'll receive a substantial discount. With a multiple-year contract, you're assured of future service at today's prices.

Parts and Accessories

***In the USA:
800.626.2002***

***In Canada:
1.888.880.3030***

Individuals qualified to service their own appliances can have parts or accessories sent directly to their home. The GE parts system provides access to over 47,000 parts...and all GE Genuine Renewal Parts are fully warranted. VISA, MasterCard and Discover cards are accepted.

User maintenance instructions contained in this manual cover procedures intended to be performed by any user. Other servicing generally should be referred to qualified service personnel. Caution must be exercised, since improper servicing may cause unsafe operation.

YOUR MONOGRAM WALL OVEN WARRANTY

Staple sales slip or cancelled check here. Proof of original purchase date is needed to obtain service under warranty.

WHAT IS COVERED

From the Date of the Original Purchase

FULL ONE-YEAR WARRANTY

For one year from date of original purchase, we will provide, free of charge, parts and service labor in your home to repair or replace **any part of the oven** that fails because of a manufacturing defect.

This warranty is extended to the original purchaser and any succeeding owner for products purchased for ordinary home use in the 48 mainland states, Hawaii, Washington, D.C. or Canada. In Alaska the warranty is the same except that it is LIMITED because you must pay to ship the product to the service shop or for the service technician's travel costs to your home.

All warranty service will be provided by our Factory Service Centers or by our authorized Customer Care® servicers during normal working hours.

Should your appliance need service, during warranty period or beyond, in the USA call 800.444.1845. In Canada: 888.880.3030.

WHAT IS NOT COVERED

- Service trips to your home to teach you how to use the product.
 - Replacement of house fuses or resetting of circuit breakers.
 - Damage to the product caused by accident, fire, floods or acts of God.
 - Damage after delivery.
 - Failure of the product if it is used for other than its intended purpose or used commercially.
 - Improper installation, delivery or maintenance.
- If you have an installation problem, contact your dealer or installer. You are responsible for providing adequate electrical, gas, exhausting and other connecting facilities as described in the Installation Instructions provided with the product.
- Incidental or consequential damage caused by possible defects with this appliance.

Some states/provinces do not allow the exclusion or limitation of incidental or consequential damages, so the above limitation or exclusion may not apply to you. This warranty gives you specific legal rights, and you may also have other rights which vary from state to state/province to province. To know what your legal rights are in your state/province, consult your local or state/provincial consumer affairs office or your state's Attorney General.

**Warrantor in USA: General Electric Company,
Louisville, KY 40225**

Warrantor in Canada: Camco Inc.



Monogram®

GE Consumer & Industrial
Louisville, KY 40225

©2005 GE Company

49-80294

01-05 JR
Printed in Italy

Free Manuals Download Website

<http://myh66.com>

<http://usermanuals.us>

<http://www.somanuals.com>

<http://www.4manuals.cc>

<http://www.manual-lib.com>

<http://www.404manual.com>

<http://www.luxmanual.com>

<http://aubethermostatmanual.com>

Golf course search by state

<http://golfingnear.com>

Email search by domain

<http://emailbydomain.com>

Auto manuals search

<http://auto.somanuals.com>

TV manuals search

<http://tv.somanuals.com>