

GE Monogram®

Use and Care Guide

Downdraft

36" Gas Cooktop

*Introduction*

Your new Monogram cooktop makes an eloquent statement of style, convenience and kitchen planning flexibility. Whether you chose it for its purity of design, assiduous attention to detail—or for both of these reasons—you’ll find that your Monogram cooktop’s superior blend of form and function will delight you for years to come.

Your Monogram cooktop was designed to provide the flexibility to blend in with your kitchen cabinetry. Its sleek design can be beautifully integrated into the kitchen.

The information on the following pages will help you operate and maintain your cooktop properly.

If you have any other questions—please call the GE Answer Center® 800.626.2000.

*Contents*

**Care and Cleaning**

Burner Assembly ..... 11  
 Burner Grates ..... 11  
 Control Knobs ..... 10  
 Glass Cooktop ..... 10  
 Grease Filters ..... 10

**Consumer Services**

Important Phone Numbers ..... 13  
 Model and Serial Number ..... 3, 16  
 Before You Call for Service ..... 12  
 Product Registration ..... 3, 15, 16  
 Safety Instructions ..... 2, 4, 5  
 Warranty ..... 14

**Using Your Cooktop**

Controls ..... 7  
 Cooktop Vent System ..... 9  
 Cookware ..... 7, 8  
 Features ..... 6  
 Flame Size ..... 7

**WARNING: If the information in this guide is not followed exactly, a fire or explosion may result causing property damage, personal injury or death.**

- Do not store or use gasoline or other flammable vapors and liquids in the vicinity of this or any other appliance.
- **WHAT TO DO IF YOU SMELL GAS**
  - Do not try to light any appliance.
  - Do not touch any electrical switch; do not use any phone in your building.
  - Immediately call your gas supplier from a neighbor’s phone. Follow the gas supplier’s instructions.
  - If you cannot reach your gas supplier, call the fire department.
- Installation and service must be performed by a qualified installer, service agency or the gas supplier.



---

*Before  
using  
your  
cooktop*

Read this guide carefully. It is intended to help you operate and maintain your new cooktop properly.

Keep it handy for answers to your questions.

If you don't understand something or need more help, call:

**GE Answer Center®**  
**800.626.2000**  
**24 hours a day, 7 days a week**

---

*Write  
down the  
model &  
serial  
numbers*

You'll find them on a label located on the underside of the cooktop.

These numbers are also on the Consumer Product Ownership Registration Card included in this guide.

**Before sending in this card, please write these numbers here:**

\_\_\_\_\_  
Model Number

\_\_\_\_\_  
Serial Number

Use these numbers in any correspondence or service calls concerning your cooktop.

---

*If you  
received a  
damaged  
cooktop*

Immediately contact the dealer (or builder) that sold you the cooktop.

---

*Save time  
& money*

Before you request service, check the Before you call for service section in the back of this guide.

It lists causes of minor operating problems that you can correct yourself.

---

*If you  
need  
service*

To obtain service, see the Consumer Services page in the back of this guide.

We're proud of our service and want you to be pleased. If for some reason you are not happy with the service you receive, here are three steps to follow for further help.

FIRST, contact the people who serviced your appliance. Explain why you are not pleased. In most cases, this will solve the problem.

NEXT, if you are still not pleased, write all the details—including your phone number—to:

Manager, Consumer Relations  
GE Appliances  
Appliance Park  
Louisville, KY 40225

FINALLY, if your problem is still not resolved, write:

Major Appliance Consumer  
Action Program  
20 North Wacker Drive  
Chicago, IL 60606

# IMPORTANT SAFETY INSTRUCTIONS

## SAFETY PRECAUTIONS

### IMPORTANT SAFETY NOTICE:

- **The California Safe Drinking Water and Toxic Enforcement Act** requires the Governor of California to publish a list of substances known to the state to cause cancer, birth defects or other reproductive harm, and requires businesses to warn customers of potential exposure to such substances.
- **Gas appliances can cause minor exposure to four of these substances**, namely benzene, carbon monoxide, formaldehyde and soot, caused primarily by the incomplete combustion of natural gas or LP fuels. Properly adjusted burners, indicated by a bluish rather than a yellow flame, will minimize incomplete combustion. Exposure to these substances can be minimized further by venting with an open window or using the ventilation fan.
- **When you get your cooktop, have the installer show you the location of the gas cut-off valve and how to shut it off if necessary.**
- **Have your cooktop installed and properly grounded by a qualified installer**, in accordance with the installation instructions. Any adjustment and service should be performed only by qualified gas range installers or service technicians.
- **Plug your cooktop into a 120-volt grounded outlet only.** Do not remove the round grounding prong from the plug. If in doubt about the grounding of the home electrical system, it is your personal responsibility and obligation to have an ungrounded outlet replaced with a properly-grounded three-prong outlet in accordance with the National Electrical Code. Do not use an extension cord with this appliance.
- **Be sure all packing materials are removed from the cooktop** before operating it, to prevent fire or smoke damage should the packing material ignite.
- **Be sure your cooktop is correctly adjusted by a qualified service technician or installer for the type of gas (natural or LP) which is to be used.** Your cooktop can be converted for use with either type of gas. See the installation instructions.
- **Do not attempt to repair or replace any part of your cooktop unless it is specifically recommended in this guide.** All other servicing should be referred to a qualified technician.

### WARNING—TO REDUCE THE RISK OF FIRE, ELECTRIC SHOCK, OR INJURY TO PERSONS, OBSERVE THE FOLLOWING:

- A. Use this unit only in the manner intended by the manufacturer. If you have questions, contact the manufacturer.

- B. Before servicing or cleaning the unit, switch power off at service panel.
- C. When cutting or drilling into wall or ceiling do not damage electrical wiring and other hidden utilities.
- D. Ducted fans must always be vented to the outdoors.
- E. To reduce the risk of fire, use only metal ductwork.

### WARNING—TO REDUCE THE RISK OF A COOKTOP GREASE FIRE:

- A. Keep fan, filters and grease laden surfaces clean.
- B. Always turn vent ON when cooking at high heat.
- C. Use high settings on cooktop only when necessary. Heat oil slowly on low to medium setting.
- D. Don't leave the cooktop unattended when cooking.
- E. Always use cookware and utensils appropriate for the type and amount of food being prepared.

### CAUTION—FOR GENERAL VENTILATING USE ONLY. DO NOT USE TO EXHAUST HAZARDOUS OR EXPLOSIVE MATERIALS AND VAPORS.

- **Do not leave children alone or unattended where a cooktop is hot or in operation.** They could be seriously burned.
- **CAUTION: Items of interest to children should not be stored in cabinets above a cooktop**—children climbing on the cooktop to reach items could be seriously injured.
- **When raising or lowering the vent**, keep fingers away from all vent parts; assure that cookware, pans and handles will not be struck and tipped when raising the vent.
- **Do not operate or clean your cooktop if the glass is broken or cracked.** Cleaning solutions and spillovers could penetrate the broken cooktop and create a risk of electric shock. Call for service immediately if the cooktop glass breaks or cracks.
- **Clean the cooktop with caution.** If a wet sponge or cloth is used to wipe spills on a hot cooktop be careful to avoid steam burns.
- **Do not clean the cooktop with flammable or volatile cleaning fluids.**
- **Do not clean the cooktop when the appliance is in use.**
- **Avoid scratching the cooktop** with sharp instruments, or with rings and other jewelry.
- **Let the burner grates and other surfaces cool before touching them or leaving them where children can reach them.**

- 
- **Never use the cooktop as a cutting board.**
  - **Never wear loose-fitting or hanging garments while using the appliance.** Be careful when reaching for items stored in cabinets over the cooktop. Flammable material could be ignited if brought in contact with flame or hot surfaces and may cause severe burns.
  - **For your safety, never use your appliance for warming or heating the room.**
  - **Do not use water on grease fires. Never pick up a flaming pan.** Turn the controls off. Smother a flaming pan on a surface burner by covering the pan completely with a well-fitting lid, cookie sheet or flat tray. Use a multi-purpose dry chemical or foam-type fire extinguisher.  
Flaming grease outside a pan can be put out by covering it with baking soda or, if available, by using a multi-purpose dry chemical or foam-type fire extinguisher.
  - **Do not store flammable materials near the cooktop.** Do not store or use gasoline or other flammable vapors and liquids in the vicinity of this or any other appliance.
  - **Do not let cooking grease or other flammable materials accumulate on or near the cooktop.**
  - **Never leave surface burners unattended at high flame settings.** Boilovers cause smoking and greasy spillovers that may catch on fire.
  - **Adjust surface burner flame size so it does not extend beyond the edge of the cookware.** Excessive flame is hazardous.
  - **Use only dry pot holders—**moist or damp pot holders on hot surfaces may result in burns from steam. Do not let pot holders come near open flames when lifting cookware. Do not use a towel or other bulky cloth in place of a pot holder.
  - **To minimize the possibility of burns,** ignition of flammable materials and spillage, turn cookware handles toward the side or center of the cooktop without extending over adjacent burner or vent area.
  - **Always turn the surface burners to off before removing the cookware.**
  - **Foods for frying should be as dry as possible.** Frost on frozen foods or moisture on fresh foods can cause hot fat to bubble up and over the sides of the pan.
  - **Use least possible amount of fat for effective shallow or deep fat frying.** Filling the pan too full of fat can cause spillovers when food is added.
  - **Carefully watch foods being fried at high flame setting.**
  - **If a combination of oils or fats will be used in frying,** stir together before heating, or as fats melt slowly.
  - **Always heat fat slowly,** and watch as it heats.
  - **Use a deep fat thermometer whenever possible** to prevent overheating fat beyond the smoking point.
  - **Use proper pan size—**avoid pans that are unstable or easily tipped. Select cookware having flat bottoms large enough to properly contain food and avoid boilovers and spillovers, and large enough to cover burner grate. This will both save cleaning time and prevent hazardous accumulations of food, since heavy spattering or spillovers left on cooktop can ignite. Use pans with handles that can be easily grasped and remain cool.
  - **Do not place hot cookware on the glass cooktop.** This could cause glass to break.
  - **Keep all plastics away from burners.**
  - **To avoid the possibility of a burn, always be certain that the controls for all burners are at the off position and all grates are cool before attempting to remove a grate.**
  - **If the cooktop is located near a window,** do not use long curtains which could blow over the burners and create a fire hazard.
  - **If you smell gas,** turn off the gas to the cooktop and call a qualified service technician. Never use an open flame to locate a leak.
  - **Do not cover or block the area around the cooktop knobs.** This area must be kept clear for proper ventilation and burner performance.
  - **When cooking pork,** follow the directions exactly and always cook the meat to an internal temperature of at least 170°F. This assures that, in the remote possibility that trichina may be present in the meat, it will be killed and the meat will be safe to eat.
  - **Do not use a wok on the cooking surface if the wok has a round metal ring which is placed over the burner grate to support the wok.** This ring acts as a heat trap which may damage the burner grate and burner head. Also, it may cause the burner to work improperly. This may cause a carbon monoxide level above that allowed by current standards, resulting in a health hazard.

**SAVE THESE INSTRUCTIONS**

# Features of Your Cooktop

## Downdraft Gas Cooktop

### Design information

(Not all features are on all models. Appearance may vary.)

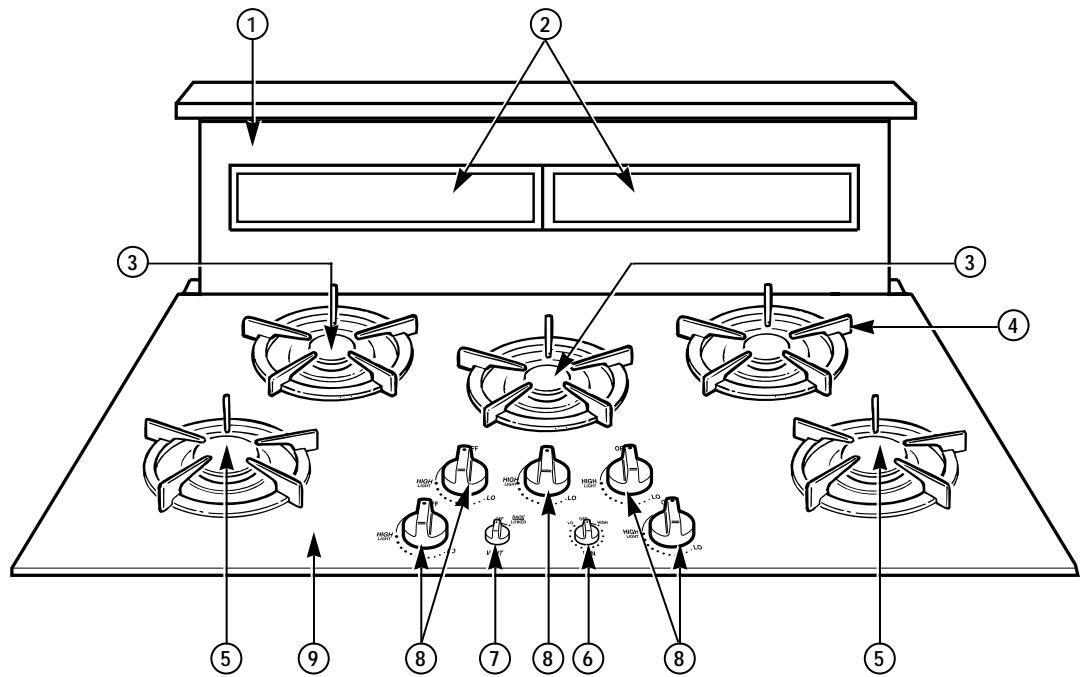

Feature Index	Page
1 Vent	9, 10
2 Vent Filters	10
3 Spillproof Burners	11
4 Cast-Iron Burner Grates	11
5 High Power Spillproof Burners	7
6 Fan Speed Control	9
7 Vent Control	9
8 Surface Unit Controls	7
9 Glass Cooktop Surface	10

# Using Your Cooktop

## Downdraft Gas Cooktop

### *Electric ignition*

Your surface burners are lighted by electric ignition, eliminating the need for standing pilot lights with constantly burning flames.

All the igniters make clicking sounds and spark even when only a single burner is being turned on. Do not touch any of the burners when the igniters are clicking.

The burners on this cooktop relight automatically if the flame goes out. This helps prevent the inconvenience of having to manually relight a burner.

As with electric ignition, all of the burner igniters spark while a burner is relighting.

**In case of a power outage**, you can light the surface burners on your cooktop with a match. Hold a lighted match to the burner, then turn the knob to the HIGH position. **Use extreme caution when lighting burners this way.**

Surface burners in use when an electrical power failure occurs will continue to operate normally.

### *To light a burner*

Push the control knob in and turn it **counterclockwise** to desired position from HIGH to LO.

**After the burner ignites**, turn the knob in either direction to adjust the flame size.

**To turn a burner off**, turn the knob clockwise, as far as it will go, to the OFF position.

- The center and two rear burners are best for smaller pans and cooking operations requiring carefully controlled simmering conditions. The two front burners are the high power burners for larger pans and fast boiling operations.
- Do not operate a burner for an extended period of time without cookware on the grate. The finish on the grate may chip without cookware to absorb the heat.
- Be sure the burners and grates are cool before you place your hand, a pot holder, cleaning cloths or other materials on them.

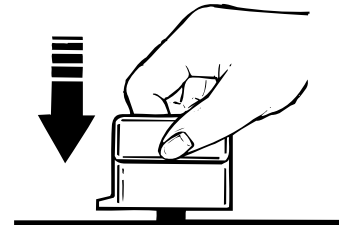

Check to be sure the burner you turned on is the one you want to use.

### *How to select flame size*

Watch the flame, not the knob, as you reduce heat.

The flame size on a gas burner should match the cookware you are using.

**FOR SAFE HANDLING OF COOKWARE, NEVER LET THE FLAME EXTEND UP THE SIDES OF THE COOKWARE.** Any flame larger than the bottom of the cookware is wasted heat and only serves to heat the handle.

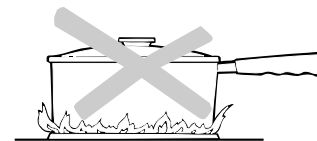

### Cookware

**Aluminum:** Medium-weight cookware is recommended because it heats quickly and evenly. Most foods brown evenly in an aluminum skillet. Use saucepans with tight-fitting lids for cooking with minimum amounts of water.

**Cast Iron:** If heated slowly, most skillets will give satisfactory results.

**Enamelware:** Under some conditions, the enamel of some cookware may melt. Follow cookware manufacturer's recommendations for cooking methods.

**Glass:** There are two types of glass cookware—those for oven use only and those for surface cooking (saucepans, coffee and teapots). Glass conducts heat very slowly.

**Heatproof Glass-Ceramic:** Can be used for either surface or oven cooking. It conducts heat very slowly and cools very slowly. Check cookware manufacturer's directions to be sure it can be used on gas cooktops.

**Stainless Steel:** This metal alone has poor heating properties, and is usually combined with copper, aluminum or other metals for improved heat distribution. Combination metal skillets generally work satisfactorily if they are used at medium heat as the manufacturer recommends.

### Wok cooking

We recommend that you use only a flat-bottomed wok. They are available at your local retail store.

**Do not use woks that have support rings.** Use of these types of woks, with or without the ring in place, can be dangerous. Placing the ring over the burner grate may cause the burner to work improperly resulting in carbon monoxide levels above allowable current standards. This could be dangerous to your health. Do not try to use such woks without the ring. You could be seriously burned if the wok tipped over.

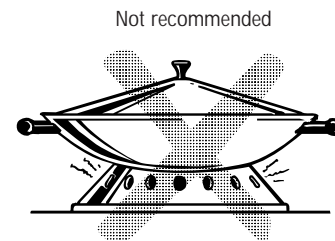
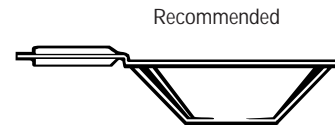

### Stove top grills

Do not use stove top grills on your sealed gas burners. If you use the stove top grill on the sealed gas burner it will cause incomplete combustion and can result in exposure to carbon monoxide levels above allowable current standards. This can be hazardous to your health.

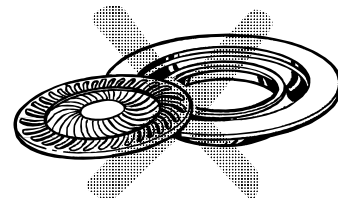



# Cooktop Vent System

*Downdraft Gas Cooktop*

## *General information*

**The built-in vent system helps remove cooking vapors, odors and smoke from foods prepared on the cooktop.**

Continuous use of the vent system helps keep the kitchen comfortable and less humid, reducing cooking odors and soiling moisture that normally creates a frequent need for cleaning.

## *Raising or lowering the vent*

**To raise the vent**, turn the VENT knob to the RAISE/LOWER position. The vent will rise to the fully extended position. There is no intermediate position.

**To lower the vent**, turn the VENT knob again to the RAISE/LOWER position. The vent will then descend.

**The vent fan will only operate in the fully extended position.**

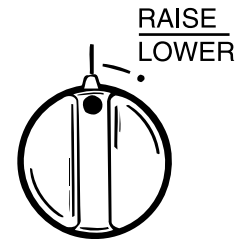

VENT

## *How to operate the vent system*

Turn the FAN knob to HIGH position to turn it on.

If you continue turning the FAN knob, you can select a fan speed between HIGH and LO.

The FAN knob does not have to be turned to OFF before the vent is lowered. The fan will automatically turn off when the VENT LOWER position is selected.

If the fan was not turned off when the vent was lowered, it will automatically come on at the previously selected speed when the vent is fully raised.

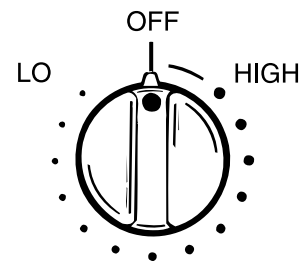

FAN

## *Caution!*

Be careful when raising or lowering the vent. Be sure pots, pot handles and other objects are clear of the vent cover and cannot be struck or tipped by the vent being raised. Keep hands and fingers away from all vent parts.

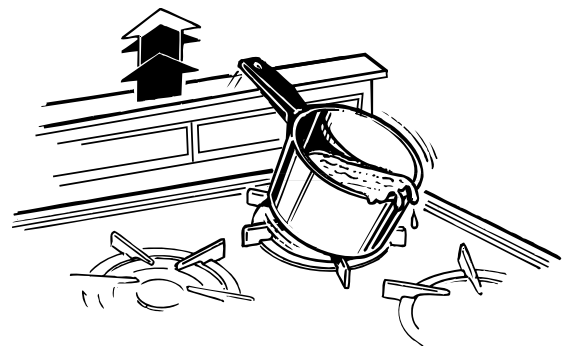

#### General information

Proper care and cleaning are important so your cooktop will give you efficient and satisfactory service. Follow these directions carefully in caring for it.

Before cleaning any part of your cooktop, be sure all burners are off and **DISCONNECT ELECTRICAL POWER TO THE COOKTOP** at the fuse box or circuit breaker panel, or pull the cooktop power plug, located beneath the cooktop and inside the cabinets.

#### Glass cooktop

To keep the cooktop looking its best, wipe up any spills as they occur. This will keep them from burning on and becoming more difficult to remove.

As soon as the cooktop is cool, wash the glass surface with a cloth moistened with warm, soapy water; rinse with clean water, and dry with a soft cloth. You can use any liquid household detergent.

Do not use abrasive materials such as metal pads, cleansing powder and scouring pads—they may scratch the surface. Do not use harsh chemicals such as bleach or chemical oven cleaners.

#### **CAUTION: DO NOT COOK ON OR CLEAN A BROKEN OR CRACKED COOKTOP.**

Cleaning solutions and spillovers penetrating the cooktop can create a risk of electric shock. Call for a service technician immediately.

#### Grease filters

The efficiency of your downdraft depends on a clean filter. Frequency of cleaning depends on the type of cooking you do. Grease filters should be cleaned at least once a month. Never operate the downdraft without the filters in place.

**To remove:** Lift up and pull the bottom out. Remove the left filter first, then slide the right filter to the left and remove it.

**To clean:** Soak and then agitate in a hot detergent solution. Light brushing may be used to remove imbedded soil. Rinse, shake and remove moisture before replacing. Filters may be cleaned by placing in dishwasher, although some slight color fading may occur after several washings.

With careful handling, the filter will last for years. If replacement becomes necessary, order the part from your dealer.

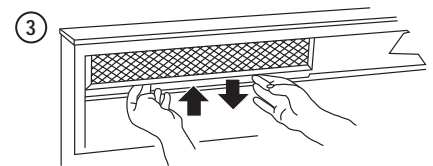
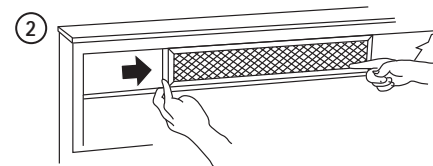
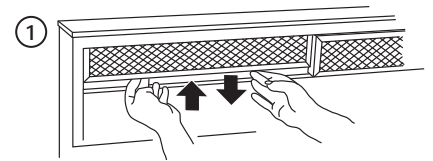

#### Control knobs

The control knobs may be removed for cleaning.

**To remove knob,** pull it straight up.

Wash knobs in soap and water but do not soak. Avoid getting water down into the knob stem holes.

## Burner assembly

The burner assemblies should be wiped clean often.

Turn all controls OFF before removing burner parts.

**The electrode of the spark igniter is exposed when the top of the burner is removed. Be careful not to push in any surface unit controls while the top of a burner is removed. A slight electrical shock might result which could cause you to knock over hot cookware.**

**CAUTION: DO NOT OPERATE THE BURNER WITHOUT ALL BURNER PARTS IN PLACE.**

The burner grates and caps can be lifted off, making them easy to clean. Removing them gives you access to the burner base and burner bowl. Wash the grate and cap in hot, soapy water and rinse with clean water. Dry them with a cloth—don't reassemble them wet. When replacing these parts, be sure they fit securely into position over the burners.

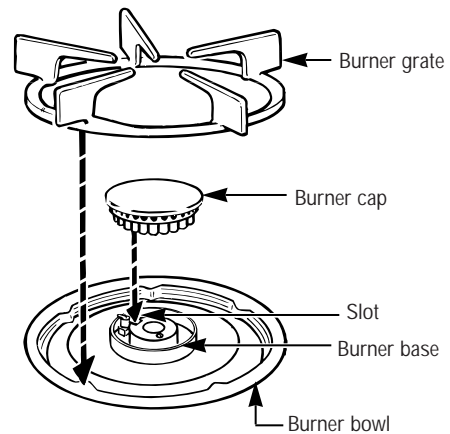

## Burner grates

Cast-iron burner grates should be washed regularly and, of course, after spills.

Wash them in hot, soapy water and rinse with clean water. Dry the grates with a cloth—don't put them back on the cooktop wet. When replacing the grates, be sure they're positioned securely over the burners.

**To get rid of burned-on food**, place the grates in a covered container or plastic bag. Add 1/4 cup ammonia and let them soak for 30 minutes. Wash, rinse well, and dry.



**To prevent rusting**, apply a light coating of cooking oil on the bottom of the grates.

**Although they're durable, the grates will gradually lose their shine**, regardless of the best care you can give them. This is due to their continual exposure to high temperatures.

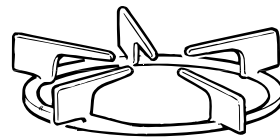
**Do not operate a burner for an extended period of time without cookware on the grate.** The finish on the grate may chip without cookware to absorb the heat.



*Questions?  
Before you  
call for  
service...*

PROBLEM	POSSIBLE CAUSE
<b>BURNERS DO NOT LIGHT</b>	<ul style="list-style-type: none"> <li>· Make sure electrical plug is plugged into a live power outlet.</li> <li>· Slot in burner base may be clogged. Remove the obstruction.</li> <li>· Burner parts not replaced correctly.</li> <li>· Hole in burner cap behind igniter may be clogged.</li> </ul>
<b>BURNERS HAVE YELLOW OR YELLOW-TIPPED FLAMES</b>	<div style="display: flex; justify-content: space-around; align-items: flex-start;"> <div style="text-align: center;">  <p><b>A. Yellow flames:</b> <i>Call for service.</i></p> </div> <div style="text-align: center;">  <p><b>B. Yellow tips on outer cones:</b> <i>Normal for LP gas.</i></p> </div> <div style="text-align: center;">  <p><b>C. Soft blue flames:</b> <i>Normal for natural gas.</i></p> </div> </div> <ul style="list-style-type: none"> <li>· If burner flames look like <b>(A)</b>, call for service. Normal burner flames should look like <b>(B)</b> or <b>(C)</b>, depending on the type of gas.</li> </ul>
<b>BURNER FLAMES VERY LARGE OR YELLOW</b>	<ul style="list-style-type: none"> <li>· If cooktop is connected to LP gas, check all steps in the installation instructions.</li> </ul>
<b>BURNER CONTROL KNOB WILL NOT TURN</b>	<ul style="list-style-type: none"> <li>· When the knob is at the OFF position, it must be pushed in before it can be turned, and it can only be turned in a <b>counterclockwise</b> direction. When the knob is at any other position, it can be turned in either direction without being pushed in.</li> </ul>
<b>FAN DOES NOT WORK</b>	<ul style="list-style-type: none"> <li>· The vent must be fully extended before fan will work.</li> <li>· Fan control knob must be turned in <b>clockwise</b> direction to turn fan on.</li> </ul>

**If you need more help...call, toll free:**  
**GE Answer Center®**  
**800.626.2000**  
**consumer information service**

*With the purchase of your new Monogram appliance, receive the assurance that if you ever need information or assistance from GE, we'll be there. All you have to do is call—toll-free!*

---

## **GE Answer Center®**

**800.626.2000**

Whatever your question about any Monogram major appliance, GE Answer Center® information service is available to help. Your call—and your question—will be answered promptly and courteously. And you can call any time. GE Answer Center® service is open 24 hours a day, 7 days a week.

---

## **In-Home Repair Service**

**800-444-1845**

A GE consumer service professional will provide expert repair service, scheduled at a time that's convenient for you. Many GE Consumer Service company-operated locations offer you service today or tomorrow, or at your convenience (7:00 a.m. to 7:00 p.m. weekdays, 9:00 a.m. to 2:00 p.m. Saturdays). Our factory-trained technicians know your appliance inside and out—so most repairs can be handled in just one visit.

---

## **For Customers With Special Needs...**

**800.626.2000**

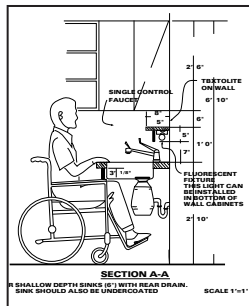

GE offers, free of charge, a brochure to assist in planning a barrier-free kitchen for persons with limited mobility.

Consumers with impaired hearing or speech who have access to a TDD or a conventional teletypewriter may call 800-TDD-GEAC (800-833-4322) to request information or service.

---

## **Service Contracts**

**800-626-2224**

You can have the secure feeling that GE Consumer Service will still be there after your warranty expires. Purchase a GE contract while your warranty is still in effect and you'll receive a substantial discount. With a multiple-year contract, you're assured of future service at today's prices.

---

## **Parts and Accessories**

**800-626-2002**

Individuals qualified to service their own appliances can have parts or accessories sent directly to their home. The GE parts system provides access to over 47,000 parts...and all GE Genuine Renewal Parts are fully warranted. VISA, MasterCard and Discover cards are accepted.

**User maintenance instructions contained in this guide cover procedures intended to be performed by any user. Other servicing generally should be referred to qualified service personnel. Caution must be exercised, since improper servicing may cause unsafe operation.**

## ***YOUR MONOGRAM COOKTOP WARRANTY***

***Staple sales slip or cancelled check here. Proof of original purchase date is needed to obtain service under warranty.***

---

### ***WHAT IS COVERED***

#### **FULL ONE-YEAR WARRANTY**

For one year from date of original purchase, we will provide, free of charge, parts and service labor in your home to repair or replace **any part of the cooktop** that fails because of a manufacturing defect.

.....

This warranty is extended to the original purchaser and any succeeding owner for products purchased for ordinary home use in the 48 mainland states, Hawaii and Washington, D.C. In Alaska the warranty is the same except that it is LIMITED because you must pay to ship the product to the service shop or for the service technician's travel costs to your home.

All warranty service will be provided by our Factory Service Centers or by our authorized Customer Care® servicers during normal working hours.

Should your appliance need service, during warranty period or beyond, call 800-444-1845.

---

### ***WHAT IS NOT COVERED***

· Service trips to your home to teach you how to use the product.

#### **Read your Use and Care material.**

If you then have any questions about operating the product, please contact your dealer or our Consumer Affairs office at the address below, or call, toll free:

**GE Answer Center®**

**800.626.2000**

**consumer information service**

· Replacement of house fuses or resetting of circuit breakers.

· Damage to the product caused by accident, fire, floods or acts of God.

· Failure of the product if it is used for other than its intended purpose or used commercially.

· Improper installation.

If you have an installation problem, contact your dealer or installer. You are responsible for providing adequate electrical, gas, exhausting and other connecting facilities as described in the Installation Instructions provided with the product.

**WARRANTOR IS NOT RESPONSIBLE FOR CONSEQUENTIAL DAMAGES.**

---

Some states do not allow the exclusion or limitation of incidental or consequential damages, so the above limitation or exclusion may not apply to you. This warranty gives you specific legal rights, and you may also have other rights which vary from state to state.

To know what your legal rights are in your state, consult your local or state consumer affairs office or your state's Attorney General.

**Warrantor: General Electric Company. If further help is needed concerning this warranty, write: Manager—Consumer Affairs, GE Appliances, Louisville, KY 40225**

# Consumer Product Ownership Registration Important Mail Today

*GE Appliances*



Place  
1st Class  
Letter  
Stamp  
Here

*General Electric Company*  
Warranty Registration Department  
P.O. Box 34070  
Louisville, KY 40232-4070

# Consumer Product Ownership Registration

Dear Customer:

Thank you for purchasing our product and thank you for placing your confidence in us. We are proud to have you as a customer!

Follow these three steps to protect your new appliance investment:

**1** Complete and mail your Consumer Product Ownership Registration today. Have the peace of mind of knowing we can contact you in the unlikely event of a safety modification.

**2** After completing this registration, write your model and serial numbers in this guide. You will need this information should you require service. Our service number is 800-444-1845.

**3** Read your "Use and Care Guide" carefully. It will help you operate your new appliance properly. If you have questions, or need more information call the GE Answer Center® 800.626.2000.

**Important:** To ensure that your product is registered, fold and mail this form. No envelope is needed.

## Consumer Product Ownership Registration



Product  
Downdraft Gas Cooktop

Model

Serial

Mr. 1 Ms. 1 Mrs. 1 Miss 1

First Name											Last Name										
Street Address																					
Apt. #																					
City											State		Zip Code								
Date Placed In Use	Month	Day		Year		Phone Number															



*GE Appliances*

General Electric Company  
Louisville, Kentucky 40225

CUT HERE



Part No. 183D5580P041

Pub No. 49-8838

4-97 CG

Printed in Mexico



## Free Manuals Download Website

<http://myh66.com>

<http://usermanuals.us>

<http://www.somanuals.com>

<http://www.4manuals.cc>

<http://www.manual-lib.com>

<http://www.404manual.com>

<http://www.luxmanual.com>

<http://aubethermostatmanual.com>

Golf course search by state

<http://golfingnear.com>

Email search by domain

<http://emailbydomain.com>

Auto manuals search

<http://auto.somanuals.com>

TV manuals search

<http://tv.somanuals.com>