

Monogram.

Use and Care Guide

for ZBD3000

Dishwasher

*1993 Monogram.<sup>TM</sup>*

*Dishwasher*

---

## Introduction

Your new Monogram dishwasher makes an eloquent statement of style, convenience and kitchen planning flexibility. Whether you chose it for its purity of design or the assiduous attention to detail, you' ll find that your Monogram dishwasher's superior blend of form and function will delight you for years to come.

The ZBD3000 Monogram dishwashers were designed to provide the flexibility to blend in with your kitchen cabinetry. Its sleek design can be beautifully integrated in the kitchen.

The information on the following pages will help you operate and maintain your dishwasher properly.

If you have any other questions—please call the GE Answer Center® (800.626.2000).

---

## Contents

Air Gap .....	19	Model and Serial Numbers .....	3
Appliance Registration .....	3	Operating Instructions, Tips ....	6-14
Care and Cleaning .....	19	POTSCRUBBER.....	6, 12, 14
China, Crystal, Sterling .....	18	Problem Solver .....	2 1-23
Consumer Services .....	26	Repair Service .....	3
Convenience Features .....	3	Rinse Agent .....	13, 22
Cycle Features .....	6	Safety Instructions .....	4
Detergent Guide .....	14	Soil Level .....	7, 12
Dispenser Cups .....	14	Systems Monitor .....	9 - 11
Dishwasher Shortcuts .....	8	User Maintenance .....	19
Drying Options .....	7	Warranty .....	27
Energy-Saving Tips .....	5	Water Temperature .....	13
Features . . .	6, 7	Winter Storage .....	19
Front panel Change .....	20	<b>Questions?</b>	
Important Phone Numbers .....	26	<b>Call GE Answer Center®</b>	
Loading .....	15-17	<b>800.626.2000</b>	
Lock Controls Feature .....	8		

---

### **Before using your dishwasher, read this book carefully.**

It is intended to help you operate and maintain your new dishwasher properly.

Keep it handy for answers to your questions.

If you don't understand something or need more help, write (include your phone number):

Consumer Affairs  
GE Appliances  
Appliance Park  
Louisville, KY 40225

---

## Write down the model and serial numbers.

You'll find them on a label fastened to the tub wall just inside the dishwasher door.

These numbers are also on the Consumer Product Ownership Registration Card that came with your dishwasher. Before sending in this card, please write these numbers here:

\_\_\_\_\_

Model Number

\_\_\_\_\_

Serial Number

Use these numbers in any correspondence or service calls concerning your dishwasher.

---

## If you received a damaged dishwasher...

Immediately contact the dealer (or builder) that sold you the dishwasher.

## Save time and money. Before you request service...

Check the Problem Solver in the back of this guide. It lists causes of minor operating problems that you can correct yourself.

---

## If you need service...

To obtain service, see the Consumer Services page in the back of this guide.

We're proud of our service and want you to be pleased. If for some reason you are not happy with the service you receive, here are 3 steps to follow for further help.

FIRST, contact the people who serviced your appliance. Explain why you are not pleased. In most cases, this will solve the problem.

NEXT, if you are still not pleased, write all the details—including your phone number—to:

Manager, Consumer Relations  
GE Appliances  
Appliance Park  
Louisville, KY 40225

FINALLY, if your problem is still not resolved, write:

Major Appliance Consumer  
Action Panel  
20 North Wacker Drive  
Chicago, IL 60606

---

## Convenience Features

- Lets you select fast, heated drying or energy-saving, no-heat drying.
- A SYSTEMS MONITOR that tells you what's happening in the dishwasher and if certain things are wrong.
- Lets you LOCK the controls to prevent accidental tampering.
- Remembers your last cycle so you don't have to reprogram each time. See SHORTCUT on page 8.

This dishwasher has many convenient features. Among them are:

- Controls are arranged left to right as you use them.
- Automatic "beep" responses to your instructions and a lighted display let you know the desired function has been selected.
- Lets you adjust your washing cycle to the amount of soil on your dishes.

# IMPORTANT SAFETY INSTRUCTIONS

Read all instructions before using this appliance.

# A

**WARNING**—When using this appliance, always exercise basic safety precautions, including the following:

• Use **this appliance only for its intended purpose, as you will find described in this Use and Care Guide.**



\*This dishwasher must be properly installed and located in accordance with the Installation Instructions before it is used. If you did not receive an Installation Instructions sheet with your dishwasher, you can obtain one by calling, toll free, the GE Answer Center®, 800.626.2000.

—This appliance must be connected to a grounded metal, permanent wiring system; or an equipment-grounding conductor must be run with the circuit conductors and connected to the equipment-grounding terminal or lead of the appliance.

—Connect to a properly rated, protected and sized power-supply circuit to avoid electrical overload.



• **Do not store or use combustible materials, gasoline or other flammable vapors and liquids in the vicinity of this or any other appliance.**

• Use only powder or liquid detergents or wetting agents recommended for use in a dishwasher.

\* Do not wash plastic items unless marked “dishwasher safe” or the equivalent. For plastic items not so marked, check the manufacturer’s recommendations.

• Load light plastic items so they will not become dislodged and drop to the bottom of the dishwasher—they might come into contact with the Calrod® heating element and be damaged.

## To minimize the possibility of injury.

- When loading items to be washed:
- Locate sharp items so that they are not likely to damage the door seal, and
  - Load sharp knives with the handles up to reduce the risk of cut-type injuries.

- Do not tamper with controls.
- Do not touch the Calrod® heating element during or immediately after use.
- Do not operate your dishwasher unless all enclosure panels are properly in place.
- Do not abuse, sit on, or stand on the door or dish rack of the dishwasher,
- Close supervision is necessary if this appliance is used by or near children. Do not allow children to play inside, on or with this appliance or any discarded appliance. Dispose of discarded appliances and shipping or packing material properly. Before discarding a dishwasher, remove the door of the washing compartment.
- Keep all washing detergents and wetting agents out of the reach of children, preferably in a locked cabinet. Observe all warnings on container labels to avoid personal injury.



- To minimize the possibility of electric shock, disconnect this appliance from the power supply before attempting any maintenance. **NOTE:** Turning the control dial to the OFF position does not disconnect the appliance from the power supply. We recommend having a qualified technician service your appliance.

# A

**WARNING—HYDROGEN GAS** is produced by the chemical action within your water heater. It can accumulate in the water heater and/or water pipes if hot water has not been used for a period of two weeks or longer. **HYDROGEN GAS IS EXPLOSIVE.** To prevent the possibility of damage or injury, if you have not used hot water for two weeks or more, or moved into a residence in which the hot water system may not have been used for some time, turn on all hot water faucets and allow them to run for several minutes before using any electrical appliance which is connected to the hot water system. This will allow any hydrogen gas to escape. Also, since the gas is flammable, do not smoke or use an open flame or appliance during this process.

## SAVE THESE INSTRUCTIONS

---

## ENERGY-SAVING TIPS

- **Operate the dishwasher only when it's full.** Let the dishes accumulate in dishwasher. When you put in only a partial load, use the RINSE & HOLD cycle to rinse off heavy soils. Be sure to latch the door when waiting for a full load. This helps to keep soils moist, easier to remove.

**Always select the cycle that uses the least amount of water that will remove the soil from the load.**

- Turn your water heater down to deliver 120°F. water to your dishwasher and use the WASH HEAT BOOST Option. Make sure the entering water temperature is no less than 120°F. (See How to Test Water Temperature section).
- Select a SOIL OPTION that will remove soil from load.
- If you don't need your dishes right away, use your **HEATED DRY off (Energy saver) feature** that turns the drying heater off automatically. Dishes dry naturally over a longer period such as overnight.
- Watch the SYSTEMS MONITOR for more ideas. See Systems Monitor section.

# HOW TO OPERATE YOUR DISHWASHER

**Step 1.** Load your dishwasher with dishes, silverware, pots, pans, bowls, etc. according to instructions in the Loading section.

**Step 2.** Add detergent to the detergent dispenser.

Use rinse aid agent to help prevent spotting. (See How to Use a Rinse Agent section.)

Close and latch dishwasher door.

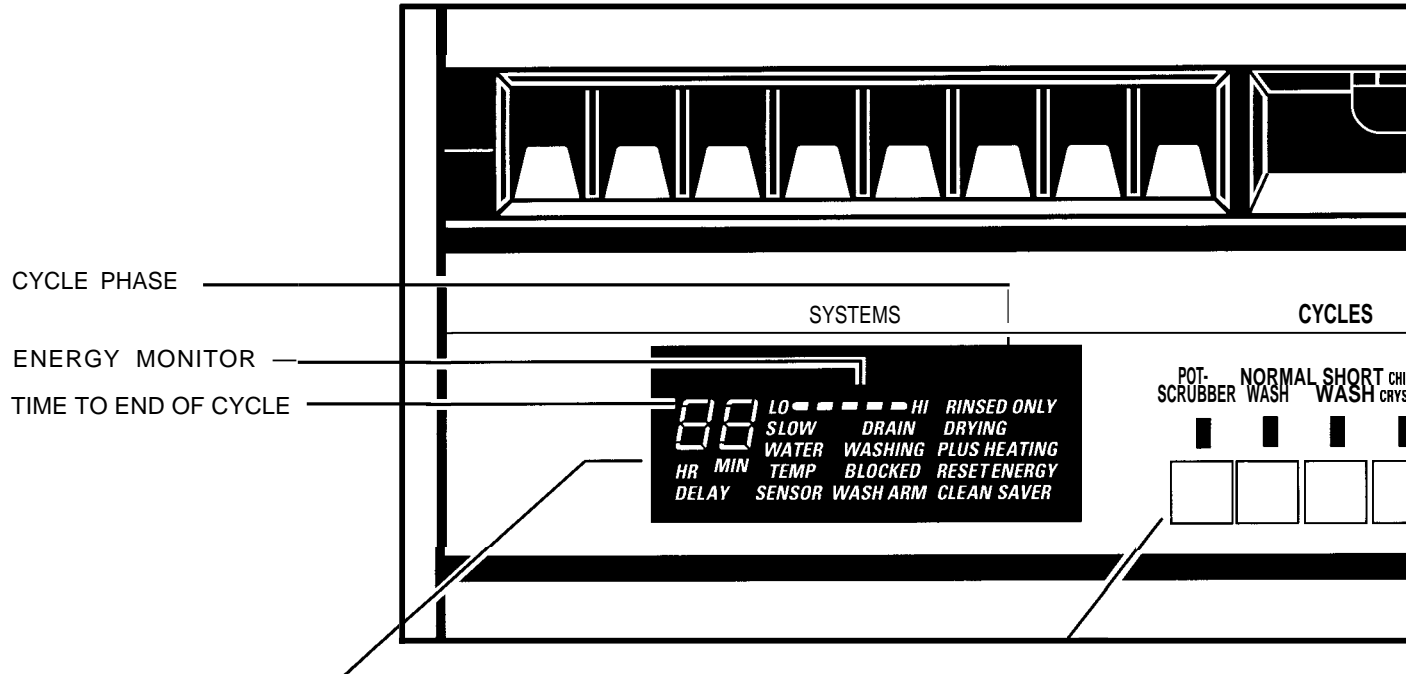

## Systems Monitor

This panel tells you what is happening in the dishwasher and can alert you to some possible problems.

### Information displayed:

- Selected wash cycle
- Selected dry option
- Minutes to end of cycle
- Cycle phase, such as WASHING, RINSING or DRYING
- Diagnostic codes to alert you to possible problems
- Relative energy used by each cycle. Lets you choose the cycle you need that uses the least energy.

See Systems Monitor section for explanation of displays and codes.

## Step 3. Select desired wash cycle.

Touch the center of the pad.

- **POTSCRUBBER** is for items such as pots, pans and casseroles. Everyday dishes may be included.
- **NORMAL WASH** is for loads of everyday dishes with medium soils. Designed to yield high performance on normal loads.
- **SHORT WASH** is for most loads of everyday dishes with light soils or soils that have not dried on. It saves hot water over the higher performance cycles, thus saving energy. *Pre-rinse dishware before loading.*
- **CHINA CRYSTAL** is for lightly soiled china and crystal. The wash action is softened by pumping air along with the water to protect your delicate items. *Pre-rinse dishware before loading.* Follow loading instructions in the Loading section.

- **RINSE & HOLD** is for rinsing partial loads which will be washed later. *Do not use detergent.* Do not use DELAY START with this cycle.

**To change a setting,** just touch desired pad.

Your dishwasher is now automatically programmed including a Soil Option Selection. Cycle Indicator Lights tell you the complete program and a number in the SYSTEMS MONITOR will tell you how long the cycle will take. If you're satisfied, just touch the START pad.

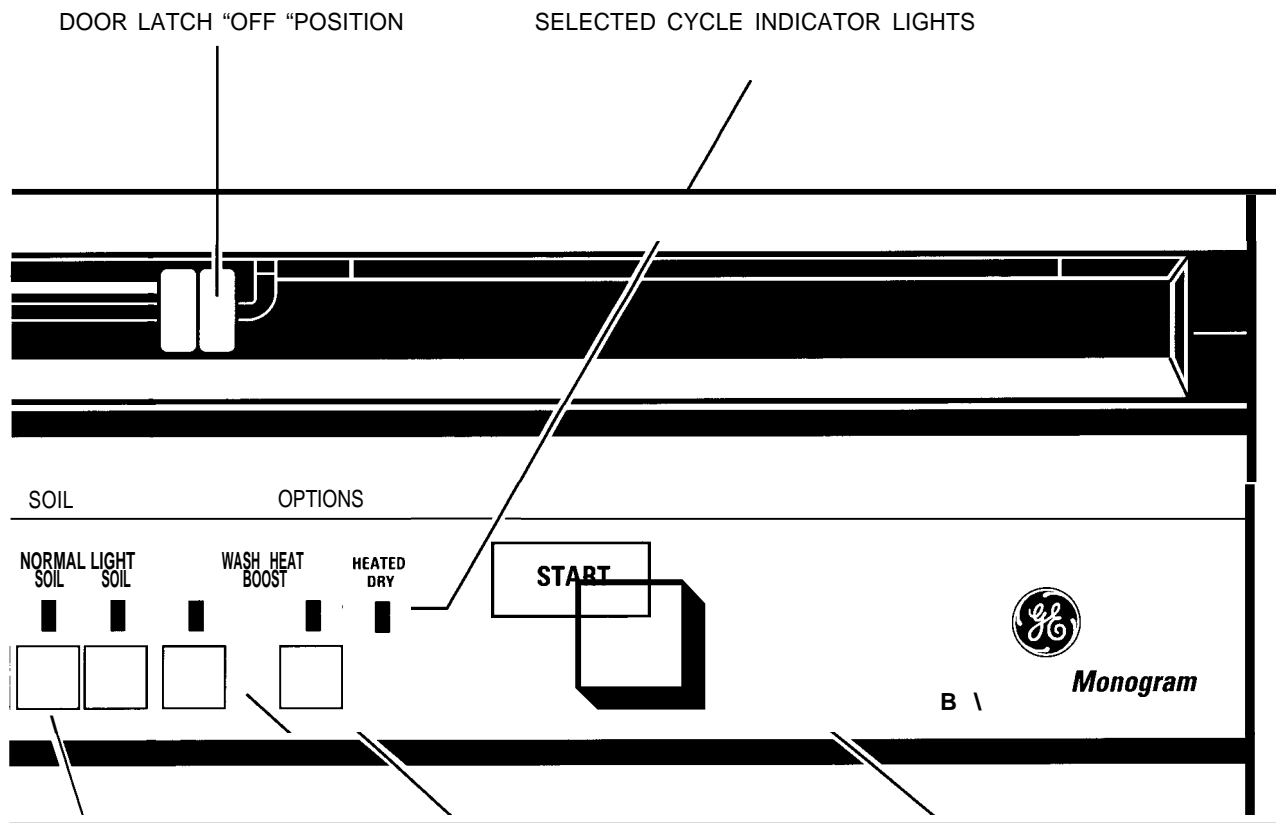

#### Step 4. Select a soil option

If you wish to make program changes, start with the soil level. You should select a change within 30 seconds, otherwise all panel lights will go out. To relight, touch any pad or open and reclose door.

- **HEAVY SOIL** should be selected when dishes are extra soiled or extra greasy. This gives dishes an extra rinse in every cycle except RINSE & HOLD. This lengthens cycle.
- **NORMAL SOIL** is automatically programmed when a cycle is selected. You may want to change the selection depending on the soil on your dishes.
- **LIGHT SOIL** will save time and money if you pre-rinse your dishes. This shortens all cycles except RINSE & HOLD.

#### Step 5. Select a drying option

- **HEATED DRY** on—Provides faster drying. Can be changed while cycle is running.
- **HEATED DRY** off (Energy Saver)—Shuts off heating unit. Dishes air-dry naturally. It takes longer, but saves energy. You can prop door open about 3 inches after motor stops to speed drying. Excellent for overnight drying.  
Energy Saver helps reduce energy used by this model approximately 6%.
- **WASH HEAT BOOST.** See How to Test Water Temperature section. The entering water must be between 120°F. and 140°F. Use wash heat boost option when water is less than 140°F.  
When selected, the wash cycle will be extended for 21 minutes while the dishwasher heats the water for good washing and drying.

#### Step 6. Start dishwasher

- When you're ready to wash dishes, touch the START pad. There is a time delay between start-up and water fill so you will not hear any wash action right away. Dishwasher will proceed through your entire program and turn off automatically.
- To delay the start,** touch DELAY START pad. The SYSTEMS MONITOR will read "1 hrs delay." Touch pad once again for each hour desired up to 14 hours. The machine will count down and start automatically at the correct time.
- NOTE:** Don't forget to put detergent in cup and close cup. Do not use DELAY START with the RINSE & HOLD cycle.
- To change a cycle after washing starts,** touch the CLEAR RESET pad to cancel cycle. After water is pumped out and motor stops, you can reprogram and restart the dishwasher.

# OPERATING INSTRUCTIONS

(continued)

## Dishwashing Shortcut



The dishwasher remembers your last cycle so you don't have to reprogram each time.

When the dishwasher is loaded and the door latch is moved to the ON position, the control panel will display the last settings you selected.

If you don't want to change any of the settings, simply touch START.

NOTE: If there has been a power failure, NORMAL WASH, NORMAL SOIL and HEATED DRY off will automatically be programmed. Make any new selections as desired and touch START.

## How to lock dishwasher controls to prevent use by children

Your dishwasher has a "hidden" control pad. When this pad is touched twice within 3 seconds, all pads become inoperative and no new selections can be made until the lock is released. The word LOCKED appears in the SYSTEMS MONITOR.



Children cannot accidentally start dishwasher by touching pads. The only control unaffected is the DELAY START. If this selection has been made, dishwasher will start automatically after whatever delay you have selected.

Touch here twice within 3 seconds to lock or unlock the control panel.

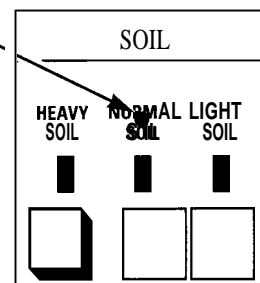



# THE SYSTEMS MONITOR TELLS YOU WHAT'S HAPPENING

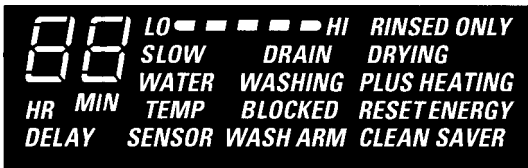

DISPLAY	WHAT IT MEANS
NUMERALS FROM 1 to 99 MINUTES	Number of minutes left in the cycle.
NUMERALS FROM 1 to 14 HRS. DELAY	Number of hours delay until start of cycle.
ENERGY MONITOR LO—_—_—_— HI	Shows relative amount of energy used from LO (one bar lighted) to HI (all five bars lighted).
ENERGY SAVER	Indicates energy-efficient selection made such as SHORT WASH, LIGHT SOIL or ENERGY SAVER (UNHEATED) DRYING.
WASHING	Displayed during Pre-wash, Pre-rinse and Main Wash periods.
RINSE	Displayed during Rinse periods following the Main Wash.
DRYING	Displayed during HEATED DRY on when selected.
RINSED ONLY	Indicates completion of RINSE & HOLD cycle. Remains on until door is unlatched.
HEATING	Indicates water is being heated—in wash or rinse period—to temperature necessary for good washability. The minutes countdown is on hold for up to a maximum of 30 minutes when “HEATING” is displayed.
CLEAN	Indicates completed cycle (except RINSE & HOLD). Remains on until door is unlatched.
LOCKED	Indicates controls are locked to prevent unauthorized use.
PF RESET	Indicates a power failure occurred.
RESET	The CLEAR RESET pad was touched.

# THE SYSTEMS MONITOR TELLS YOU IF CERTAIN THINGS ARE WRONG

DISPLAY	WHAT IT MEANS	WHAT TO DO
<b>PF</b> and RESET	Electrical power to the dishwasher has been interrupted but is now back on.	<b>IF DISHWASHER WAS IN USE WHEN THE POWER FAILURE OCCURRED:</b> <ol style="list-style-type: none"> <li>1. Unlatch the door. If the detergent cup is open, add detergent and close the cup.</li> <li>2. Relatch the door and touch "START," then immediately touch "CLEAR RESET." (This will pump any remaining water out of the machine.)</li> <li>3. Select the desired cycle and rerun the load.</li> </ol> <b>IF THE DISHWASHER WAS <i>NOT</i> IN USE:</b> <ol style="list-style-type: none"> <li>1. Latch door.</li> <li>2. Select desired cycle.</li> <li>3. Run cycle when desired.</li> </ol>
<b>BLOCKED WASH ARM</b>	An obstruction is preventing the lower wash arm from turning. This is usually caused by a utensil sticking through the bottom of the lower rack.	<ol style="list-style-type: none"> <li>1. Unlatch door.</li> <li>2. Check the lower rack for any item that could block the wash arm and reposition it.</li> <li>3. Relatch door.</li> </ol> <b>NOTE:</b> If the wash arm is not blocked and "WASH ARM BLOCKED" display still appears, you may start wash cycle by pressing START pad a second time.
<b>SLOW DRAIN</b>	The dishwasher is taking longer than normal to drain the water out. This is usually caused by a blockage in the drain air gap (see Air Gap section), a kink in the drain hose, or a stopped-up drain pipe.	This dishwasher is designed to automatically compensate for longer than normal drain times, but cycle time will be extended. If this code continues to appear frequently: <ol style="list-style-type: none"> <li>1. Clean the air gap (See Air Gap section).</li> <li>2. Check for a kink in the drain hose.</li> <li>3. Check plumbing for slow or stopped-up drains. (NOTE: Warranty service does not cover household drain problems.)</li> </ol>
<b>BLOCKED DRAIN</b>	Similar to slow drain. This indicates that the drain is so clogged that the dishwasher cannot continue to operate in a satisfactory manner. Dishwasher will stop.	Locate and remove the blockage in the drain system. To pump any remaining water out of the machine: <ol style="list-style-type: none"> <li>1. Latch door.</li> <li>2. Select any cycle.</li> <li>3. Touch "START" and then immediately touch "CLEAR RESET." (NOTE: Warranty service does not cover household drain problems.)</li> </ol>
<b>DRAIN SENSOR</b>	Dishwasher will continue cycle along with a drain period.	If DRAIN SENSOR repeats for the next cycle, call for service.
<b>TEMP SENSOR</b>	The temperature sensor in the dishwasher is not functioning properly. Dishwasher may continue to be used, but it will not heat water automatically.	The temperature sensor needs to be replaced. Call for service.  <b>NOTE:</b> You may continue to use your dishwasher. For best results adjust your household water heater thermostat to 140°F.

DISPLAY	WHAT IT MEANS	WHAT TO DO
DRAIN WATER	There is too much water in the dishwasher. If DRAIN WATER appears after a power failure, this is normal and the dishwasher will correct itself.	<p>The dishwasher is designed to automatically pump out extra water as long as the door is latched. When you hear the motor stop running:</p> <ol style="list-style-type: none"> <li>1. Unlatch the door and see if all the water is gone. (It is normal for a small amount of water to remain in the bottom of tub to keep the water seal lubricated.)</li> <li>2. If you see water entering the dishwasher, close and latch the door. Shut off the water supply to the dishwasher.</li> <li>3. If water is gone and no water is entering the dishwasher, restart cycle.</li> <li>4. If DRAIN WATER repeats, shut off the water supply to the dishwasher. Call for service.</li> </ol>
LOW WATER	<p>This can be caused by either of these reasons:</p> <p>Not enough water is entering the dishwasher.</p> <p style="text-align: center;">or</p>	<p>Unlatch the door. If there is no water in the bottom of the dishwasher, check the water supply to the dishwasher.</p> <ul style="list-style-type: none"> <li>•Is the dishwasher water supply turned on? (Valve usually located under the sink.)</li> <li>•Is the household water supply turned on?</li> <li>•If you use well or cistern water, is the supply adequate?</li> </ul> <p>If the water supply is adequate, try the cycle again. If LOW WATER repeats, call for service.</p>
	The drain pump could be temporarily blocked (usually caused by food particles such as cereal).	<p>Unlatch the door. If there is standing water in the bottom of the dishwasher, relatch the door, touch "START," then immediately touch "CLEAR RESET" to start the pump. If LOW WATER continues to appear, you may need to do this several times to breakup the blockage.</p>
LOW WATER TEMP	The water temperature in the dishwasher did not reach the proper wash temperature. This is usually caused by lack of hot water coming from the household water heater.	<p>Avoid showers or laundry just prior to running the dishwasher. (Use the "DELAY START" feature to start dishwasher when the water heater is up to normal temperature.) Adjust household water heater thermostat to 120°F. minimum</p> <p>If LOW WATER TEMP appears nearly every cycle and you know the water from the household water heater is hot (120°F. or more), call for service.</p>

### Before you call for service

- Try the cycle again to see if the Code reappears. The dishwasher may correct itself.
- Electronic controls can be affected by outside interference.
- Sometimes shutting off the power to the dishwasher (at the fuse or circuit breaker) will correct the problem.
- Restore power after about five seconds and try the cycle again.
- Check the guide for things you can do to correct the problem.

# OPERATING INSTRUCTIONS

(continued)

## What happens in each cycle

- You'll hear occasional clicking sounds:
  - Soft food disposer shredding action.
  - Drain valve opening to pump water out.
  - Detergent cup opening.
- The motor stops during drying.
- Water vapor comes through the vent by the door latch during drying and when water is being pumped out.

Number Fills	Wash Cycles	Water Usage Gallons (Approx.)			Cycle Sequence	Cycle Time Minutes (Approx.)								
		Heavy Soil	Med Soil	Light Soil		Heavy Soil	Med. Soil	Light Soil						
7	POTSCRUBBER	11	11		PreWash/PreRinse	PreRinse	PreRinse	Main Wash	Rinse	Rinse	Rinse	63*	61*	
6	POTSCRUBBER			9		PreWash/PreRinse	PreRinse	Main Wash	Rinse	Rinse	Rinse			57*
7	POTSCRUBBER	10			PreWash/PreRinse	PreRinse	PreRinse	Main Wash	Rinse	Rinse	Rinse	55		
6	NORMAL WASH		9	9		PreWash/PreRinse	PreRinse	Main Wash	Rinse	Rinse	Rinse		51*	49*
7	SHORT WASH	10			PreRinse	PreRinse	PreRinse	Main Wash	Rinse	Rinse	Rinse	35		
6	SHORT WASH		9			PreRinse	PreRinse	Main Wash	Rinse	Rinse	Rinse		31	
5	SHORT WASH			8			PreRinse	Main Wash	Rinse	Rinse	Rinse			27
6	CHINA CRYSTAL	8			PreRinse	PreRinse	PreRinse	Main Wash	Rinse	Rinse		41		
5	CHINA CRYSTAL		7	6		PreRinse	PreRinse	Main Wash	Rinse	Rinse			38	35
1	RINSE & HOLD		2		PreRinse								5	

\*Unextended times. These cycle times may be increased up to 15 minutes if necessary for your dishwasher to heat the water to proper temperature for good washability. If WASH HEAT BOOST is selected, time-maybe extended up to 30 minutes total, during POTSCRUBBER or NORMAL cycles.

## Drying Cycle Options:

HEATED DRY on. Available on all wash cycles except RINSE& HOLD. Add 30 minutes to wash cycle time.

HEATED DRY off (Energy Saver Drying). Drying heater is turned off. Dishes dry naturally.

## Temperature Sensor System

To get dishes clean and dry you need hot water. To help you get water of the proper temperature, your dishwasher has a water heating feature that automatically senses the temperature of the water in the wash cycle and heats it, if necessary, to the proper temperature. This water heating feature may allow you to turn down your household water heater and save energy if you're willing to let the dishwasher run a little longer while it heats water to the proper temperature. For good washing and drying, the entering water must be at least 120°F. To prevent dish damage, inlet water should not exceed 150°F.

---

## How to test water temperature:

Higher water temperature is needed to dissolve grease and activate powder detergents.

Check your water temperature with a candy or meat thermometer. Turn on the hot water faucet nearest the dishwasher. Put the thermometer in a glass and let the water run continuously into the glass until the temperature stops rising. If the water temperature is below 120°F.; adjust your water heater.

**Helpful hints:** If outside temperatures are unusually low, or if your water travels a long distance from water heater to dishwasher, you may need to set your water heater's thermostat up. If you have not used hot water for some time, the water in the pipes will be cold. Turn on the hot water faucet at the sink and allow it to run until the water is hot. Then start the dishwasher. If you've recently done laundry or run hot water for showers, give your water heater time to recover before operating the dishwasher. To improve washability if the water is less than 120°F. and you cannot adjust your water heater: Select a longer cycle and fill both detergent cups at least half-full with detergent.

---

## How to use a rinse agent.

A rinse agent makes water flow off dishes quicker than usual. This lessens water spotting and makes drying faster, too.

For best dishwashing performance, use of a rinse agent such as JET-DRY brand is recommended.

Rinse agents come in either liquid or solid form. Your dishwasher's dispenser uses the liquid form.

**How to fill rinse agent dispenser.** Unscrew cap. Add liquid rinse agent until it just reaches the bottom of lip inside the dispenser opening. Replace cap. The dispenser automatically releases rinse agent into final rinse water.

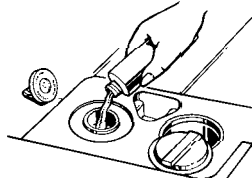

You may check to see if you need to add rinse agent by removing the fill cap and looking into the container. You may also check the rinse agent, on some models, by pressing the clear center of the fill cap 2 or 3 times. If rinse agent is drawn into the center of the fill cap, you have enough. If the center area remains clear add rinse agent.

Your dishwasher's rinse agent container holds 4½ ounces. This should last about 3 months. Fill as needed. Do not overfill.

**If you accidentally spill:** Wipe up the rinse agent with a damp cloth. Don't leave the spill in the dishwasher. It can keep your detergent from working

**If you can't find any rinse agent, write:**

BENCKISER CONSUMER  
PRODUCTS, INC.  
("JET DRY")  
55 Federal Rd.  
P.O. Box 1991  
Danbury, CT. 06313-1991

---

## How to choose and use the right detergent.

**First, use only powder or liquid detergent specifically made for use in dishwashers. Other types will cause oversudsing.**

**Second, check the phosphate content.** Phosphate helps prevent hard-water materials from forming spots or film on your dishes. If your water is hard (7 grains or more), your detergent has to work harder. Detergents with a higher phosphate level will probably work better. If the phosphate content is low (8.7% or less), you'll have to use extra detergent with hard water.

**Your water department can tell you how hard your water is.** So can your county extension agent or your area's water softener company. Just call and ask them how many "grains of hardness" are in your water.

**How much detergent should you use?** That depends. Is your water "hard" or "soft"? With hard water, you need extra detergent to get dishes clean. With soft water, you need less detergent.

*(continued next page)*

# OPERATING INSTRUCTIONS

(continued)

## How to choose and use the right detergent. (continued)

Too much detergent with soft water not only wastes money, it can be harmful. It can cause a permanent cloudiness of glassware, called “etching.” An outside layer of glass is etched away! Of course, this takes some time. But why take a chance when it’s easy to find out the hardness of your water?

**Keep your detergent fresh and dry.** Under the sink isn’t a good place to store detergent. Too much moisture. Don’t put powder detergent into the dispenser until you’re ready to wash dishes, either. (It won’t be fresh OR dry).

**If your powder detergent gets old or lumpy, throw it away.** Old detergent often won’t dissolve. If you use a liquid dishwasher detergent, these precautions are not necessary because liquid detergents don’t “lump” as they age or come in contact with water.

**You’ll find two detergent dispensers on the inside door of your dishwasher.**

Two, because some cycles use two washes.

See “*Detergent Usage Guide*” below.

Always close the main cup tightly. When it is firmly latched you will hear a clicking sound. It is not necessary to overtighten.

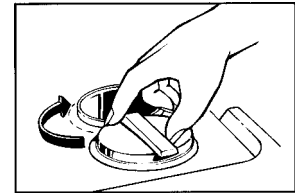
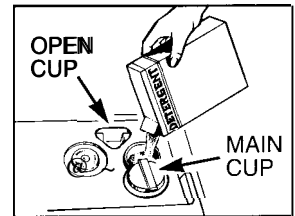

GRASP HANDLE, ROTATE AND CLOSE TIGHTLY

## Detergent Usage Guide (powder of liquid)

CYCLES	SOFT WATER (0-3 grains hardness)		MEDIUM WATER (3-7 grains)		HARD WATER (7-12 grains*)	
	Main Cup	Open Cup	Main Cup	Open Cup	Main Cup‡	Open Cup‡
POTSCRUBBER NORMAL WASH	Half Full	Half Full	Completely Full	Half Full	Completely Full	Completely Full
SHORT WASH CHINA CRYSTAL	Half Full	None	Half Full	None	Completely Full	None
RINSE & HOLD	Use no detergent		Use no detergent		Use no detergent	

\*12 grains and up is extremely hard water. A water softener is recommended. Without it, lime can build up in the water valve. The water valve may stick while open and cause flooding.

‡ Filled Main Cup holds 3 tablespoons;  
Filled Open Cup holds 2 tablespoons.

## How to Prepare the Dishes for Washing

If this is your first dishwasher, or if you’re replacing a much older model, you may wonder how much preparation your dishes need. Actually very little. Pre-rinsing of normal food soils is not necessary. With common sense and a little practice you’ll soon know what foods to remove. Here are some guidelines:

1. Scrape off bones, seeds, skins, toothpicks and other hard solids. It is also best to remove hard-shelled vegetables, meat trimmings, leafy vegetables and crusts. Remove excessive quantities of oil or grease.
2. Remove large quantities of any food. Your dishwasher has a built-in soft food disposer that pulverizes soft food bits and flushes them away. It can handle small amounts of soft foods, but large amounts will be difficult to handle.
3. Try to remove food scraps and place dishes in dishwasher before soil has a chance to dry and become hard. Dishes with dried-on soil are more difficult to wash and may not come clean in the NORMAL WASH cycle. Remember to use your RINSE & HOLD cycle for small “holding” loads.

**NOTE:** The foods mentioned are examples only. Other foods not mentioned may also need to be removed from your dishes. You may also want to consider removing foods such as mustard, mayonnaise, vinegar, lemon juice and other foods that can cause discoloration of stainless steel if allowed to remain on dishes for a long period.

**When using the POTSCRUBBER cycle,** less preparation is required before loading. The POTSCRUBBER cycle can wash heavily-soiled dishes and remove dried-on and baked-on soils from pots, pans and casseroles. Items with burned-on soils may not come clean and the dishwasher cannot remove burn marks or restore fading caused by overheating during cooking.

# HOW TO LOAD YOUR DISHWASHER

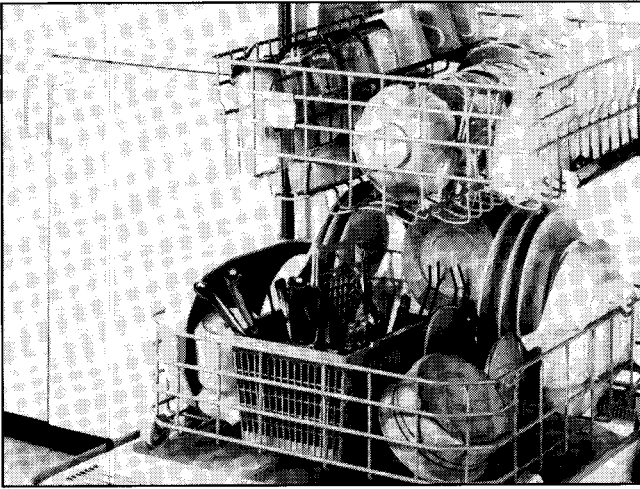

*This is a random mixed load, the most common type you will have.*

Make sure dishes are properly loaded to insure that water can reach the soiled surfaces. The wash arm in the bottom sprays water up. The tower that rises in the center sends water out over the dishes to wash the items in the upper rack. A spray arm in the top washes down also. Make sure to place tall items to the outside so the upper wash arm is not blocked.

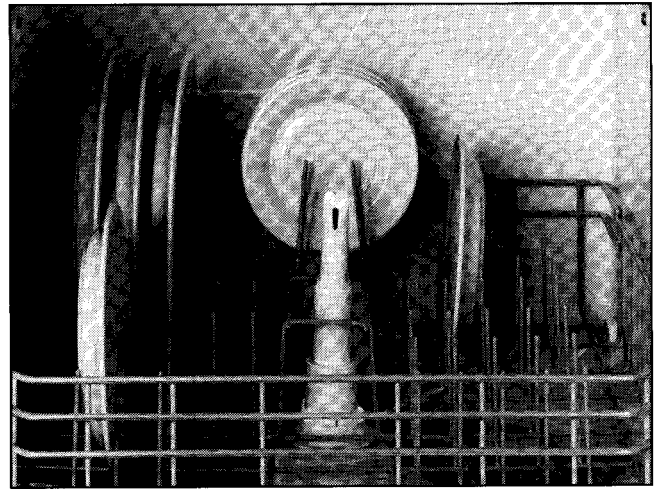

**WATCH OUT FOR THIS.**

The washer tower rises through the center of the bottom rack during the wash and rinse portions of the cycle. Don't block it or load tall things next to it. Also, be careful not to let a portion of an item such as a pot or dish handle extend through the bottom rack. This could block the wash arm and cause poor washing results.

## HOW TO LOAD THE TOP RACK

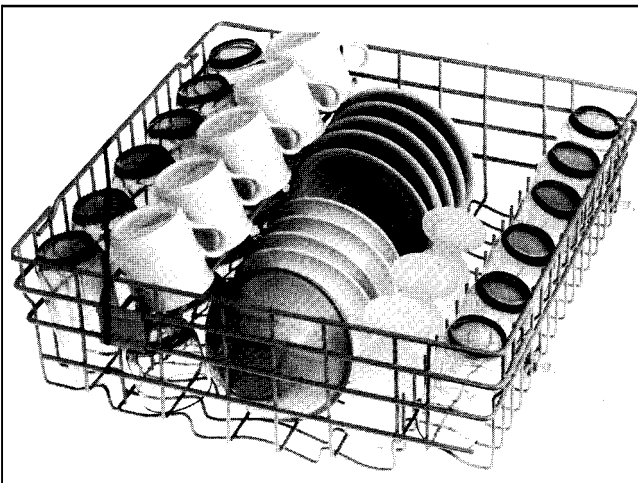

The top rack is best for glasses, cups and saucers. Cups and glasses fit best along the sides. This is the place for dishwasher-safe plastics, too. Make sure small plastic items are lodged in tightly so they can't fall onto the Calrod<sup>®</sup> heating element. Arrange stemware so that it cannot move easily. Don't let the glasses touch each other.

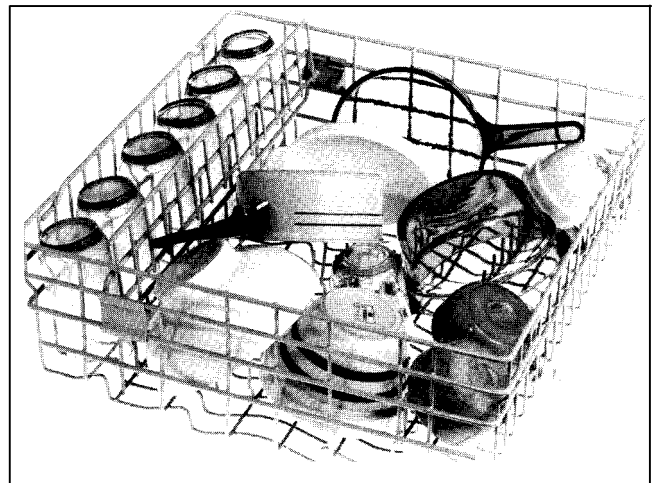

Sauce pans, mixing bowls and other small items may be placed—face down—in the top rack. The top rack is handy for all kinds of odd shapes.

*(continued next page)*

---

## HOW TO LOAD YOUR DISHWASHER

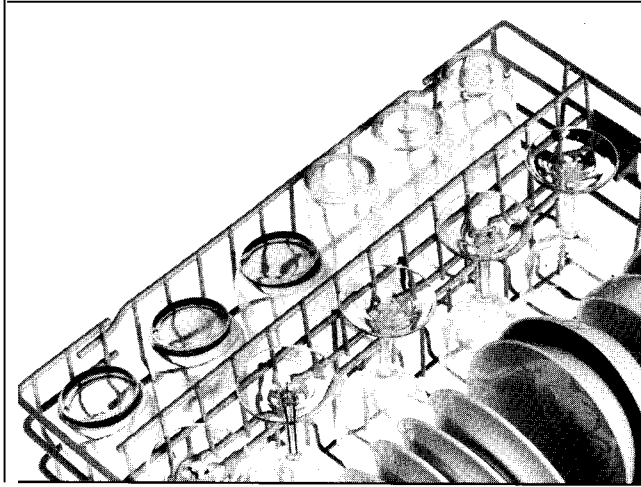

### Shelf Up

Fold the folding shelf up for glasses and tall things. Place tall items to the outside so the upper wash arm is not blocked.

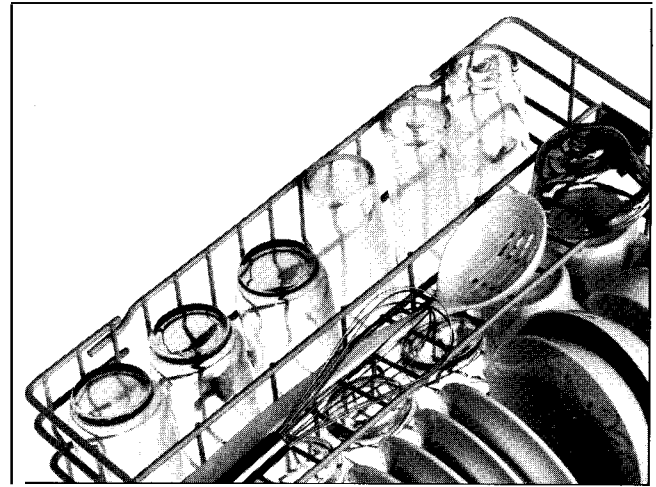

### Shelf Down

The folding shelf gives you extra space for cups and long utensils on two levels. Load the lower level first, then fold the shelf down.

---

## HOW TO LOAD THE BOTTOM RACK

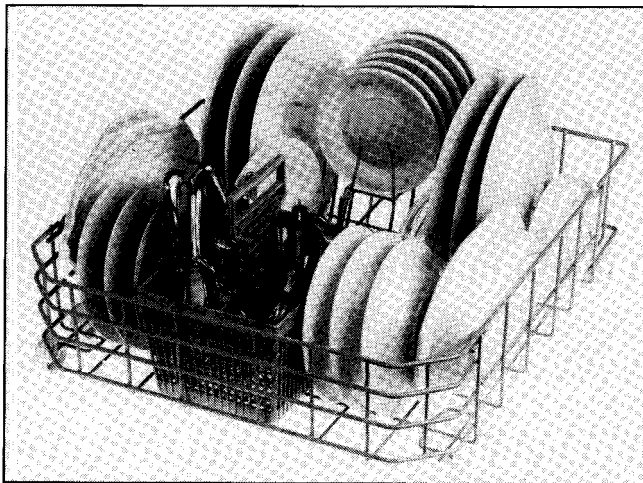

Fit plates and saucers between the pins. Load platters, pots and bowls along the sides, in corners or in the back.

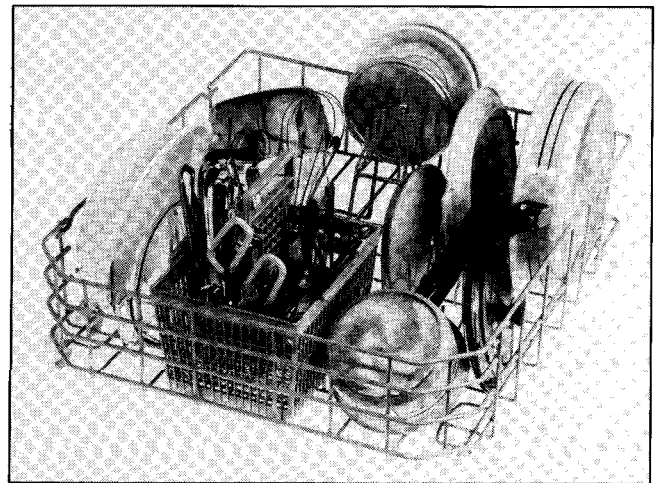

Pots, pans, casseroles, salad bowls, mixing bowls and lids **MUST** be loaded in the bottom rack, facing down.



## HOW TO LOAD THE BOTTOM RACK

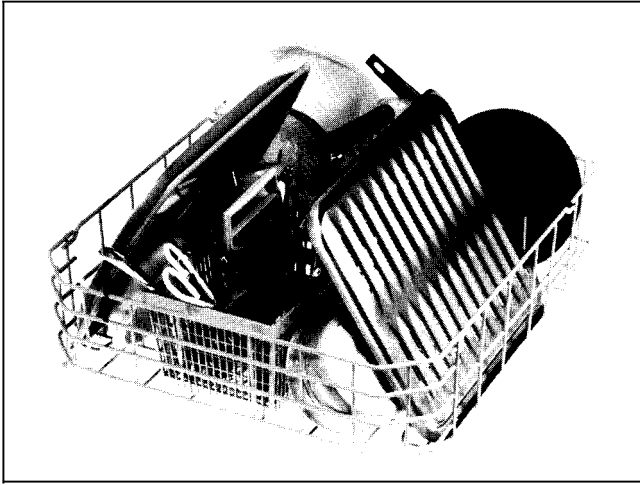

Heavily soiled pots, pans and casseroles **MUST** be loaded in the bottom rack, facing down. Prop broiler pans and racks along the edge.

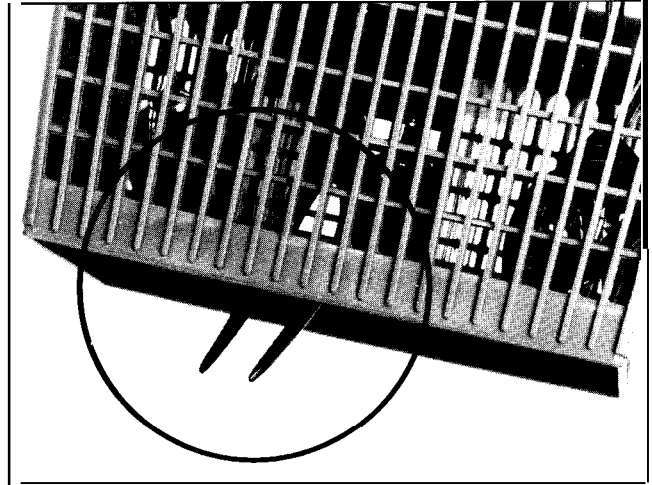

### **Precaution!**

Take out anything that may fall or extend through the bottom of the basket.



Put flatware in the removable basket with handles up to protect your hands. Mix knives, forks and spoons so they don't nest together. Distribute evenly.

The security cell cover, hinged in the handle, can be lowered to either side to secure light-weight items from the effects of the vigorous wash action. When it is not needed, this cover can remain upright.

## WHAT YOU CAN USUALLY WASH SAFELY IN YOUR DISHWASHER.

Material	Usually Safe	Exceptions (not safe)	Special Instructions
Aluminum	YES	Some colored anodized aluminum can fade.	Some darkening or spotting possible. Remove by scouring with soap-filled steel wool pads.
China/ Stoneware	YES	Antique, metal-trimmed, hand-painted or over-the-glaze patterns fade. Gold leaf will discolor.	If in doubt, check with the manufacturer. Or test wash one piece daily for at least a month. Compare with the rest of the set,
Crystal	YES	Antique, metal-trimmed or hand-painted patterns fade. Gold leaf will discolor.	Load securely to prevent movement. Select CHINA-CRYSTAL cycle. Check your manufacturer's instructions for your crystal.
Non-dishwasher items—such as electronic air cleaner filters, furnace filters, paint brushes, etc.	NO		Do not wash in dishwasher. Damage to dishwasher and discoloration or staining of dishwasher may result.
Glass	YES	Milk glass may yellow.	
Iron	NO	Iron will rust.	
Pewter	NO	Pewter tarnishes.	
Plastics	YES		If it doesn't say DISHWASHER SAFE, test one piece in the top rack before dishwashing an entire set.
Stainless steel	YES		Rinse if not washing immediately. Salty or acid foods can stain if left on.
Sterling Silver and Silver plate	YES	Don't put in same silverware basket with stainless steel. Contact between metals can damage silver. Don't wash copper utensils in the same load. Silver may get a brown film. Adhesive used to attach some hollow-handle knives can loosen	Rinse if not washing immediately. Salty or acid foods can stain if left on. Dry detergent can cause difficult-to-remove black spots. Place in back section of silverware basket to avoid exposure to detergent from the detergent cup.
Non-stick coatings	YES		After washing, wipe the non-stick coating area with vegetable oil to keep it from losing its non-stick quality
Tin	NO	Tin can rust.	
Wood	NO	Wood can warp, crack or lose its finish with any type of washing.	

### Forget a dish? Here's when you can add it.

Add dishes any time during the RINSE & HOLD cycle. With other wash cycles, you can add dishes at any time BEFORE the main detergent wash portion of the cycle.

However, opening the door during any cycle lessens cleaning power. So try to load everything at the beginning.

Here's how to add a forgotten dish:

1. Push the door latch to the left. Washing will stop.
2. Wait a few seconds until the water calms. Then open the door. **WARNING:** Hot vapor may rise from opened door.
3. Add dishes you've forgotten.
4. Close the door and push the latch to the far right. When the door is locked, washing will continue.

# CARE AND CLEANING

## USER MAINTENANCE INSTRUCTIONS

**Clean the control panel with a lightly dampened cloth.** Dry thoroughly. Do not use abrasives or sharp objects on the panel. They can damage it.

**Clean the outside with a good appliance polish wax.** The outside cabinet finish is durable, but it can scratch. So use no scouring pads, or harsh or gritty cleaners.

Appliance Polish Wax & Cleaner (Cat. No. WR97X0216) is available from GE Appliance Parts Marts.

**The inside usually takes care of itself.** If it should ever need cleaning, use a mild cleansing powder. Scouring pads and harsh cleaners can mar the finish.

## Not Using Your Dishwasher in Winter? Protect Against Freezing.

If your dishwasher is left in an unheated place during the winter, ask a service technician to:

- Cut off electrical power to the dishwasher. Remove fuses or trip circuit breaker.
- Turn off the water supply.
- Disconnect the water inlet line from the water valve.
- Drain water from the inlet line and water valve. (Use a pan to catch the water.)

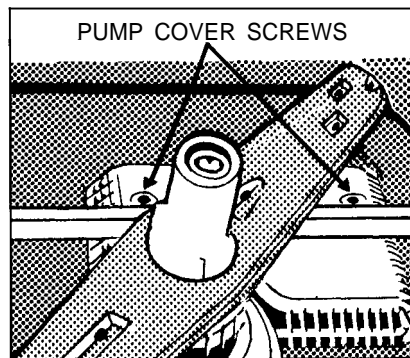

- Reconnect the water inlet line to the water valve.
- Drain the collection chamber at rear of unit below filter by disconnecting hose to pump. Reconnect after draining.
- Remove the plastic pump cover in the tub bottom and use a sponge to soak up water in the rubber boot.

## Built-in Dishwashers Often Use an Air Gap. Keep It Clean.

An air gap is a plumbing device. It protects your dishwasher against water backing up into it if a drain clogs. The air gap is not a part of the dishwasher and you may not even have one. Not all plumbing codes require air gaps.

**Check the air gap any time your dishwasher isn't draining well.**

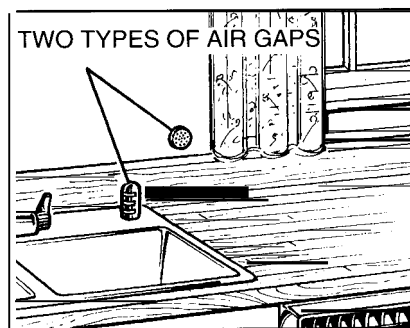

If you have an air gap, check it at least once a month. **IT IS NOT PART OF YOUR DISHWASHER. IT IS NOT COVERED IN YOUR WARRANTY.**

**The air gap is easy to clean.**

With most types, first turn off the dishwasher, then lift off the chrome cover. Then unscrew the plastic cap and check for any buildup of grit. A toothpick makes cleaning easy.

# HOW TO CHANGE COLOR PANELS

If you are redecorating, you can change your dishwasher's front panels to match or blend with your new colors.

The panels are held in place by the door trim and the trim on the panel below the door. Each side of each panel is a different color. Or you can paint a panel with the color of your own choice.

## How to Change Door Panel Insert

1. Take out trim screws on either side of the dishwasher door. Remove the side trim.
2. Slide out the insert panel.
3. Put the color you want in front. (Careful—edges may be sharp).
4. Replace the insert panel, side trim and screws.

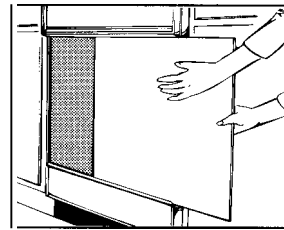

**NOTE: Do not operate dishwasher while changing panels or when lower access panel is removed.**

## How to Change Lower Panel Insert:

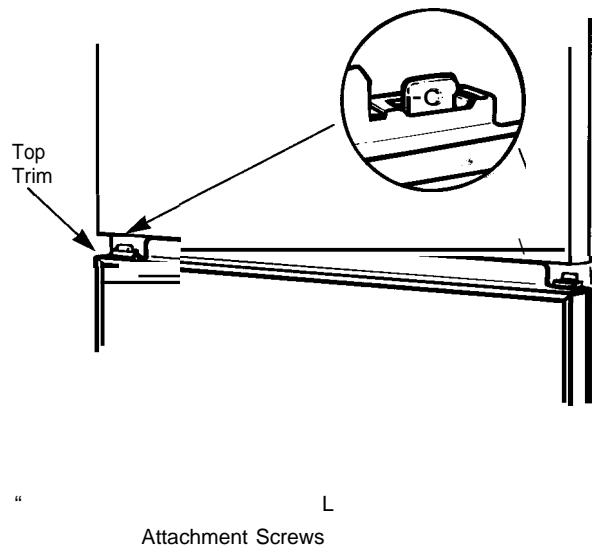

1. Remove the lower access assembly by taking out the attachment screws and then lifting it up and clear of the retaining tabs.
2. Take out the top trim screws and remove the top trim.
3. Slide the color panel (s) up and out and put the color you want in front.
4. Replace the top trim and screws.
5. Replace the entire access assembly by hanging it back on the retaining tabs and replacing the attachment screws.

## Match Your Kitchen Cabinets

Color insert panels for both the door and the lower panel can be replaced by 1/4" thick wood inserts to match your kitchen cabinets. Get them from your nearest cabinet or lumber dealer.

Dimensions for 1/4" wood inserts:

Door Panel: 19 1/8" H X 23 3/16" W.

Lower Panel: 3 1/16" H X 23 3/16" W.

# QUESTIONS? USE THIS PROBLEM SOLVER

PROBLEM	POSSIBLE CAUSE
CONTROL PANEL LIGHTS GO OFF WHEN YOU'RE SETTING CONTROLS	Time too long between touching of selected pads. Each pad must be touched within 30 seconds of the others. To relight, touch any pad again, or unlock and relatch door.
DISHWASHER WON'T RUN	A fuse in your home maybe blown, or the circuit breaker tripped. Replace fuse or reset circuit breaker. Remove any other appliances from the circuit.
UNUSUAL NOISE	<p>Utensils may not be secure on rack pins, or something small may have dropped from the rack. Water is causing utensils to rattle. Make sure everything is securely placed in dishwasher.</p> <p>Water draining out of tub immediately after you touch CLEAR RESET pad. The sounds you hear are normal ones.</p>
DISHES DON'T DRY	<p>Make sure inlet water temperature is correct. (To test, see How to Test Water Temperature section.)</p> <p>Unload the bottom rack first. Water from dishes in the top rack maybe spilling onto the bottom rack.</p> <p>Check for improper loading. Dishes shouldn't nest together. Avoid overloading.</p> <p>Check the rinse agent dispenser to see that it's not empty.</p>
UNCLEAN DISHES AND FLATWARE	<p>Check inlet water temperature. It should be at least 120°F. (To test, see How to Test Water Temperature section.)</p> <p>Water pressure may be temporarily low. Turn on a faucet. Is water coming out slower than usual? If so, wait until pressure is normal before using your dishwasher.</p> <p>Plugged air gap. (See Care and Cleaning section.)</p> <p>Improper rack loading. (See Loading section.)</p>
BLACK OR GRAY MARKS ON DISHES	Aluminum utensils often leave marks when they rub against dishes. Remove marks with a mild abrasive cleanser.
DETERGENT LEFT IN DISPENSER CUPS	<p>Water may not be reaching the detergent cups. Move dishes that may be blocking the detergent cup.</p> <p>The dispenser cover may not be opening or may be blocked by improperly loaded items. If you used a powder detergent, open the cups and remove any caked-on detergent. If the cup still doesn't open automatically, call for service.</p> <p>Detergent may be old. If the powder is hard or caked in the box, throw it away.</p> <p>The detergent may not be working well. Try another brand.</p>

*(continued next page)*

# THE PROBLEM SOLVER

(continued)

PROBLEM	POSSIBLE CAUSE
<p>SPOTS AND FILMING ON GLASSES AND FLATWARE</p>	<p>Spotting can be caused by all of these things:</p> <ul style="list-style-type: none"> <li>•Extremely hard water. (See How to Choose and Use Detergent section.)</li> <li>•Low inlet water temperature. (To test, see How to Test Water Temperature section.)</li> <li>•Overloading the dishwasher.</li> <li>• Improper loading, (See Loading section. )</li> <li>•Old or damp powder detergent.</li> <li>•Phosphate level in detergent too low. (See How to Choose and Use Detergent section.)</li> <li>• Rinse agent dispenser empty. (See How to Use a Rinse Agent section.)</li> <li>•Too little detergent. (See How to Choose and Use Detergent section.)</li> </ul> <p>Due to varying local water conditions and personal preferences, try several brands of detergents to find one that gives the best results for you. A liquid dishwasher detergent may help reduce filming.</p> <p><b>To remove spots and film from glassware:</b></p> <ol style="list-style-type: none"> <li>1. Remove all metal utensils from the dishwasher.</li> <li>2. DO NOT ADD DETERGENT.</li> <li>3. Select POTSCRUBBER cycle, LIGHT SOIL (Energy saver) SOIL OPTION and HEATED DRY off (Energy saver drying).</li> <li>4. Start the dishwasher and allow to run until “49” minutes to end of cycle is displayed.</li> <li>5. Then open the door and pour 2 cups (500ml) of white vinegar into the bottom of the dishwasher.</li> <li>6. Close the door and allow the dishwasher to complete the cycle.</li> </ol> <p><b>If vinegar rinse doesn’t work:</b> Repeat as above, except use 1/4 cup of citric acid crystals instead of vinegar. (Most drugstores carry citric acid crystals. If yours doesn’t, call General Electric Factory Service.)</p> <p>Using a vinegar or citric acid crystal rinse more than twice a month? Consider a home water softener.</p>
<p>CLOUDINESS ON GLASSWARE</p>	<p>If vinegar or citric acid crystal rinse doesn’t work, the cloudiness is “etching.” The film cannot be removed.</p> <p><b>It can be prevented:</b> Use less detergent if you have soft water. Wash glassware in the shortest cycle that will get them clean.</p> <p>Water temperature entering dishwasher exceeds 150°F.</p>
<p>YELLOW OR BROWN FILM</p>	<p>Tea or coffee can stain cups. Remove the stains by hand, using a solution of 1/2 cup bleach and 3 cups warm water.</p> <p>An overall yellow or brown film on dishes or glassware can be caused by iron deposits in water. A special filter in the water supply line is the only way to correct this problem. Your water softener company can tell you about the filter.</p> <p>Yellow film on sterling silver results when you wash copper utensils in the same load. Silver polish will usually remove this stain.</p>

<b>PROBLEM</b>	<b>POSSIBLE CAUSE</b>
CHIPPING OF CHINA	Rough handling cart cause chipping. Load with care. Make sure glassware and china are secure and can't jar loose. (See Loading section for correct way to load glassware.) Make sure tall glasses and stemware will clear the top of the tub when you push the rack into the dishwasher. Always use the top rack for delicate items.  Use the CHINA CRYSTAL cycle for fine china.
SMALL AMOUNT OF WATER STANDING IN THE BOTTOM OF THE TUB	Water around the outlet on the tub bottom at the back of the tub is normal. It is clean water. It's there to keep the water seal lubricated.
WATER WON'T PUMP OUT OF THE TUB	If the entire bottom of the tub has water, you may have a drain problem. Clean the air gap, if you have one. (See Care and Cleaning section.)  Check the kitchen sink. Is it draining well? You may need a plumber.  If dishwasher drains into a disposer, run the disposer to clear. Be sure the disposer is not clogged.  See the SYSTEMS MONITOR section.
SUDS IN THE TUB	Sudsing detergents are not meant for dishwashers. <b>USE ONLY AUTOMATIC DISHWASHER DETERGENTS TO AVOID SUDSING.</b>  <b>To remove suds from the tub:</b> Open the dishwasher. Let suds evaporate. Add 1 gallon of cold water to the tub. Close and latch the dishwasher. To pump out water, touch START two times, then immediately touch CLEAR RESET.  Repeat if necessary.
DISHWASHER LEAKS	Suds can cause unit to overflow. That's why it's so important to use a detergent that's designed for automatic dishwashers.  Spilling the rinse agent can cause foam during washing. This can lead to overflowing. (Wipe up accidental spill of rinse agent with a damp cloth.)
MOTOR HUMS	Dishwasher has not been used on a regular basis.  If you do not use your dishwasher often set it to fill and pump out once every week. This will help keep the seal moist, and the garbage disposer clear.
CONTROL PANEL DOESN'T RESPOND TO INPUTS	Shut off power to dishwasher at fuse or circuit breaker. Wait 5 seconds and restore power to dishwasher. Try input panel again.
STAINING OF TUB INTERIOR	Some detergents contain colorant (pigment or dyes) that will discolor the tub interior with extended use. Check the detergent cup for signs of any discoloration. If cup is discolored, change to detergent without any colorant.

**If you need more help... call, toll free:**  
**GE Answer Center®**  
**800.626.2000**  
**consumer information service**

---

# NOTES



---

# NOTES

---

With the purchase of your new Monogram appliance, receive the assurance that if you ever need information or assistance from GE, we'll be there. All you have to do is call—toll-free!

---

## ***In-Home Repair Service*** ***800.GE.CARES (800.432.2737)***

A GE consumer service professional will provide expert repair service, scheduled at a time that's convenient for you. Many GE Consumer Service company-operated locations offer you service today or tomorrow, or at your convenience (7:00 a.m. to 7:00 p.m. weekdays, 9:00 a.m. to 2:00 p.m. Saturdays). Our factory-trained technicians know your appliance inside and out—so most repairs can be handled in just 1 visit.

---

## ***GE Answer Center<sup>®</sup>*** ***800.626.2000***

Whatever your question about any Monogram major appliance, GE Answer Center<sup>®</sup> information service is available to help. Your call—and your question—will be answered promptly and courteously. And you can call any time. GE Answer Center<sup>®</sup> service is open 24 hours a day, 7 days a week.

---

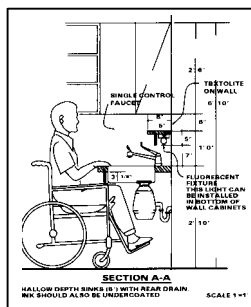

## ***For Customers With Special Needs...*** ***800.626.2000***

Upon request, GE will provide Braille controls for a variety of Monogram appliances, and a brochure to assist in planning a barrier-free kitchen for persons with limited mobility. To obtain these items, free of charge, call 800.626.2000.

Consumers with impaired hearing or speech who have access to a TDD or a conventional teletypewriter may call 800-TDD-GEAC (800-833-4322) to request information or service.

---

## ***Service Contracts*** ***800.626.2224***

You can have the secure feeling that GE Consumer Service will still be there after your warranty expires. Purchase a GE contract while your warranty is still in effect and you'll receive a substantial discount. With a multiple-year contract, you're assured of future service at today's prices.

---

## ***Parts and Accessories*** ***800.626.2002***

Individuals qualified to service their **own** appliances can have needed parts or accessories sent directly to their home. The GE parts system provides access to over 47,000 parts... and all GE Genuine Renewal<sup>®</sup> Parts are fully warranted. VISA, MasterCard and Discover cards are accepted.

User maintenance instructions contained in this **booklet** cover procedures intended to be performed by any user. Other servicing generally should be referred to qualified service personnel. Caution must be exercised, since improper servicing may cause unsafe operation.

---

# YOUR MONOGRAM DISHWASHER WARRANTY

Staple sales slip or cancelled check here. Proof of original purchase date is needed to obtain service under warranty.

## WHAT IS COVERED

### FULL ONE-YEAR WARRANTY

For one year from date of original purchase, we will provide, free of charge, parts and service labor in your home to repair or replace *any part of the* dishwasher that fails because of a manufacturing defect.

### LIMITED SECOND-YEAR PARTS WARRANTY

For the second year from date of original purchase, we will provide, free of charge, replacement parts for *any part of the* dishwasher that fails because of a manufacturing defect. You pay for the service trip to your home and service labor charges.

### LIMITED FIVE-YEAR RACK/ELECTRONIC PARTS WARRANTY

For five years from date of original purchase, we will provide, free of charge, replacement parts for any

• *rack* that rusts because of a manufacturing defect

or any

• *electronic control* module that fails because of a manufacturing defect.

You pay for the service trip to your home and service labor charges.

### FULL TWENTY-YEAR TUB/DOOR LINER WARRANTY

For twenty years from date of original purchase, we will provide, free of charge, parts and service labor in your home to repair or replace *the PermaTuf® tub or door liner* if it fails to contain water because of a manufacturing defect.

This warranty is extended to the original purchaser and any succeeding owner for products purchased for ordinary home use in the 48 mainland states, Hawaii and Washington, D.C. In Alaska the warranty is the same except that it is **LIMITED** because you must pay to ship the product to the service shop or for the service technician's travel costs to your home.

All warranty service will be provided by our Factory Service Centers or by our authorized Customer Care® servicers during normal working hours.

Should your appliance need service, during warranty period or beyond, call 800-GE-CARES (800-432-2737).

## WHAT IS NOT COVERED

• Service trips to your home to teach you how to use the product.

Read your Use and Care material. If you then have any questions about operating the product, please contact your dealer or our Consumer Affairs office at the address below, or call, toll free: GE Answer Center® 800.626.2000 consumer information service

• Improper installation.

If you have an installation problem, contact your dealer or installer. You are responsible for providing

adequate electrical, plumbing, and other connecting facilities.

• Replacement of house fuses or resetting of circuit breakers.

• Cleaning or servicing of air gap device in drain line.

• Failure of the product if it is used for other than its intended purpose or used commercially.

• Damage to product caused by accident, fire, floods or acts of God.

**WARRANTOR IS NOT RESPONSIBLE FOR CONSEQUENTIAL DAMAGES.**

Some states do not allow the exclusion or limitation of incidental or consequential damages, so the above limitation or exclusion may not apply to you. This warranty gives you specific legal rights, and you may also have other rights which vary from state to state. To know what your legal rights are in your state, consult your local or state consumer affairs office or your state's Attorney General.

**Warrantor: General Electric Company**

**If further help is needed concerning this warranty, write:  
Manager—Consumer Affairs, GE Appliances, Louisville, KY 40225**



*Monogram™*

---

General Electric Company  
Louisville, KY 40225

Pub. No. 49-5634  
Part No. 165 D3080P326  
11-93 CG

## Free Manuals Download Website

<http://myh66.com>

<http://usermanuals.us>

<http://www.somanuals.com>

<http://www.4manuals.cc>

<http://www.manual-lib.com>

<http://www.404manual.com>

<http://www.luxmanual.com>

<http://aubethermostatmanual.com>

Golf course search by state

<http://golfingnear.com>

Email search by domain

<http://emailbydomain.com>

Auto manuals search

<http://auto.somanuals.com>

TV manuals search

<http://tv.somanuals.com>