

Monogram.

Use and Care Guide

for JET343G *b-22*

Microwave/Convection Oven

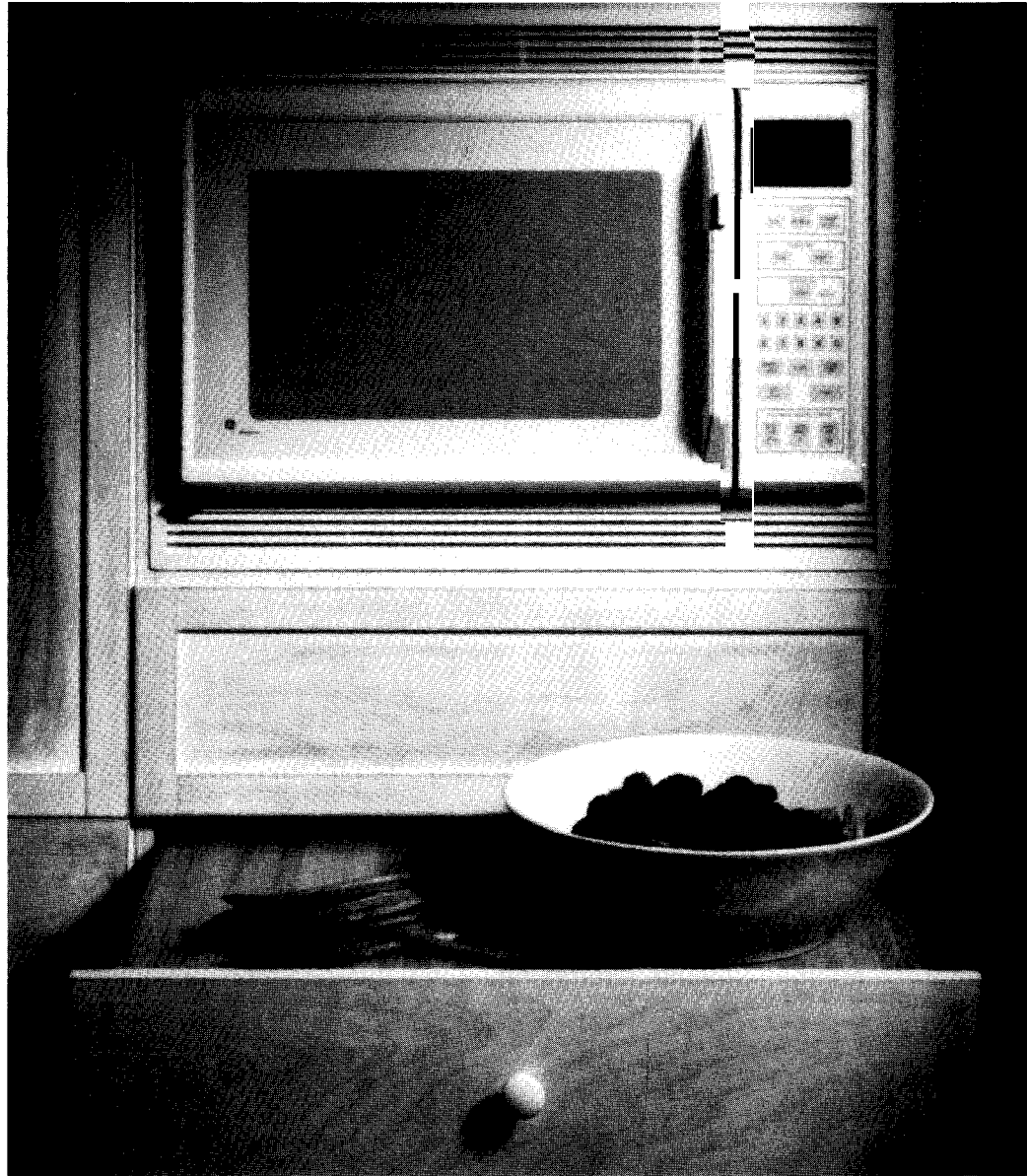

*1992 Monogram.™*

*Microwave/Convection Oven*

## Introduction

Your new Monogram microwave/convection oven makes an eloquent statement of style, convenience and kitchen planning flexibility. Whether you chose it for its purity of design, practical cooking features or assiduous attention to detail—or for all of these reasons—you'll find that your Monogram microwave/convection oven's superior blend of form and function will delight you for years to come.

The Monogram microwave/convection oven was designed to provide the flexibility to blend in with your kitchen cabinetry.

The information on the following pages will help you operate and maintain your microwave/convection oven properly.

### Optional Accessory

An Installation Kit is available at extra cost from your Monogram supplier.

**JX16W Installation Kit** converts this oven to a built-in wall oven.

This can be obtained from a Monogram dealer. For a listing of dealers—or if you have other questions—please call the GE Answer Center® (800.626.2000).

## Contents

Adapter Plugs .....	31	Cooking by Temperature	20,21
Aluminum Foil .....	5, 27-29	Cooking by Time .....	19, 20
Appliance Registration .....	3	Defrosting by Time .....	18, 19
Auto Start .....	16	Microwaving Tips .....	6
Care and Cleaning .....	30	Minute/Second Timer .....	16
Clock .....	8	Power Levels .....	8, 9, 11, 12, 17-21
Combination Cooking.....	24-27	Model and Serial Number	
Auto Roast .....	26, 27	Location .....	3
Cooking by Temperature.....	25	Oven Lamp Replacement .....	32
Cooking by Time .....	24	Oven Shelf .....	5-7, 10
Consumer Services .....	34	Precautions to Avoid Possible	
Control Panel .....	7, 8	Exposure to Excessive Microwave	
Convection Cooking .....	7-10, 22, 23, 28, 29	Energy .....	3
Broiler Pan .....	6, 7, 10, 28-30	Problem Solver .....	33
Broiling .....	28, 29	Safety Instructions .....	4-6
Cooking by Temperature.....	23	Temperature Probe .....	5, 7, 20, 21, 23, 25-27, 30
Cooking by Time .....	22	Warranty .....	35
Extension Cords.....	32	What Your Oven Can Do.....	9
Features .....	7	<b>Questions?</b>	
Grounding Instructions .....	31, 32	<b>Call GE Answer Center</b>	
Installation .....	31, 32	<b>800.626.2000</b>	
Microwave Cooking..	6, 8, 9, 11-21		
Auto Cook .....	11		
Auto Defrost .....	17		
Automatic Cooking Control			
Guide .....	13-15		

**Microwave power output  
of this oven is 800 watts.**

**(IEC-705 Test Procedure)**

---

## Before using your oven, read this book carefully.

It is intended to help you operate and maintain your new microwave oven properly. Keep it handy for answers to your questions.

If you don't understand something or need more help, write (include your phone number):

Consumer Affairs  
GE Appliances  
Appliance Park  
Louisville, KY 40225

## Write down the model and serial numbers.

You'll find them on a label on the left side wall of the control panel seen when the door is open. These numbers are also on the Consumer Product Ownership Registration Card that came with your microwave oven. Before sending in this card, please write these numbers here:

---

Model Number

---

Serial Number

Use these numbers in any correspondence or service calls concerning your microwave oven.

---

## If you received a damaged oven...

Immediately contact the dealer (or builder) that sold you the oven.

## Save time and money. Before you request service...

Check the Problem Solver in this book. It lists causes of minor operating problems that you can correct yourself.

---

## Be sure your microwave oven is registered.

It is important that we know the location of your microwave oven should a need occur for adjustments.

Your supplier is responsible for registering you as the owner. Please check with your supplier to be sure he has done so; also send in your Consumer Product Ownership Registration Card. If you move, or if you are not the original purchaser, please write to us, stating model and serial numbers.

This appliance must be registered. Please be certain that it is.

Write to: GE Appliances, Range Product Service, Appliance Park, Louisville, KY 40225

## Precautions to Avoid Possible Exposure to Excessive Microwave Energy

**(a) Do Not Attempt** to operate this oven with the door open since open-door operation can result in harmful exposure to microwave energy. It is important not to defeat or tamper with the safety interlocks.

**(b) Do Not Place** any object between the oven front face and the door or allow soil or cleaner residue to accumulate on sealing surfaces.

**(c) Do Not Operate** the oven if it is damaged. It is particularly important that the oven door close properly and that there is no damage to the:

- (1) door (bent)
- (2) hinges and latches (broken or loosened)
- (3) door seals and sealing surfaces.

**(d) The Oven Should Not** be adjusted or repaired by anyone except properly qualified service personnel.

## If you need service...

To obtain service, see the Consumer Services page in the back of this book.

We're proud of our service and want you to be pleased. If for some reason you are not happy with the service you receive, here are three steps to follow for further help.

**FIRST**, contact the people who serviced your appliance. Explain why you are not pleased. In most cases, this will solve the problem.

**NEXT**, if you are still not pleased, write all the details—including your phone number—to:

Manager, Consumer Relations, GE Appliances  
Appliance Park, Louisville, KY 40225

**FINALLY**, if your problem is still not resolved, write:

Major Appliance Consumer Action Panel  
20 North Wacker Drive, Chicago, IL 60606

# IMPORTANT SAFETY INSTRUCTIONS

## Read all instructions before using this appliance.

When using electrical appliances, basic safety precautions should be followed, including the following:

**⚠ WARNING**—To reduce the risk of burns, electric shock, fire, injury to persons or exposure to excessive microwave energy:

- Read and follow the specific “Precautions to Avoid Possible Exposure to Excessive Microwave Energy” on previous page.
  - This appliance must be grounded. Connect only to properly grounded outlet. See “Grounding Instructions” in the table of contents.
  - Use this appliance only for its intended use as described in this manual. Do not use corrosive chemicals or vapors in this appliance. This microwave/convection oven is specifically designed to heat or cook food, and is not intended for laboratory or industrial use.
  - For best operation, plug this appliance into its own electrical outlet, to prevent flickering of lights, blowing of fuse or tripping of circuit breaker.
- 
- Do not mount this appliance over a sink. Install or locate this appliance only in accordance with the provided Installation Instructions.
  - Be certain to place the front surface of the door three inches or more back from the countertop edge to avoid accidental tipping of the appliance in normal usage.
  - Do not cover or block **any** openings on the appliance.
  - Do not store this appliance outdoors. Do not use this product near water—for example, in a wet basement, near a swimming pool or near a sink.
  - \* **Do** not operate any heating or cooking appliance beneath this microwave oven.
  - Do not mount the microwave oven over or near any portion of a heating or cooking appliance.
  - Do not store anything directly on top of the microwave oven surface when the microwave oven is in **operation**.
  - Do not immerse power cord or plug in water.
  - Keep power cord away from heated surfaces,

- Do not let power cord hang over edge of table or counter.
- Do not operate this appliance **if** it has a damaged power cord **or** plug, if it is **not** working properly, or if it has been damaged or dropped.
- See door surface cleaning instructions in the Care and Cleaning section(s) of your book.
- This appliance **should** be serviced only by qualified service personnel. Contact nearest authorized service facility for examination, repair or adjustment.
- As with any appliance, close supervision is necessary when **used** by children.

- 
- To reduce the risk of fire in the oven cavity:
    - Do not overcook food. Carefully attend appliance if paper, plastic or other combustible materials are placed inside the oven to facilitate cooking.
    - Remove wire twist-ties from paper or plastic bags before placing bags in oven.
    - Do not use your microwave/convection oven to dry newspapers.
    - Do not use recycled paper products. Recycled paper towels, napkins and waxed paper can contain metal flecks which may cause arcing or ignite. Paper products containing nylon or nylon filaments should be avoided, as they may also ignite.
    - Do not pop popcorn in your microwave oven unless in a special microwave popcorn accessory or unless you use popcorn labeled for use in microwave ovens.
    - Do** not overcook potatoes. They could dehydrate and catch fire, causing damage to your oven.
    - Do not operate the oven in microwave or combination modes while empty to avoid damage to the oven and the danger of fire. If by accident the oven should run empty a minute or two, no harm is done. However, try to avoid operating the oven empty at all times—it saves energy and prolongs the life of the oven.
  - Do not use the oven for storage purposes. Do not leave paper products, cooking utensils or food in the oven when not in use.

---

## IMPORTANT SAFETY INSTRUCTIONS

\* **If** materials inside oven should ignite, keep oven door closed, turn oven off, and disconnect power cord, or shut off power at the fuse or circuit breaker panel.

---

- Some products such as whole **eggs** and sealed containers—for example, closed glass jars—will explode and should not be heated in this microwave oven. Such use of the microwave/convection oven could result in injury.
- Avoid heating baby food in glass jars, even without their lids; especially meat and egg mixtures.
- When using the convection or combination cooking functions, both the outside and inside of the oven will become hot. Always use hot pads to remove containers of food and accessories such as broiler pan, oven shelf and temperature probe.
- Do not use paper products when the microwave convection oven is operated in the convection or combination mode.
- **Don't** defrost frozen beverages in narrow necked bottles (especially carbonated beverages). Even if the container is opened, pressure can build up. This can cause the container to burst, possibly resulting in injury.
- Use metal only as directed in this book. TV dinners may be microwaved in foil trays less than 3/4" high; remove top foil cover and return tray to oven.
- Thermometer—Do not use regular cooking or oven thermometers when cooking by microwave or combination. The metal and mercury in these thermometers could cause “arcing” and possible damage to the oven. Do not use a thermometer in food you are microwaving unless the thermometer is designed or recommended for use in the microwave oven.
- Remove the temperature probe from the oven when **not using** it to cook **with**. If you leave the probe inside the oven without inserting it in food or liquid, and turn on microwave energy, it can create electrical arcing in the oven, damage oven walls and damage the temperature probe.
- Plastic cookware—Plastic cookware designed for microwave cooking is very useful, but should be used carefully. Even microwave-safe plastic may not be as tolerant of overcooking conditions as are glass or ceramic materials and may soften or char if subjected to short periods of overcooking. In longer exposures to overcooking, the food and cookware could ignite. For these reasons: 1) Use microwave-safe plastics only and use them in strict compliance with the cookware manufacturer's recommendations. 2) Do not subject empty cookware to microwaving. 3) Do not permit children to use plastic cookware without complete supervision.

---

When cooking pork, follow the directions exactly and always cook the meat to an internal

# IMPORTANT SAFETY INSTRUCTIONS

(continued)

- \* **Not all plastic wrap is suitable for use in microwave ovens.** Check the package for proper use



\* **Spontaneous boiling**—Under certain special circumstances, liquids may start to boil during or shortly after removal from the microwave oven. To prevent burns from splashing liquid, stir the liquid briefly before removing the container from the microwave oven.

- **“Boilable” cooking pouches and tightly closed plastic bags** should be slit, pierced or vented as directed by package. If they are not, plastic could burst during or immediately after cooking, possibly resulting in injury. Also, plastic storage containers should be at least partially uncovered because they form a tight seal. When cooking with containers tightly covered with plastic wrap, remove covering carefully and direct steam away from hands and face.



• **Hot foods and steam** can cause burns. Be careful when opening any containers of hot food, including popcorn bags, cooking pouches and boxes. To prevent possible injury, direct steam away from hands and face.

- \* **Use of the shelf accessory.** (See the Cookbook for proper use).
  - Remove the shelf from oven when not in use,
  - Do not store or cook with shelf on floor of oven. Product damage may result.
  - Use pot holders when handling the shelf and cookware. They may be hot.
  - Do not use microwave browning dish on shelf. The shelf could overheat.
  - Use the shelf only when cooking on two levels.
  - Be sure that the shelf is positioned properly inside the oven to prevent product damage.
  - Do not use the broiler pan or spatter shield while microwaving.
- **Use of the broiler pan**—When inserting the broiler pan, make sure that the two stop-locks on the bottom of the drip pan are inserted in the oven first so that these stop-locks properly lock the broiler pan onto the guides on the oven side walls. When properly inserted, the word “FRONT,” stamped into the bottom of the drip pan, will be towards the leading edge of the pan as you pull it out of the oven.

## SAVE THESE INSTRUCTIONS

## MICROWAVING TIPS

- **Make sure all cookware used in your microwave oven is suitable for microwaving.** Most glass casseroles, cooking dishes, measuring cups, custard cups, pottery or china dinnerware which does not have metallic trim or glaze with a metallic sheen can be used. Some cookware is labeled “suitable for microwaving.”
- **If you are not sure if a dish is microwave-safe,** use this test: Place in the oven both the dish you are testing and a glass measuring cup filled with one cup of water—set the measuring cup either in or next to the dish. Microwave 1 minute at high. If the dish

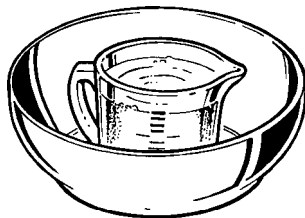

- heats, it should not be used for microwaving. If the dish remains cool and only the water in the cup heats, then the dish is microwave-safe.
- **Paper towels, waxed paper and plastic wrap** can be used to cover dishes in order to retain moisture and prevent spattering. Be sure to vent plastic wrap so steam can escape.
  - **Some microwaved foods require stirring, rotating or rearranging.** Check the Cookbook supplied.
  - **Steam builds up pressure in foods which are tightly covered by a skin or membrane.** Pierce potatoes, egg yolks and chicken livers to prevent bursting.

If you use a meat thermometer while cooking, make sure it is safe for use in microwave ovens.

# FEATURES OF YOUR OVEN

## When You Plug in the Oven

The panel displays four 8's on the upper portion and all of the oven functions on the lower portion. After 15 seconds, all lights disappear and "PF" comes on in the upper portion. Touch the CLEAR/OFF pad and oven is ready for use and the clock can be set.

If power is disrupted at any time, the above sequence recurs, and you must reset Clock after touching CLEAR/OFF.

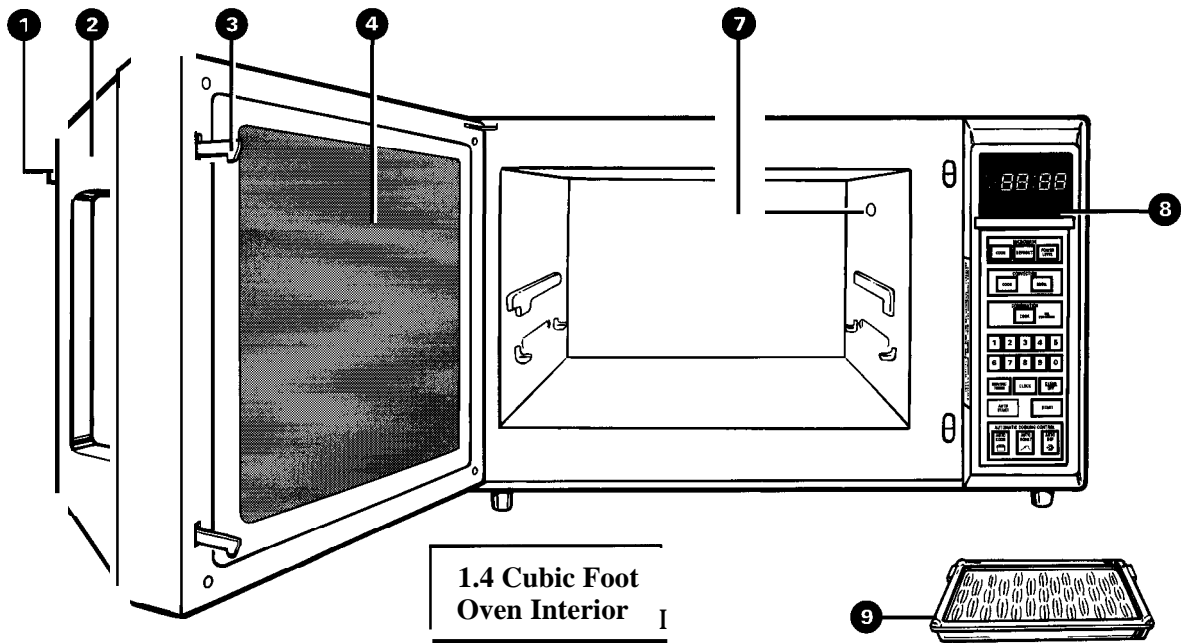
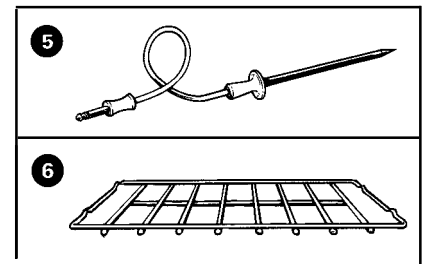

- 1. Door Latch.** Push in to open door.
- 2. Door Handle.** Door must be securely latched for oven to operate.
- 3. Door Safety Lock System.**
- 4. Window with Metal Shield.** Screen allows cooking to be viewed while keeping microwaves confined in oven.
- 5. Temperature Probe.** Probe measures internal food temperature. Must be used when cooking by temperature in microwave, convection or combination modes and with Auto Roast function.
- 6. Oven Shelf.** Use with convection, combination and some microwave recipes.

- 7. Receptacle for Temperature Probe.** Probe must be securely inserted into receptacle before oven will start any temperature cooking.
- 8. Touch Control Panel.** Use touch controls to set all oven functions. Further detailed explanation is shown on following page.
- 9. Broiler Pan and Spatter Shield.** See Convection Broiling section for instructions.

**NOTE:** Oven light and oven vent(s) are located on the inside walls of the microwave oven. Rating plate is located on the left side wall of the control panel seen when the door is open.

## All These Things are Normal With Your Microwave Oven:

- Dimming oven light and change in blower sound may occur while operating at power levels other than high.
- Dull, thumping sound while oven is operating.
- Some TV-Radio interference might be noticed while using your microwave oven. It's similar to the interference caused by other small appliances and does not indicate a problem with your oven.
- Steam or vapor escaping from around the door.
- Light reflection around door or outer case.
- During cooking you will hear "cracking" and "popping" noises which are nothing more than normal expansion of the oven.
- At the end of microwave cycles you will hear a slight thump. This is normal.

# YOUR TOUCH CONTROL PANEL

The touch control panel allows you to set the oven controls electronically with the touch of a finger. It's designed to be easy to use and understand. With your new oven, you have several cooking options. In addition to microwave or convection cooking, you have combination cooking which uses both methods. Also automatic microwave cooking (Auto Cook) and automatic microwave defrosting (Auto Defrost), and automatic combination temperature cooking (Auto Roast). Or you may make your own 2 stage programs to suit your individualized cooking needs.

1. **Display.** Displays time of day, time or temperature during cooking functions, cooking mode and pertinent instructions after setting each part of cooking steps telling you what to do next.
2. **Microwave Cook.** Touch this pad before entering microwave cooking time or temperature. Oven is programmed for power level 10 automatically but may be changed after entering time.
3. **Microwave Defrost.** Gentle thawing with little or no attention.
4. **Convection Cook.** When convection cooking, touch this pad before entering desired oven time and temperature.
5. **Combination Cook.** (See Cookbook.) Touch this pad first when using combination cooking mode.
6. **Number Pads.** Touch these pads to enter time (time of day or cooking time), internal food temperature (using probe), oven temperature, power level, or codes during Auto Cook, Auto Roast, or Auto Defrost.
7. **Min/Sec Timer.** This feature uses no microwave energy. It functions as a kitchen timer.
8. **Auto Start.** Allows you to program your oven to begin cooking at a preset time of day—up to an 1 1-hour and 59-minute delay.
9. **Auto Cook.** Touch this pad and then number pad for desired code number, and oven automatically microwaves at pre-programmed power levels and determines the proper amount of cooking times until the food is done and oven shuts off.
10. **Auto Roast.** Insert probe, touch this pad, and desired number pad for code to combination temperature cook meat with automatic preset program.
11. **Power Level.** Touch this pad before entering another power level number whenever microwave energy is being used.
12. **Broil.** Touch this pad for broiling. Be sure to use splatter shield and drip pan.

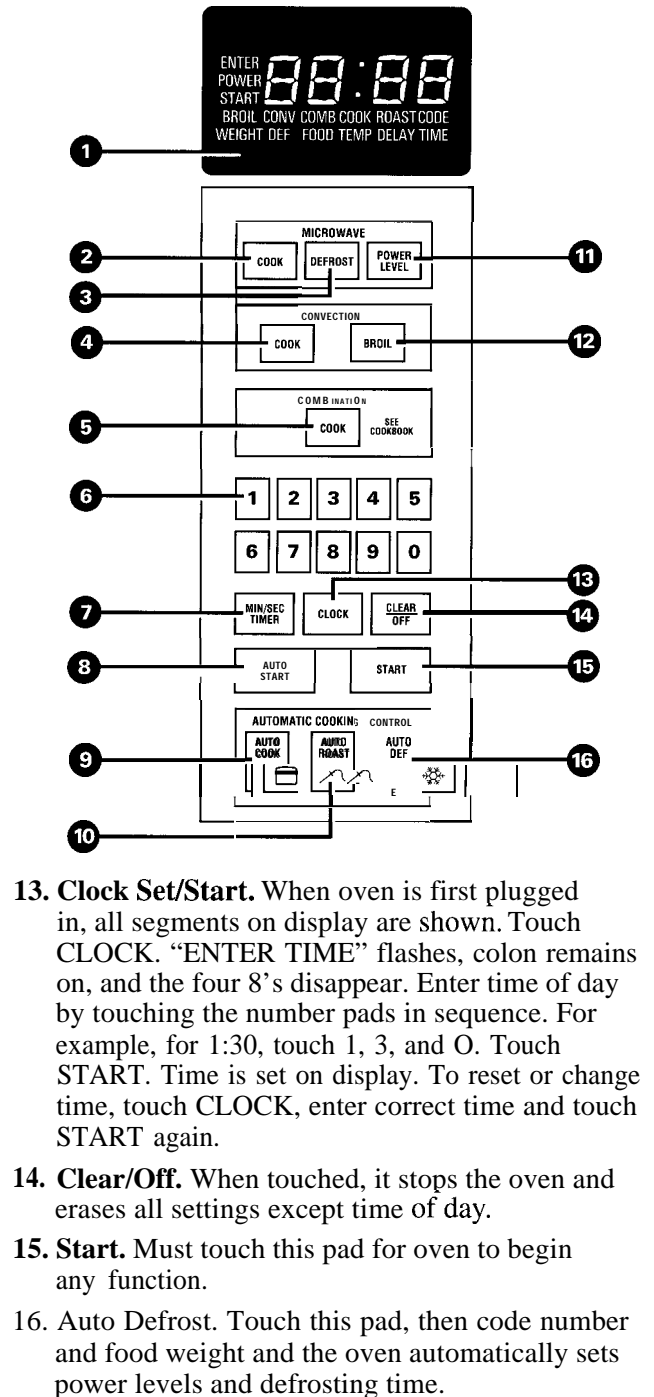



# WHAT YOUR OVEN CAN DO

Cooking with your new oven offers a wide variety of food preparation options. Microwave cooking uses very short, high frequency radio waves. The movement of the microwaves through the food generates heat and cooks most foods faster than regular methods, while retaining their natural texture and moisture. Microwave cooking heats food directly, not the cooking utensil or the interior of the oven. Reheating is easy and defrosting is particularly convenient because less time is spent in food preparation.

Convection cooking constantly circulates heated air around the food, creating even browning and sealed-in flavor by the constant motion of hot air over the food surfaces.

Your new oven also offers the option of combination cooking, using microwave energy along with convection cooking. You cook with speed and accuracy, while browning and crisping to perfection.

You can use microwave cooking, convection cooking or combination cooking to cook by time. Simply preset the length of cooking time desired and your oven turns off automatically. Or you can cook by temperature, by these methods, using the temperature probe to determine the doneness by the internal temperature of the food. This method takes the guesswork out of cooking, shutting the oven off automatically when the food reaches the desired temperature.

The Automatic Cooking Control (AUTO COOK) feature does your microwave cooking for you. It's easy and convenient—just follow the step-by-step instructions in this manual. A sensor detects steam from the food and automatically adjusts cooking time and power level for best results.



AUTO ROAST is a combination cooking function that uses the temperature probe. You simply select from 8 Auto Roast codes, and the oven automatically adjusts power level, oven temperature and internal food temperature to cook the food the way you want it.

AUTO DEFROST automatically sets the defrosting time and power levels for you. You choose the appropriate code number from 1 to 3 from the food you are defrosting, then enter the food weight in pounds and tenths of a pound and touch the START pad. The oven calculates the defrosting time and changes power levels during defrosting to give even defrosting results.

The Auto Start Timer lets you program the oven to start cooking at a desired time, even if you're not at home.

The following guide shows at a glance the difference between microwave, convection and combination cooking.

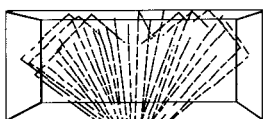
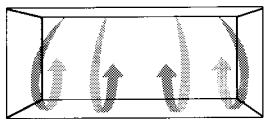
## Comparison Guide

	Microwave	Convection	Combination
			
<b>COOKING METHOD</b>	Microwave energy is distributed evenly throughout the oven for thorough, fast cooking of food.	Hot air circulates around food to produce browned exteriors and seal in juices.	Microwave energy and convection heat combine to cook foods in up to one-half the time of regular ovens, while browning and sealing in juices.
<b>HEAT SOURCE</b>	Microwave energy.	Circulating heated air.	Microwave energy and circulating heated air.
<b>HEAT CONDUCTION</b>	Heat produced within food by instant energy penetration.	Heat conducted from outside of food to inside.	Food heats from instant energy from penetration and heat conducted from outside of food.
<b>BENEFITS</b>	Fast, high efficiency cooking. Oven and surroundings do not get hot. Easy clean-up.	Aids in browning and seals in flavor. Cooks some foods faster than regular ovens.	Shortened cooking time from microwave energy, plus browning and crisping from convection heat.

Read this book to learn the many different things your Microwave/Convection/Combination Oven can do. You will find a wide variety of cooking methods and programs designed to suit your lifestyle.

# COOKWARE AND ACCESSORIES

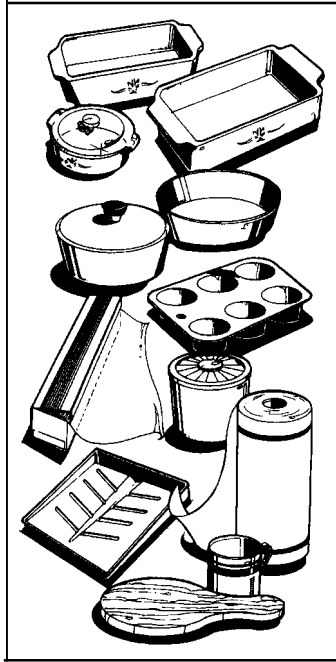

Cookware	Microwave	Convection	Combination
Heat-Resistant Glass, Glass-Ceramic (Pyrex®, Fire King®, Corning Ware®, etc.)	YES	YES	YES
Metal	NO	YES	NO
Non Heat-Resistant Glass	NO	NO	NO
Microwave-Safe Plastics	YES	NO	YES*
Plastic Films and Wraps	YES	NO	NO
Paper Products	YES	NO	NO
Straw, Wicker and Wood	YES	NO	NO

\*Use only microwave cookware that is safe to 450°F.

**NOTE:** For more information on the proper use of cookware in your oven, see your Microwave Convection Cookbook.

## Cookware Tips

### Convection Cooking

**METAL PANS** are recommended for all types of baked products, but especially where browning or crusting is important.

**Dark or dull finish metal pans** are best for breads and pies because they absorb heat and produce crisper crust.

**Shiny aluminum pans are better for cakes, cookies or muffins because these pans reflect heat and help produce a light tender crust.**

**GLASS OR GLASS-CERAMIC** casserole or baking dishes are best suited for egg and cheese recipes due to the cleanability of glass.

### Combination Cooking

**GLASS OR GLASS-CERAMIC** baking containers are recommended. Be sure not to use items with metal trim as it may cause arcing (sparking) with oven wall or oven shelf, damaging the cookware, the shelf or the oven.

**HEAT-RESISTANT PLASTIC** microwave cookware (safe to 450°F.) may be used, but it is not recommended for foods requiring crusting or all-around browning, because the plastic is a poor conductor of heat.

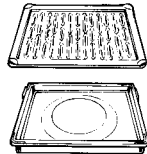
		Microwave	Convection	Combination	Broil
METAL SHELF ACCESSORY		YES <sup>1</sup>	YES	YES	NO
BROILER PAN (spatter shield and drip pan)		NO	NO	NO	YES <sup>2</sup>

<sup>1</sup>Some recipes may call for cooking on this oven shelf, but generally microwaved foods should be cooked directly on the ceramic oven floor. See Cookbook for specific instructions.

<sup>2</sup>DO NOT USE IN MICROWAVE, CONVECTION OR COMBINATION SETTING, EXCEPT WHERE NOTED IN SPECIFIC COOKBOOK RECIPES.

# AUTOMATIC MICROWAVE COOKING

Microwaving with the Auto Cook setting offers especially convenient shortcut cooking for many foods. There's no guesswork about cooking times, no need to look up suggested times in the Cookbook. Instead, a sophisticated sensing device actually detects the steam which escapes from cooking food, and automatically adjusts the oven's cooking time for various types and amounts of food.

Cooking containers must be covered during Auto Cook, so this feature is best used for foods which you wish to steam or to retain moisture. Eight Auto Cook codes let you select a cycle ideal for many frequently prepared foods. When oven senses the steam, the oven signals so that you can stir or rotate the food as directed. Once steam has been detected, the oven automatically begins counting down the remaining cooking time and adjusts power levels as needed.

## Setting the Oven Controls

**Step 1:** Place food in appropriate container and cover as directed in the Automatic Cooking Recipe Guide.



**Step 2:** Touch AUTO COOK.

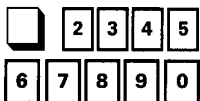

**Step 3:** Select the desired Auto Cook code by touching a number pad from 1 to 8.



**Step 4:** Touch START. **DO NOT OPEN DOOR DURING THIS TIME.** When steam is sensed, oven signals. Stir or rotate food as needed. Touch START to resume cooking. Display shows time counting down. When done, oven displays "End," signals and turns off.

**NOTE:** Oven will not accept "Auto Cook code" if the oven is hot. If "START" and "Hot" flash on display and "DELAY TIME" appears, you must cool the oven before using Auto Cook or you may choose to use time or temperature microwave cooking.

## Questions and Answers

**Q.** Would plastic storage containers with very tight-fitting lids be appropriate for Automatic Cooking?

**A.** No. Most types of plastic storage dishes, butter tubs, etc, with tight-fitting lids are not recommended for microwaving and do not allow steam to escape properly.

**Q.** When I opened the oven door to stir my food, the oven beeped and flashed "EEEE." What did I do wrong?

**A.** If the oven door is opened while "Auto" is showing in display, it will signal and flash "EEEE." Close door and touch START.

**Q.** When I tried to enter AUTO COOK, "START" and "Hot" flashed on display and "DELAY TIME" appeared. Why?

**A.** If you had previously used your oven for convection or combination cooking and its interior temperature was above 150°F, "Hot," "START DELAY TIME" and an approximate waiting time will appear on display. If you start the oven at this time, oven light will come on and cooling fan, but no cooking will begin. When oven has cooled below 150°F, you can use Auto Cook function.

**Q.** Are there some foods which do not Auto Cook well?

**A.** Yes. Puddings and sauces which require frequent stirring, candies and melted chocolate, bakery goods or other foods where a dry or crisp surface is desirable are best prepared by microwave time cooking (see the Microwave Time Cooking section). Also, extremely dry foods such as chow mein noodles or potato chips do not have enough moisture to create steam for the sensor.

---

# AUTOMATIC MICROWAVE COOKING

Automatic cooking control is a fully automatic control system that lets your microwave oven do the cooking for you. The guides in this section are designed to help you make the most of this truly new feature.

Standard cooking techniques require setting the oven for a specified cooking time or a selected finished temperature. And that means looking up recipes in a cookbook... trying to convert old recipes for microwave cooking...or just resorting to guesswork.

This control method works on an entirely different basis—with a special electronic sensor that detects steam from cooking food. The oven “knows” how the food is cooking; so it can automatically set the correct cooking time and maintain the proper power level for different types and amounts of food.

**NOTE: Oven will not accept “Auto Cook code” if the oven is hot. If the word “Hot” appears, you must cool the oven before using Auto Cook or you may choose to use time or temperature microwave cooking.**

---

## Easy to Use

Simply touch two control pads—AUTO COOK and the desired code number—and then START. Refer to cooking guide for a complete list of codes for frequently prepared foods. The display shows Auto until steam is sensed and then signals, and displays time counting down. During Auto, oven should not be opened, but when oven signals, most foods should be turned, stirred, or rotated. Check the Automatic Cooking Guide for suggestions.

Appropriate containers and coverings help assure good cooking results. Containers should match in size to the size of the food being cooked. Coverings such as plastic wrap secured on all sides, the lid that came with the container, or microwave-safe plastic domes are ideal.

---

## Foods Recommended

A wide variety of foods including meats, fish, casseroles, vegetables, leftovers, and convenience foods can be Auto cooked.

Match container size with the food, cover securely, and do not open door during Auto cycle. When oven signals, turn, rotate or stir as recommended in recipe or in the Automatic Cooking Control Guide.

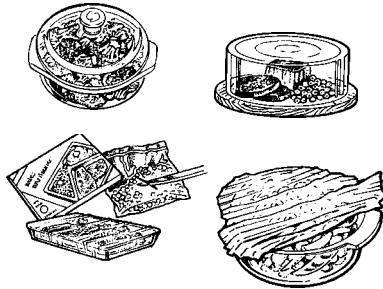

---

## Foods Not Recommended

Recipes and foods which must be cooked uncovered, or which require constant attention, or adding ingredients during cooking should be microwaved by microwave time

cooking (see Microwave Time Cooking section). For foods that microwave best using temperature probe, use Temp Cook, or Auto Roast. Foods requiring a dry or crisp surface after cooking cook best with microwave temperature cooking (see Microwave Temperature Cooking section), convection cooking (see Convection Time Cooking, Convection Temperature Cooking, and Convection Broiling sections) or combination cooking (see Combination Time Cooking, Combination Temperature Cooking, and Combination Auto Roast sections). Note the Cooking Reference Guide.

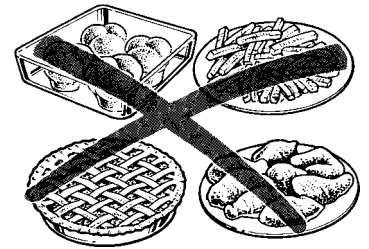

# AUTOMATIC COOKING CONTROL GUIDE

- Do not open oven door during Auto cycle. May affect cooking performance. After first beeping signal (time appears on display for codes except codes 7 and 8), stir or rotate food.
- Match the amount of food to the size of container. Fill containers at least 1/2 full.
- Add 1/4 to 1/2 cup water to fresh vegetables. Stir or turn over vegetables and meats after first beeping signal.
- Use microwave-safe plates or containers. **DO NOT USE PAPER PLATES** with Automatic Cooking.

- Be sure outside of cooking container and inside of microwave oven are dry.
- Stir or rotate after oven signals and time appears on display.

**NOTE: Oven will not accept “Auto Cook” code if the oven is hot. If the word “Hot” appears, you must cool the oven before using Auto Cook or you may choose to use time or temperature microwave cooking.**

Food	Auto Cook Code	Container	Approx. Time	Comments
<b>Reheating Food:</b>				
<b>Canned Foods</b> Room Temp. or this (small amounts at refrig. temp.)	1	Microwave-safe container matched to size of food.	3 to 4 min. per cup	Cover with lid to dish or plastic wrap.
Refrig. temp. or thick (large amounts at room temp.)	4	Microwave-safe container matched to size of food.	5 min. per cup	Cover with lid to dish or plastic wrap.
<b>Deli Foods</b>	1	Microwave-safe container matched to size of food.		Cover with lid to dish or plastic wrap.
<b>Entrees</b> Frozen Thin (under 1 inch)	6	Cook in container (see comments).	8 to 10 min.	Cover in own container, or for quicker cooking, in glass container. <b>NOTE:</b> If entree is in aluminum pan, remove from box, remove lid and put back in original closed box. If entree is in paperboard container, remove from the box and microwave with original plastic covering.
<b>Leftovers</b>	1	Microwave-safe container matched to size of food.	2 to 4 min. per cup	Use bowl with plastic wrap or cover plate with microwave-safe plastic dome.
<b>TV Dinner</b> (10 to 12 oz.)	6	Cook in container.	9 to 11 min. (see comments)	After completion of the cooking cycle, it may be necessary to stir dense foods, such as potatoes, and Microwave Cook on High (10) an additional 1 to 2 minutes. See also Frozen Entree Comments.
<b>Cooking: Casseroles</b> Precooked ingredients	4	2-qt. casserole with lid or cover with plastic wrap.	25 to 35 min.	Make sure liquid covers all ingredients. When oven signals, stir well.
<b>Chicken Breasts (4)</b> (2 to 3 servings)	4	2-qt. oblong glass baking dish. Cover with plastic wrap. <b>NOTE: Make</b> sure meat doesn't touch covering.	17 to 25 min.	No additional liquid needed. When oven signals, rotate 1/2 turn. Note the preference control 1 is used with breasts to decrease cooking time for best results.

**If after completion of Auto Cook cycle food needs additional warming, simply re-cover food and use Auto Cook code 8.**

*(continued next page)*

# AUTOMATIC COOKING CONTROL GUIDE

(continued)

Food	Auto Cook Code	Container	Approx. Time	Comments
<b>Chicken (continued)</b> <b>Pieces</b>	4	2-qt. oblong glass baking dish. Cover with plastic wrap. <b>NOTE: Make sure meat doesn't touch covering.</b>	<b>2 to 4 min. per piece</b>	No additional liquid needed. When oven signals, rotate 1/2 turn.
Whole (3 lbs.)	4	2-qt. oblong glass baking dish or cooking bag. Cover with 2 pieces of overlapping plastic wrap.	20 to 25 min.	Tie wings and legs and place on trivet. If breast bone seems prominent, a 1 inch piece of foil maybe placed over bone to prevent splitting of wrap. Rotate 1/2 turn when oven signals.
<b>Fish</b> <b>Fillets (1 lb.) Defrosted</b>	8	2-qt. oblong glass baking dish. Cover with plastic wrap.	5 to 8 min.	Baste with butter and lemon juice.
<b>Fruit</b> <b>Baked Apples (4)</b>	8	2-qt. casserole with lic	7 to 9 min.	Core apples. No water needed.
<b>Baked Pears (4)</b>	8	2-qt. casserole with lic	7 to 9 min.	No water needed.
<b>Hamburger</b> <b>Casserole, Convenience</b> (upto 3 lbs.)	6	2-qt. glass dish with lid.	13 to 18 min.	Precook ground beef. Drain. Make sure liquid covers all ingredients. When oven signals, stir well and rotate 1/4 turn.
Meat Loaf (1X lb.)	2	Glass pie plate. Cover with plastic wrap.	40 to 45 min.	
Patties (4-5)	7	8 inch square dish.	9 to 10 min.	Cover with plastic wrap.
<b>Pork</b> <b>Sausage patties</b> <b>(1/2 inch thick-4)</b>	7	8 inch glass square dish.	6 min.	Cover with plastic wrap.
<b>Chops (3/4-1 inch thick)</b>	6	2-qt. oblong glass baking dish. Cover with plastic wrap.	20 to 25 min.	Baste with 1 tablespoon barbecue sauce per chop.
Spareribs	6	3-qt. glass dish. Cover with lid or plastic wrap.	30 to 35 min.	Meat must be covered with liquid. When oven signals, rearrange meat, making sure it is submerged in liquid. It maybe necessary to rearrange another time during final cooking.
<b>Seafood</b> <b>Pieces</b> (1 lb. shrimp or scallops)	8	1 1/2-qt. glass dish.	5 to 7 min.	Cover with lid to dish.
<b>Swiss Steak</b> <b>(1 1/2 round steak)</b>	2	2-qt. oblong glass baking dish. Cover with plastic wrap.	50 to 55 min.	Cut into pieces. Make sure liquid covers all meat. When oven signals, turn over and rearrange meat.
<b>Vegetables, Fresh</b> <b>Artichokes</b> (up to 4 med.)	6	2-qt. glass dish with lid.	8 to 12 min.	Place artichokes in dish stem side down. Add 1/4 cup water. Rotate dish 1/2 turn after oven signals.
Carrots (1 lb. sliced)	5	2-qt. glass dish with lid.	10 to 15 min.	Add 1/2 cup water. When oven signals, stir well.
Cauliflower (1 med. head)	6	2-qt. glass dish with lid.	12 to 15 min.	No water needed. Start cooking stem side down.

Food	Auto Cook Code	Container	Approx. Time	Comments
<b>Vegetables, (continued) fresh</b>				
<b>Asparagus (1 lb. cut spears)</b>	6	2-qt. oblong glass baking dish. Cover with plastic wrap.	10 to 12 min.	Add 1/4 cup water. When oven signals, rotate 1/4 turn.
<b>Brussels, Sprouts (1 lb.)</b>	6	1 1/2-qt. oblong glass dish with lid.	11 min.	Add 1/4 cup water. When oven signals, rotate 1/4 turn.
Potatoes, Baked*	5	8 inch square glass dish. Cover with plastic wrap.	20 to 25 min.	When oven signals, rotate 1/2 turn. <b>NOTE: Watch hot dish and steam!</b>
2-4 (6 to 8-oz. each)	5			
<b>Frozen Block (10-oz) Broccoli</b>	6	1 1/2-qt. glass dish with lid.	18 to 20	Add 2 tablespoons water. When oven signals, stir well.
<b>Brussels Sprouts</b>	6	1 1/2-qt. glass dish with lid.	12 to 15	Add 2 tablespoons water. When oven signals, stir well.
<b>Leaf Spinach</b>	6	1 1/2-qt. glass dish with lid.	13 to 15	Add 2 tablespoons water. When oven signals, stir well.
<b>Mixed Vegetables</b>	6	1 1/2-qt. glass dish with lid.	11 to 15	Add 2 tablespoons water. When oven signals, stir well.
<b>Frozen Pouch Baby Limas</b>	6	Lay pouch in microwave-safe dish. No cover needed.	6 to 9	Make a 1 inch slit in pouch. When oven signals, break up frozen center and rotate 1/2 turn. NOTE: Watch for hot steam.
<b>corn</b>	6	Lay pouch in microwave-safe dish. No cover needed.	<b>10</b> to 12	Make a 1 inch slit in pouch. When oven signals, break up frozen center and rotate 1/2 turn. NOTE: Watch for hot steam.
<b>Peas</b>	6	Lay pouch in microwave-safe dish. No cover needed.	6 to 9	Make a 1 inch slit in pouch. When oven signals, break up frozen center and rotate 1/2 turn. NOTE: Watch for hot steam.
<b>Spinach</b>	6	Lay pouch in microwave-safe dish. No cover needed.	6 to 9	Make a 1 inch slit in pouch. When oven signals, break up frozen center and rotate 1/2 turn. NOTE: Watch for hot steam.

\*Excessively dry potatoes may not release enough moisture to activate sensor. Be sure potatoes are fresh and not old and dried-out.

## How to Adapt Microwave Casserole Recipes

Use the following step-by-step instructions and tips when adapting your casserole recipes for automatic cooking.

1. Select recipes with precooked ingredients that do not require adding ingredients at different stages during cooking or recipes that require extra attention, stirring or rotating.
2. Use microwave-safe containers that are appropriate in size to the food amount. Use 3-qt. containers or smaller.
3. For saucy casseroles, cover container with lid or plastic wrap. (No vents.) For cheese or crumb-topped casseroles, remove cover after oven signals and add topping, then continue cooking uncovered.
4. Allow precooked ingredients or hot sauces to cool slightly before adding other ingredients.
5. Meats and vegetables should be submerged in liquid.
6. After oven signals, rotate dish and stir, covering all ingredients with liquid.

---

# AUTO START

The Auto Start control on your new oven allows you to begin cooking a meal, even if you're not at home! The convenient Auto Start function lets you program a time of day, in hours and minutes to begin cooking. The oven will hold the food while counting down the selected time of day, then begin cooking after the preset time has been reached.

---

## How to Use Auto Start with a Time or Temperature Cooking Function



**Step 1:** Touch the AUTO START pad.

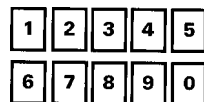

**Step 2:** Set the desired time of day by touching number pads in sequence. For example for 2:00, touch 2, 0, and 0

**Step 3:** Select the cooking function (Microwave, Convection, Combination or Auto Roast). Set the oven for that function, according to the instructions given in this book.



**Step 4:** Touch START. Correct time of day, cooking function and "DELAY TIME" appear on display. When the time of day is reached at which cooking is desired to begin, the oven signals and automatically begins the cooking function. When cooking is completed, oven displays "End," signals and turns off.

**NOTE:** Delay times up to 11 hours and 59 minutes can be programmed. Foods that spoil easily such as milk, eggs, fish, stuffings, poultry and pork should not be allowed to sit out for more than one hour. Room temperature promotes the growth of harmful bacteria.

---

# MINUTE/SECOND TIMER

The Minute/Second Timer is a minute timer. The time can range from one second to 99 minutes and 99 seconds. The Minute/Second Timer operates without microwave energy.

---

## How to Time a 3-Minute Phone Call



**Step 1:** Touch MIN/SEC TIMER pad.

**Step 2:** Touch number pads 3, 0 and 0 (for 3 minutes and no seconds).



**Step 3:** Touch START. Display shows time counting down.

**Step 4:** When time is up, oven signals and display shows time of day.

---



# AUTOMATIC DEFROSTING

With the Auto Defrost feature, the oven automatically sets the defrosting time and power levels for you. You choose the appropriate code number from 1 to 3 for the food you are defrosting, then enter the food weight in pounds and tenths of a pound (See Conversion Guide below) and touch START. The oven calculates the defrosting time and changes power levels during defrosting to give even defrosting results.

When the oven reaches one-third of the total defrosting time, the display flashes "Turn," telling you to turn food over and will not continue defrosting until door is opened and START is touched again. After defrosting time is complete, the oven automatically turns off.

## How to Set Auto Defrost

**NOTE:** Before you begin, check Cooking Guide for minimum and maximum food weights for each code number. You will need to know your food weight and corresponding code before beginning.

**NOTE:** If "EE EE" appears after entering food weight, check the Code Guide to make sure that weight corresponds to the code number entered.

**Step 1:** Remove frozen meat from package and place in microwave safe dish. Place in oven and close door.

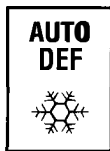

**Step 2:** Touch AUTO DEF pad.

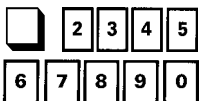

**Step 3:** Touch number pad 3.

**Step 4:** Touch number pads 3 and 0 for weight of 3 lbs.



**Step 5:** Touch START pad. WEIGHT, DEF and TIME are displayed and defrost time begins counting down.

**Step 6:** When 1/3 the defrosting time is completed, the oven signals and "Turn" flashes on display instead of time counting down. Open door and turn package over.

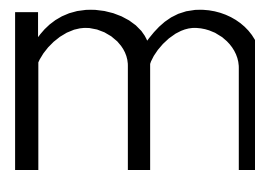

**Step 7:** Close door and touch the START pad. Display shows remaining defrosting time counting down.

**Step 8:** When defrosting time is completed the oven signals, flashes "End" and then turns off.

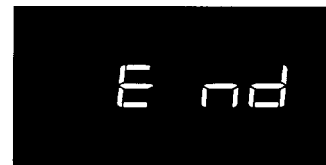

## Conversion Guide

If the weight of food is stated in pounds and ounces, the ounces must be converted to tenths (.1) of a pound.

Ounces	Pounds
1-2	.1
3	.2
4-5	.3
6-7	.4
8	.5
9-10	.6
11	.7
12-13	.8
14-15	.9

## Automatic Defrosting Guide

CODE	MIN.-MAX. WEIGHT	HOLD TIME*	RECOMMENDED FOOD
1	.5-8.0 lbs.	5-25 min.	Meat
2	.5-8.0 lbs.	5-25 min.	Poultry
3	.5-3.0 lbs.	5-15 min.	Seafood

\*In Auto Defrost, it is necessary to allow the meat to stand during holding time. You may take the meat out of the oven if you prefer. Allow a longer hold time for larger cuts of meat.

---

# DEFROSTING BY TIME

Defrosting is one of the most useful microwave functions of your oven, thawing foods quickly, but gently. With no lengthy defrosting required, meal planning is easier than ever! You can prepare single servings or whole meals ahead of time and freeze, then thaw and heat them in just minutes.

Your new oven can even be programmed to Defrost, then Time Cook for complete freezer-to-table meal preparation-automatically ! Refer to the Cookware and Accessories section of this book or to the Cookbook for cookware and food preparation tips and suggestions.

---

## Setting the Oven Controls



**Step 1:** Touch Microwave DEFROST.

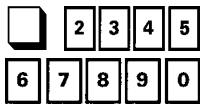

**Step 2:** Touch the number pads to enter defrosting time. For example, touch 8, 0, 0 for 8 minutes. Power level is automatically set in your oven.



**Step 3:** Touch START. When defrosting time is completed, the display shows "End," and the oven signals and shuts off.

---

## How to Microwave Defrost and Microwave Cook by Time

If you wish to defrost and then cook a particular food, follow the simple instructions below to program your oven.



**Step 1:** Touch Microwave DEFROST.

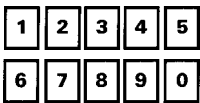

**Step 2:** Set defrosting time in minutes and seconds by touching number pads in sequence. The programmed time appears in the display.



**Step 3:** To set the time cooking stage, touch Microwave COOK.

**Step 4:** Touch the number pads to enter the cooking time. Display shows this time. Power level 10 is programmed into oven. (If power level 10 is not appropriate, see "How to Change Power Level" below.)

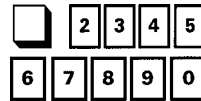

**Step 5:** Touch START. Display shows "DEF TIME" and the preset defrosting time begins counting down. When this time is completed, display shows "COOK TIME" and the cooking time begins counting down. When finished, "End" flashes, oven signals and turns off.

### How to Change Power Level

After setting cooking time, touch POWER LEVEL pad, then touch desired number for new power level. Then touch START.

---

## Questions and Answers

**Q. Why don't the defrosting times in the Cookbook seem right for my food?**

**A. Cookbook times are averages, and defrosting time required can vary according to the temperature in your freezer. Set your oven for the time given in the Cookbook. If your food is not completely thawed at the end of that time, reset the oven and adjust the time for additional defrosting.**

**Q. Can I open the door during the Microwave Defrost cycle?**

**A. Yes. You may open the door at any time during microwaving. To resume defrosting, just close the door and touch START again.**

**Q. When I defrosted hamburger patties, the edges were already cooked. Why is this?**

**A. The density and size of the food makes a difference-when defrosting. Try using the minimum recommended defrost time first. Most meat patties must be rotated during total defrosting time.**

---

## MICROWAVE TIME COOKING

**Time cooking is a familiar method of cooking food for a predetermined length of time. You will find that cooking with microwave energy takes a great deal less time than regular cooking methods. And your microwave oven, unlike many other ovens, turns itself off automatically after the preset time has elapsed.**

**You can even program your oven to Microwave Cook by time in two stages! Cook at one power level for a desired length of time; then the oven automatically changes to a different power level and continues cooking until the food is done. Check the Cookbook for foods requiring two power levels.**

---

## Setting the Oven Controls

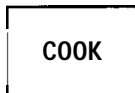

**Step 1:** Touch Microwave COOK.

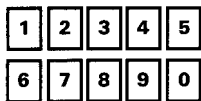

**Step 2:** Enter the cooking time in minutes and seconds. For example, touch 1, 2 and O for 1 minute, 20 seconds. When setting 1 hour and 30 minutes touch 9, 0, 0, and O. The oven is automatically set to cook at power level 10. (If power level 10 is not appropriate, see "How to Change Power Level" at right). Touch the number pad for the desired power level.



**Step 3:** Touch START. When time is up, the display shows "End," the oven signals and shuts off. If, during cooking, you wish to see what power level is being used, touch POWER LEVEL pad and the number appears momentarily.

### How to Change Power Level

After setting cooking time, touch POWER LEVEL pad, then touch desired number for new power level.

*(continued next page)*

---

# MICROWAVE TIME COOKING

(continued)

## We-Stage Microwave Time Cooking

**COOK**

**Step 1:** Touch Microwave COOK and the desired number pads for first stage cooking time, as described in Steps 1 and 2 on previous page.

**POWER LEVEL**

**Step 2:** Touch POWER LEVEL. Touch the number pad for first stage power level or oven automatically cooks at High (10).

**Step 3:** For the second cooking stage, touch Microwave COOK and the numbers for second phase cooking time. If a different power level is required, see "How to Change Power Level" at right.

### How to Change Power Level

After setting cooking time, touch POWER LEVEL pad, then touch desired number for new power level.

**START**

**Step 4:** Now touch START. First stage cooking time appears on the display counting down. **When the first stage time ends, the oven automatically changes to the second stage of cooking and power level. When cooking is finished, the display shows "End," the oven signals and turns off.**

---

## Questions and Answers

**Q. I touched the number pads to enter cooking time but nothing happened. Why?**

**A. The Microwave Cook pad must be touched before setting the number pads or the oven will not accept the number entries.**

**Q. I set my oven to Microwave COOK by time for the period in the recipe, but the food wasn't done at the end of that time. What happened?**

**A. Since house electrical power may vary, many microwave time cooking recipes give you a time range to prevent overcooking. Set the oven for the minimum time, test the food for doneness, and cook a little longer if necessary.**

---

# MICROWAVE TEMPERATURE COOKING

**Temperature cooking uses a special food thermometer to measure the internal temperature of food as it cooks. For many foods this is the best test of doneness. Heating or reheating foods accurately to the desired serving temperature is easy.**

Temperature cooking takes the guesswork out of cooking because the oven automatically switches to Hold after reaching the preset food temperature and maintains that temperature until you touch the CLEAR/OFF pad.

## The Temperature Probe

The temperature probe is a food thermometer that gauges the internal temperature of your food. (Its appearance may vary from picture at right.) The probe must be used when using Microwave Temperature Cooking, Convection Temperature Cooking, Combination Temperature Cooking and Combination Auto Roast. To use your probe properly, follow directions on the next page.

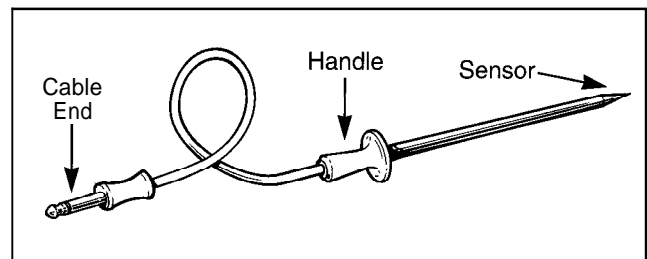

---

## Setting the Oven Controls

Step 1: Insert temperature probe in food as shown below or as described in cookbook. Plug other end of probe securely into oven wall receptacle and close oven door.



Step 2: Touch Microwave COOK.

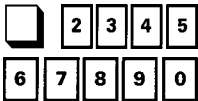

Step 3: Touch the number pads in the order you read them. For example, for 130°F., touch 1, 3, and 0.

Step 4: The oven will temperature cook automatically at power level 10, unless a different power level is selected.

### How to Change Power Level

After setting temperature cooking, touch POWER LEVEL pad, then touch desired number for new power level.



Step 5: Touch START to begin cooking. The display shows "-80" if actual food temperature is below 80°F. After 80°F. is reached, the display shows food temperature as it rises. When food reaches the preset temperature, "Hold" flashes, oven signals and holds temperature.

---

## How to Use the Temperature Probe

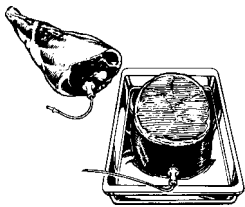

Place probe so that point rests in center of the thickest meaty part of roast, or into the cut end or meatiest part of boneless ham or lamb. Point should not touch bone, fat or gristle. For bone-in ham or lamb, insert probe into center of lowest large muscle or joint.

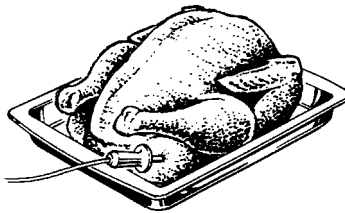

Insert probe into meatiest part of inner thigh, below and parallel to the leg of a whole turkey.

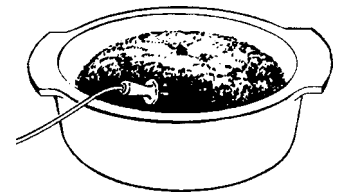

For dishes such as meat loaf or casserole, insert probe into center.

---

## Questions and Answers

**Q. Are there any foods I can't temperature cook?**

**A. Yes.** Delicate butter icings, ice cream, frozen whipped toppings, etc., soften rapidly at warm temperatures. Batters and doughs as well are difficult to cook precisely with the probe. It is best to time cook these foods. Do not use for frozen foods because probe could be damaged.

**Q. Can I leave the probe in the oven if it's not inserted in the food?**

**A. No.** If the probe is touching the oven wall, and is not inserted into food, you may damage the oven.

# CONVECTION TIME COOKING

During convection cooking, a heating element is used to raise the temperature of the air inside the oven. A fan gently circulates this heated air throughout the oven, over and around the food, producing golden brown exteriors and rich, moist interiors. Because the heated air is kept constantly moving, not permitting a layer of cooler air to develop around the food; some foods cook faster than in regular oven cooking.

**NOTE:** For information on suggested cookware, see the Cookware and Accessories section.

## How to Convection Preheat and Time Cook

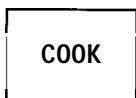

**Step 1:** Touch Convection COOK pad.



**Step 2:** Enter the oven temperature by touching the number pads that correspond with the desired oven temperature. For example, touch number pads 2, 7, and 5 for 275°F.



**Step 3:** Touch START. The selected oven temperature disappears and “-200” appears until oven temperature reaches 200°F, then displays oven temperature until preset temperature is reached. Oven signals and “ENTER CONV TIME” flashes when temperature is reached. If you do not open door within 30 minutes, the oven will turn itself off automatically.

**Step 4:** When oven is preheated, place food in oven. “Hot” appears on display when you open the door.

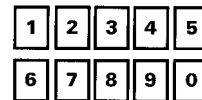

**Step 5:** Set the desired cooking time in hours and minutes by touching number pads in sequence. For example, to set 2 hours and 30 minutes, touch number pads 2, 3, and 0 in that order. To enter time less than one hour, for example, 30 minutes, touch 3 and 0.



**Step 6:** Touch START pad. The display shows remaining cooking time. If time is less than 1 hour display shows minutes and seconds. If longer, time counts down minute by minute until 59 minutes remain, then switches to display minutes and seconds. When cooking is completed, the display shows “End” and the oven signals and turns off.

## How to Convection Time Cook Without Preheating



**Step 1:** If your recipe does not require preheating, touch the Convection COOK pad.

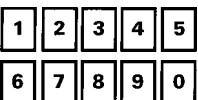

**Step 2:** Enter the oven temperature by touching the number pads that correspond to the desired oven temperature. For example, touch number pads 2, 2 and 5 for 225°F.

**Step 3:** Set the desired cooking time in hours and minutes by touching number pads in sequence. For example, to set 2 hours and 30 minutes, touch number pads 2, 3 and 0, in that order. To enter time less than one hour, for example, 30 minutes, touch 3 and 0.



**Step 4:** Touch START pad. Cooking begins and cooking time counts down as described above.

# CONVECTION TEMPERATURE COOKING

You can also convection cook with the temperature probe, to assure that foods are cooked precisely to the degree of doneness desired, while the constantly circulating hot air assures even cooking and delicious browning. The temperature probe monitors the internal temperature of the food and turns the oven off automatically when the desired temperature is reached.

## How to Convection Temperature Cook

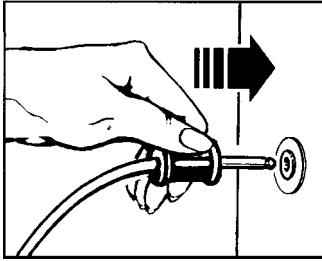

**Step 1:** Insert probe in food as directed in the Cookbook or in the Microwave Temperature Cooking section. Plug other end of probe securely into wall receptacle.



Step 2: Touch Convection COOK pad.



**Step 3:** Enter oven temperature by touching the number pads that correspond with the desired oven temperature. For example, touch 2, 2, 5 for 225°F.

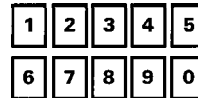

**Step 4:** Touch the appropriate number pads in sequence to enter the desired food temperature. For example, touch 1, 8 and 0, in that order, for 180°F.



**Step 5: Touch START pad.** The display shows “-80” until the food temperature reaches above 80°F., then it shows actual food temperature as it rises. When food reaches preselected temperature, display shows “End,” oven signals and turns off.

## Questions and Answers

**Q.** After I preheated my oven, I tried to set cooking time, but nothing happened. What is the problem?

**A.** Until you open the oven door or touch the CLEAR/OFF pad, the oven remains in the preheat mode and no further instructions can be entered. After 30 minutes oven automatically turns off.

**Q.** Can I check during the cooking cycle to be sure that I have set the correct oven temperature?

**A. Yes.** If you touch the Convection COOK pad at any time during cooking, the selected oven temperature is displayed on the display.

**Q.** Can I store the probe in the oven when it is not in use?

**A.** Leaving the probe in the oven is not recommended. If you forget and leave it in during cooking, without having inserted it in food, damage to the probe or to the oven may result.

**Q.** May I cook two or more items at one time using the shelf?

**A. Yes.** During convection cooking the hot air circulates around each pan in all directions giving even browning to each food.

# COMBINATION TIME COOKING

Combination cooking offers the best features of microwave energy and convection cooking. **Microwaves cook food fast and convection circulation of heated air browns foods beautifully.**

Four combination cooking codes make it easy to set your oven for combination cooking. Just enter one digit to automatically set both oven temperature and microwave power level.

## How to Combination Time Cook

**Step 1:** Touch Combination COOK pad.

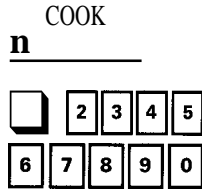

**Step 2:** Select a combination cooking code by touching a number pad from one to four.

**Step 3:** Enter desired cooking time in hours and minutes by touching number pads in sequence. For example for 1 hour and 20 minutes, touch 1, 2 and 0. To enter time less than one hour, for example, 30 minutes, touch 3 and 0.



**Step 4:** Touch START. Cooking time begins to count down. When time reaches less than 59 minutes, display shows minutes on left of colon and seconds on right. When time is completed, oven signals, flashes "End" and turns off.

## Questions and Answers

**Q. May I use my metal roasting pan to Combination Cook a roast?**

**A. No.** Do not use metal cookware on the metal wire shelf when using Microwave or Combination cooking. Place roast in glass dish on shelf.

**Q. Can I switch from one Combination code to another during cooking?**

**A. No.** The selected Combination code may not be changed during the cooking operation, but you may reprogram the complete cooking instructions if you wish.

**Q. Is it necessary to place a glass dish on the oven floor when Combination cooking?**

**A. No.** For best roasting results, place meat in a glass dish. Place dish on the oven shelf.

## Remember:

- Check the Cookware and Accessories section and your Cookbook for correct cookware when Combination cooking.
- For best roasting and browning results, whole roasts and poultry should be cooked in a dish placed directly on the oven shelf.
- Place meat in a glass dish on a trivet to collect juices and prevent spattering. See Convection preheat instructions in the Convection Time Cooking section.
- Some recipes call for preheating.

## Combination Codes

The guide on the right shows the oven temperature and microwave power (watts) that are automatically set when using that particular code number. You must set the cooking time or internal food temperature as shown above and in the Combination Temperature Cooking section. Check your Cookbook for specific food instructions.

Code	Oven Temp.	Microwave Power (Watts)
1	275° F.	220
2	300° F.	220
3	325° F.	220
<b>4</b>	<b>375° F.</b>	<b>220</b>



# COMBINATION TEMPERATURE COOKING

With this function of your new oven, you can enjoy the benefits of combination cooking with the precision of the temperature probe. Four combination codes are shown on the guide in the Combination Time Cooking section to make it easy to program microwave power level and oven temperature with only one entry. The probe makes it simple to cook to the exact degree of doneness desired, by monitoring the internal temperature of the food. This function is exactly like combination time cooking except you set internal food temperature desired instead of cooking time.

## How to Combination Temperature Cook

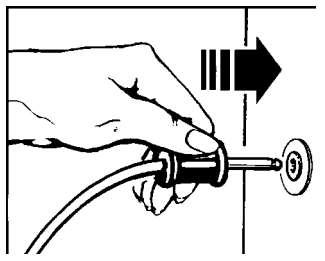

**Step 1:** Insert the temperature probe into food as directed in the Microwave Temperature Cooking section or in the Cookbook. Plug the other end securely into the oven wall receptacle.

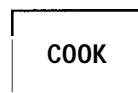

**Step 2:** Touch Combination COOK pad.



**Step 3:** Select the combination code by touching a number pad from 1 to 4 depending on oven temperature needed.



**Step 4:** Enter the desired finished food temperature by touching the number pads in sequence. For example, to set 180°F., touch 1, 8 and 0 in that order. The selected temperature is shown on the display.



**Step 5:** Touch START to begin cooking. The selected food temperature disappears and the display shows “-80” until internal food temperature reaches 80°F. Then display shows actual food temperature as it rises. When food reaches the selected temperature, the display shows “End” and the oven signals and turns off.

For information on cookware for combination temperature cooking, refer to the Cookware and Accessories section.

---

# COMBINATION AUTO ROAST

**Auto Roast is a combination function which is similar to combination temperature cooking, using both microwave and convection cooking in conjunction with the temperature probe. However, the Auto Roast feature eliminates most of the steps necessary to program combination temperature cooking. Instead, you can set the entire cooking program by selecting just one Auto Roast code.**

---

The food is placed in a glass dish on a trivet for cooking during Auto Roast. To select a code from 1 to 8 see Auto Roast Guide on this page.

## How to Combination Auto Roast

**Step 1:** Insert temperature probe into meat and plug the probe firmly into oven wall receptacle.

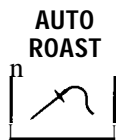

**Step 2:** Touch AUTO ROAST pad.

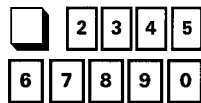

**Step 3:** Enter the desired Auto Roast cooking code by touching a number pad from 1 to 8.



**Step 4:** Touch START. Auto Roast Code number disappears. Display shows "ROAST FOOD TEMP" and "1 80" until food temperature reaches 80°F. Then display shows actual food temperature as it rises. When food reaches the programmed temperature for proper degree of doneness, the display shows "End" and the oven signals and turns off.

---

## Combination Auto Roast Guide (Use Probe)

Food	Temp.	Code
Beef, Rare	120°F.	1
Medium	130°F.	2
Well	160°F.	3
Lamb, Medium	40°F.	4
Well	60°F.	5
Pork	70°F.	6
Chicken	90°F.	7
Turkey	90°F.	8

---

## Questions and Answers

**Q. When I cook poultry, the thin, small areas like legs and wings often overcook before the rest of the bird is thoroughly cooked. How can I prevent this?**

**A.** Thin, uneven portions of poultry maybe shielded with aluminum foil during cooking. Do not allow foil to touch shelf or oven sides, arcing may occur.

**Q. Usually my temperature probe gives very accurate results, but this time it didn't. What happened?**

**A.** If the temperature probe is positioned touching fat or bone, an inaccurate reading may result. Be sure to place the probe in solid muscle, usually the thickest, meatiest part of the roast or poultry, or in the center of a meat loaf or casserole.

**Q. Meats often take longer than indicated in the guides to reach the desired internal temperature. Why?**

**A.** If the meat is recently defrosted and still very cold or icy inside, it will require a longer cooking time than meat which has been merely refrigerated. Times shown in the guides are usually for meats that are refrigerator temperature.

**Q. When I tried to program my oven for combination Auto Roast, it beeped and flashed "Prob." What did I do wrong?**

**A.** Auto Roast cannot be programmed without the temperature probe connected to the oven wall receptacle. To eliminate the "PROB" display and continue programming the oven, just securely insert the probe into the receptacle.

**Q. When I touched the START pad the display showed "180" instead of the food temperature. Why?**

**A.** If the temperature of the food is lower than 80°F. the display will indicate "180" until actual food temperature reaches 80°F. Then the display will show the internal food temperature as it continues to rise.

**Q. Do most meats require standing time after cooking with combination Auto Roast?**

**A.** You may want to let meats stand briefly, to allow easier carving and serving. Most meat roasts continue to cook for a few minutes after removing from the oven. Check the Cookbook for specific instructions.

# COOKING REFERENCE GUIDE

This is a Quick Reference to guide you in selecting the best method of cooking. Specific recipes can be adapted to any method of cooking.

\* — Best Method  
 A — Alternate  
 N — Not Recommended

Foods	Microwave	Combination	Convection
<b>Appetizers</b>			
Dips and Spreads	*	N	N
Pastry Snacks	A	*	A
<b>Beverages</b>	*	N	N
<b>Sauces and Toppings</b>	*	N	N
<b>Soups and Stews</b>	*	A	N
<b>Meats</b>			
Defrosting	*	N	N
Roasting	A	*	A
<b>Poultry</b>			
Defrosting	*	N	N
Roasting	A	*	A
<b>Fish and Seafood</b>			
Defrosting	*	N	N
Cooking	*	A	N
<b>Casseroles</b>	A	*	A
<b>Eggs and Cheese</b>			
Scrambled, Omelets	*	N	N
Quiche, Souffle	A	*	A
<b>Vegetables, Fresh</b>	*	N	N
<b>Breads</b>			
Quick	A	*	A
Yeast	N	A	*
<b>Muffins, Coffee Cake</b>	A	*	A
<b>Desserts</b>			
Cakes, Layer and Bundt	A	*	A
Angel Food and Chiffon	N	N	*
Custard and Pudding	*	N	N
Bar Cookies	A	*	A
Fruit	*	N	N
Pies and Pastry	N	A	*
Candy	*	N	N
<b>Blanching Vegetables</b>	*	N	N
<b>Frozen Convenience Foods</b>	*	A	A

## CONVECTION BROILING

For broiling time and procedures, refer to guide in Cookbook.

**Broiling is cooking food by intense heat from the upper unit in the oven. Most fish and tender cuts of meat can be broiled. Follow these steps to keep spattering and smoking to a minimum.**

**Step 1:** If meat has fat or gristle near edge, cut vertical slashes through both about 2 inches apart. If desired, fat maybe trimmed, leaving layer about 1/8 inch thick.

**Step 2:** Insert spatter shield onto drip pan. Always use spatter shield so fat drips into drip pan; otherwise juices may become hot enough to catch fire. You can use aluminum foil to line your drip pan and spatter shield. However, you must mold the foil tightly to the spatter shield and cut slits in it just like the spatter shield. Without the slits, the foil will prevent fat and meat juices from draining to the drip pan. The juices could become hot enough to catch on fire. If you do not cut the slits, you are frying, not broiling.



**Step 3:** Touch Convection BROIL pad.

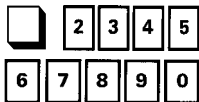

**Step 4:** Touch number pad 1 or 2 for desired Broil Code. Code 1 broils at 475°F. Code 2 broils at 450°F. Use Code 1 for thinner cuts of meat. "ENTER BROIL TIME" flashes on display but usually it is recommended that you preheat to preprogrammed broiling temperature. (See Step 5.)



**Step 5:** Touch START pad. "-200" shows on display until temperature reaches 200°F. Then display shows temperature rising in 5° increments.

**Step 6:** When preprogrammed temperature is reached, oven signals and "ENTER BROIL TIME" flashes on display. Place food on broiler pan assembly.

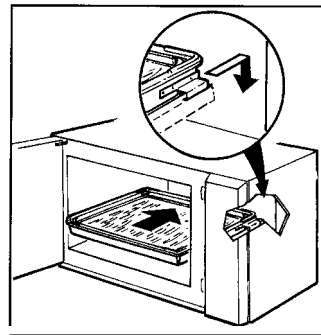

**Step 7:** Open the door and insert broiler pan with stop-locks resting on guides on side walls of oven and push toward rear of oven until it falls into correct position under guides. "Hot" appears on display when door is opened.

**To remove,** lift up rear of pan and pull forward with stop-locks along top edge of oven guides. Keep the pan level during removal.

**NOTE:** If oven door remains closed, oven will hold preprogrammed temperature for 30 minutes and then shut off.

**Step 8:** Enter broiling time by touching number pads in sequence. For 25 minutes, touch 2, 5, 0 and O.



**Step 9:** Touch START pad.

**Step 10:** When broiling is completed, oven signals and flashes "End." Oven, light and fan shut off.

## Questions and Answers

**Q. May I use aluminum foil to line the drip pan and spatter shield?**

**A. Yes,** if you mold the foil thoroughly to the spatter shield and slit it to conform to the slots in the shield. Slots permit proper drainage of meat juices into drip pan, minimizing smoking and spattering and preventing possibility of fire from overheated drippings.

**Q. When broiling, is it necessary to always use the spatter shield in the pan?**

**A. Yes.** Using the spatter shield suspends the meat over the pan. As the meat cooks, the juices fall into the pan, thus keeping meat drier. Juices are protected by the shield and stay cooler, thus preventing excessive spatter and smoking.

**Q. Should I salt the meat before broiling?**

**A. No.** Salt draws out the juices and allows them to evaporate. Always salt after cooking. Turn meat with tongs; piercing meat with a fork also allows juices to escape. When broiling poultry or fish, brush each side often with butter.

**Q. Why are my meats not turning out as brown as they should?**

**A.** In some areas, the power (voltage) to the oven maybe low. In these cases, preheat the broil unit for 10 minutes before placing broiler pan assembly with food in oven. Turn food only once during broiling.

**Q. Do I need to grease my broiler spatter shield to prevent meat from sticking?**

**A.** The spatter shield is designed to reflect broiler heat, thus keeping the surface cool enough to prevent meat sticking to the surface. However, spraying the shield lightly before cooking with a vegetable cooking spray will make cleanup easier.

# CARE AND CLEANING

## Follow these simple care rules:

- Keep inside of oven clean. Food spatters or spilled liquids will absorb microwave energy and reduce efficiency of oven. Wipe up when they are still warm.
- A browning dish is designed only for use on the Microwave setting. When microwaving, preheat browning dish or grill only on ceramic oven floor. Do not use dish with oven shelf.
- Always follow manufacturer's suggestions when using browning dish or accessories.
- Follow manufacturer's instructions when using microwave cookware or accessories.

## CLEANING GUIDE

**NOTE: Let oven parts cool before touching or handling.**

PART	MATERIALS TO USE	GENERAL DIRECTIONS
<b>Stainless Steel Oven Interior</b> –Side Walls Only –Ceiling	<ul style="list-style-type: none"> <li>• Damp Cloth</li> <li>• Plastic Scouring Ball</li> <li>• Non-abrasive Scouring Powder (brush-on type)</li> </ul>	Clean with mild detergent and water, then rinse well with damp cloth. If desired, a container of water can be boiled in the oven using microwave energy. This will help loosen soil. For hard-to-remove soil, clean gently with scouring ball. Do not use abrasive cleaners which could scratch or damage the surface. For excessive soil, use a chemical cleaner, preferably the brush-on type. Use on stainless steel parts <b>only</b> .
<b>Ceramic Oven Floor</b>	<ul style="list-style-type: none"> <li>• Non-abrasive Nylon Mesh Scouring Ball</li> <li>• Non-abrasive Cleanser</li> </ul>	Wash floor with warm sudsy water.
<b>Metal Shelf Accessory</b>	<ul style="list-style-type: none"> <li>• Soap and Water</li> <li>• Soap-Filled Scouring Pad</li> <li>• Commercial Oven Cleaner</li> </ul>	Remove shelf and clean with one of the recommended materials. Then rinse and dry thoroughly. Some commercial cleaners may cause darkening or discoloration. When using for the first time, test cleaner on small portion of the shelf.
<b>Broiler Pan (spatter shield and drip pan)</b>	<ul style="list-style-type: none"> <li>• Soap and Water</li> <li>• Soap-Filled Scouring Pad</li> <li>• Commercial Oven Cleaner</li> </ul>	After broiling, remove the broiler pan from the oven. Remove the spatter shield from the drip pan. Carefully pour out the grease in the drip pan into a proper container. Wash; scour if necessary with a soap-filled or plastic scouring pad, in hot, soapy water. Rinse the drip pan and spatter shield in hot water. If food has burned on, sprinkle the spatter shield while hot with detergent and cover with wet paper towels or a dish cloth. That way, burned-on foods will soak loose while the meal is being served. <b>OPTION: The drip pan and spatter shield may also be cleaned in a dishwasher.</b>
<b>Inside Oven Door and Window</b>	<ul style="list-style-type: none"> <li>• Soft Cloth</li> <li>• Mild Detergent</li> </ul>	Wipe off spills or spatters while they are still warm. Use mild detergent and water, then rinse with clear water and dry with a soft cloth.
<b>Outside Oven Surfaces</b>	<ul style="list-style-type: none"> <li>• Mild Detergent</li> <li>• Soft Cloth</li> </ul>	Clean with mild detergent and water, rinse and dry with a soft cloth. Clean chrome trim with a damp cloth and polish immediately with a dry cloth.
<b>Touch Control Panel</b>	<ul style="list-style-type: none"> <li>• Soft Cloth</li> </ul>	Open oven door before cleaning to prevent oven from accidentally starting. Wipe with a damp cloth followed immediately by a dry cloth.
<b>Temperature Probe</b>	<ul style="list-style-type: none"> <li>• Plastic Scouring Ball</li> </ul>	Clean as soon after using as possible. To clean, wipe with sudsy cloth, then rub lightly with scouring ball if necessary. Rinse and dry. <b>Do not immerse the temperature probe in water. Do not store the temperature probe in the oven.</b>

**NOTE:** If steam accumulates inside or around outside of oven door, wipe with soft cloth. This may occur when operating the oven under high humidity conditions.

# GROUNDING INSTRUCTIONS

This appliance must be grounded. In the event of an electrical short circuit, grounding reduces the risk of electric shock by providing an escape wire for the electric current. This appliance is equipped with a power cord having a grounding wire with a grounding plug. The plug must be plugged into an outlet that is properly installed and grounded. (Fig. 1)

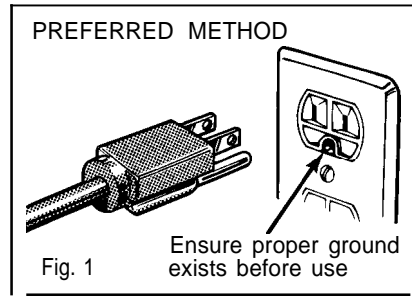

**WARNING** – Improper use of the grounding plug can result in a risk of electric shock.

Consult a qualified electrician or service technician if the grounding instructions are not completely understood, or if doubt exists as to whether the appliance is properly grounded.

Where a standard two-prong wall receptacle is encountered, it is your personal responsibility and obligation to have it replaced with a properly grounded three-prong wall receptacle.

Do not under any circumstances cut or remove the third (ground) prong from the power cord.

## Use of Adapter Plugs

### Usage situations where appliance's power cord will be disconnected infrequently.

Because of potential safety hazards under certain conditions, we strongly recommend against the use of an adapter plug. However, if you still elect to use an adapter, where local codes permit, a **TEMPORARY CONNECTION** may be made to a properly grounded two-prong wall receptacle by the use of a UL listed adapter (Fig. 2) which is available at most local hardware stores.

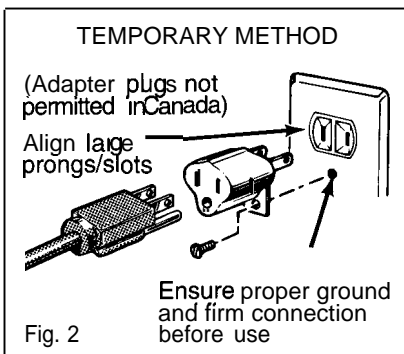

The larger slot in the adapter must be aligned with the larger slot in the wall receptacle to provide proper polarity in the connection of the power cord.

**Caution:** Attaching the adapter ground terminal to the wall receptacle cover screw does not ground the appliance unless the cover screw is metal, and not insulated, and the wall receptacle is grounded through the house wiring. You should have the circuit checked by a qualified electrician to make sure the receptacle is properly grounded.

When disconnecting the power cord from the adapter, always hold the adapter with one hand. If this is not done, the adapter ground terminal is very likely to break with repeated use. Should this happen, **DO NOT USE** the appliance until a proper ground has again been established.

### Usage situations where appliance's power cord will be disconnected frequently.

**Do not use an adapter plug** in these situations because frequent disconnection of the power cord places undue strain on the adapter and leads to eventual failure of the adapter ground terminal. You should have the two-prong wall receptacle replaced with a three-prong (grounding) receptacle by a qualified electrician before using the appliance.

*(continued next page)*

---

# GROUNDING INSTRUCTIONS

(continued)

## Use of Extension Cords

A short power-supply cord is provided to reduce the risks resulting from becoming entangled in or tripping over a longer cord.

Longer cord sets or extension cords are available and may be used if care is exercised in their use.

If a long cord or extension cord is used—

1. The marked electrical rating of the cord set or extension cord should be at least as great as the electrical rating of the appliance;
2. The extension cord must be a grounding-type 3-wire cord;
3. The longer cord should be arranged so that it will not drape over the counter top or tabletop where it can be pulled on by children or tripped over unintentionally.

If you use an extension cord, the interior light may flicker and the blower sound may vary when the microwave oven is on. Cooking times maybe longer, too.

---

## OVEN LAMP REPLACEMENT

**If oven light burns out, you may replace it by carefully following the directions below:**

**Step 1:** Disconnect oven power cord from electrical outlet.

**Step 2:** Unscrew and remove oven light bulb cover located on left side of cabinet. Do not remove any other part of cabinet.

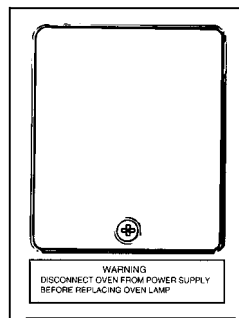

**Step 3:** Let bulb cool before removing. Gently twist the bulb to break the silicone adhesive attached to the bulb and socket to prevent damage during shipping. Turn bulb counterclockwise to remove from socket.

**Step 4:** Replace bulb with a special 20 watt light bulb. Insert bulb into socket and turn in clockwise direction.

**Step 5:** Replace light bulb cover.

**Step 6:** Plug oven power cord into electrical outlet. Reset oven clock.



# QUESTIONS? USE THIS PROBLEM SOLVER

PROBLEM	POSSIBLE CAUSE
OVEN WILL NOT COME ON	<ul style="list-style-type: none"> <li>• A fuse in your home may be blown or the circuit breaker tripped. Replace fuse or reset circuit breaker.</li> <li>• Unplug your microwave/convection oven, then plug it back in.</li> <li>• Make sure 3-prong plug on oven is fully inserted into wall receptacle.</li> </ul>
CONTROL PANEL LIGHTED, YET OVEN WILL NOT START	<ul style="list-style-type: none"> <li>• Door not securely closed.</li> <li>• START pad must be touched after entering cooking selection.</li> <li>• Another selection entered already in oven and CLEAR/OFF pad not touched to cancel it.</li> <li>• Make sure you have entered cooking time or temperature after touching COOK pads.</li> <li>• CLEAR/OFF pad was touched accidentally. Reset cooking program and touch START pad.</li> <li>• Temperature probe not inserted properly during Temperature Cook function or not being used during Auto Roast.</li> <li>• Make sure you have entered a desired finished temperature after setting Temperature Cook programs.</li> <li>• Make sure you have entered a code number after touching AUTO COOK, AUTO ROAST or-AUTO DEFROST pads.</li> <li>• Make sure you have entered a code number after touching Combination COOK pad for Combination Time Cooking or Combination Temperature Cooking.</li> </ul>
FOODS ARE EITHER OVERCOOKED OR UNDERCOOKED	<ul style="list-style-type: none"> <li>• Not enough time set when using Time Cook function because starting food temperatures vary.</li> <li>• The density and amount of foods will vary and thus may need more time for completion.</li> <li>• Dish in Auto Cook not covered as directed.</li> <li>• Check Cookbook and Microwave Temperature Cooking section for specific probe placement.</li> <li>• Incorrect code numbers entered after touching AUTO COOK or AUTO ROAST pads.</li> <li>• Incorrect power level entered.</li> <li>• Dish not rotated, turned or stirred if these instructions were given in the recipe.</li> <li>• Too many dishes in oven at same time,</li> <li>• Check Cookbook for correct accessories such as shelves and food placement on them.</li> <li>• Incorrect finished temperature entered with temperature-controlled functions.</li> <li>• Flow of air blocked with convection or combination cooking functions.</li> </ul>
“FFFF” APPEARS ON DISPLAY	<ul style="list-style-type: none"> <li>• Indicates open or short circuit in any one of a number of components. Power is shut off automatically. Request service.</li> </ul>
“EEEE” APPEARS ON DISPLAY	<ul style="list-style-type: none"> <li>• Impossible time of day such as 13:00 has been entered for clock.</li> </ul>
“PROB” APPEARS ON DISPLAY	<ul style="list-style-type: none"> <li>• Temperature probe not plugged in securely when using Temperature Cook Auto Roast.</li> </ul>

**If you need more help...call, toll free:  
GE Answer Center™  
800.626.2000  
consumer information service**

With the purchase of your new Monogram appliance, receive the assurance that if you ever need information or assistance from GE, we'll be there. All you have to do is call—toll-free!

## ***In-Home Repair Service*** **800.GE.CARES (800.432.2737)**

AGE consumer service professional will provide expert repair service, scheduled at a time that's convenient for you. Many GE Consumer Service company-operated locations offer you service today or tomorrow, or at your convenience (7:00 a.m. to 7:00 p.m. weekdays, 9:00 a.m. to 2:00 p.m. Saturdays). Our factory-trained technicians know your appliance inside and out—so most repairs can be handled in just one visit.

## ***GE Answer Center®*** **800.626.2000**

Whatever your question about any Monogram major appliance, GE Answer Center® information service is available to help. Your call—and your question—will be answered promptly and courteously. And you can call any time. GE Answer Center® service is open 24 hours a day, 7 days a week.

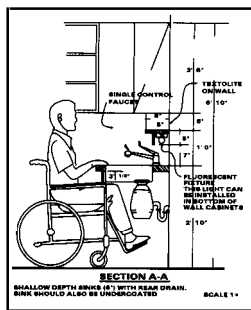

## ***For Customers With Special Needs...*** **800.626.2000**

Upon request, GE will provide Braille controls for a variety of Monogram appliances, and a brochure to assist in planning a barrier-free kitchen for persons with limited mobility. To obtain these items, free of charge, call 800.626.2000.

Consumers with impaired hearing or speech who have access to a TDD or a conventional teletypewriter may call 800-TDD-GEAC (800-8334322) to request information or service.

## ***Service Contracts*** **8086262224**

You can have the secure feeling that GE Consumer Service will still be there after your warranty expires. Purchase a GE contract while your warranty is still in effect and you'll receive a substantial discount. With a multiple-year contract, you're assured of future service at today's prices.

## ***Parts and Accessories*** **8006262002**

Individuals qualified to service their own appliances can have needed parts or accessories sent directly to their home. The GE parts system provides access to over 47,000 parts... and all GE Genuine Renewal Parts are fully warranted. VISA, MasterCard and Discover cards are accepted.

User maintenance instructions contained in this booklet cover procedures intended to be performed by any user. Other servicing generally should be referred to qualified service personnel. Caution must be exercised, since improper servicing may cause unsafe operation.

# YOUR GE MICROWAVE/CONVECTION OVEN WARRANTY

Save proof of original purchase date such as your sales slip or cancelled check to establish warranty period.

## WHAT IS COVERED

### FULL ONE-YEAR WARRANTY

For one year from date of original purchase, we will provide, free of charge, parts and service labor in your home to repair or replace **any part of the microwave/convection oven** that fails because of a manufacturing defect.

### LIMITED ADDITIONAL FOUR-YEAR WARRANTY

For the second through fifth year from date of original purchase, we will provide, free of charge, a replacement **magnetron tube** if the magnetron tube fails because of a manufacturing defect. You pay for the service trip to your home and service labor charges.

This warranty is extended to the original purchaser and any succeeding owner for products purchased for **ordinary** home use in the 48 mainland states, Hawaii and Washington, D.C. In Alaska the warranty is the same except that it is LIMITED because you must pay to ship the product to the **service** shop or for the **service** technician's travel costs to your home.

All warranty service will be provided by our **Factory Service Centers** or by our authorized Customer **Care**<sup>®</sup> servicers during normal working hours.

Should your appliance need service, during warranty period or beyond, call 800-GE CARES (800-432-2737).

## WHAT IS NOT COVERED

- Service trips to your home to teach you how to use the product.

### Read your Use and Care material.

If you then have any questions about operating the product, please contact your dealer or our Consumer Affairs office at the address below, or call, toll free:

GE Answer Center<sup>™</sup>  
800.626.2000  
consumer information service

- Improper installation.

If you have an installation problem, contact your dealer or installer. You are responsible for providing adequate electrical, gas, exhausting and other connecting facilities.

- Replacement of house fuses or resetting of circuit breakers.
- Failure of the product if it is used for other than its intended purpose or used commercially.
- Damage to product caused by accident, fire, floods or acts of God.

WARRANTOR IS **NOT RESPONSIBLE** FOR CONSEQUENTIAL DAMAGES.

Some states do not allow the exclusion or limitation of incidental or consequential damages, so the above limitation or exclusion may not apply to you. This warranty gives you specific legal rights, and you may also have other rights which vary from state to state. To know what your legal rights are in your state, consult your local or state consumer affairs office or your state's Attorney General.

**Warrantor: General Electric Company**

**If further help is needed concerning this warranty, write:  
Manager—Consumer Affairs, GE Appliances, Louisville, KY 40225**

JET343G



*Monogram™*

---

General Electric Company  
Louisville, KY 40225

Pub.No. 49-8332  
Part No. 164 D2588P132  
& 92 CG

## Free Manuals Download Website

<http://myh66.com>

<http://usermanuals.us>

<http://www.somanuals.com>

<http://www.4manuals.cc>

<http://www.manual-lib.com>

<http://www.404manual.com>

<http://www.luxmanual.com>

<http://aubethermostatmanual.com>

Golf course search by state

<http://golfingnear.com>

Email search by domain

<http://emailbydomain.com>

Auto manuals search

<http://auto.somanuals.com>

TV manuals search

<http://tv.somanuals.com>