

Monogram®

Use and Care Guide

for Side-by-Side
36", 42", 48"
Built-In
Refrigerators

Introduction

Your new Monogram refrigerator makes an eloquent statement of style, convenience and kitchen planning flexibility. Whether you chose it for its purity of design, practical storage arrangements or assiduous attention to detail—or for all of these reasons—you'll find that your Monogram refrigerator's superior blend of form and function will delight you for years to come.

The Monogram refrigerator was designed to provide the flexibility to blend in with your kitchen cabinetry. Decorative door insert panels allow it to match your kitchen cabinets or blend with your kitchen decor. Custom handles are also available to further personalize your refrigerator. Through a series of product and trim kit choices, the Monogram refrigerator can be beautifully integrated into the kitchen.

Since this is designed to be a built-in product, custom panels are required on the front of the Monogram refrigerator. Consult your kitchen designer or cabinetmaker for your customized look.

The information on the following pages will help you operate and maintain your refrigerator properly.

If you have any questions, call the GE Answer Center® 800.626.2000.

In Canada, please call 1.888.880.3030.

Contents

Consumer Services

Important Phone Numbers	24
Model and Serial Numbers	3
Problem Solver	21–23
Product Registration	3, 26
Safety Instructions	4–7
Warranty for customers in Canada	27
Warranty for customers in the USA	Back Cover

Care and Cleaning

Cleaning—Outside and Inside	17
Cleaning—Condensator Fins	18
Light Bulb Replacement	19
Moving and Vacation	18

Operating Instructions

Automatic Icemaker	10
Shelves	15, 16
Storage Drawers	13, 14
Temperature Controls	8, 9

Preparation

Clearances	20
Location	20
Rollers	20

Before using your refrigerator

Read this guide carefully. It is intended to help you operate and maintain your new refrigerator properly.

Keep it handy for answers to your questions.

If you don't understand something or need more help, call:

**GE Answer Center®
800.626.2000**

24 hours a day, 7 days a week

In Canada, call 1.888.880.3030.

*Write
down the
model &
serial
numbers*

You'll see them on a label above the freezer compartment behind the top panel.

These numbers are also on the Consumer Product Ownership Registration Card included with this guide.

Before sending in this card, please write these numbers here:

Model Number

Serial Number

Use these numbers in any correspondence or service calls concerning your refrigerator.

*If you
received a
damaged
refrigerator*

Immediately contact the dealer (or builder) that sold you the refrigerator.

*Save time
& money*

Before you request service, check the Problem Solver in the back of this guide.

It lists causes of minor operating problems that you can correct yourself.

*If you
need
service*

To obtain service, see the Consumer Services page in the back of this guide.

We're proud of our service and want you to be pleased. If for some reason you are not happy with the service you receive, here are steps to follow for further help.

FIRST, contact the people who serviced your appliance. Explain why you are not pleased. In most cases, this will solve the problem.

NEXT, if you are still not pleased, write all the details—including your phone number—to:

Manager, Consumer Relations
GE Appliances
Appliance Park
Louisville, KY 40225

For customers in Canada :

FIRST, contact the people who serviced your appliance. Explain why you are not pleased. In most cases, this will solve the problem.

NEXT, if you are still not pleased, write all the details—including your phone number to:

Manager, Consumer Relations
Camco Inc.
1 Factory Lane, Suite 310
Moncton, N.B. E1C 9M3

IMPORTANT SAFETY INSTRUCTIONS

READ AND SAVE THESE INSTRUCTIONS

- ▲ WARNING**—When using this appliance, always exercise basic safety precautions, including the following:
- **Use this appliance only for its intended purpose** as described in this Use and Care Guide.
 - **This refrigerator must be properly installed in accordance with the Installation Instructions before it is used.**
 - **Do not allow children to climb, stand or hang on the shelves in the refrigerator.** They could damage the refrigerator and seriously injure themselves.
 - **After your refrigerator is in operation, do not touch the cold surfaces in the freezer compartment, particularly when hands are damp or wet.** Skin may adhere to these extremely cold surfaces.
 - **Do not store or use gasoline or other flammable vapors and liquids in the vicinity of this or any other appliance.**
 - **If your refrigerator has an automatic icemaker,** avoid contact with the moving parts of the ejector mechanism, or with the heating element that releases the cubes. Do not place fingers or hands on the automatic icemaking mechanism while the refrigerator is plugged in.
 - **Unplug your refrigerator before cleaning and making repairs.** **NOTE:** We strongly recommend that any servicing be performed by a qualified individual.
 - **Before replacing a burned-out light bulb,** the refrigerator should be unplugged in order to avoid contact with a live wire filament. (A burned-out light bulb may break when being replaced.) **NOTE:** Turning control to “0” does not remove power to the light circuit.
 - **Do not refreeze frozen foods which have thawed completely.**

▲ DANGER: RISK OF CHILD ENTRAPMENT

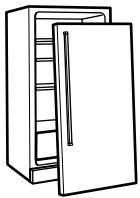

Child entrapment and suffocation are not problems of the past. Junked or abandoned refrigeration products are still dangerous. . . even if they will sit for “just a few days.” If you are getting rid of your old appliance, please follow these instructions to help prevent accidents.

Before You Throw Away Your Old Refrigeration Product:

- Take off the doors.
- Leave the shelves in place so that children may not easily climb inside.

CFC DISPOSAL

Old refrigeration products have cooling systems that used CFCs (chlorofluorocarbons). CFCs are believed to harm stratospheric ozone.

If you are throwing away an old refrigeration product, make sure the CFC refrigerant is removed for proper disposal by a qualified servicer. If you intentionally release this CFC refrigerant you can be subject to fines and imprisonment under provisions of environmental legislation.

IMPORTANTES INSTRUCTIONS DE SÉCURITÉ

LIRE ET CONSERVER CES INSTRUCTIONS

▲ AVERTISSEMENT : Lorsque vous utilisez le réfrigérateur, observez toujours certaines précautions de base, notamment:

- **N'utilisez le réfrigérateur que pour son usage prévu**, comme décrit dans le présent guide.
- **Installez le réfrigérateur conformément aux directives d'installation avant de l'utiliser.**
- **Ne laissez pas les enfants grimper, s'asseoir, se tenir debout ni se pendre aux clayettes du réfrigérateur.** Ils pourraient endommager le réfrigérateur et se blesser gravement.
- **Une fois le réfrigérateur en marche, ne touchez pas les surfaces froides du congélateur, surtout si vous avez les mains humides ou mouillées :** la peau risque d'adhérer à ces surfaces très froides.
- **N'entreposez et n'utilisez pas d'essence ou autres vapeurs et liquides inflammables à proximité de cet appareil ou de tout autre appareil électroménager.**

- **Si votre réfrigérateur est doté d'une machine à glaçons automatique**, évitez le contact avec les pièces mobiles du mécanisme éjecteur, ou avec l'élément chauffant qui libère les glaçons. Ne posez pas les doigts ou les mains sur le mécanisme de la machine à glaçons pendant que le réfrigérateur est branché.

- **Débranchez votre réfrigérateur avant de le nettoyer et de le réparer.**

REMARQUE : Nous vous recommandons vivement de confier toute réparation à un technicien qualifié.

- **Avant de remplacer une ampoule grillée**, le réfrigérateur doit être débranché afin d'éviter tout contact avec un fil sous tension. (Une ampoule grillée peut se briser pendant l'opération).

REMARQUE : Lorsque vous placez la commande sur «0» (éteint), l'alimentation électrique de l'ampoule n'est pas coupée.

- **Ne faites PAS recongeler des aliments surgelés qui ont complètement dégelé.**

▲ DANGER! RISQUES POUR LES ENFANTS

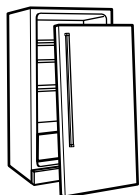

Les enfants pris au piège ou morts d'asphyxie sont toujours d'actualité. Les appareils de réfrigération abandonnés sont toujours aussi dangereux, même si on n'attend que "quelque jours" pour s'en débarrasser. Si vous ne gardez pas votre ancien appareil, veuillez suivre les directives ci-dessous afin de prévenir les accidents.

Avant de vous débarrasser de votre vieux appareil de réfrigération:

- Démontez les portes.
- Laissez les clayettes en place afin d'empêcher les enfants de grimper à l'intérieur.

SE DÉBARRASSER DU CFC

Les vieux appareils de réfrigération ont un système de refroidissement qui a utilisé les CFC (chlorofluorocarbones). Les CFCs sont jugés nocifs pour l'ozone stratosphérique.

Si vous débarrassez de votre vieil appareil de réfrigération, assurez-vous que le frigorigène

avec CFC soit enlevé correctement par un technicien qualifié. Si vous libérez intentionnellement ce frigorigène avec CFC vous pouvez être soumis aux contraventions et à l'emprisonnement après les stipulations des lois sur l'environnement.

IMPORTANT SAFETY INSTRUCTIONS

HOW TO CONNECT ELECTRICITY

Do not, under any circumstances, cut or remove the third (ground) prong from the power cord. For personal safety, this appliance must be properly grounded.

The power cord of this appliance is equipped with a 3-prong (grounding) plug which mates with a standard 3-prong (grounding) wall outlet to minimize the possibility of electric shock hazard from this appliance.

Have the wall outlet and circuit checked by a qualified electrician to make sure the outlet is properly grounded.

Where a standard 2-prong wall outlet is encountered, it is your personal responsibility and obligation to have it replaced with a properly grounded 3-prong wall outlet.

**DO NOT USE AN ADAPTER PLUG TO CONNECT THE REFRIGERATOR TO A 2-PRONG OUTLET.
DO NOT USE AN EXTENSION CORD WITH THIS APPLIANCE.**

The appliance should always be plugged into its own individual electrical outlet which has a voltage rating that matches the rating plate. This provides the best performance and also prevents overloading house wiring circuits which could cause a fire hazard from overheated wires.

Never unplug an appliance by pulling on the power cord. Always grip the plug firmly and pull straight out from the outlet.

Repair or replace immediately all power cords that have become frayed or otherwise damaged. Do not use a cord that shows cracks or abrasion damage along its length or at either end.

When moving the appliance, be careful not to roll over or damage the power cord.

SAVE THESE INSTRUCTIONS

IMPORTANTES INSTRUCTIONS DE SÉCURITÉ

RACCORDEMENT ÉLECTRIQUE

Ne coupez ni retirez en aucun cas la troisième broche (mise à la terre) de la fiche du cordon d'alimentation. Pour votre sécurité, cet appareil doit être correctement mis à la terre.

Le cordon d'alimentation de cet appareil est muni d'une fiche à 3 broches (mise à la terre) qui se branche dans une prise mural ordinaire à 3 alvéoles (mise à la terre) pour réduire au minimum les risques du chocs électriques.

Faites examiner la prise de courant et le circuit par un électricien qualifié pour vous assurer que la prise est correctement mise à la terre.

Si la prise murale est du type standard à 2 alvéoles, il vous incombe de la faire remplacer par une prise à 3 alvéoles correctement mise à la terre.

La machine à glaçons doit toujours être branché dans sa propre prise de courant, dont la tension nominale est identique à celle indiquée sur la plaque signalétique.

N'UTILISEZ PAS UNE FICHE D'ADAPTATION POUR RACCORDER LE RÉFRIGÉRATEUR DANS UNE PRISE MURALE À 2 ALVÉOLES. N'UTILISEZ PAS DE CORDONS PROLONGATEURS AVEC CET APPAREIL.

Cette précaution est recommandée pour garantir un rendement optimum et éviter une surcharge des circuits électriques de la résidence, ce qui pourrait créer un risque d'incendie par surschauffe des fils. Ne débranchez jamais l'appareil en tirant le cordon d'alimentation. Saisissez fermement la fiche du cordon et tirez droit pour la retirer de la prise.

Réparez ou remplacez immédiatement tout cordon effiloché ou endommagé. N'utilisez pas un cordon fendillé ou présentant des signes d'usure.

Lorsque vous déplacez l'appareil du mur, faites attention de ne pas la faire rouler sur le cordon d'alimentation afin de ne pas l'endommager.

CONSERVEZ CES DIRECTIVES

Operating Instructions

Built - In Refrigerators

Set Temperature Controls (appearance may vary)

Your refrigerator has two controls that let you regulate the temperature in the fresh food and freezer compartments.

They have settings from 1 through 9, and are located at the top of the fresh food compartment.

The freezer control also has an OFF setting.

9 is the coldest setting, 1 is the warmest.

WHEN YOU FIRST TURN THE REFRIGERATOR ON, SET BOTH CONTROLS AT 5.

For colder or warmer temperatures, adjust the desired compartment control 1 number at a time.

IMPORTANT: When first setting controls, or adjusting them, allow 24 hours for the refrigerator to get cold.

Note: Turning the freezer control to the OFF position stops cooling in BOTH compartments—fresh food AND freezer—but does not shut off power to the refrigerator.

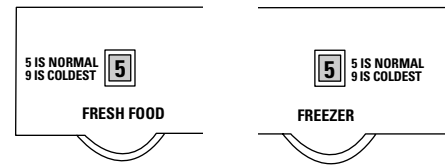

How to test temperatures

Use the milk test for the fresh food compartment. Place a container of milk on the top shelf in the fresh food compartment. Check it a day later. If the milk is too warm or too cold, adjust the temperature controls.

Use the ice cream test for the freezer compartment. Place a container of ice cream in the center of the freezer compartment. Check it after a day. If it's too hard or too soft, adjust the temperature controls.

Always allow 24 hours for the refrigerator to reach the temperature you set.

Energy saver switch

The energy saver switch is located on the temperature control panel.

To reduce the amount of electricity required to operate your refrigerator, push switch to ENERGY SAVER setting.

This turns off the heater in your refrigerator that prevents moisture from forming on the outside of the refrigerator.

With the heater turned off, there is a chance that moisture may form on the outside of your refrigerator, especially when the weather is humid.

The humidity is most likely to be high in the summer, in the early morning hours, and in homes which are not air conditioned.

Over an extended period of time, moisture that forms on the refrigerator surface may cause deterioration of the paint finish. It will be important to protect the finish by using appliance polish wax as described in the Care and Cleaning section.

Move the energy saver switch from the ENERGY SAVER setting and electricity flows through the low wattage heater which warms the outside of the refrigerator. Under most conditions, this prevents the forming of moisture or water droplets.

No defrosting

It is not necessary to defrost the freezer or fresh food compartments. Although your refrigerator is designed and equipped to defrost itself automatically, some frost on packages is normal.

Automatic icemaker (on some models)

A newly-installed refrigerator may take 8 to 12 hours to begin making ice.

The icemaker will produce eight cubes per cycle—approximately 100 cubes in a 24-hour period, depending on freezer compartment temperature, room temperature, number of door openings and other use conditions.

If your refrigerator is operated before the water connection is made to the icemaker, keep the feeler arm in the STOP (up) position.

When the refrigerator has been connected to the water supply, move the feeler arm to the ON (down) position.

The ice maker will fill with water when it cools to freezing. A newly-installed refrigerator may take 8 to 12 hours to begin making ice cubes.

Throw away the first few batches of ice. This flushes away impurities in the water line.

Icemaking will continue until the feeler arm senses enough ice cubes in the storage bin. For maximum ice production, level the stored cubes with your hand occasionally. Be sure nothing interferes with the swing of the feeler arm.

The icemaker ejects cubes in groups of eight and it is normal for several cubes to be joined together.

Move the icemaker feeler arm to the STOP (up) position when:

- home water supply is to be off for several hours.
- ice storage bin is to be removed for a period of time.

- going away on vacation, at which time you should also turn off the valve in the water supply line to your refrigerator.
- turning the freezer control to the OFF position.

If ice is not used frequently, old ice cubes will become cloudy and taste stale. Empty the ice storage bin periodically and wash it in lukewarm water. Be sure to allow the storage bin to dry before replacing it—otherwise ice cubes may stick to other parts of the icemaker.

If this is your first icemaker, you'll hear occasional sounds that may be unfamiliar. They are normal icemaking sounds and are not a cause for concern.

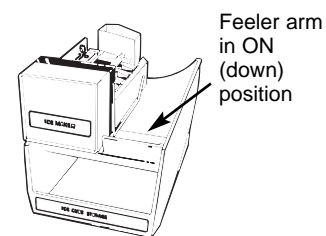
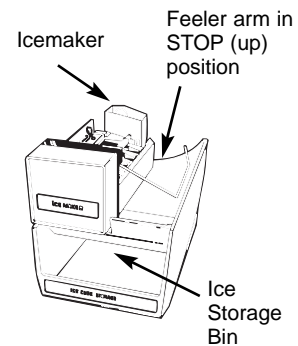

Ice & Water Dispenser (on some models)

Built - In Refrigerators

To use the dispenser

Select CUBES, CRUSHED ICE (on some models) or WATER.

Press the rim of the glass gently against the dispenser pad.

The spill shelf is not self-draining. To reduce water spotting, the shelf and its grille should be cleaned regularly.

If no water is dispensed when the refrigerator is first installed, there may be air in the water line system. Press the dispenser pad for at least two minutes to remove trapped air from the water line and to fill the water system. To flush out impurities in the water line, throw away the first six glassfuls of water.

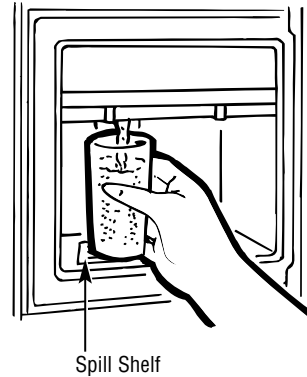

Ice storage bin

To remove:

Lift the left corner to free the bin from the shelf and pull the bin straight out while supporting it at front and rear.

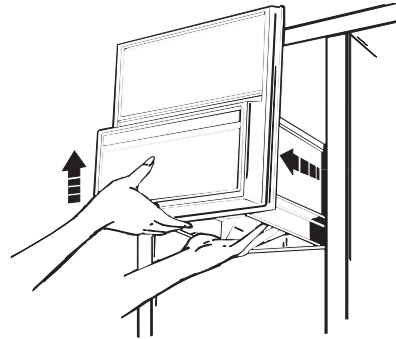

To replace:

Slide the bin back until the tab on the bin locks into the slot on the shelf. If the bin does not go all the way back, remove it and rotate the drive mechanism 1/4 turn. Then push the bin back again.

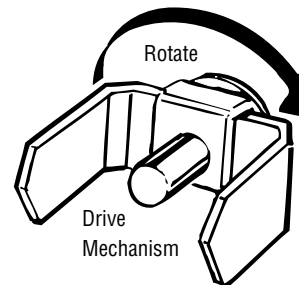

CAUTION: Never put fingers or any other objects into the ice crusher discharge opening.

Important facts about your ice & water dispenser

- Add ice before filling the glass with a beverage. This will prevent splashing, which could cause the ice selector switch to stick or bind.
- Do not add ice from trays or bags to the storage bin. It may not crush or dispense well.
- Avoid overfilling glass with ice and use of narrow or extra-tall glasses. Backed-up ice can jam the chute or cause the door in the chute to freeze shut. If ice is blocking the chute, poke it through with a wooden spoon.
- Beverages and foods should not be quick-chilled in the ice storage bin. Cans, bottles or food packages in the storage bin may cause the icemaker or auger to jam.
- Some crushed ice may be dispensed even though you selected CUBES. This happens occasionally when a few cubes accidentally get directed to the crusher.
- After crushed ice is dispensed, some water may drip from the chute.
- Sometimes a mound of snow will form on the door in the ice chute. This condition is normal and usually occurs when you have dispensed crushed ice repeatedly. The snow will eventually evaporate.
- Dispensed water is not ice cold. For colder water, simply add crushed ice or cubes before dispensing water.
- The first glass of water dispensed may be warmer than the following ones. This is normal.

Storage Drawers

Built - In Refrigerators

Storage drawers

Excess water that may accumulate in the bottom of the drawers should be emptied and the drawers wiped dry.

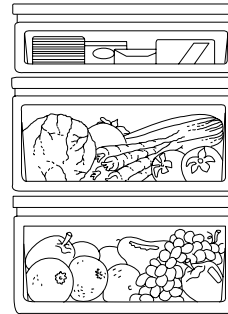

Fruit and vegetable drawers

The storage drawers at the bottom of the fresh food compartment are designed to provide high humidity levels required by most vegetables and lower humidity levels required for most fruits.

When replacing the drawers, always push them all the way in.

Storage time will depend upon the type of food and its condition when placed in the drawers.

High humidity setting

This refrigerated drawer is designed to keep unwrapped foods fresh by retaining the natural moisture content of foods such as:

- Artichokes
- Asparagus
- Beets, topped
- Blueberries
- Currants
- Carrots
- Celery
- Cherries
- Corn
- Currants
- Greens, leafy
- Lettuce
- Parsley
- Peas, green
- Radishes
- Rhubarb
- Spinach
- Tomatoes, ripe

As in any refrigerated storage area, it is recommended that foods with strong odors be stored wrapped—foods such as:

- Broccoli
- Brussels sprouts
- Cabbage
- Cauliflower
- Green onions
- Parsnips
- Turnips

Low humidity setting

This refrigerated drawer is designed to provide lower humidity storage for items such as:

- Apples
- Apricots
- Grapes
- Mushrooms
- Nectarines
- Oranges
- Peaches
- Pears
- Raspberries
- Squash, summer
- Strawberries
- Tangerines

Sealed snack pan

The Sealed Snack Pan retains high humidity for the convenient storage of lunch meats and cheese, hors d'oeuvres, spreads and snacks.

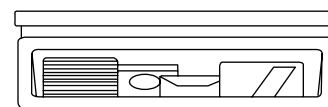

Drawer removal

Drawers at the bottom of the fresh food compartment will stop before coming all the way out of the refrigerator, to help prevent contents from spilling onto floor.

To remove a drawer, pull the drawer out. Lift the front of the drawer up and out of the wire holder. Lift the back of the drawer up and out.

To remove the drawers when the refrigerator door cannot be opened fully, the shelf above the drawers must be removed. Push the shelf back then lift up. Tilt the cover and take it out.

To replace a drawer, place the back of the drawer in the wire holder, making sure the extensions of the side of the drawer fit into the back of the wire holder. Lower the front of the drawer into the wire holder. Press firmly on the top of the drawer.

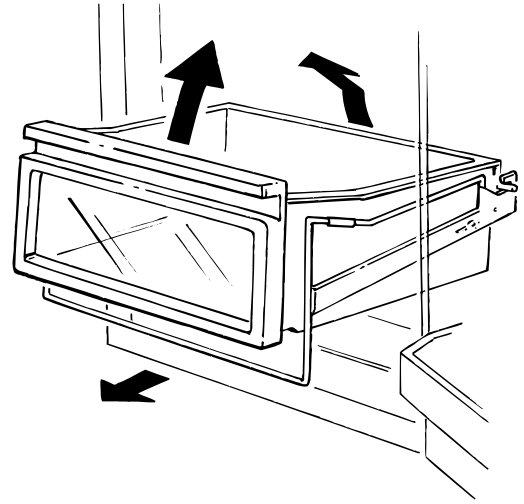

Shelves

Built - In Refrigerators

How to rearrange your shelves

Tempered glass shelves in the fresh food compartment and steel wire shelves in the freezer compartment are adjustable, enabling you to make efficient shelf arrangements to fit your family's food storage needs.

To remove shelves:

Tilt shelf up at front, then lift it up and out of tracks on rear wall of refrigerator.

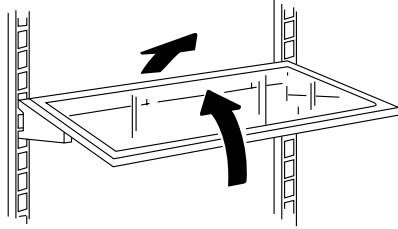

To replace shelves:

Select desired shelf height. With shelf front raised slightly, engage top lugs in tracks at rear of cabinet. Then lower front of shelf until it locks into position.

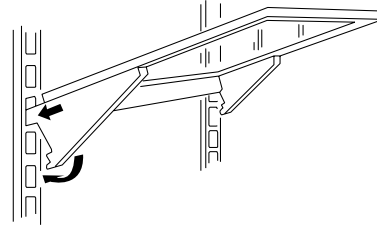

Door shelves

Some door shelves are adjustable and can be moved up and down to meet your storage needs.

To remove: Lift the shelf up and slide it towards you.

The divider (on some models) helps prevent tipping, spilling or sliding of small items stored on the door shelf.

Place index finger and middle finger on either side of the divider near the front and simply move it back and forth to fit your needs.

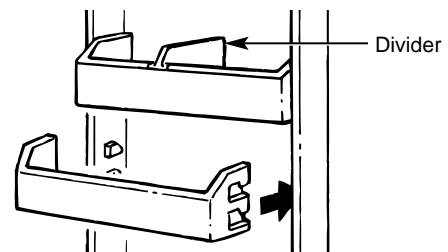

Quick space shelf

This shelf splits in half and slides under itself for storage of tall items on the shelf below.

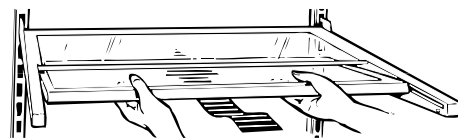

Removable wine rack (on some models)

The wine rack is designed to hold a bottle on its side. A good location for the wine rack is the Quick Space Shelf.

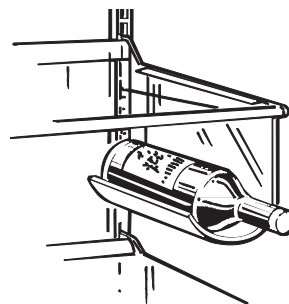

Shelves

Built - In Refrigerators

Deep door shelf

This shelf has only one position on the door.

To remove: Lift the shelf up and slide it towards you.

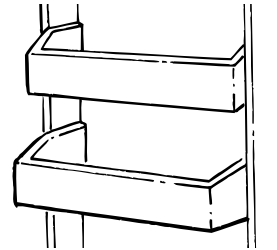

Quick shelf

This swing-down shelf provides extra shelf space when needed.

When you want to use it, pull the shelf forward as far as it goes, then lower it. Be careful not to force it down before it is pulled out all the way.

To raise it back into position, pull the shelf forward, push it up and slide it back fully until it stops.

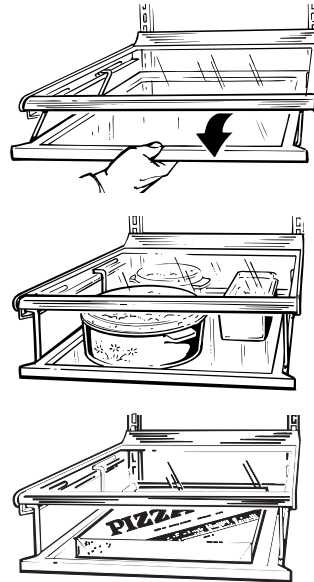

Freezer Baskets

Wire slide-out freezer baskets can be pulled out for easy access to frozen foods.

To remove: Pull shelf out. Lift the front of the basket up and then take it out.

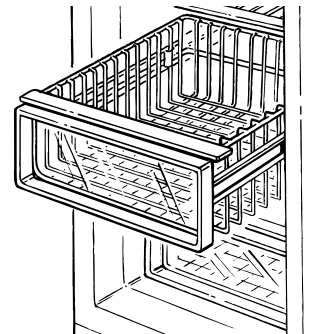

Cleaning outside

The water and ice dispenser spill shelf should be wiped dry immediately to prevent spotting. The grille is

easily removed by pressing on the back right corner. Water left on the shelf may leave deposits that you can remove by soaking in undiluted vinegar. You can also use a paste of non-precipitating water softener (such as Calgon brand) and water, or 1 teaspoon of citric acid powder per pint of hot tap water.

Soak until the deposit disappears or becomes loose enough to rinse away. Usually 30 minutes soaking time is adequate. Avoid using wax on the spill shelf and trim.

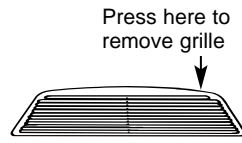

The door handles and trim can be cleaned with a cloth dampened with a solution of mild liquid dishwashing detergent and water. Dry with a soft cloth. Don't use wax on the door handles or trim.

The stainless steel panels and door handles (on some models) can be cleaned with a commercially available stainless steel cleaner using a clean, soft cloth.

Do not use appliance wax or polish on the stainless steel.

Cleaning inside

Inside the fresh food and freezer compartments should be cleaned at least once a year. Unplug the refrigerator before cleaning. If this is not practical, wring excess moisture out of sponge or cloth when cleaning around switches, lights or controls.

Use warm water and baking soda solution—about a tablespoon of baking soda to a quart of water. This both cleans and neutralizes odors. Rinse thoroughly with water and wipe dry.

Other parts of the refrigerator—including door gaskets, meat and vegetable drawers, ice storage bin and all plastic parts—can be cleaned the same way. After cleaning door gaskets, apply a thin layer of petroleum jelly to the door gaskets at the hinge side. This helps keep the gaskets from sticking and bending out of shape. Do not use cleansing powders or other abrasive cleaners.

Avoid cleaning cold glass shelves with hot water because the extreme temperature difference may cause them to break.

To help prevent odors, leave an open box of baking soda in the rear of the refrigerator, on the top shelf. Change the box every 3 months. An open box of baking soda in the freezer will absorb stale freezer odors.

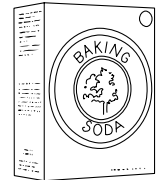

Do not wash any plastic parts from your refrigerator in your automatic dishwasher.

Cleaning the condenser fins

To clean the condenser fins:

First turn off the power at the circuit breaker or fuse box. Wait about 30 minutes for the condenser area to cool. Then remove the decorative panel by lifting up and toward you.

Use a soft bristle brush to loosen dust and lint on the condenser fins. Use a vacuum hose to remove soil.

After cleaning: Reconnect power at the fuse box or circuit breaker.

Replace the decorative panel.

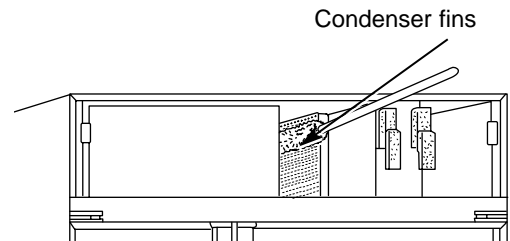
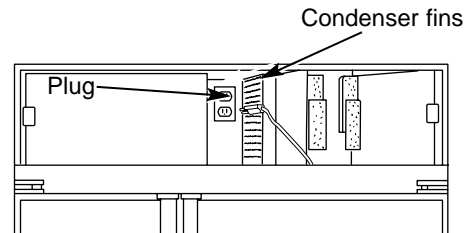
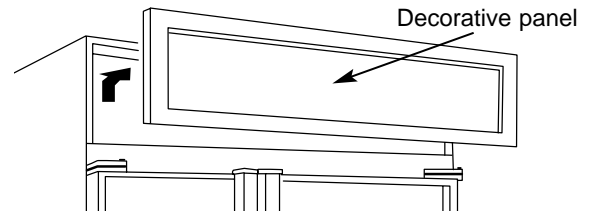

Preparing for vacation

For extended vacations or absences, remove food and shut off power to the refrigerator at the fuse box or circuit breaker. Clean the interior with a baking soda solution of 1 tablespoon of soda to 1 quart of water. Wipe dry. To prevent odors, leave an open box of soda in the refrigerator. Leave doors open.

For shorter vacations, remove perishable foods and leave controls at regular settings. However, if the room temperature is expected to drop below 60°F., follow the same instructions as for extended vacations.

Move the icemaker feeler arm to the STOP (up) position and be sure to shut off the water supply to the refrigerator.

Preparing to move

Secure all loose items such as grille, shelves and drawers by taping them securely in place to prevent damage.

Be sure the refrigerator stays in an upright position during moving.

Light bulb replacement in the fresh food compartment

There are upper and lower light bulbs in the fresh food compartment.

To replace a bulb:

1. Turn off power at the circuit breaker or fuse box.
2. Remove the light shield from the top fresh food light by pushing the front end up and pulling it toward you to release it from the rear retaining lip. (It may bend slightly.)

To change the bottom refrigerator light, pull out the top drawer, look to the rear of the fresh food compartment and replace bulb as needed.

3. Replace with the same size bulb, reinstall the shield for the upper fresh food light, and turn the power on.

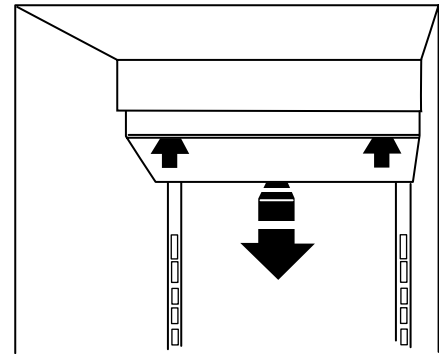

To reinstall the upper fresh food shield, hook the front edge first, then push it up and back until the shield rests in place.

Light bulb replacement in the freezer compartment

To replace a bulb:

1. Turn off power at the circuit breaker or fuse box.
2. Remove the freezer light shield by pulling the front edge down and free and then pull it toward you.
3. Replace with the same size bulb, reinstall the shield, and turn the power on.

To replace the freezer shield, set the back edge on the rear tabs and then push up in the front until it rests in place.

You may bend the shield slightly to help in removal and replacement.

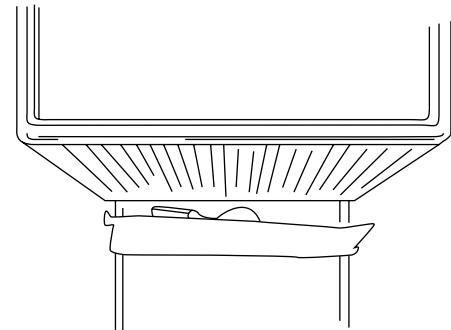

INSTALLATION REQUIREMENTS

IMPORTANT...Please Read Carefully.

Refrigerator location

Do not install refrigerator where temperature will be below 60°F (16°C) because it will not run often enough to maintain proper temperatures.

Do install it on a floor strong enough to support a fully loaded refrigerator.

Clearances

If the refrigerator is to be installed in a corner, allow 2" between the hinges of the refrigerator and the wall to ensure a 90° door opening capability.

No other clearances at top, sides, or back are required.

Leveling

This model has 4-point leveling. All 4 corners are supported by leveling legs. The front wheels are non-adjustable; they are only used for positioning the unit.

- To level the back of the unit, turn hex nut located above the front wheels.
- To level the front of the unit, use a 1/4" open end wrench and adjust the leveling legs.
- Turn hex nut or front leveling leg clockwise to raise the unit, counter-clockwise to lower the unit.

See the Installation Instructions (Pub. No. 49-6473-36), (Pub. No. 49-6462-42), (Pub. No. 49-6457-48) for complete directions.

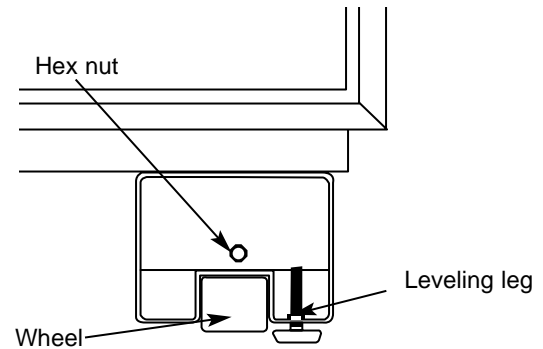

The Problem Solver

Built - In Refrigerators

Questions?

*Use this
problem
solver!*

PROBLEM	POSSIBLE CAUSE
Refrigerator does not operate	<ul style="list-style-type: none"> • May be in defrost cycle when motor does not operate for about 30 minutes. • Freezer control is in the OFF position. • If the interior light is not on, the refrigerator may not be plugged in at the wall outlet. • If the plugs are secure and the refrigerator still fails to operate, plug a lamp into the same outlet to determine if there is a tripped circuit breaker or burned-out fuse.
Motor operates for long periods	<ul style="list-style-type: none"> • Modern refrigerators with more storage space and a larger freezer compartment require more operating time. • Normal when refrigerator is first delivered to your home—usually requires 24 hours to completely cool down. • Large amounts of food placed in refrigerator to be cooled or frozen. • Hot weather—frequent door openings. • Door left open. • Temperature controls are set too cold. • Condenser needs cleaning.
Motor starts and stops frequently	<ul style="list-style-type: none"> • Temperature control starts and stops motor to maintain even temperatures.
Vibration or rattling	<ul style="list-style-type: none"> • If refrigerator vibrates, more than likely it is not resting solidly on the floor. The front leveling legs need adjusting, or floor is weak or uneven. Adjust leveling legs or call your installer. • If dishes vibrate on shelves, try moving them. Slight vibration is normal.
Operating sounds	<ul style="list-style-type: none"> • The high speed compressor motor required to maintain near zero temperatures in the large freezer compartment may produce higher sound levels than your old refrigerator. • Normal fan air flow—one fan blows cold air through the refrigerator and freezer compartments—another fan cools the compressor motor. <p>These NORMAL sounds will also be heard from time to time:</p> <ul style="list-style-type: none"> • Defrost timer switch clicks at defrost. • Defrost water dripping. • Temperature control clicks ON or OFF. • Refrigerant boiling or gurgling. • Cracking or popping of cooling coils caused by expansion and contraction during defrost and refrigeration following defrost. • Ice cubes dropping into the bin and water running in pipes as icemaker refills.
Foods dry out	<ul style="list-style-type: none"> • Foods not covered, wrapped or sealed properly.
Fresh food or freezer compartment too warm	<ul style="list-style-type: none"> • Temperature control not set cold enough. • Warm weather—frequent door openings. • Door left open for too long a time. • Package may be holding door open.

The Problem Solver

Built - In Refrigerators

*Questions?
Use this
problem
solver!*

PROBLEM	POSSIBLE CAUSE
Doors not closing properly	<ul style="list-style-type: none"> • Refrigerator not level. Adjust leveling legs or call the installer. When cabinet is level, doors will close gently and securely.
Frost or ice crystals on frozen food	<ul style="list-style-type: none"> • Door may have been left ajar or package holding door open. • Too frequent or too long door openings. • Frost within package is normal.
Automatic icemaker does not work	<ul style="list-style-type: none"> • Icemaker feeler arm in STOP (up) position. • Water supply turned off or not connected. • Freezer compartment too warm. • Cubes too small—water shutoff valve connecting refrigerator to home water line may be clogged. • Sometimes cubes fuse to the side of the ice mold and hold the feeler arm in the STOP (up) position. Remove this ice to restart the icemaker. • When reaching for cubes by hand, you may have pushed the feeler arm into the STOP (up) position by mistake. • Piled up cubes in storage bin may cause icemaker to shut off prematurely. With icemaker feeler arm in STOP (up) position, level cubes in bin by hand.
Slow ice cube freezing	<ul style="list-style-type: none"> • Door may have been left open. • Turn temperature of freezer compartment colder.
Ice cubes have odor/taste	<ul style="list-style-type: none"> • Old cubes need to be discarded. • Ice storage bin needs to be emptied and washed. • Unsealed packages in refrigerator and/or freezer compartments may be transmitting odor/taste to ice cubes. • Interior of refrigerator needs cleaning. • Poor-tasting incoming water. Install a water filter.
Cube dispenser does not work	<ul style="list-style-type: none"> • No ice cubes. Remove storage bin. If cubes are frozen to wire arm, remove cubes. • No ice cubes. Icemaker turned off or water supply turned off. • Irregular ice clumps in storage container. Break up as many as you can with fingertip pressure and discard the remaining clumps.
Water has poor taste/odor	<ul style="list-style-type: none"> • If water dispenser has not been used for an extended period, dispense water in regular manner until all water in reservoir is replenished with fresh water. • Poor-tasting incoming water. Install a water filter. See the Water Filter Accessory section.
Water in first glass is warm	<ul style="list-style-type: none"> • Allow about 24 hours for water to cool to proper temperature after refrigerator is first installed. • If water dispenser has not been used for extended period, water in the first glass will not be as cool as in succeeding glasses. • If water reservoir has been drained, allow several hours for replenished supply to chill.

The Problem Solver

Built - In Refrigerators

Questions?

*Use this
problem
solver!*

PROBLEM	POSSIBLE CAUSE
Ice clumps form in the storage bin	<ul style="list-style-type: none">• If you don't use the ice very often, ice clumps may form in the storage bin and can clog the dispenser. Remove the storage bin from the freezer and break up ice clumps with your hands. Throw away any clumps that you can't break up.
Water dispenser does not work	<ul style="list-style-type: none">• Water supply line turned off or not connected.• Supply line may be clogged with sediment.• If no water is dispensed when the icemaker is first installed, there may be air in the water system. Press the dispenser pad for at least two minutes to remove trapped air from the water line and to fill the water system.
Moisture forms on cabinet surface between the doors	<ul style="list-style-type: none">• Not unusual during periods of high humidity. If problem persists, call for service.
Moisture collects inside	<ul style="list-style-type: none">• Too frequent or too long door openings.• In humid weather, air carries moisture into refrigerator when doors are opened.
Water on the floor	<ul style="list-style-type: none">• If you use a glass over 6 inches tall, you may be jamming the cubes in the funnel chute. They can fuse inside the chute and drop out later, leaving water or ice on the floor.
Refrigerator has odor	<ul style="list-style-type: none">• Foods with strong odors should be tightly covered.• Check for spoiled food.• Interior needs cleaning.• Keep open box of baking soda in refrigerator; replace every 3 months.
Interior light does not work	<ul style="list-style-type: none">• No power at outlet. Call installer or electrician.• Light bulb needs replacing.• Check fuse and circuit breaker.
Uneven spacing or gaps between doors and kitchen cabinet	<ul style="list-style-type: none">• Kitchen cabinets are not level or square. Call the installer or cabinetmaker.
Poor door alignment or one door higher than the other	<ul style="list-style-type: none">• Refrigerator not level. Adjust leveling legs so refrigerator is resting solidly on the floor and is level side to side and front to back.

**If you need more help...call toll free:
GE Answer Center®, 800.626.2000
consumer information service**

With the purchase of your new Monogram appliance, receive the assurance that if you ever need information or assistance from GE, we will be there. All you have to do is call—toll-free!

GE Answer Center[®]

***In the USA:
800.626.2000***

Whatever your question about any Monogram major appliance, GE Answer Center[®] information service is available to help. Your call—and your question—will be answered promptly and courteously. And you can call any time. GE Answer Center[®] service is open 24 hours a day, 7 days a week.

In Canada, call 1.888.880.3030.

In-Home Repair Service

***In the USA:
800.444.1845***

***In Canada:
1.888.880.3030***

A GE consumer service professional will provide expert repair service, scheduled at a time that's convenient for you. Many GE Consumer Service company-operated locations offer you service today or tomorrow, or at your convenience (7:00 a.m. to 7:00 p.m. weekdays, 9:00 a.m. to 2:00 p.m. Saturdays). Our factory-trained technicians know your appliance inside and out—so most repairs can be handled in just one visit.

For Customers With Special Needs...

***In the USA:
800.626.2000***

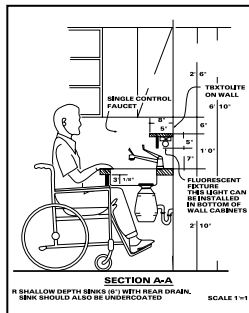

GE offers Braille controls for a variety of GE appliances, and a brochure to assist in planning a barrier-free kitchen for persons with limited mobility.

Consumers with impaired hearing or speech who have access to a TDD or a conventional teletypewriter may call 800.TDD.GEAC (800.833.4322) to request information or service.

Service Contracts

***In the USA:
800.626.2224***

***In Canada:
1.888.880.3030***

You can have the secure feeling that GE Consumer Service will still be there after your warranty expires. Purchase a GE contract while your warranty is still in effect and you'll receive a substantial discount. With a multiple-year contract, you're assured of future service at today's prices.

Parts and Accessories

***In the USA:
800.626.2002***

***In Canada:
1.888.880.3030***

Individuals qualified to service their own appliances can have parts or accessories sent directly to their home. The GE parts system provides access to over 47,000 parts...and all GE Genuine Renewal Parts are fully warranted. VISA, MasterCard and Discover cards are accepted.

User maintenance instructions contained in this guide cover procedures intended to be performed by any user. Other servicing generally should be referred to qualified service personnel. Caution must be exercised, since improper servicing may cause unsafe operation.

**Consumer Product
Ownership Registration
Important Mail Today**

GE Appliances



Place
1st Class
Letter
Stamp
Here

General Electric Company
Warranty Registration Department
P.O. Box 32150
Louisville, KY 40232-2150

Consumer Product Ownership Registration

Dear Customer:

Thank you for purchasing our product and thank you for placing your confidence in us. We are proud to have you as a customer!

Follow these three steps to protect your new appliance investment:

1

Complete and mail your Consumer Product Ownership Registration today. Have the peace of mind of knowing we can contact you in the unlikely event of a safety modification.

2

After completing this registration, write your model and serial numbers in this guide. You will need this information should you require service. The service number in the USA: 800.444.1845. In Canada: 1.888.880.3030.

3

Read your "Use and Care Guide" carefully. It will help you operate your new appliance properly. If you have questions, or need more information in the USA, call the GE Answer Center® 800.626.2000. In Canada call 1.888.880.3030

Important: To ensure that your product is registered, mail the separate product registration card. If the separate product registration card is missing, fold and mail the form below. No envelope is needed.

FOLD HERE

Consumer Product Ownership Registration



Product Model Serial
Built-In Refrigerator

Mr. Ms. Mrs. Miss

First Name _____ Last Name _____
Street Address _____
Apt. # _____
City _____ State _____ Zip Code _____
Date Placed In Use _____ Day _____ Year _____ Phone Number _____-_____-_____



TAPE CLOSED

WHAT IS COVERED

From the Date of the Original Purchase

YOUR MONOGRAM REFRIGERATOR WARRANTY

Staple sales slip or cancelled check here. Proof of original purchase date is needed to obtain service under warranty.

FULL TWO-YEAR WARRANTY

For two years from date of original purchase, we will provide, free of charge, *parts and service labor in your home* to repair or replace *any part of the refrigerator* that fails because of a manufacturing defect.

FULL FIVE-YEAR WARRANTY

For five years from date of original purchase, we will provide, free of charge, *parts and service labor in your home* to repair or replace *any part of the sealed refrigerating system* (the compressor, condenser, evaporator and all connecting tubing) that fails because of a manufacturing defect.

LIMITED ADDITIONAL SEVEN-YEAR WARRANTY ON THE SEALED SYSTEM

For the sixth through twelfth year from date of original purchase, we will provide, free of charge, *replacement parts* for *any part of the sealed refrigerating system* (the compressor, condenser, evaporator and all connecting tubing) that fails because of a manufacturing defect. You pay for the service trip to your home and for service labor charges.

.....

This warranty is extended to the original purchaser and any succeeding owner for products purchased for ordinary home use in Canada.

All warranty service will be provided by our Factory Service Centers or by our authorized Customer Care® servicers during normal working hours.

Should your appliance need service, during warranty period or beyond, call 1.888.880.3030.

WHAT IS NOT COVERED

- Service trips to your home to teach you how to use the product.

Read your Use and Care material.

If you then have any questions about operating the product, please contact your dealer or our Consumer Relations office at the address below, or call, toll free:

1.888.880.3030

- Replacement of house fuses or resetting of circuit breakers.
- Damage to the product caused by accident, fire, floods or acts of God.

- Failure of the product if it is used for other than its intended purpose or used commercially.

- Improper installation.

If you have an installation problem, contact your dealer or installer. You are responsible for providing adequate electrical, plumbing and other connecting facilities.

WARRANTOR IS NOT RESPONSIBLE FOR CONSEQUENTIAL DAMAGES.

Some provinces do not allow the exclusion or limitation of incidental or consequential damages, so the above limitation or exclusion may not apply to you. This warranty gives you specific legal rights, and you may also have other rights which vary from province to province. To know what your legal rights are in your province, consult your local or provincial consumer affairs office.

Warrantor: Camco Inc. If further help is needed concerning this warranty, write: Manager, Consumer Relations, Camco Inc., 1 Factory Lane, Suite 310, Moncton, N.B. E1C 9M3.

YOUR MONOGRAM REFRIGERATOR WARRANTY
Staple sales slip or cancelled check here. Proof of original purchase date is needed to obtain service under warranty.

WHAT IS COVERED

From the Date of the Original Purchase

FULL TWO-YEAR WARRANTY

For two years from date of original purchase, we will provide, free of charge, *parts and service labor in your home* to repair or replace *any part of the refrigerator* that fails because of a manufacturing defect.

FULL FIVE-YEAR WARRANTY

For five years from date of original purchase, we will provide, free of charge, *parts and service labor in your home* to repair or replace *any part of the sealed refrigerating system* (the compressor, condenser, evaporator and all connecting tubing) that fails because of a manufacturing defect.

LIMITED ADDITIONAL SEVEN-YEAR WARRANTY ON THE SEALED SYSTEM

For the sixth through twelfth year from date of original purchase, we will provide, free of charge, *replacement parts* for *any part of the sealed refrigerating system* (the compressor, condenser, evaporator and all connecting tubing) that fails because of a manufacturing defect. You pay for the service trip to your home and for service labor charges.

.....
This warranty is extended to the original purchaser and any succeeding owner for products purchased for ordinary home use in the 48 mainland states, Hawaii and Washington, D.C. In Alaska the warranty is the same except that it is LIMITED because you must pay to ship the product to the service shop or for the service technician's travel costs to your home.

All warranty service will be provided by our Factory Service Centers or by our authorized Customer Care® servicers during normal working hours.

Should your appliance need service, during warranty period or beyond, in the U.S.A. call 800.444.1845. In Canada: 888.880.3030.

WHAT IS NOT COVERED

- Service trips to your home to teach you how to use the product.

Read your Use and Care material.

If you then have any questions about operating the product, please contact your dealer or our Consumer Affairs office at the address below, or call, toll free:

GE Answer Center®
800.626.2000
consumer information service

- Replacement of house fuses or resetting of circuit breakers.

- Damage to the product caused by accident, fire, floods or acts of God.

- Failure of the product if it is used for other than its intended purpose or used commercially.

- Improper installation.

If you have an installation problem, contact your dealer or installer. You are responsible for providing adequate electrical, plumbing and other connecting facilities.

- Loss of food due to spoilage.

WARRANTOR IS NOT RESPONSIBLE FOR CONSEQUENTIAL DAMAGES.

Some states do not allow the exclusion or limitation of incidental or consequential damages, so the above limitation or exclusion may not apply to you. This warranty gives you specific legal rights, and you may also have other rights which vary from state to state.

To know what your legal rights are in your state, consult your local or state consumer affairs office or your state's Attorney General.

Warrantor: General Electric Company. If further help is needed concerning this warranty, write: Manager—Consumer Affairs, GE Appliances, Louisville, KY 40225



Part No. 162D3947P006
Pub No. 49-60037-1

Free Manuals Download Website

<http://myh66.com>

<http://usermanuals.us>

<http://www.somanuals.com>

<http://www.4manuals.cc>

<http://www.manual-lib.com>

<http://www.404manual.com>

<http://www.luxmanual.com>

<http://aubethermostatmanual.com>

Golf course search by state

<http://golfingnear.com>

Email search by domain

<http://emailbydomain.com>

Auto manuals search

<http://auto.somanuals.com>

TV manuals search

<http://tv.somanuals.com>