



Use and Care Guide

Built-In Electric Oven



Safety Instructions.....3, 4



Operating Instructions, Tips

Aluminum Foil	4, 12, 17
Automatic Oven Shut Off	9
Features	5
Oven	6-18
Baking	10-13
Broiling, Broiling Guide	17, 18
Clock and Timers	6, 7
Control Panel	6
Fan	8, 10, 12, 13, 15, 17, 20, 21
Light; Bulb Replacement	8, 23
Lower Oven Controls	10
Preheating	10
Roasting, Roasting Guide	15, 16
Shelves	9, 10
Timed Baking	12, 13
Vent	9
Power Outage	7
Self-Cleaning Instructions	19-22



Problem Solver.....26

Thermostat Adjustment-	
<i>Do It Yourself</i>	14
More questions?...call	
<i>GE Answer Center® 800.626.2000</i>	



Care and Cleaning.....22-25

Broiler Pan and Rack	23
Lift-Off Oven Door	24
Porcelain Oven Interior	25
Self-Cleaning Instructions	19-22
Shelves	23



Consumer Services.....27

Appliance Registration	2
Important Phone Numbers	27
Model and Serial Number Location	2
Removal of Packaging Tape	2
Warranty	Back Cover

Models: JKP13 JKP27
 JKP14 JRP14
 JKP15 JRP15
 JKP26 JRP24

GE Appliances

164D2966P122



HELP US HELP YOU...

Before using your oven, read this guide carefully.

It is intended to help you operate and maintain your new oven properly.

Keep it handy for answers to your questions.

If you don't understand something or need more help, call:

GE Answer Center®

800.626.2000

24 hours a day, 7 days a week

How to Remove Packaging Tape

To assure no damage is done to the finish of the product, the safest way to remove adhesive left from packaging tape on new appliances is an application of a household liquid dishwashing detergent, mineral oil or cooking oil. Apply with a soft cloth and allow to soak. Wipe dry and then apply an appliance polish to thoroughly clean and protect the surface.

NOTE: The plastic tape must be removed from the chrome trim on oven parts. It cannot be removed if it is baked on.

Write down the model and serial numbers.

You'll find them on a label on the front of the oven behind the oven door.

These numbers are also on the Consumer Product Ownership Registration Card that came with your oven. Before sending in this card, please write these numbers here:

Model Number

Serial Number

Use these numbers in any correspondence or service calls concerning your oven.

Save time and money. Before you request service...

Check the Problem Solver in the back of this guide. It lists causes of minor operating problems that you can correct yourself.

IF YOU NEED SERVICE...

To obtain service, see the Consumer Services page in the back of this guide.

We're proud of our service and want you to be pleased. If for some reason you are not happy with the service you receive, here are three steps to follow for further help.

FIRST, contact the people who serviced your appliance. Explain why you are not pleased. In most cases, this will solve the problem.

NEXT, if you are still not pleased, write all the details—including your phone number—to:

Manager, Consumer Relations
GE Appliances
Appliance Park
Louisville, KY 40225

FINALLY, if your problem is still not resolved, write:

Major Appliance Consumer Action Panel
20 North Wacker Drive
Chicago, IL 60606

IMPORTANT SAFETY INSTRUCTIONS

Read all instructions before using this appliance.



IMPORTANT SAFETY NOTICE

- **The California Safe Drinking Water and Toxic Enforcement Act** requires the Governor of California to publish a list of substances known to the state to cause birth defects or other reproductive harm, and requires businesses to warn customers of potential exposure to such substances.
- **The fiberglass insulation in self-cleaning ovens gives off a very small amount of carbon monoxide during the cleaning cycle.** Exposure can be minimized by venting with an open window or using a ventilation fan or hood.

When using electrical appliances, basic safety precautions should be followed, including the following:

- Use this appliance only for its intended use as described in this guide.
- Have the installer show you the location of the circuit breaker or fuse. Mark it for easy reference.
- Be sure your appliance is properly installed and grounded by a qualified technician in accordance with the provided Installation Instructions.
- Do not attempt to repair or replace any part of your oven unless it is specifically recommended in this guide. All other servicing should be referred to a qualified technician.
- Before performing any service, **DISCONNECT THE OVEN POWER SUPPLY AT THE HOUSEHOLD DISTRIBUTION PANEL BY REMOVING THE FUSE OR SWITCHING OFF THE CIRCUIT BREAKER.**
- Do not leave children alone—Children should not be left alone or unattended in an area where appliance is in use. They should never be allowed to sit or stand on any part of the appliance.
- Do not allow anyone to climb, stand or hang on the door. They could damage the oven or cause severe personal injury.
- **CAUTION: ITEMS OF INTEREST TO CHILDREN SHOULD NOT BE STORED IN CABINETS ABOVE AN OVEN. CHILDREN CLIMBING ON THE OVEN TO REACH ITEMS COULD BE SERIOUSLY INJURED.**
- Do not store flammable materials in an oven.

- Teach children not to play with the controls or any other part of the oven.
- Always keep combustibles wall coverings, curtains or drapes a safe distance from your oven.
- Never wear loose-fitting or hanging garments while using the appliance. Be careful when reaching for items stored in cabinets over the oven. Flammable material could be ignited if brought in contact with hot heating elements and may cause severe burns.
- **DO NOT STORE OR USE COMBUSTIBLE MATERIALS, GASOLINE OR OTHER FLAMMABLE VAPORS AND LIQUIDS IN THE VICINITY OF THIS OR ANY OTHER APPLIANCE.**



- Use only dry pot holders—Moist or damp pot holders on hot surfaces may result in burns from steam. Do not let pot holders touch hot heating elements. Do not use a towel or other bulky cloth. Such cloths can catch fire on a hot heating element.
- Always keep dish towels, dish cloths, pot holders and other linens a safe distance from your oven.
- Always keep wooden and plastic utensils and canned food a safe distance away from your oven.
- For your safety, never use your appliance for warming or heating the room.



- Do not let cooking grease or other flammable materials accumulate in or near the oven.
- Be sure the oven is securely installed in a cabinet that is firmly attached to the house structure. Never allow anyone to climb, sit, stand or hang on the oven door.



- Do not use water on grease fires. Smother fire or flame or use a multi-purpose dry chemical or foam-type fire extinguisher.

Flame in the oven can be smothered completely by closing the oven door and turning the oven off or by using a multi-purpose dry chemical or foam-type fire extinguisher.

(continued next page)

Important Safety Instructions



IMPORTANT SAFETY INSTRUCTIONS

(continued)

- **Do not touch the heating elements or the interior surface of the oven.** These surfaces may be hot enough to burn even though they are dark in color. During and after use, do not touch, or let clothing or other flammable materials contact any interior area of the oven; allow sufficient time for cooling first.

Potentially hot surfaces include the oven vent openings and surfaces near the openings, crevices around the oven door, the edges of the door window and metal trim parts above the door.

Remember: The inside surface of the oven may be hot when the door is opened.

- **When cooking pork,** follow the directions exactly and always cook the meat to an internal temperature of at least 170°F. This assures that, in the remote possibility that trichina may be present in the meat, it will be killed and the meat will be safe to eat.

Oven

- **Stand away from the oven when opening the oven door.** Hot air or steam which escapes can cause burns to hands, face and/or eyes.
- **Do not heat unopened food containers.** Pressure could build up and the container could burst, causing an injury.
- **Keep the oven vent duct unobstructed.**



- **Keep the oven free from grease buildup.**
- **Place the oven shelf in the desired position while the oven is cool.** If the shelves must be handled when hot, do not let the pot holder contact the heating elements in the oven.
- **Never leave the oven door open** when you are not watching the oven.
- **Pulling out the shelf to the shelf stop is a convenience in lifting heavy foods.** It is also a precaution against burns from touching the hot surfaces of the door or the oven walls.
- **When using cooking or roasting bags in the oven,** follow the manufacturer's directions.

- **Do not use your oven to dry newspapers.** If overheated, they can catch fire.
- **Do not leave paper products, cooking utensils, or food in the oven when not in use.**
- **Do not use oven for storage area.** Items stored in an oven can ignite.
- **After broiling, always take the broiler pan out of the oven and clean it.** Leftover grease in the broiler pan can catch fire next time you use the pan.
- **Never leave jars or cans of fat drippings on or near your oven.**

Self-Cleaning Oven

- **Do not clean the oven door gasket.** The door gasket is essential for a good seal. Care should be taken not to rub, damage or move the gasket.
- **Do not use oven cleaners.** No commercial oven cleaner or oven liner protective coating of any kind should be used in or around any part of the oven. Residue from oven cleaners will damage the inside of the oven when the self-cleaning cycle is used.
- **Clean only parts listed in this Use and Care Guide.**
- **Before self-cleaning the oven,** remove the broiler pan and other cookware.
- **Do not use aluminum foil to line oven bottoms, except as suggested in guide.** Improper installation of aluminum foil may result in a risk of electric shock or fire.
- **Be sure to wipe up excess spillage before starting the self-cleaning operation.**
- **If the self-cleaning mode malfunctions,** turn the oven off and disconnect the power supply. Have it serviced by a qualified technician.

SAVE THESE INSTRUCTIONS

FEATURES OF YOUR OVEN

(Appearance may vary between models.)



Important Safety Instructions

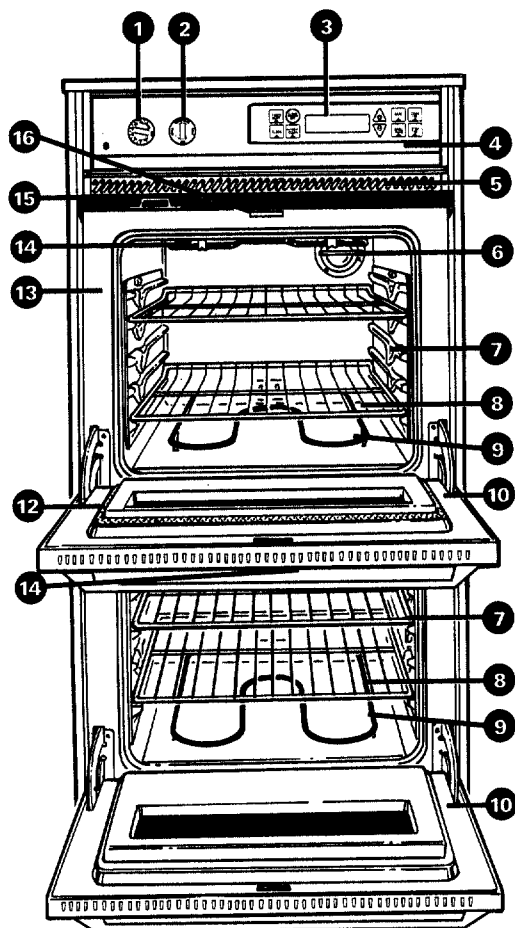

JRP24 JKP26 JKP27

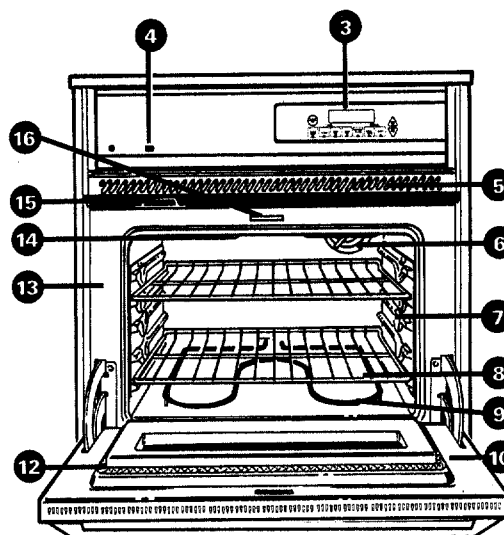
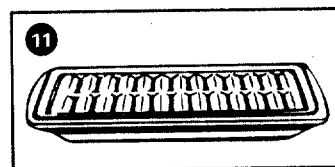

JKP13 JKP14 JKP15 JRP14 JRP15

Feature Index	Explained on page
1 Oven Temp Knob Operates the standard clean lower oven. (on some models)	10, 14
2 Oven Set Knob Operates the standard clean lower oven. (on some models)	10
3 Oven Control, Clock and Timer	6, 7
4 Oven Light Switch Lets you turn interior oven light(s) on and off.	8
5 Oven Vent Grille	19
6 Oven Interior Light	8, 23
7 Oven Shelf Supports Shelf positions for cooking are suggested in the Baking, Roasting and Broiling sections.	9
8 Oven Shelves with Stop-Locks	9, 10, 23

Feature Index	Explained on page
9 Bake Element May be lifted gently for wiping oven floor.	4, 22
10 Lift-Off Oven Door with Broil Stop Position Easily removed for oven cleaning.	3, 4, 17, 19, 24
11 Broiler Pan and Rack Do not clean in self-cleaning oven.	4, 17, 23
12 Oven Door Gasket	4, 19, 24
13 Model and Serial Numbers	2
14 Oven Broil Element	4, 17, 22
15 Oven Vent	4, 9
16 Automatic Oven Door Latch Upper self-cleaning oven. (on some models)	19-21

Features of Your Oven



FEATURES OF YOUR OVEN CONTROL

Your model will include one of these controls.

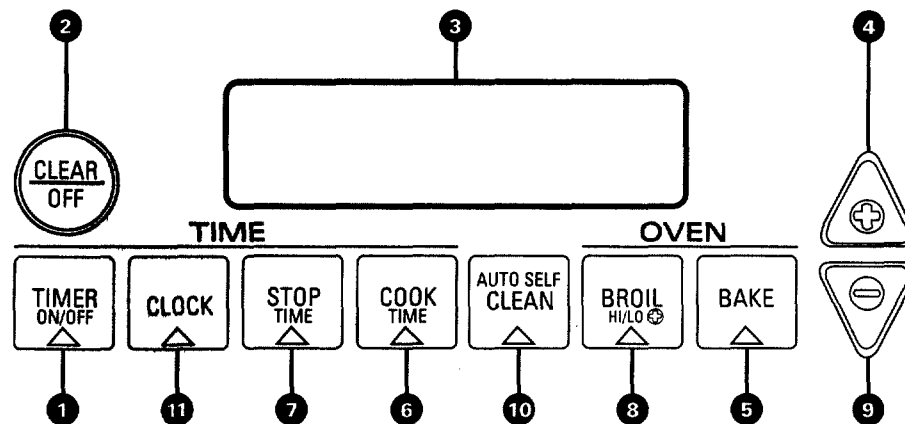
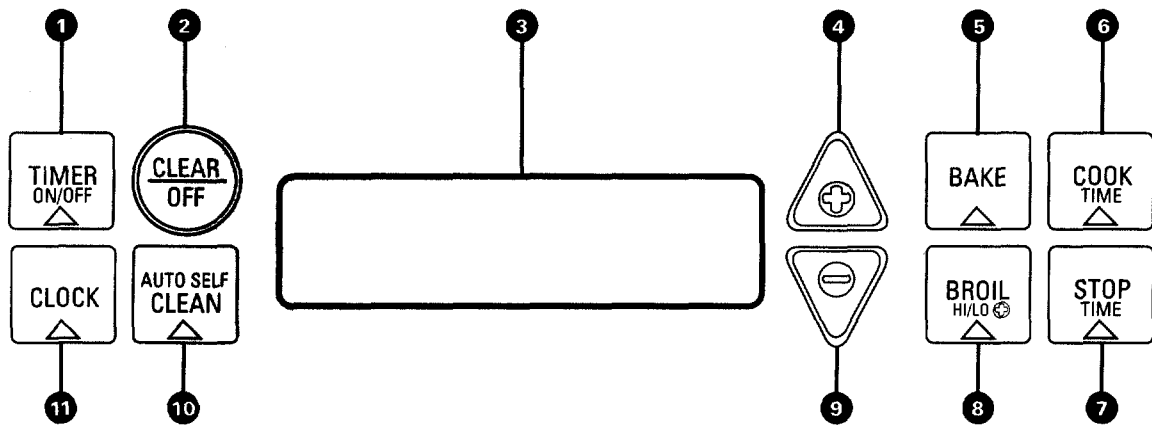

- 1. TIMER ON/OFF.** Press this pad to select the timer function.

To set timer, first press the **TIMER ON/OFF** pad. Then press the **INCREASE** or **DECREASE** pad to change the time.

To cancel the timer, press and hold the **TIMER ON/OFF** pad, until the word "TIMER" disappears from the display.

- 2. CLEAR/OFF.** Press this pad to cancel all oven operations except clock and timer.
- 3. DISPLAY.** Shows the operations you have selected, the time of day and the cooking or cleaning status.
- 4. INCREASE.** Short taps to this pad increase the time or temperature by small amounts. Press and hold the pad to increase the time or temperature by larger amounts.
- 5. BAKE.** Press this pad to select the bake function.
- 6. COOK TIME.** Press this pad for Timed Bake operations.
- 7. STOP TIME.** Use this pad along with the **COOK TIME** or **AUTO SELF CLEAN** pad to set the oven to stop automatically at a time you select.

- 8. BROIL.** Press this pad to select the broil function.

9. DECREASE. Short taps to this pad decrease the time or temperature by small amounts. Press and hold the pad to decrease the time or temperature by larger amounts.

- 10. AUTO SELF CLEAN.** Press this pad to select self-cleaning function. See the Operating the Self-Cleaning Oven section.

- 11. CLOCK.** To set clock, first press the **CLOCK** pad. Then press the **INCREASE** or **DECREASE** pad to change the time of day.

If "F— and a number" flashes in the display and the oven control signals this indicates function error code. Press the **CLEAR/OFF** pad. Allow the oven to cool for one hour. Put the oven back into operation. If function error code repeats, disconnect the power to the oven and call for service.

OVEN CONTROL, CLOCK AND TIMER



Lock

The clock must be set for the automatic oven timing functions to work properly. The time of day cannot be changed during a Timed Bake or Self-Clean cycle.

To Set the Clock



1. Press the CLOCK pad.



2. Press the INCREASE or DECREASE pad to set the time of day.

Timer

The timer is a minute timer; it does not control oven operations. The maximum setting on the timer is 9 hours and 55 minutes.

To Set the Timer



1. Press the TIMER ON/OFF pad.



2. Press the INCREASE or DECREASE pad to set the amount of time on the timer.



The timer will start automatically within a few seconds of releasing the INCREASE or DECREASE pad. The timer, as you are setting it, will display seconds until one minute is reached. Then it will display minutes and seconds until 60 minutes is reached.

After 60 minutes, it will display hours ("HR" now appears in display) and minutes until the maximum time of 9 hours and 55 minutes is reached.

To Reset the Timer

If "TIMER" is displayed, press the INCREASE or DECREASE pad until desired time is reached.

If "TIMER" is not displayed, press the TIMER ON/OFF pad first, then follow the instructions above to set the timer.

To Cancel the Timer

Press and hold the TIMER ON/OFF pad until the word "TIMER" disappears from the display.

End of Cycle Tone

The end of cycle tone is a series of three beeps followed by one beep every six seconds. If you would like to remove the signal that beeps every six seconds, press and hold the CLEAR/OFF pad for 10 seconds.

To return the signal that beeps every six seconds, press and hold the CLEAR/OFF pad for 10 seconds.

Display Messages

- If "door" appears in the display, LOCK flashes and the oven control signals, you set the self-clean cycle and did not shut the door.
- If "door" only appears in the display, the oven door is open and needs to be closed.
- If "LOCK" only appears in the display, the oven door is in the locked position. BAKE, BROIL and COOK TIME cannot be set if the door is in the locked position.

Power Outage

After a power outage, when power is restored, the display will flash and time shown will no longer be correct—for example, after a 5-minute power interruption the clock will be 5 minutes slow.

The display flashes until the clock is reset. All other functions that were in operation when the power went out will have to be programmed again.



USING YOUR OVEN

Before Using the Oven

1. Look at the controls. Be sure you understand how to set them properly.
2. Check the oven interior. Look at the shelves. Take a practice run at removing and replacing them properly to give sure, sturdy support.
3. Read over the information and tips that follow.
4. Keep this guide handy so you can refer to it, especially during the first weeks of using your new oven.

NOTE:

- A fan may automatically turn on and off to cool internal parts. This is normal, and the fan may continue to run even after the oven is turned off.
- You may notice a “burning” or “oily” smell the first few times you turn your oven on. This is normal in a new oven and will disappear in a short time. To speed the process, set a self-clean cycle for a minimum of 3 hours. See the Operating the Self-Cleaning Oven section.

Oven Light—Double Oven

Both lights come on when the upper oven door is opened or when the control panel light switch is turned on.

NOTE: The bottom oven does not have its own light switch. It operates by opening the upper oven door or by using the control panel light switch.

Oven Light—Single Oven

The light comes on when the oven door is opened or when the control panel switch is turned on.



Oven Shelves

The shelves are designed with stop-locks so when placed correctly on the shelf supports, they will stop before coming completely out of the oven and will not tilt when you are removing food from them or placing food on them.

When placing cookware on a shelf, pull the shelf out to the bump on the shelf support. Place the cookware on the shelf, then slide the shelf back into the oven. This will eliminate reaching into the hot oven.

To remove a shelf from the oven, pull the shelf toward you, tilt the front end upward and pull the shelf out.

To replace, place the shelf on the shelf support with the stop-locks (curved extension of shelf) facing up and toward the rear of the oven. Tilt up the front and push the shelf toward the back of the oven until it goes past the bump on the shelf support. Then lower the front of the shelf and push it all the way back.

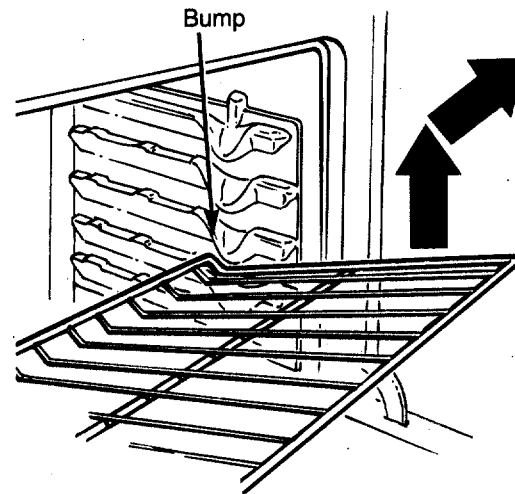

Shelf Positions

The oven has four shelf supports identified in this illustration as A (bottom), B, C and D (top).

Shelf positions for cooking are suggested in the Baking, Roasting and Broiling sections.

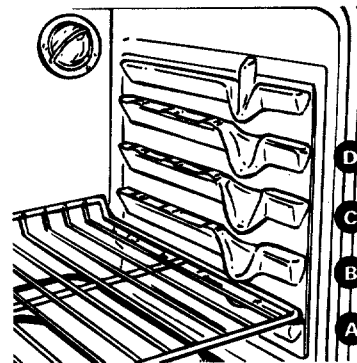

Automatic Oven Shut Off

As a safety feature, the single oven and the upper oven of double oven models will automatically shut itself off if it has been left on for more than 12 hours.

On double ovens, only the top oven has this feature.

Oven Vent

When the oven is on, heated air moves through a vent above the door or between door and air grille.

The vent area could get hot during oven use.

The vent is needed for proper air flow in the oven and good baking results. Do not block this vent.



BAKING

Your oven temperature is controlled very accurately using an oven control system. It is recommended that you operate the oven for a number of weeks to become familiar with your new oven's performance.

If you think an adjustment is necessary, see the Adjust the Oven Thermostat section. It gives easy *Do It Yourself* instructions on how to adjust the thermostat.

NOTE: When the oven gets hot, the top and outside surfaces of the oven get hot too.

How to Set the Oven for Baking

Ovens Controlled with Touch Pads

To avoid possible burns, place shelves in the correct position before you turn the oven on.

1. Press the **BAKE** pad.
2. Press the **INCREASE** or **DECREASE** pad until the desired temperature is displayed.

The word "ON" and "100°" will be displayed. As the oven heats up, the display will show the changing temperature. When the oven reaches the temperature you set, a tone will sound.

3. Press the **CLEAR/OFF** pad when baking is finished and then remove the food from the oven.

NOTE: A fan may automatically turn on and off to cool internal parts. This is normal, and the fan may continue to run after the oven is turned off.

To change the oven temperature during **BAKE** cycle, press the **BAKE** pad and then the **INCREASE** or **DECREASE** pad to get the new temperature.

Ovens Controlled with Knobs (on some models)

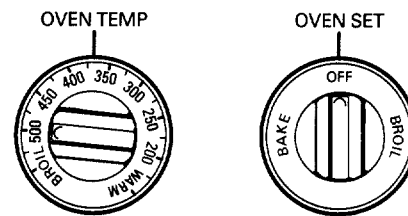

To avoid possible burns, place shelves in the correct position before you turn the oven on.

The **LOWER OVEN CONTROL** knobs are located on the left side of the control panel.

The lower oven can be used while the upper oven is on. The lower oven has a standard porcelain finish. See the Care and Cleaning section of this guide.

TO BAKE OR ROAST:

1. Turn the **OVEN SET** knob to **BAKE**.
2. Turn the **OVEN TEMP** knob to desired temperature.
3. When finished, turn the **OVEN SET** knob to **OFF**.

TO BROIL:

1. Turn both the **OVEN SET** and **OVEN TEMP** knob to **BROIL**.
2. When finished, turn the **OVEN SET** knob to **OFF**.

Oven Shelves

Arrange the oven shelf or shelves in the desired locations while the oven is cool. The correct shelf position depends on the kind of food and the browning desired. As a general rule, place most foods in the middle of the oven, on either shelf positions B or C. See the chart for suggested shelf positions.

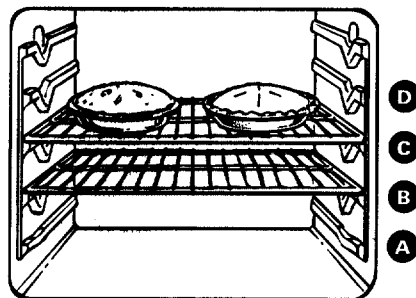

Type of Food	Shelf Position
Angel food cake	A
Biscuits or muffins	B or C
Cookies or cupcakes	B or C
Brownies	B or C
Layer cakes	B or C
Bundt or pound cakes	A or B
Pies or pie shells	B or C
Frozen pies	A (on cookie sheet)
Casseroles	B or C
Roasting	A or B

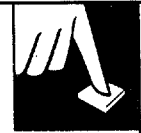

Preheating

Preheat the oven if the recipe calls for it. Preheat means bringing the oven up to the specified temperature before putting the food in the oven. To preheat, set the oven at the correct temperature—selecting a higher temperature does not shorten preheat time.

Preheating is necessary for good results when baking cakes, cookies, pastry and breads. For most casseroles and roasts, preheating is not necessary. For ovens without a preheat indicator light or tone, preheat 10 minutes. After the oven is preheated, place the food in the oven as quickly as possible to prevent heat from escaping.

Baking Pans

Use the proper baking pan. The type of finish on the pan determines the amount of browning that will occur.

- Dark, rough or dull pans absorb heat resulting in a browner, crisper crust. Use this type for pies.
- Shiny, bright and smooth pans reflect heat, resulting in a lighter, more delicate browning. Cakes and cookies require this type of pan.
- Glass baking dishes absorb heat. When baking in glass baking dishes, the temperature may need to be reduced by 25°F.

Pan Placement

For even cooking and proper browning, there must be enough room for air circulation in the oven. Baking results will be better if baking pans are centered as much as possible rather than being placed to the front or to the back of the oven.

Pans should not touch each other or the walls of the oven. Allow 1- to 1½-inch space between pans as well as from the back of the oven, the door and the sides. If you need to use two shelves, stagger the pans so one is not directly above the other.

Baking Guides

When using prepared baking mixes, follow package recipe or instructions for the best baking results.

Cookies

When baking cookies, flat cookie sheets (without sides) produce better-looking cookies. Cookies baked in a jelly roll pan (short sides all around) may have darker edges and pale or light browning may occur.

Do not use a cookie sheet so large that it touches the walls or the door of the oven. Never entirely cover a shelf with a large cookie sheet.

For best results, use only one cookie sheet in the oven at a time.

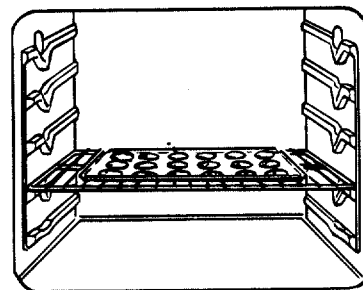

Pies

For best results, bake pies in dark, rough or dull pans to produce a browner, crisper crust. Frozen pies in foil pans should be placed on an aluminum cookie sheet for baking since the shiny foil pan reflects heat away from the pie crust; the cookie sheet helps retain it.

Cakes

When baking cakes, warped or bent pans will cause uneven baking results and poorly shaped products. A cake baked in a pan larger than the recipe recommends will usually be crisper, thinner and drier than it should be. If baked in a pan smaller than recommended, it may be undercooked and batter may overflow. Check the recipe to make sure the pan size used is the one recommended.

(continued next page)



BAKING

(continued)

Aluminum Foil

Never entirely cover a shelf with aluminum foil. This will disturb the heat circulation and result in poor baking. A smaller sheet of foil may be used to catch a spillover by placing it on a lower shelf several inches below the food.

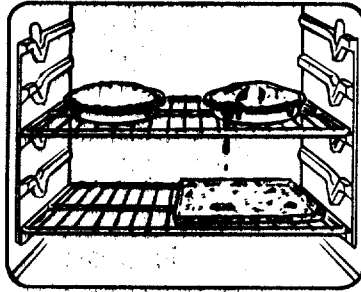

Don't Peek

Set the timer for the estimated cooking time and do not open the door to look at your food. Most recipes provide minimum and maximum baking times such as "bake 30-40 minutes."

DO NOT open the door to check until the minimum time. Opening the oven door frequently during cooking allows heat to escape and makes baking times longer. Your baking results may also be affected.

TIMED BAKING

(Ovens Controlled with Touch Pads)

How to Time Bake

The oven control allows you to turn the oven on or off automatically at specific times that you set.

Examples of **Immediate Start** (oven turns on now and you set it to turn off automatically) and **Delay Start and Stop** (setting the oven to turn on automatically at a later time and turn off at a preset **Stop Time**) will be described.

NOTE: Before beginning make sure the clock shows the correct time of day.

To set the clock, first press the **CLOCK** pad. Press the **INCREASE** or **DECREASE** pad until the correct time of day is displayed.

How to Set Immediate Start and Automatic Stop

To avoid possible burns, place the shelves in the correct position before you turn the oven on.

The oven will turn on immediately and cook for a selected length of time. At the end of Cook Time, the oven will turn off automatically.



1. Press the **COOK TIME** pad.

NOTE: If your recipe requires preheating, you may need to add additional time to the length of the Cook Time.

2. Press the **INCREASE** pad until the desired length of baking time appears in the display.



3. Press the **BAKE** pad.

4. Press the **INCREASE** or **DECREASE** pad until the desired temperature is displayed. An attention tone will sound if step 3 is not done.

The words "TIME BAKE" and "COOK TIME" will be displayed along with the oven temperature that you set and the Cook Time that you entered.

The oven will start automatically. The word "ON" and "100°" will be displayed. The Cook Time will begin to count down. As the oven heats up, the display will show the changing temperature. When the oven reaches the temperature you set, a tone will sound. The oven will continue to cook for the programmed amount of time, then shut off automatically.

5. Press the **CLEAR/OFF** pad to clear the display if necessary. Remove the food from the oven. Remember, even though the oven shuts off automatically, foods continue cooking after the controls are off.

NOTE:

- Foods that spoil easily, such as milk, eggs, fish, stuffings, poultry and pork, should not be allowed to sit for more than one hour before or after cooking. Room temperature promotes the growth of harmful bacteria. Be sure that the oven light is off because heat from the bulb will speed harmful bacteria growth.
- A fan may automatically turn on and off to cool internal parts. This is normal, and the fan may continue to run after the oven is turned off.

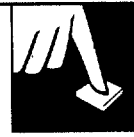

How to Set Delay Start and Automatic Stop

Quick Reminder:

1. Press the COOK TIME pad.
2. Press the INCREASE/DECREASE pad to set the length of cooking time.
3. Press the STOP TIME pad.
4. Press the INCREASE/DECREASE pad until the desired Stop Time appears in the display.
5. Press the BAKE pad.
6. Press the INCREASE/DECREASE pad to select an oven temperature.

To avoid possible burns, place the shelves in the correct position before you turn the oven on.

You can set the oven control to delay-start the oven, cook for a specific length of time and then turn off automatically.



1. Press the COOK TIME pad.

NOTE: If your recipe requires preheating, you may need to add additional time to the Cook Time.

2. Press the INCREASE pad until the desired length of cooking time appears in the display.



3. Press the STOP TIME pad. "STOP TIME" and the earliest Stop Time you can set appear in the display.

The control automatically sets the Stop Time by adding the Cook Time to the time of day. For example, the time of day is 2:00 and the Cook Time is 3 hours. Adding 3 hours to the time of day equals 5:00.

4. Change the Stop Time by pressing the INCREASE pad until the desired Stop Time appears in the display.



5. Press the BAKE pad.



6. Press the INCREASE or DECREASE pad until the desired temperature is displayed.



The oven will turn on automatically. The word "ON" and "100°" will be displayed. The Cook Time will begin to count down. As the oven heats up, the display will show the changing temperature. The oven will continue to cook for the programmed time and shut off automatically.

At the end of Timed Bake, the display will show "0HR:00 COOK TIME" and the oven will turn off. The end of cycle tone will sound.



7. Press the CLEAR/OFF pad to clear the display if necessary. Remove the food from the oven. Remember, even though the oven shuts off automatically, foods continue cooking after the controls are off.

NOTE:

- The low temperature zone of this oven (between 150°F. and 200°F.) is available to keep hot cooked foods warm. Foods kept in the oven longer than two hours at these low temperatures may spoil.
- Foods that spoil easily, such as milk, eggs, fish, stuffings, poultry and pork, should not be allowed to sit for more than one hour before or after cooking. Room temperature promotes the growth of harmful bacteria. Be sure the oven light is off because heat from the bulb will speed harmful bacteria growth.
- A fan may automatically turn on and off to cool internal parts. This is normal, and the fan may continue to run after the oven is turned off.



ADJUST THE OVEN THERMOSTAT— DO IT YOURSELF!

You may find that your new oven cooks differently than the one it replaced. We recommend that you use your new oven for a few weeks to become more familiar with it, following the times given in your recipes as a guide.

If you think your new oven is too hot or too cool, you can adjust the thermostat yourself. If you think it is too hot, adjust the thermostat to make it cooler. If you think it is too cool, adjust the thermostat to make it hotter.

We do not recommend the use of inexpensive thermometers, such as those found in grocery stores, to check the temperature setting of your new oven. These thermometers may vary 20–40 degrees.

Ovens Controlled with Touch Pads

To Adjust the Thermostat:

1. Press the BAKE pad.
2. Select an oven temperature between 500°F. and 550°F.
3. Immediately, before ON is displayed, press and hold the BAKE pad for about four seconds. The display will change to the oven adjustment display.

4. The oven temperature can be adjusted up to (+) 35°F. hotter or (-) 35°F. cooler. Use the INCREASE or DECREASE pad to select the desired change in the display.

5. When you have made the adjustment, press the CLEAR/OFF pad to go back to the time of day display. Use your oven as you would normally.

NOTE: This adjustment will not affect the broiling or self-cleaning temperatures. It will be retained in memory after a power failure.

Ovens Controlled with Knobs

Pull the knob off the shaft, look at the back of the knob and note the current setting before making any adjustment. The knob is factory set with the top screw directly under the pointer.

Back of the OVEN TEMP knob

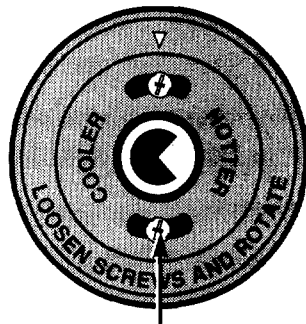

Lower screw moves toward HOTTER or COOLER

To Adjust the Thermostat:

1. Pull off the knob.
2. Loosen both screws on back of the knob.

3. Hold both parts of the knob as shown in the illustration of the back of the OVEN TEMP knob and turn so the lower screw moves in the desired direction. You will hear and feel the notches as you turn the knob. Each notch changes temperature about 10° Fahrenheit.

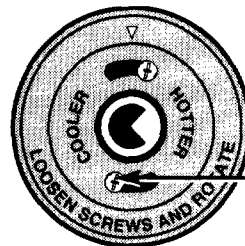
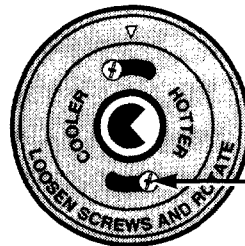

4. Tighten the screws.

5. Return the knob to the oven.

Re-check oven performance before making any additional adjustments.

ROASTING



Roasting is cooking by dry heat. Tender meat or poultry can be roasted uncovered in your oven. Roasting temperatures, which should be low and steady, keep spattering to a minimum.

Roasting is really a baking procedure used for meats. Therefore, oven controls are set for Baking or Timed Baking. (You may hear a slight clicking sound, indicating the oven is working properly.) Timed Baking will turn the oven on and off automatically.

Most meats continue to cook slightly while standing, after being removed from the oven. The standing time recommended for roasts is 10 to 20 minutes. This allows roasts to firm up and makes them easier to carve. The internal temperature will rise about 5° to 10°F.; to compensate for the temperature rise, if desired, remove the roast from oven sooner (at 5° to 10°F. less than temperature in the Roasting Guide).

Remember that food will continue to cook in the hot oven and therefore should be removed when the desired internal temperature has been reached.

Ovens Controlled with Touch Pads

1. Place the shelf in A or B position. No preheating is necessary.

2. Check the weight of the meat. Place it fat side up (or for poultry breast-side-up) on roasting rack in a shallow pan. The melting fat will baste the meat. Select a pan as close to the size of the meat as possible. (The broiler pan with rack is a good pan for this.)

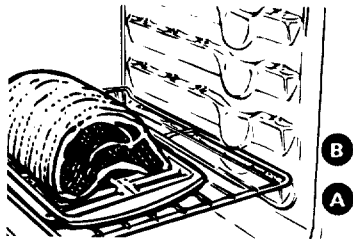

3. Press the BAKE pad.



4. Press the INCREASE or DECREASE pad until the desired temperature is displayed.



The oven will start automatically. The word "ON" and "100°" will be displayed. As the oven heats up, the display will show the changing temperature. When the oven reaches the temperature you set, a tone will sound.



5. Press the CLEAR/OFF pad when roasting is finished and then remove the food from the oven.

NOTE: A fan may automatically turn on and off to cool internal parts. This is normal, and the fan may continue to run after the oven is turned off.

To change the oven temperature during the roasting cycle, press the BAKE pad and then the INCREASE or DECREASE pad to get the new temperature.

Use of Aluminum Foil

You can use aluminum foil to line the broiler pan. This makes clean-up easier when using the pan for marinating, cooking with fruits, cooking heavily cured meats or basting food during cooking. Press the foil tightly around the inside of the pan.

(continued next page)

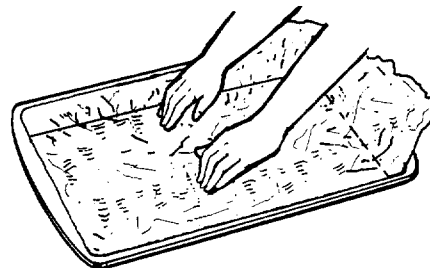



ROASTING

(continued)

Questions and Answers

Q. Is it necessary to check for doneness with a meat thermometer?

A. Checking the finished internal temperature at the completion of cooking time is recommended. Temperatures are shown in the Roasting Guide. For roasts over 8 pounds, check with thermometer at half-hour intervals after half the cooking time has passed.

Q. Why is my roast crumbling when I try to carve it?

A. Roasts are easier to slice if allowed to cool 10 to 20 minutes after removing them from the oven. Be sure to cut across the grain of the meat.

Q. Do I need to preheat my oven each time I cook a roast or poultry?

A. It is not necessary to preheat your oven.

Q. When buying a roast, are there any special tips that would help me cook it more evenly?

A. Yes. Buy a roast as even in thickness as possible, or buy rolled roasts.

Q. Can I seal the sides of my foil "tent" when roasting a turkey?

A. Sealing the foil will steam the meat. Leaving it unsealed allows the air to circulate and brown the meat.

ROASTING GUIDE

Frozen Roasts

Frozen roasts of beef, pork, lamb, etc., can be started without thawing, but allow 10 to 25 minutes per pound additional time (10 minutes per pound for roasts under 5 pounds, more time for larger roasts).

Make sure poultry is thawed before roasting. Unthawed poultry often does not cook evenly. Some commercial frozen poultry can be cooked successfully without thawing. Follow the directions given on the package label.

Type	Oven Temperature	Doneness	Approximate Roasting Time in Minutes per Pound		Internal Temperature °F.
Meat			3 to 5 lbs.	6 to 8 lbs.	
Tender cuts; rib, high quality sirloin tip, rump or top round*	325°	Rare: Medium: Well Done:	24-33 35-39 40-45	18-22 22-29 30-35	140°-150°† 150°-160° 170°-185°
Lamb leg or bone-in shoulder*	325°	Rare: Medium: Well Done:	21-25 25-30 30-35	20-23 24-28 28-33	140°-150°† 150°-160° 170°-185°
Veal shoulder, leg or loin*	325°	Well Done:	35-45	30-40	170°-180°
Pork loin, rib or shoulder*	325°	Well Done:	35-45	30-40	170°-180°
Ham, precooked	325°	To Warm:	17-20 minutes per pound (any weight)		115°-120°
Poultry			3 to 5 lbs.	Over 5 lbs.	
Chicken or Duck	325°	Well Done:	35-40	30-35	185°-190°
Chicken pieces	350°	Well Done:	35-40		185°-190°
Turkey	325°	Well Done:	10 to 15 lbs. 18-25	Over 15 lbs. 15-20	In thigh: 185°-190°

*For boneless rolled roasts over 6 inches thick, add 5 to 10 minutes per pound to times given above.

†The U. S. Department of Agriculture says "Rare beef is popular, but you should know that cooking it to only 140°F. means some food poisoning organisms may survive." (Source: Safe Food Book. Your Kitchen Guide. USDA Rev. June 1985.)

BROILING

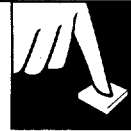

Broiling is cooking food by intense radiant heat from the upper broil element in the oven. Most fish and tender cuts of meat can be broiled. Follow these directions to keep spattering and smoking to a minimum.

1. If the meat has fat or gristle around the edge, cut vertical slashes through both about 2 inches apart. If desired, the fat may be trimmed, leaving a layer about 1/8 inch thick.
2. Place the meat on the broiler rack in the broiler pan. Always use the rack so the fat drips into the broiler pan; otherwise the juices may become hot enough to catch on fire.
3. Position a flat shelf on recommended shelf position as suggested in the Broiling Guide. Most broiling is done on C position, **but if your oven is connected to 208 volts, you may wish to use a higher position.**

4. Leave the door open to the broil stop position.

The door stays open by itself, yet the proper temperature is maintained in the oven.

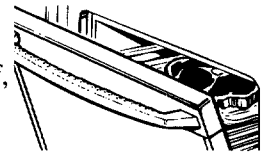

5. Turn the food only once during broiling.

Time the foods for the first side according to the Broiling Guide. Turn the food, then use the times given for the second side as a guide to the preferred doneness.

NOTE: A fan may automatically turn on and off to cool internal parts. This is normal, and the fan may continue to run after the oven is turned off.

Ovens Controlled with Touch Pads



1. Press the BROIL pad.

2. Press the INCREASE pad once for LO Broil or twice for HI Broil. To change from HI Broil to LO Broil, press the BROIL pad then press the DECREASE pad once.
3. When broiling is finished, press the CLEAR/OFF pad. Serve the food immediately, and leave the pan outside the oven to cool during the meal for easiest cleaning.

Use of Aluminum Foil

You can use aluminum foil to line your broiler pan and broiler rack.

However, you must mold the foil tightly to the rack and cut slits in it just like the rack.

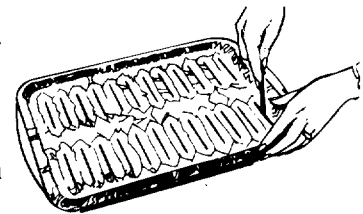

Without the slits, the foil will prevent fat and meat juices from draining to the broiler pan. The juices could become hot enough to catch on fire. If you do not cut the slits, you are frying, not broiling.

Questions and Answers

Q. Why are my meats not turning out as brown as they should?

- A. In some areas, the power (voltage) to the oven may be low. In these cases, preheat the broil element for 10 minutes before placing broiler pan with food in the oven. Check to see if you are using the recommended shelf position. Broil for the longest period of time indicated in the Broiling Guide. Turn the food only once during broiling. You may need to move the food to a higher shelf position.

Q. When broiling, is it necessary to always use a rack in the pan?

- A. Yes. Using the rack suspends the meat over the pan. As the meat cooks, the juices fall into the pan, thus keeping the meat drier. Juices are protected by the rack and stay cooler, thus preventing excessive spatter and smoking.

Q. Should I salt the meat before broiling?

- A. No. Salt draws out the juices and allows them to evaporate. Always salt after cooking. Turn the meat with tongs; piercing the meat with a fork also allows the juices to escape. When broiling poultry or fish, brush each side often with butter.

Q. Do I need to grease my broiler rack to prevent meat from sticking?

- A. No. The broiler rack is designed to reflect broiler heat, thus keeping the surface cool enough to prevent meat from sticking to the surface. However, spraying the broiler rack lightly with a vegetable cooking spray before cooking will make clean-up easier.

(continued next page)



BROILING GUIDE

- Always use the broiler pan and rack that comes with your oven. It is designed to minimize smoking and spattering by trapping the juices in the shielded lower part of the pan.
- **The oven door should be open to the broil stop position.**
- For steaks and chops, slash fat evenly around the outside edges of the meat. To slash, cut crosswise through the outer fat surface just to the edge of the meat. Use tongs to turn the meat over to prevent piercing the meat and losing the juices.
- If desired, marinate meats or chicken before broiling, or brush with barbecue sauce last 5 to 10 minutes only.
- When arranging food on the pan, do not let fatty edges hang over the sides because the dripping fat will soil the oven.
- The broiler does not need to be preheated. However, for very thin foods, or to increase browning, preheat if desired.
- Use LO Broil to cook foods such as poultry or thick pork chops thoroughly without over-browning them.
- Frozen steaks can be broiled by positioning the oven shelf at next lowest shelf position and increasing cooking time given in this guide 1½ times per side.
- **If your oven is connected to 208 volts**, rare steaks may be broiled by preheating the broiler and positioning the oven shelf one position higher.

Food	Quantity and/or Thickness	Shelf Position	First Side Time, Minutes	Second Side Time, Minutes	Comments
Bacon	1/2 lb. (about 8 thin slices)	C	4½	4½	Arrange in single layer.
Ground Beef Well Done	1 lb. (4 patties) 1/2 to 3/4 inch thick	C	10	7	Space evenly. Up to 8 patties take about same time.
Beef Steaks					
Rare	1 inch thick	C	6	5	Steaks less than 1 inch thick cook through before browning. Pan frying is recommended.
Medium	(1 to 1½ lbs.)	C	8	6	
Well Done		C	12	11	
Rare	1½ inch thick	C	10	7-8	Slash fat.
Medium	(2 to 2½ lbs.)	C	15	14-16	
Well Done		C	25	20-25	
Chicken	1 whole (2 to 2½ lbs.), split lengthwise	A	35	10-15	Reduce time about 5 to 10 minutes per side for cut-up chicken. Brush each side with melted butter. Broil skin-side-down first.
Bakery Products					
Bread (Toast) or Toaster Pastries	2 to 4 slices	C or D	1½-2	1/2	Space evenly. Place English muffins cut-side-up and brush with butter, if desired.
English Muffins	1 pkg. (2) 2 (split)	C or D	3-4		
Lobster Tails	2-4 (6 to 8 oz. each)	B	13-16	Do not turn over.	Cut through back of shell. Spread open. Brush with melted butter before broiling and after half of broiling time.
Fish	1-lb. fillets 1/4 to 1/2 inch thick	C	5	5	Handle and turn very carefully. Brush with lemon butter before and during cooking, if desired. Preheat broiler to increase browning.
Ham Slices (precooked)	1 inch thick	B	8	8	Increase time 5 to 10 minutes per side for 1½ inch thick or home cured ham.
Pork Chops Well Done	2 (1/2 inch thick) 2 (1 inch thick), about 1 lb.	C B	10 13	10 13	Slash fat.
Lamb Chops					
Medium	2 (1 inch thick), about 10 to 12 oz.	C	10	9	Slash fat.
Well Done		C	12	10	
Medium	2 (1½ inch thick), about 1 lb.	C	14	12	
Well Done		B	17	12-14	
Wieners and similar precooked sausages, bratwurst	1-lb. pkg. (10)	C	6	1-2	If desired, split sausages in half lengthwise; cut into 5- to 6-inch pieces.

OPERATING THE SELF-CLEANING OVEN

Normal Cleaning Time: 3 hours



In models with double ovens, only the upper oven is self-cleaning. The bottom oven is standard clean. See the Porcelain Oven Interior section. Single oven models are self-cleaning.

Before a Clean Cycle

We recommend venting with an open window or using a ventilation fan or hood during the first self-cleaning cycle.

1. Remove the broiler pan, broiler rack, all cookware and any aluminum foil from the oven—they can't withstand the high cleaning temperatures.

NOTE: The oven shelves may be cleaned in the self-cleaning oven. However, they will darken, lose their luster and become hard to slide.

2. Wipe up heavy soil on the oven bottom. If you use soap, **rinse thoroughly before self-cleaning to prevent staining.**

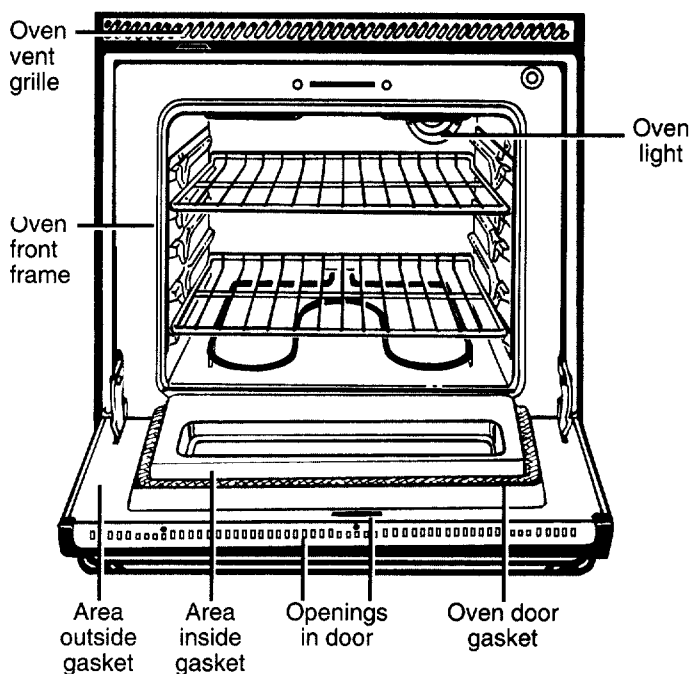

3. Clean spatters or soil on the oven front frame and the oven door outside the gasket with a dampened cloth. The oven front frame and the oven door outside the gasket do not get cleaned by the self-clean cycle. On these areas, use detergent and hot water or a soap-filled steel wool pad. Rinse well with a vinegar and water solution. This will help prevent a brown residue from forming when the oven is heated. Buff these areas with a dry cloth. Do not clean the gasket.

Do not use abrasives or oven cleaners. Clean the outside front of the oven door with soap and water. Also use soap and water to clean under the oven vent grille.

Make sure the oven light bulb cover is in place.

Do not rub or clean the door gasket—the fiberglass material of the gasket has an extremely low resistance to abrasion. An intact and well-fitting oven door gasket is essential for energy-efficient oven operation and good baking results. If you notice the gasket becoming worn, frayed or damaged in any way or if it has become displaced on the door, you should have it replaced.

Do not let water run down through openings in the top of the door. To help prevent water from getting in these slots when cleaning, open the door as far as it will go.

4. Close the oven door and make sure the oven light is off. If the oven light is not turned off, the life of the bulb will be shortened or it may burn out immediately. The door latches automatically after the clean cycle is set.

Do not use commercial oven cleaners or oven protectors in or near the self-cleaning oven. A combination of any of these products plus the high clean-cycle temperature may damage the porcelain finish of the oven.

(continued next page)



OPERATING THE SELF-CLEANING OVEN

(continued)

How to Set Oven for Cleaning

Quick Reminder:

1. Press the AUTO SELF CLEAN pad.
2. Press the INCREASE or DECREASE pad until the desired Clean Time appears.

If the oven is too hot and you start to set a clean cycle, the word "OFF" will appear in the display. Allow additional time for cooling before you try to set the cycle.

1. Follow the directions in the Before a Clean Cycle section.



2. After closing the door, press the AUTO SELF CLEAN pad.



3. Press the INCREASE or DECREASE pad until the desired Clean Time is displayed.



Clean Time is normally 3 hours. You can change the Clean Time to anytime between 2 and 4 hours, depending on the amount of soil in your oven.

The self-clean cycle will automatically begin after "CLEAN" is displayed and the time for the clean cycle is set. The words "ON" and "LOCK" will appear in the display when the door automatically locks. It will not be possible to open the oven door until the temperature drops below the lock temperature and the LOCK light goes off.

4. When the LOCK light is off, open the door.

NOTE:



- You can find out when the clean cycle will be finished by pressing the STOP TIME pad.

- The word "door" will be displayed, the word "LOCK" will flash and oven control will signal if you set the clean cycle and forget to close the oven door.
- A fan may automatically turn on and off to cool internal parts. This is normal, and the fan may continue to run after the oven is turned off.

To Stop a Clean Cycle



1. Press the CLEAR/OFF pad.

2. When the LOCK light goes off and the oven has cooled below the locking temperature, open the door.



After Self-Cleaning

You may notice some white ash in the oven. Just wipe it up with a damp cloth after the oven cools.

If white spots remain, remove them with a soap-filled steel wool pad. Be sure to rinse thoroughly with a vinegar and water mixture. These deposits are usually a salt residue that cannot be removed by the clean cycle.

If the oven is not clean after one clean cycle, repeat the cycle.

If the shelves have become hard to slide, wipe the shelf supports with cooking oil.

NOTE: No functions can be programmed before the door automatically unlocks.

How to Set Delay Start of Cleaning

Quick Reminder:

1. Press the AUTO SELF CLEAN pad.
2. Press the INCREASE or DECREASE pad until the desired Clean Time appears.
3. Press the STOP TIME pad.
4. Press the INCREASE or DECREASE pad until the desired Stop Time appears in the display.

Delay Start is setting the oven timer to start the clean cycle automatically at a later time than the present time of day.

NOTE: Before beginning, make sure the oven clock shows the correct time of day.

1. Follow the directions in the Before a Clean Cycle section.



2. After closing the door, press the AUTO SELF CLEAN pad.



3. Press the INCREASE or DECREASE pad to enter the Clean Time.



4. Press the STOP TIME pad. "STOP TIME" and the earliest Stop Time you can set will appear in the display.

The earliest Stop Time will be the Clean Time selected plus the time of day. **For example:** If the Clean Time is three hours and the time of day is 6:00, the Stop Time that appears in the display will be 9:00.



5. Press the INCREASE pad to change the Stop Time to a later time of day if desired. For example: If you set Stop Time at 11:00, oven will start clean cycle at 8:00 and end at 11:00. The door latches automatically.

The self-clean cycle will automatically begin after "CLEAN" is displayed and the time for clean cycle is set. The words "ON" and "LOCK" will appear in the display when the door automatically locks. It will not be possible to open the oven door until the temperature drops below the lock temperature and the LOCK light goes off.

6. When the LOCK light is off, open the door.

NOTE:

- During a delayed self-clean operation you can find out when the oven is set to turn on by pressing and holding the AUTO SELF CLEAN pad for 3 seconds.
- A fan may automatically turn on and off to cool internal parts. This is normal, and the fan may continue to run after the oven is turned off.

(continued next page)



OPERATING THE SELF-CLEANING OVEN

(continued)

Questions and Answers

- Q. If my oven clock is not set to the correct time of day, can I still self-clean my oven?**
- A. If the clock is not set to the correct time of day you will not be able to set a delay clean to end at a specific time.
- Q. Can I use commercial oven cleaners on any part of my self-cleaning oven?**
- A. No cleaners or coatings should be used around any part of this oven. If you do use them and do not thoroughly rinse the oven with water, wiping it absolutely clean afterward, the residue can scar the oven surface and damage metal parts the next time the oven is automatically cleaned.
- Q. What should I do if excessive smoking occurs during cleaning?**
- A. This is caused by excessive soil. Turn the oven off. Open the windows to rid the room of smoke. Wait until the oven has cooled and the word "LOCK" is off in the display. Wipe up the excess soil and reset the clean cycle.
- Q. Is the "crackling" or "popping" sound I hear during cleaning normal?**
- A. Yes. This is the sound of the metal heating and cooling during both the cooking and cleaning functions.
- Q. Should there be any odor during the cleaning?**
- A. Yes, there will be an odor during the first few cleanings. Failure to wipe out excessive soil might also cause a strong odor when cleaning.
- Q. What causes the hair-like lines on the enameled surface of my oven?**
- A. This is a normal condition, resulting from heating and cooling during cleaning. These lines do not affect how your oven performs.
- Q. Why do I have ash left in my oven after cleaning?**
- A. Some types of soil will leave a deposit which is ash. It can be removed with a damp sponge or cloth.
- Q. My oven shelves do not slide easily. What is the matter?**
- A. After many cleanings, the oven shelves will lose their luster and become hard to slide. To make the shelves slide more easily, wipe the shelf supports with cooking oil.
- Q. My oven shelves have become gray after the self-clean cycle. Is this normal?**
- A. Yes. After the self-clean cycle, the shelves will lose some luster and discolor to a deep gray color.



CARE AND CLEANING

Proper care and cleaning are important so your oven will give you efficient and satisfactory service. Follow these directions carefully in caring for your oven to assure safe and proper maintenance.

BE SURE ELECTRICAL POWER IS OFF BEFORE CLEANING ANY PART OF THE OVEN.

Oven Heating Elements

Do not clean the bake element or the broil element. Any soil will burn off when the elements are heated.

The bake element can be lifted gently to clean the oven floor. If spillovers, residue or ash accumulate around the bake element gently wipe around the element with warm water.

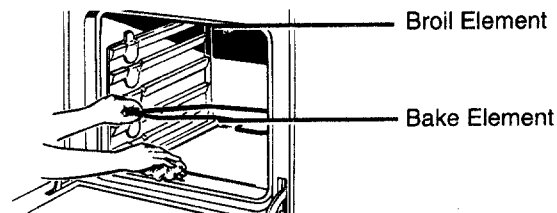

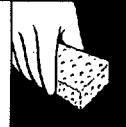

Oven Shelves

Clean the shelves with an abrasive cleanser or steel wool. After cleaning, rinse the shelves with clean water and dry with a clean cloth.

NOTE: The oven shelves may also be cleaned in the self-cleaning oven. However, the shelves will darken in color, lose their luster and become hard to slide if cleaned during the self-cleaning cycle. Wipe the shelf supports with cooking oil to make the shelves slide more easily.



Broiler Pan and Rack



After broiling, remove the broiler pan from the oven. Remove the rack from the pan. Carefully pour out grease from the pan into a proper container. Wash and rinse the broiler pan and rack in hot water with a soap-filled or plastic scouring pad.

If food has burned on, sprinkle the rack with detergent while hot and cover with wet paper towels or a dishcloth. Soaking the pan will remove burned on foods.

The broiler pan may be cleaned with a commercial oven cleaner. Do not use an oven cleaner on the rack.

Both the broiler pan and rack can also be cleaned in the dishwasher.

Do not clean the broiler pan or rack in the self-cleaning oven.

Do not store a soiled broiler pan and rack anywhere in the oven.

Oven Light Bulb Replacement

CAUTION: Before replacing your oven light, disconnect electrical power for your oven at the main fuse or circuit breaker panel or pull the plug. Be sure to let the light cover and bulb cool completely before removing or replacing them. When cleaning, avoid touching warm lights with cleaning cloths if the light cover is removed.

The oven light (bulb) is covered with a removable glass cover which is held in place with a wire. Remove the oven door, if desired, to reach cover easily.

To remove:

- Hold your hand under the cover so it doesn't fall when released. With fingers of the same hand, firmly push back the wire cover holder. Lift off the cover.

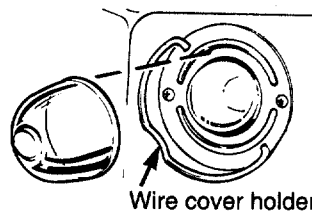

• DO NOT REMOVE ANY SCREWS.

- Replace bulb with 40-watt home appliance bulb.

To replace cover:

- Place it into the groove of the light receptacle. Pull wire forward to the center of cover until it snaps into place. When in place, the wire holds the cover firmly. Be certain the wire is in the depression in the center of the cover.
- Connect the electrical power to the oven.

(continued next page)



CARE AND CLEANING

(continued)

Lift-Off Oven Door (single oven or upper oven only)

The oven door is removable, but it is heavy. You may need help removing and replacing the door. Do not lift the door by the handle. This can cause the glass to break or can cause damage to the door.

To remove the door, open it a few inches to the special stop position that will hold the door open. Grasp firmly on each side and lift the door straight up and off the hinges.

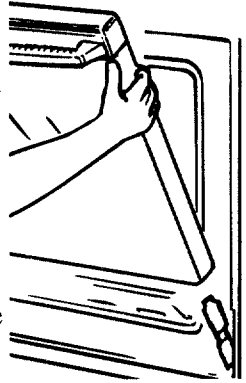

NOTE:

- Be careful not to place hands between the hinge and the oven door frame as the hinge could snap back and pinch fingers.
- While working in the oven area, cover the hinges with towels or empty paper towel rolls to prevent pinched fingers and chipping the porcelain enamel on the frame.

To replace the door, make sure the hinges are in the special stop position. Position the slots in the bottom of the door squarely over the hinges. Then lower the door slowly and evenly over both hinges at the same time. If hinges snap back against the oven frame, pull them back out.

TO CLEAN THE DOOR:

Inside of the door:

- Because the area inside the gasket is cleaned during the self clean cycle, you do not need to clean this by hand. Any soap left on the liner causes additional stains when the oven is heated.

- The area outside the gasket can be cleaned with a soap-filled scouring pad.
- Do not rub or clean the door gasket—the fiberglass material of the gasket has an extremely low resistance to abrasion. An intact and well-fitting oven door gasket is essential for energy-efficient oven operation and good baking results. If you notice the gasket becoming worn, frayed or damaged in any way or if it has become displaced on the door, you should have it replaced.

NOTE: The gasket is designed with a gap at the bottom to allow for proper air circulation.

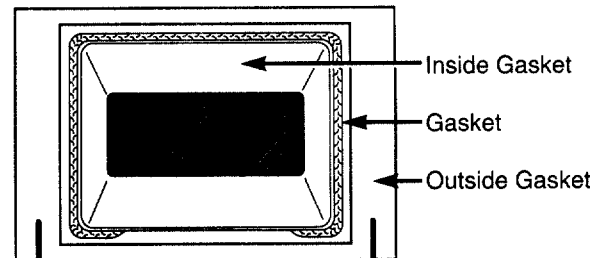

Outside of the door:

- Use soap and water to thoroughly clean the top, sides and front of the oven door. Rinse well. You may also use a glass cleaner to clean the glass on outside of the door.
- Spillage of marinades, fruit juices, tomato sauces and basting materials containing acids may cause discoloration and should be wiped up immediately. When surface is cool, clean and rinse.
- **Do not use oven cleaners, cleansing powders or harsh abrasives on the outside of the door.**

Lift-Off Oven Door (lower oven only—on some models)

Follow the same directions for removing and replacing the door as described above.

TO CLEAN THE DOOR:

Inside of door:

- **Soap and water will normally do the job.** Heavy spattering or spillovers may require cleaning with a mild abrasive cleaner. Soapy, wet metal pads may also be used. Do not allow food spills with a high sugar or acid content (such as milk, tomatoes, sauerkraut, fruit juices or pie filling) to remain on the surface. They may cause a dull spot even after cleaning.
- **If necessary, you may use an oven cleaner.** Follow the package directions.

- Clean the inside of the oven window with a mild non-scratching cleaner and a damp cloth.

Outside of door:

- Use soap and water to thoroughly clean the top, sides and front of the oven door. **DO NOT** let water run down through openings in the top of the door. Rinse well. You may also use a glass cleaner to clean the glass on the outside of the door.
- Spillage of marinades, fruit juices, tomato sauces and basting materials containing acids may cause discoloration and should be wiped up immediately. When surface is cool, clean and rinse.
- **Do not use oven cleaners, cleansing powders or harsh abrasives on the outside of the door.**

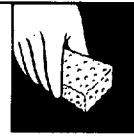

Porcelain Oven Interior (lower oven only—on some models)

With proper care, the porcelain enamel finish on the inside of the oven—top, bottom, sides, back and inside of the door—will stay new-looking for years.

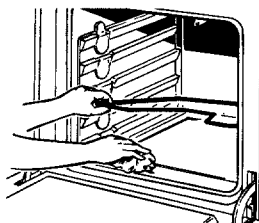

Let the oven cool before cleaning. We recommend that you wear rubber gloves when cleaning the oven.

Soap and water will normally do the job. Heavy spattering or spillovers may require cleaning with a mild abrasive cleaner. Soapy, wet metal pads may also be used. Do not allow food spills with a high sugar or acid content (such as milk, tomatoes, sauerkraut, fruit juices or pie filling) to remain on the surface. They may cause a dull spot even after cleaning.

Household ammonia may make the cleaning job easier. Place 1/2 cup in a shallow glass or pottery container in a cold oven overnight. The ammonia fumes will help loosen the burned-on grease and food.

If necessary, you may use an oven cleaner. Follow the package directions.

Cautions about using spray-on oven cleaners:

- **Do not** spray on the electrical controls and switches because it could cause a short circuit and result in sparking or fire.
- **Do not** allow a film from the cleaner to build up on the temperature sensor—it could cause the oven to heat improperly. (The sensor is located at the top of the oven.) Carefully wipe the sensor clean after each oven cleaning, being careful not to move the sensor as a change in its position could affect how the oven bakes.
- **Do not** spray any oven cleaner on the oven door, handles or any exterior surface of the oven, cabinets or painted surfaces. The cleaner can damage these surfaces.

Glass Window

To clean the outside of the oven window, use a glass cleaner. Rinse and polish with a dry cloth.

Do not allow the water or cleaner to run down inside the openings in the glass or the openings in the top of the oven door while cleaning.

Painted Surfaces

Painted surfaces include the outside of the oven door and the control panel. Clean these with soap and water or a vinegar and water solution. **Do not use commercial oven cleaners, cleansing powder, steel wool or harsh abrasives on any painted surface.**

Control Panel and Knobs

It's a good idea to wipe the control panel after each use. Clean with mild soap and water or vinegar and water, rinse with clean water and polish dry with a soft cloth.

Do not use abrasive cleansers, strong liquid cleansers, plastic scouring pads or oven cleansers on the control panel—they will damage the finish. A 50/50 solution of vinegar and hot water solution works well.

The control knobs (lower oven only—on some models) may be removed for easier cleaning.

Before removing the knobs for cleaning, please note that the knobs on the left side and the knobs on the right side are on the proper OFF position. When replacing the knobs, check the OFF position to insure proper placement.

The knob stem has a groove in each side. The groove on one side has a spring clip. The other groove is clear (see illustration). When removing the knob, it may be helpful to slip a thin cloth (such as a handkerchief) or a piece of string under and around the knob edge and pull up. Check the inside of the knob and find the molded rib.

Wash the knobs in soap and water or a vinegar and hot water solution but do not soak.

Replace the knob by fitting the molded rib inside the knob into the clear groove on the stem.

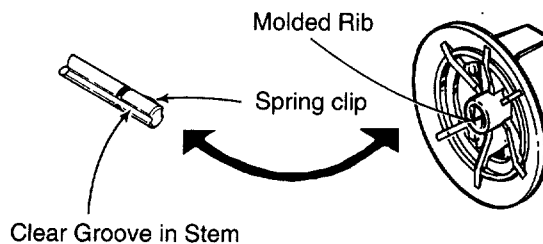



QUESTIONS? USE THIS PROBLEM SOLVER

PROBLEM	POSSIBLE CAUSE
"F- AND A NUMBER" FLASH IN THE DISPLAY	<ul style="list-style-type: none"> • This is function error code. Press the CLEAR/OFF pad. Allow the oven to cool one hour. Place the oven back into operation. If function error occurs again, disconnect power to the oven and call for service.
OVEN WILL NOT WORK	<ul style="list-style-type: none"> • The circuit breaker in your house has been tripped, or a fuse has been blown. • The oven controls are not properly set.
OVEN LIGHT DOES NOT WORK	<ul style="list-style-type: none"> • The light bulb is loose or defective. Tighten or replace. • The switch operating the oven light is broken. Call for service.
FOOD DOES NOT BROIL PROPERLY	<ul style="list-style-type: none"> • Oven controls not set properly. See the Broiling section. • Door not left open to the broil stop position as recommended. • Improper shelf position being used. See the Broiling Guide. • Food is being cooked on a hot pan. • Cookware is not suited for broiling. • Low voltage. See the Broiling section. • Aluminum foil used on the broiler pan and rack has not been fitted properly and slit as recommended.
FOOD DOES NOT ROAST OR BAKE PROPERLY	<ul style="list-style-type: none"> • Oven controls not set properly. See the Baking or Roasting section. • Shelf position is incorrect. See the Roasting or Baking section. • Incorrect cookware or cookware of improper size is being used. • Oven thermostat needs adjustment. See the Adjust the Oven Thermostat—<i>Do It Yourself</i> section.
CLOCK AND MINUTE/SECOND TIMER DO NOT WORK	<ul style="list-style-type: none"> • Check for a power outage. • See the Oven Control, Clock and Timer section.
OVEN WILL NOT SELF-CLEAN	<ul style="list-style-type: none"> • Oven temperature is too high to set self-clean operation. Allow the oven to cool to room temperature and reset the controls.
DOOR WILL NOT OPEN AFTER SELF-CLEAN CYCLE	<ul style="list-style-type: none"> • When the temperature has fallen below the locking temperature, the door can be opened.
CONTROL SIGNALS AFTER ENTERING COOK TIME OR STOP TIME	<ul style="list-style-type: none"> • This is reminding you to enter a bake temperature.
OVEN TEMPERATURE TOO HOT OR TOO COLD	<ul style="list-style-type: none"> • Oven thermostat needs adjustment. See the Adjust the Oven Thermostat—<i>Do It Yourself</i> section.
"BURNING" OR "OILY" ODOR EMITTING FROM OVEN WHEN TURNED ON	<ul style="list-style-type: none"> • This is normal in a new oven and will disappear in time. To speed the process, set a self-clean cycle for a minimum of 3 hours. See the Operating the Self-Cleaning Oven section.
STRONG ODOR	<ul style="list-style-type: none"> • An odor from the insulation around the inside of the oven is normal for the first few times the oven is used. This is temporary.
OVEN NOT CLEAN AFTER SELF-CLEAN CYCLE	<ul style="list-style-type: none"> • Oven controls not set properly. See the Operating the Self-Cleaning Oven section. • Heavily soiled ovens require 3½- to 4-hour Clean Time. • Heavy spillovers should be cleaned up before starting the self-cleaning cycle.
"door" APPEARS IN THE DISPLAY	<ul style="list-style-type: none"> • Oven door not closed after self-clean cycle is selected. • Door is still locked and you are trying to enter an oven cooking operation.
FAN NOISE	<ul style="list-style-type: none"> • A fan may automatically turn on and off to cool internal parts. This is normal, and the fan may continue to run after the oven is turned off.

**If you need more help...call, toll free:
GE Answer Center® 800.626.2000 consumer information service**

We'll Be There

With the purchase of your new GE appliance, receive the assurance that if you ever need information or assistance from GE, we'll be there. All you have to do is call—toll-free!

GE Answer Center[®] **800.626.2000**

Whatever your question about any GE major appliance, GE Answer Center[®] information service is available to help. Your call—and your question—will be answered promptly and courteously. And you can call any time. GE Answer Center[®] service is open 24 hours a day, 7 days a week.

In-Home Repair Service **800-GE-CARES (800-432-2737)**

A GE consumer service professional will provide expert repair service, scheduled at a time that's convenient for you. Many GE Consumer Service company-operated locations offer you service today or tomorrow, or at your convenience (7:00 a.m. to 7:00 p.m. weekdays, 9:00 a.m. to 2:00 p.m. Saturdays). Our factory-trained technicians know your appliance inside and out—so most repairs can be handled in just one visit.

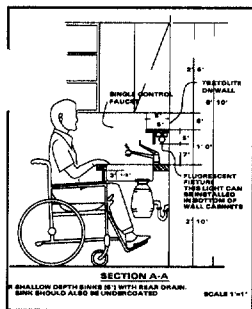

For Customers With Special Needs... **800.626.2000**

Upon request, GE will provide Braille controls for a variety of GE appliances, and a brochure to assist in planning a barrier-free kitchen for persons with limited mobility. To obtain these items, free of charge, call 800.626.2000.

Consumers with impaired hearing or speech who have access to a TDD or a conventional teletypewriter may call 800-TDD-GEAC (800-833-4322) to request information or service.

Service Contracts **800-626-2224**

You can have the secure feeling that GE Consumer Service will still be there after your warranty expires. Purchase a GE contract while your warranty is still in effect and you'll receive a substantial discount. With a multiple-year contract, you're assured of future service at today's prices.

Parts and Accessories **800-626-2002**

Individuals qualified to service their own appliances can have needed parts or accessories sent directly to their home. The GE parts system provides access to over 47,000 parts...and all GE Genuine Renewal Parts are fully warranted. VISA, MasterCard and Discover cards are accepted.

User maintenance instructions contained in this guide cover procedures intended to be performed by any user. Other servicing generally should be referred to qualified service personnel. Caution must be exercised, since improper servicing may cause unsafe operation.

YOUR GE BUILT-IN OVEN WARRANTY

Staple sales slip or cancelled check here. Proof of original purchase date is needed to obtain service under warranty.

WHAT IS COVERED

FULL ONE-YEAR WARRANTY

For one year from date of original purchase, we will provide, free of charge, parts and service labor in your home to repair or replace **any part of the oven** that fails because of a manufacturing defect.

This warranty is extended to the original purchaser and any succeeding owner for products purchased for ordinary home use in the 48 mainland states, Hawaii and Washington, D.C. In Alaska the warranty is the same except that it is LIMITED because you must pay to ship the product to the service shop or for the service technician's travel costs to your home.

All warranty service will be provided by our Factory Service Centers or by our authorized Customer Care[®] servicers during normal working hours.

Should your appliance need service, during warranty period or beyond, call 800-GE-CARES (800-432-2737).

WHAT IS NOT COVERED

- Service trips to your home to teach you how to use the product.

Read your Use and Care material. If you then have any questions about operating the product please contact your dealer or our Consumer Affairs office at the address below, or call, toll free:

GE Answer Center[®]
800.626.2000
consumer information service

- Improper installation.

If you have an installation problem, contact your dealer or installer. You are responsible for providing adequate electrical, gas, exhausting and other connecting facilities as described in the Installation Instructions provided with the product.

- Replacement of house fuses or resetting of circuit breakers.
- Failure of the product if it is used for other than its intended purpose or used commercially.
- Damage to product caused by accident, fire, floods or acts of God.

WARRANTOR IS NOT RESPONSIBLE FOR CONSEQUENTIAL DAMAGES.

Some states do not allow the exclusion or limitation of incidental or consequential damages, so the above limitation or exclusion may not apply to you. This warranty gives you specific legal rights, and you may also have other rights which vary from state to state. To know what your legal rights are in your state, consult your local or state consumer affairs office or your state's Attorney General.

Warrantor: General Electric Company

**If further help is needed concerning this warranty, write:
Manager—Consumer Affairs, GE Appliances, Louisville, KY 40225**



Recycled Paper

Part No. 164D2966P122

Pub No. 49-8601

1-95 CG

JKP13 JK,
JKP14 JRP14
JKP15 JRP15
JKP26 JRP24

Free Manuals Download Website

<http://myh66.com>

<http://usermanuals.us>

<http://www.somanuals.com>

<http://www.4manuals.cc>

<http://www.manual-lib.com>

<http://www.404manual.com>

<http://www.luxmanual.com>

<http://aubethermostatmanual.com>

Golf course search by state

<http://golfingnear.com>

Email search by domain

<http://emailbydomain.com>

Auto manuals search

<http://auto.somanuals.com>

TV manuals search

<http://tv.somanuals.com>