



Use and Care Guide

Built-In Gas Oven



Safety Instructions 2-4



Operating Instructions

Aluminum Foil..... 4, 14, 18-20, 24

Baking 12-14

Broiling 20, 21

Fan..... 11, 12

Features 5

Oven Control, Clock and Timer..... 6-10

Roasting 18, 19

Shelves 11, 13, 18, 22

Special Features of Your Control 8-10

Timed Baking..... 15, 16



Care and Cleaning

Broiler Drawer..... 23

Broiler Pan and Grid..... 23

Lift-Off Oven Door 23

Oven Light..... 22

Removable Oven Bottom..... 24

Shelves 22



Problem Solver

Thermostat Adjustment-
Do It Yourself..... 17

More questions?...call
GE Answer Center® 800.626.2000



Minor Adjustments

Broil and Oven Burner..... 24



Consumer Services

Important Phone Numbers..... 27

Model and Serial Numbers 2

Removal of Packaging Tape 2

Warranty Back Cover



HELP US HELP YOU...

Read this guide carefully.

It is intended to help you operate and maintain your new oven properly.

Keep it handy for answers to your questions.

If you don't understand something or need more help, call:

GE Answer Center®

800.626.2000

24 hours a day, 7 days a week

How to Remove Packaging Tape

To assure no damage is done to the finish of the product, the safest way to remove adhesive left from packaging tape on new appliances is an application of a household liquid dishwashing detergent, mineral oil or cooking oil. Apply with a soft cloth and allow to soak. Wipe dry and then apply an appliance polish to thoroughly clean and protect the surface.

NOTE: The plastic tape must be removed from the chrome trim on oven parts. It cannot be removed if it is baked on.

Write down the model and serial numbers.

You'll find them on a label on the front of the oven behind the door.

These numbers are also on the Consumer Product Ownership Registration Card that came with your oven. Before sending in this card, please write these numbers here:

Model Number

Serial Number

Use these numbers in any correspondence or service calls concerning your oven.

If you received a damaged oven...

Immediately contact the dealer (or builder) that sold you the oven.

Save time and money.

Before you request service...

Check the Problem Solver in the back of this guide. It lists causes of minor operating problems that you can correct yourself.

IF YOU NEED SERVICE

To obtain service, see the Consumer Services page in the back of this guide.

We're proud of our service and want you to be pleased. If for some reason you are not happy with the service you receive, here are three steps to follow for further help.

FIRST, contact the people who serviced your appliance. Explain why you are not pleased. In most cases, this will solve the problem.

NEXT, if you are still not pleased, write all the details—including your phone number—to:

Manager, Consumer Relations
GE Appliances
Appliance Park
Louisville, KY 40225

FINALLY, if your problem is still not resolved, write:

Major Appliance Consumer Action Program
20 North Wacker Drive
Chicago, IL 60606

WARNING: If the information in this guide is not followed exactly, a fire or explosion may result causing property damage, personal injury or death.

— **Do not store or use gasoline or other flammable vapors and liquids in the vicinity of this or any other appliance.**

— **WHAT TO DO IF YOU SMELL GAS**

• **Do not try to light any appliance.**

• **Do not touch any electrical switch; do not use any phone in your building.**

• **Immediately call your gas supplier from a neighbor's phone. Follow the gas supplier's instructions.**

• **If you cannot reach your gas supplier, call the fire department.**

— **Installation and service must be performed by a qualified installer, service agency or the gas supplier.**

IMPORTANT SAFETY INSTRUCTIONS

Read all instructions before using this appliance.



IMPORTANT SAFETY NOTICE

- **The California Safe Drinking Water and Toxic Enforcement Act** requires the Governor of California to publish a list of substances known to the state to cause cancer, birth defects or other reproductive harm, and requires businesses to warn customers of potential exposure to such substances.
- **Gas appliances can cause minor exposure to four of these substances**, namely benzene, carbon monoxide, formaldehyde and soot, caused primarily by the incomplete combustion of natural gas or LP fuels. Properly adjusted burners, indicated by a bluish rather than a yellow flame, will minimize incomplete combustion. Exposure to these substances can be minimized further by venting with an open window or using a ventilation fan or hood.

When You Get Your Oven

- **Have the installer show you the location of the oven gas cut-off valve and how to shut it off if necessary.**
- **Have your oven installed and properly grounded by a qualified installer**, in accordance with the Installation Instructions. Any adjustment and service should be performed only by qualified gas oven installers or service technicians.
- **Do not attempt to repair or replace any part of your oven unless it is specifically recommended in this guide.** All other servicing should be referred to a qualified technician.
- **Be sure all packaging materials are removed from the oven** before operating it, to prevent fire or smoke damage should the packaging material ignite.
- **Be sure the oven is securely installed in a cabinet that is firmly attached to the house structure.** Never allow anyone to climb, sit, stand or hang on the oven door.
- **Be sure your oven is correctly adjusted by a qualified service technician or installer for the type of gas (Natural or LP) that is to be used.** Your oven can be converted for use on either type of gas. See the Installation Instructions.

WARNING: These adjustments must be made by a qualified service technician in accordance with the manufacturer's instructions and all codes and requirements of the authority having jurisdiction. Failure to follow these instructions could result in serious injury or property damage. The qualified agency performing this work assumes responsibility for the conversion.

Using Your Oven

- **Do not leave children alone or unattended where an oven is hot or in operation.** They could be seriously burned.
- **Do not allow anyone to climb, stand or hang on the door or the broiler drawer.** They could damage the oven.
- **CAUTION: ITEMS OF INTEREST TO CHILDREN SHOULD NOT BE STORED IN CABINETS ABOVE AN OVEN—CHILDREN CLIMBING ON THE OVEN TO REACH ITEMS COULD BE SERIOUSLY INJURED.**
- **Teach children not to play with the controls** or any other part of the oven.
- **Never leave the oven door open** when you are not watching the oven.
- **Always keep combustible wall coverings, curtains or drapes a safe distance from your oven.**
- **Never wear loose fitting or hanging garments while using the appliance.** Be careful when reaching for items stored in cabinets over the oven. Flammable material could be ignited if brought in contact with flame or hot oven surfaces and may cause severe burns.
- **For your safety, never use your appliance for warming or heating the room.**
- **Do not use water on grease fires.** Smother fire or flame or use a multi-purpose dry chemical or foam-type fire extinguisher.



Flame in the oven can be smothered completely by closing the oven door and turning the oven off or by using a multi-purpose dry chemical or foam-type fire extinguisher.

(continued next page)



IMPORTANT SAFETY INSTRUCTIONS

(continued)



- **Use only dry pot holders**—moist or damp pot holders on hot surfaces may result in burns from steam. Do not let pot holders come near open flames when lifting cookware. Do not use a towel or other bulky cloth. Such cloths can catch fire on a hot burner.
- **Always keep dish towels, dish cloths, pot holders and other linens a safe distance from your oven.**
- **Always keep wooden and plastic utensils and canned food a safe distance away from your oven.**
- **Do not leave paper products, cooking utensils or food in the oven when not in use.**
- **DO NOT STORE OR USE COMBUSTIBLE MATERIALS, GASOLINE OR OTHER FLAMMABLE VAPORS AND LIQUIDS IN THE VICINITY OF THIS OR ANY OTHER APPLIANCE.**
- **Do not let cooking grease or other flammable materials accumulate in or near the oven.**
- **Do not use the oven as a storage area.** Items stored in an oven can ignite.
- **Do not touch the interior surface of the oven.** These surfaces may be hot enough to burn even though they are dark in color. During and after use, do not touch, or let clothing or other flammable materials contact, any interior area of the oven: allow sufficient time for cooling first.
Potentially hot surfaces include the oven vent openings, surfaces near the openings and crevices around the door.
Remember: The inside surfaces of an oven may be hot when the door is opened.
- **Keep the oven clean and free of accumulations of grease or spillovers, which may ignite.**
- **When cooking pork,** follow the directions exactly and always cook the meat to an internal temperature of at least 170°F. This assures that, in the remote possibility that trichina may be present in the meat, it will be killed and meat will be safe to eat.

- **Stand away from the oven when opening the oven door.** The hot air or steam that escapes can cause burns to hands, face and/or eyes.
- **Do not heat unopened food containers.** Pressure could build up and the container could burst, causing an injury.
- **Keep the oven vent ducts unobstructed.**



- **Keep the oven free from grease build-up.**
- **Place the oven shelf in the desired position while the oven is cool.**
- **Pulling out the shelf to the stop-lock is a convenience in lifting heavy foods.** It is also a precaution against burns from touching the hot surfaces of the door or the oven walls.
- **When using cooking or roasting bags in the oven,** follow the manufacturer's directions.
- **Do not use your oven to dry newspapers.** If overheated, they can catch fire.
- **Do not use aluminum foil anywhere in the oven except as described in this guide.** Misuse could result in a fire hazard or damage to the oven.
- **Use only glass cookware that is recommended for use in gas ovens.**
- **After broiling,** always take the broiler pan out of the broiler compartment and clean it. Leftover grease in the broiler pan can catch fire next time you use the pan.
- **If you should have a grease fire in the broiler pan,** turn the oven off and keep the oven and broiler drawer door closed to contain the fire until it burns out.
- **When broiling, if meat is too close to the flame, the fat may ignite.** Trim excess fat to prevent excessive flare-ups.
- **Never leave jars or cans of fat drippings in or near your oven.**

SAVE THESE INSTRUCTIONS

FEATURES OF YOUR OVEN

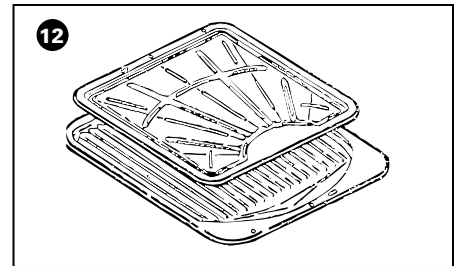
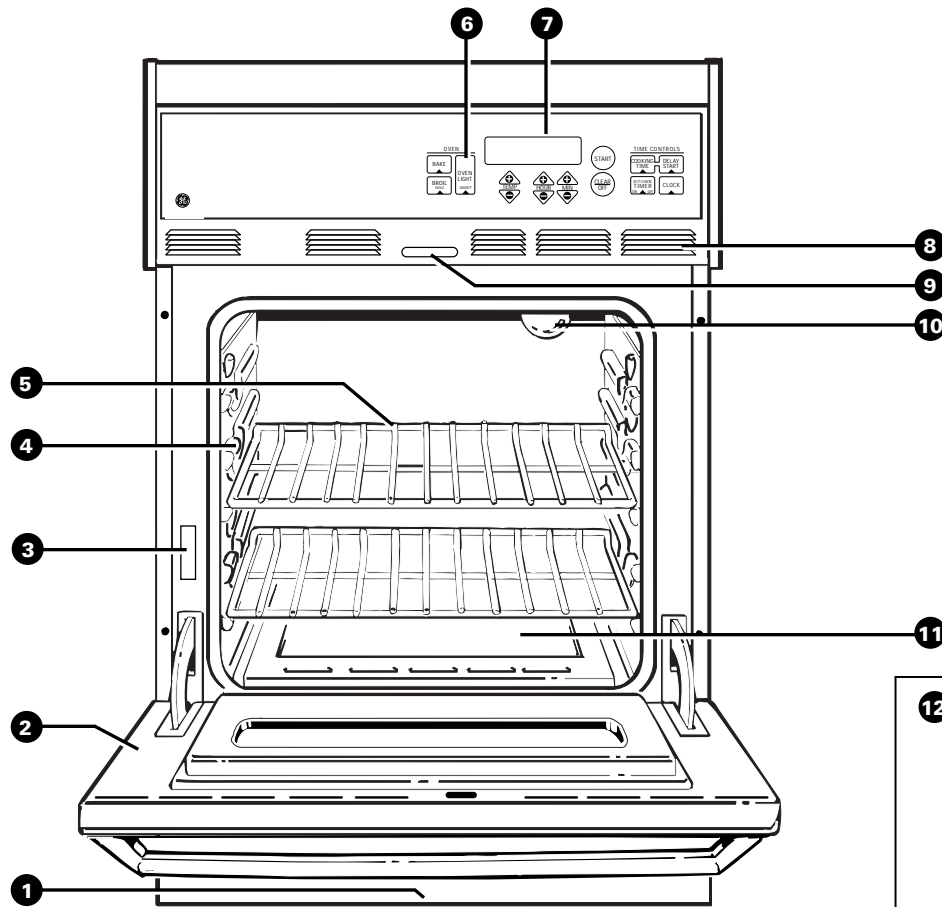

Feature Index	Explained on page
1 Broiler Drawer	20, 21, 23
2 Lift-Off Oven Door Easily removed for oven cleaning.	23
3 Model and Serial Numbers	2
4 Oven Shelf Supports Shelf positions for cooking are suggested in the Baking and Roasting sections.	12, 13, 18
5 Oven Shelves with Stop-Locks	11, 13, 18, 22

Feature Index	Explained on page
6 Oven Light Pad Lets you turn the interior oven light on and off.	—
7 Oven Control, Clock and Timer	6–10, 22
8 Oven Vent Grille	4, 11
9 Oven Vent	4, 11
10 Oven Interior Light	22
11 Removable Oven Bottom	24
12 Broiler Pan and Grid	4, 18, 20, 21, 23



FEATURES OF YOUR OVEN CONTROL

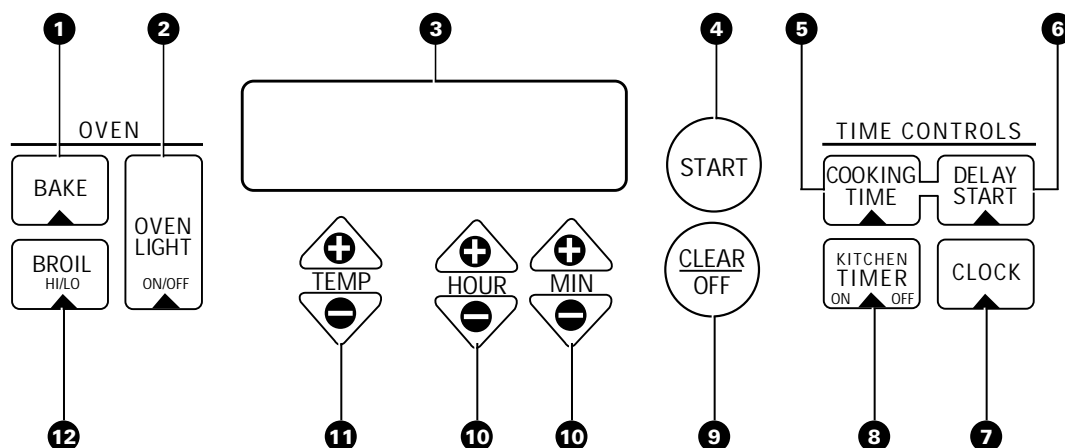

- 1. BAKE.** Press to select the bake function.
- 2. OVEN LIGHT ON/OFF.** Press to turn the oven light on or off.
- 3. DISPLAY.** Shows the operations you have selected, the time of day and the cooking status.
- 4. START.** Must be pressed to start any cooking function.
- 5. COOKING TIME.** Use for Timed Bake.
- 6. DELAY START.** Use along with COOKING TIME to set the oven to start and stop automatically at a time you select.
- 7. CLOCK.** Press to enter the time of day.
- 8. KITCHEN TIMER ON/OFF.** Press to select the timer function. The timer does not control oven operations. The timer can time up to 9 hours and 59 minutes.
- 9. CLEAR/OFF.** Press to cancel any timed oven operation except the clock and timer.
- 10. HOUR +/- and MIN +/- pads.** Press to set times up to 9 hours and 59 minutes—for example, the time of day on the clock, the timer and the starting and length of cooking time for Timed Bake.
- 11. TEMP +/- pads.** Press to set the cooking temperature you want to use.
- 12. BROIL HI/LO.** Press to select the broil function.

If “F—and a number or letter” flash in the display and the oven control signals, this indicates function error code. Press CLEAR/OFF. Allow the oven to cool for one hour. Put the oven back into operation. If function error code repeats, disconnect power to the oven and call for service.

OVEN CONTROL, CLOCK AND TIMER



Clock

The clock must be set for the automatic oven timing functions to work properly.

The time of day clock **cannot** be changed during Delay Start. (It can be changed during a regular bake or broil operation.)

To Set the Clock



1. Press CLOCK.



2. Press the HOUR and MIN + or – pads to set the time of day.



3. Press START. This enters the time and starts the clock.

To check the time of day when the display is showing other information, simply press CLOCK. The time of day shows until another pad is pressed.

Timer

You may program the timer to time cooking or other household activities for up to 9 hours and 59 minutes.

The timer counts down in minutes, 1 minute at a time, until the last 60 seconds are reached, then the control will beep one time. The seconds will not be displayed until the last minute is reached.

When the timer reaches “:00,” the control will beep 3 times followed by one beep every 6 seconds until KITCHEN TIMER ON/OFF is pressed.

The 6 second tone can be canceled by following the steps in the Special Features of Your Oven Control section under Tones at the End of a Timed Cycle.

How to Set the Timer



1. Press KITCHEN TIMER ON/OFF.



2. Press the HOUR and MIN + or – pads until the amount of time you want shows in the display.

If you make a mistake, press KITCHEN TIMER ON/OFF and begin again.



3. Press START.

After pressing START, “SET” disappears; this tells you the time is counting down, although the display does not change until one minute has passed.



4. When time is up, the oven control signals until you press KITCHEN TIMER ON/OFF. Display then shows the time of day.

NOTE: The minute timer is independent of all the other functions and it does not control the oven. The CLEAR/OFF pad does not affect the timer.

Power Failure

If a flashing time of day is in the display, you have experienced a power failure. Reset the clock.

To reset the clock, press CLOCK. Enter the correct time of day by pressing the HOUR and MIN + or – pads. Press START.

(continued next page)



OVEN CONTROL, CLOCK AND TIMER

(continued)

The control has a series of tones that will sound at different times. These tones may sound while you set the control for an oven function or at the end of the oven function. They will also alert you when an incorrect time or temperature has been entered or if there is a problem with the oven.

Tones While Setting the Control

When you press a touch pad you will hear a beep. This beep will let you know you have placed enough pressure on the pad to activate it.

Preheat Notification Tone

When you set an oven temperature the oven automatically starts to heat. When the temperature inside the oven reaches your set temperature a tone will sound to let you know to place the food in the oven.

Attention Tone

This tone will sound if you set an invalid function or try to set an additional function. The tone can be quickly identified by watching the display messages.

SPECIAL FEATURES OF YOUR OVEN CONTROL

Your new touch pad control has additional features that you may choose to use. The following are the features and how you may activate them. The special feature modes can only be activated while the display is showing the time of day clock.

They remain in the control's memory until the steps are repeated. When the display shows your choice press START. The special features will remain in memory after a power failure.

Tones at the End of a Timed Cycle

At the end of a timed cycle, 3 short beeps will sound followed by one beep every 6 seconds, until CLEAR/OFF is pressed. This continuous 6 second beep may be canceled.

To cancel the 6 second beep:



1. Press BAKE and BROIL HI/LO at the same time for 2 seconds until the display shows "SF."



2. Press KITCHEN TIMER ON/OFF. The display shows "CON BEEP" (continuous beep). Press KITCHEN TIMER ON/OFF again. The display shows "BEEP." (This cancels the one beep every 6 seconds.)



3. Press START.

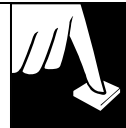

12 Hour Shut-Off

With this feature, should you forget and leave the oven on, the control will automatically turn off the oven after 12 hours during baking functions or after 3 hours during a broil function. If you wish to turn off this feature, follow the steps below.



1. Press BAKE and BROIL HI/LO at the same time for 2 seconds until the display shows "SF."



2. Press DELAY START. The display will show "12 shdn" (12 hour shut-off). Press DELAY START again and the display will show "no shdn" (no shut-off).



3. Press START to activate the no shut-off and leave the control set in this special features mode.

Cook and Hold

Your new control has a cook and hold feature that keeps cooked foods warm for up to 3 hours after the cooking function is finished. To activate this feature:



1. Press BAKE and BROIL HI/LO at the same time for 2 seconds until the display shows "SF."



2. Press COOKING TIME. The display will show "Hld OFF."

—Press COOKING TIME again to activate the feature. The display will show "Hld ON."



3. Press START to activate the cook and hold feature and leave the control set in this special features mode.

12 Hour, 24 Hour or Clock Black-Out

Your control is set to use a 12 hour clock. If you would prefer to have a 24 hour military time clock or black-out the clock display, follow the steps below.



1. Press BAKE and BROIL HI/LO at the same time for 2 seconds until the display shows "SF."



2. Press CLOCK once. The display will show "12 hr."
—Press CLOCK again to change to the 24 hour military time clock. The display will show "24 hr."
—Press CLOCK again to black-out the clock display. The display will show "OFF."



3. Press START to activate your choice and leave the control set in this special features mode.

NOTE: If the clock is in the black-out mode you will not be able to use the Delay Start function.

(continued next page)



SPECIAL FEATURES OF YOUR OVEN CONTROL

(continued)

Fahrenheit or Centigrade Temperature Selection

Your oven control is set to use the Fahrenheit temperature selections but you may change this to use the Centigrade selections.



1. Press BAKE and BROIL HI/LO at the same time for 2 seconds until the display shows "SF."



2. Press BROIL HI/LO. The display will show "F" (Fahrenheit).



3. Press BROIL HI/LO again. The display will show "C" (Centigrade).



4. Press START.

Changing the Speed of the + or – Pads

As you use the + or – pads when setting a time or temperature, you may notice the display changes slowly. This special feature allows you to change the speed. To set the speed you prefer, follow the steps below.



1. Press BAKE and BROIL HI/LO at the same time for 2 seconds until the display shows "SF."



2. Press the + pad. The display will show you a set speed between 1 and 5.



3. Press the + pad to increase the speed up to the number 5.



—Press the – pad to decrease the speed down to the number 1.



4. Press START to activate the setting and leave the control set in this special features mode.

USING YOUR OVEN



Before Using Your Oven

1. Look at the controls. Be sure you understand how to set them properly.
2. Check the oven interior. Look at the shelves. Take a practice run at removing and replacing them properly to give sure, sturdy support.
3. Read over the information and tips that follow.
4. Keep this guide handy so you can refer to it, especially during the first weeks of using your new oven.

NOTE:

- You may notice a “burning” or “oily” smell the first few times you turn your oven on. This is normal in a new oven and will disappear in a short time.
- A cooling fan may automatically turn on and off to cool internal parts. This is normal, and the fan may continue to run even after the oven is turned off.

Automatic Ignition

The oven burner is lit by electric ignition.



To light the burner, press the pad for the desired function and press the TEMP + or – pads until the desired temperature is displayed. The burner should ignite within 60 seconds.

After the oven reaches the selected temperature, the oven burner cycles off completely, then on with a full flame to keep the oven temperature controlled.

Oven Vent

When the oven is on, heated air moves through a vent behind the grille. See the Features of Your Oven section.

The vent area could get hot during oven use.

The vent is needed for proper air flow in the oven and good baking results. Do not block this vent. Doing so may cause oven failure or fire.

Power Outage

The oven burner will not light in the event of an electrical power outage.

Do not attempt to light it manually with a match.

Oven Shelves

The shelves are designed with stop-locks so that, when placed correctly on the shelf supports, they will stop before coming completely out of the oven and will not tilt when you are removing food from them or placing food on them.

When placing cookware on a shelf, pull the shelf out to the bump on the shelf support. Place the cookware on the shelf, then slide the shelf back into the oven. This will eliminate reaching into the hot oven.

To remove a shelf from the oven, pull the shelf toward you, tilt the front end upward and pull the shelf out.

To replace, place the shelf on the shelf support with the stop-locks (curved extension of the shelf) facing up and toward the rear of the oven. Tilt up the front and push the shelf toward the back of the oven until it goes past the bump on the shelf support. Then lower the front of the shelf and push it all the way back.

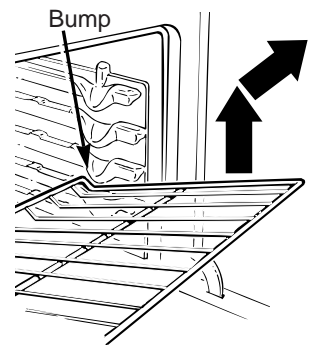

(continued next page)



USING YOUR OVEN

(continued)

Shelf Positions

The oven has 4 shelf supports, identified in this illustration as A (bottom), B, C and D (top).

Shelf positions for cooking are suggested in the Baking and Roasting sections.

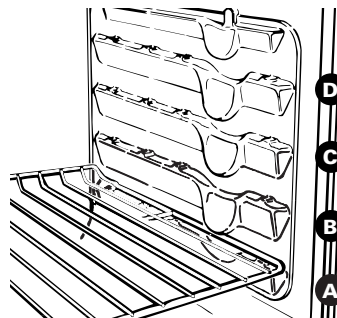

Oven Moisture

As your oven heats up, the changing temperature of the air in the oven may cause water droplets to form on the door glass. These droplets are harmless and will evaporate as the oven continues to heat up.

BAKING

Your oven temperature is controlled very accurately using an oven control system. It is recommended that you operate the oven for a number of weeks using the time given on recipes as a guide to become familiar with your new oven's performance.

If you think an adjustment is necessary, see the Adjust the Oven Thermostat section. It lists easy *Do It Yourself* instructions on how to adjust the thermostat.

How to Set Your Oven for Baking

To avoid possible burns, place the shelves in the correct position before you turn the oven on.



1. Press BAKE.

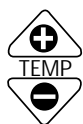

2. Press the TEMP + or – pads to set the oven temperature.



3. Press START.

When the oven starts to heat the changing temperature will be in the display. (The display starts changing once the temperature reaches 100°F.)



4. Press CLEAR/OFF when the baking is finished.

NOTE: A cooling fan may automatically turn on and off to cool internal parts. This is normal, and the fan may continue to run even after the oven is turned off.

To change the oven temperature during the Bake cycle, press BAKE and set the new temperature.



Oven Shelves

Arrange the oven shelf or shelves in the desired locations while the oven is cool. The correct shelf position depends on the kind of food and the browning desired. As a general rule, place most foods in the middle of the oven, on either shelf position B or C. See the chart for suggested shelf positions.

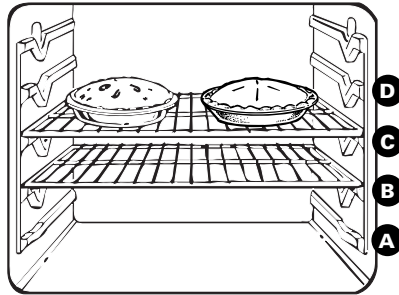

Type of Food	Shelf Position
Angel food cake	A
Biscuits or muffins	B or C
Cookies or cupcakes	B or C
Brownies	B or C
Layer cakes	B or C
Bundt or pound cakes	A or B
Pies or pie shells	B or C
Frozen pies	A (on cookie sheet)
Casseroles	B or C
Roasting	A or B

Preheating

Preheat the oven if the recipe calls for it. Preheat means bringing the oven up to the specified temperature before putting the food in the oven. To preheat, set the oven at the correct temperature—selecting a higher temperature does not shorten preheat time.

Preheating is necessary for good results when baking cakes, cookies, pastry and breads. For most casseroles and roasts, preheating is not necessary. For ovens without a preheat indicator light or tone, preheat 10 minutes. After the oven is preheated, place the food in the oven as quickly as possible to prevent heat from escaping.

Baking Pans

Use the proper baking pan. The type of finish on the pan determines the amount of browning that will occur.

- Dark, rough or dull pans absorb heat resulting in a browner, crisper crust. Use this type for pies.
- Shiny, bright and smooth pans reflect heat, resulting in a lighter, more delicate browning. Cakes and cookies require this type of pan.
- Glass baking dishes also absorb heat. When baking in glass baking dishes, the temperature may need to be reduced by 25°F.
- If you are using dark non-stick pans, you may find that you need to reduce the oven temperature 25°F. to prevent over-browning.

Pan Placement

For even cooking and proper browning, there must be enough room for air circulation in the oven. Baking results will be better if baking pans are centered as much as possible rather than being placed to the front or to the back of the oven.

Pans should not touch each other or the walls of the oven. Allow 1- to 1½-inch space between pans as well as from the back of the oven, the door and the sides. If you need to use two shelves, stagger the pans so one is not directly above the other.

(continued next page)



BAKING

(continued)

Cookies

When baking cookies, flat cookie sheets (without sides) produce better-looking cookies. Cookies baked in a jelly roll pan (short sides all around) may have darker edges and pale or light browning may occur.

Do not use a cookie sheet so large that it touches the walls or the door of the oven. Never entirely cover a shelf with a large cookie sheet.

For best results during baking, use only one cookie sheet in the oven at a time.

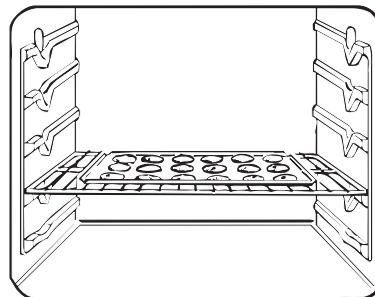

Pies

For best results, bake pies in dark, rough or dull pans to produce a browner, crisper crust. Frozen pies in foil pans should be placed on an aluminum cookie sheet for baking since the shiny foil pan reflects heat away from the pie crust; the cookie sheet helps retain it.

Cakes

When baking cakes, warped or bent pans will cause uneven baking results and poorly shaped products. A cake baked in a pan larger than the recipe recommends will usually be crisper, thinner and drier than it should be. If baked in a pan smaller than recommended, it may be undercooked and batter may overflow. Check the recipe to make sure the pan size used is the one recommended.

Aluminum Foil

Never entirely cover a shelf with aluminum foil. This will disturb the heat circulation and result in poor baking. A smaller sheet of foil may be used to catch a spillover by placing it on a lower shelf several inches below the food.

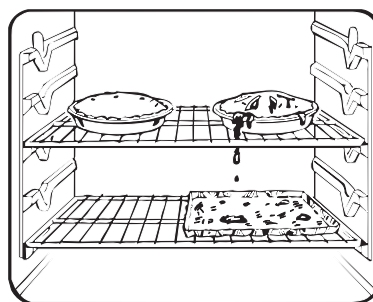

Don't Peek

Set the timer for the estimated cooking time and do not open the door to look at your food. Most recipes provide minimum and maximum baking times such as "bake 30-40 minutes."

DO NOT open the door to check until the minimum time. Opening the oven door frequently during cooking allows heat to escape and makes baking times longer. Your baking results may also be affected.

TIMED BAKING



How to Set Your Oven for Time Bake

The oven control allows you to turn the oven on or off automatically at specific times that you set. Examples of Immediate Start (oven turns on now and you set it to turn off automatically at the end of cooking time) and Delay Start and Stop (setting the oven to turn on automatically at a later time and turn off after a preset cooking time) will be described.

NOTE: Before beginning make sure the clock shows the correct time of day.



To set the clock, first press **CLOCK**. Press the **HOUR** and **MIN +** or **-** pads to set the time of day. Press **START**.

NOTE: An attention tone will sound if you are using Timed Baking and do not press **START** after entering the baking temperature.

How to Set Immediate Start and Automatic Stop

To avoid possible burns, place the shelves in the correct position before you turn the oven on.

The oven will turn on immediately and cook for a selected length of time. At the end of cooking time, the oven will turn off automatically.



1. Press **BAKE**.



2. Press the **TEMP +** or **-** pads to set the oven temperature.



3. Press **COOKING TIME**.

NOTE: If your recipe requires preheating, you may need to add additional time to the length of the cooking time.



4. Press the **HOUR** and **MIN +** or **-** pads to set the baking time.

The oven temperature and the cooking time that you entered will be displayed.



5. Press **START**. The display shows the oven temperature that you set and the cooking time countdown. (The display starts changing once the temperature reaches 100°F.)

The oven will continue to cook for the programmed amount of time, then shut off automatically.



6. Press **CLEAR/OFF** to clear the end of cycle tone if necessary.

NOTE:

- The low temperature zone of this oven (between 170°F. and 200°F.) is available to keep hot cooked foods warm. Food kept in the oven longer than two hours at these low temperatures may spoil.
- Foods that spoil easily, such as milk, eggs, fish, stuffings, poultry and pork, should not be allowed to sit for more than one hour before or after cooking. Room temperature promotes the growth of harmful bacteria. Be sure the oven light is off because heat from the bulb will speed harmful bacteria growth.

(continued next page)



TIMED BAKING

(continued)

How to Set Delay Start and Automatic Stop

Easy Steps:

1. Press **BAKE**.
2. Press the **TEMP** + or – pads to select oven temperature.
3. Press **COOKING TIME**.
4. Press the **HOUR** and **MIN** + or – pads to set the length of baking time.
5. Press **DELAY START**.
6. Press the **HOUR** and **MIN** + or – pads to set the desired start time.
7. Press **START**.

To avoid possible burns, place the shelves in the correct position before you turn the oven on.

You can set the control to delay the start of cooking, cook for a specific length of time and then turn off automatically.



1. Press **BAKE**.



2. Press the **TEMP** + or – pads to set the temperature.



3. Press **COOKING TIME**.

NOTE: If your recipe requires preheating, you may need to add additional time to the cooking time.



4. Press the **HOUR** and **MIN** + or – pads to set the baking time.



5. Press **DELAY START**.



6. Press the **HOUR** and **MIN** + or – pads to set the time of day you want the oven to turn on and start cooking.



7. Press **START**.



If you would like to check the times you have set, press **DELAY START** to check the start time you have set or press **COOKING TIME** to check the length of cooking time you have set.

When the oven turns on at the time of day you have set, the display will show the changing temperature (starting at 100°F.) and the cooking time countdown.

At the end of cooking time the oven will turn off and the end of cycle tone will sound.



8. Press **CLEAR/OFF** to clear the end of cycle tone if necessary.

NOTE:

- The low temperature zone of this oven (between 170°F. and 200°F.) is available to keep hot cooked foods warm. Food kept in the oven longer than two hours at these low temperatures may spoil.
- Foods that spoil easily, such as milk, eggs, fish, stuffings, poultry and pork, should not be allowed to sit for more than one hour before or after cooking. Room temperature promotes the growth of harmful bacteria. Be sure the oven light is off because heat from the bulb will speed harmful bacteria growth.

ADJUST THE OVEN THERMOSTAT— *DO IT YOURSELF!*



You may find that your new oven cooks differently than the one it replaced. We recommend that you use your new oven for a few weeks to become more familiar with it, following the times given in your recipes as a guide.

If you think your new oven is too hot or too cool, you can adjust the thermostat yourself. If you think it is too hot, adjust the thermostat to make it cooler. If you think it is too cool, adjust the thermostat to make it hotter.

We do not recommend the use of inexpensive thermometers, such as those found in grocery stores, to check the temperature setting of your new oven. These thermometers may vary 20–40 degrees.

To Adjust the Thermostat:

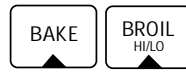

1. Press BAKE and BROIL HI/LO at the same time for 2 seconds until the display shows “SF.”
2. Press BAKE. A two digit number shows in the display.
3. The oven temperature can be adjusted up to (+) 35°F. hotter or (-) 35°F. cooler. Press the TEMP + pad to increase the temperature in 1 degree increments. Press the TEMP – pad to decrease the temperature in 1 degree increments.
4. When you have made the adjustment, press START to go back to the time of day display. Use your oven as you would normally.

NOTE: This adjustment will not affect the broiling temperature. It will be retained in memory after a power failure.



ROASTING

Roasting is cooking by dry heat. Tender meat or poultry can be roasted uncovered in your oven. Roasting temperatures, which should be low and steady, keep spattering to a minimum.

Roasting is really a baking procedure used for meats. Therefore, the oven controls are set for Baking or Timed Baking. (You may hear a slight clicking sound, indicating the oven is working properly.) Timed Baking will turn the oven on and off automatically.

Most meats continue to cook slightly after being removed from the oven. The internal temperature will rise about 5° to 10°F. during the recommended standing time of 10 to 20 minutes. This allows roasts to firm up and makes them easier to carve. To compensate for this rise in temperature, you may want to remove the roast sooner (at 5° to 10°F. less than the temperature in the Roasting Guide).

Remember that food will continue to cook in the hot oven and therefore should be removed when the desired internal temperature has been reached.

How to Set Your Oven for Roasting

1. Place the shelf in A or B position. No preheating is necessary.

2. Check the weight of the meat. Place the meat fat side up, or poultry breast side up, on roasting grid in a shallow pan. The melting fat will baste the meat. Select a pan as close to the size of the meat as possible.

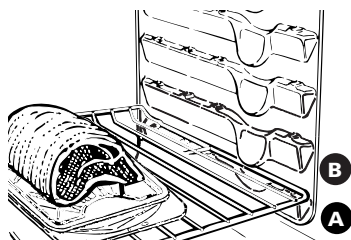

(The broiler pan with grid is a good pan for this.)



3. Press BAKE.



4. Press the TEMP + or – pads to set the temperature.



5. Press START.



6. Press CLEAR/OFF when roasting is finished.

To change the oven temperature during the roasting cycle, press BAKE and set the new temperature.

Use of Aluminum Foil

You can use aluminum foil to line the broiler pan. This makes clean-up easier when using the pan for marinating, cooking with fruits, cooking heavily cured meats or basting food during cooking. Press the foil tightly around the inside of the pan.



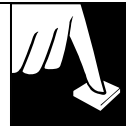

Questions and Answers

Q. Is it necessary to check for doneness with a meat thermometer?

A. Checking the finished internal temperature at the completion of cooking time is recommended. Temperatures are shown in the Roasting Guide. For roasts over 8 lbs. check with thermometer at half-hour intervals after half the cooking time has passed.

Q. Why is my roast crumbling when I try to carve it?

A. Roasts are easier to slice if allowed to cool 10 to 20 minutes after removing them from the oven. Be sure to cut across the grain of the meat.

Q. Do I need to preheat my oven each time I cook a roast or poultry?

A. It is not necessary to preheat your oven.

Q. When buying a roast, are there any special tips that would help me cook it more evenly?

A. Yes. Buy a roast as even in thickness as possible, or buy rolled roasts.

Q. Can I seal the sides of my foil "tent" when roasting a turkey?

A. Sealing the foil will steam the meat. Leaving it unsealed allows the air to circulate and brown the meat.

ROASTING GUIDE

Frozen Roasts

Frozen roasts of beef, pork, lamb, etc., can be started without thawing, but allow 10 to 25 minutes per pound additional time (10 minutes per pound for roasts under 5 pounds, more time for larger roasts).

Make sure poultry is thawed before roasting. Unthawed poultry often does not cook evenly. Some commercial frozen poultry can be cooked successfully without thawing. Follow the directions given on the package label.

Type	Oven Temperature	Doneness	Approximate Roasting Time in Minutes per Pound		Internal Temperature °F.
Meat			3 to 5 lbs.	6 to 8 lbs.	
Tender cuts; rib, high quality sirloin tip, rump or top round†	325°	Rare: Medium: Well Done:	24–33 35–39 40–45	18–22 22–29 30–35	140°–150°* 150°–160° 170°–185°
Lamb leg or bone-in shoulder†	325°	Rare: Medium: Well Done:	21–25 25–30 30–35	20–23 24–28 28–33	140°–150°* 150°–160° 170°–185°
Veal shoulder, leg or loin†	325°	Well Done:	35–45	30–40	170°–180°
Pork loin, rib or shoulder†	325°	Well Done:	35–45	30–40	170°–180°
Ham, precooked	325°	To Warm:	17–20 minutes per pound (any weight)		115°–125°
Poultry			3 to 5 lbs.	Over 5 lbs.	
Chicken or Duck	325°	Well Done:	35–40	30–35	185°–190°
Chicken pieces	350°	Well Done:	35–40		185°–190°
Turkey	325°	Well Done:	10 to 15 lbs. 18–25	Over 15 lbs. 15–20	In thigh: 185°–190°

†For boneless rolled roasts over 6 inches thick, add 5 to 10 minutes per pound to times given above.

*The U.S. Department of Agriculture says "Rare beef is popular, but you should know that cooking it to only 140°F. means some food poisoning organisms may survive." (Source: Safe Food Book. Your Kitchen Guide. USDA Rev. June 1985.)



BROILING

Broiling is cooking food by direct heat from above the food. Your oven has a convenient compartment below the oven for broiling. It also has a specially designed broiler pan and grid that allow dripping fat to drain away from the foods and be kept away from the high heat of the gas flame.

Distance from the heat source may be changed by positioning the broiler pan and grid on one of three shelf positions in the broiler compartment—A (bottom of broiler compartment), B (middle) and C (top).

If the meat has fat or gristle around the edge, cut vertical slashes through it about 2 inches apart. If desired, the fat may be trimmed, leaving a layer about 1/8-inch thick.

Steaks and chops should be at least 1-inch thick for best broiling results. Pan broil thinner ones.

Remove the broiler pan and grid from the broiler compartment and place the food on the grid.

Pull out the drawer and position the broiler pan in the compartment placing the sump area of the broiler pan to the front of the drawer.

Placing food closer to the flame increases the exterior browning of food, but also increases spattering and the possibility of fats and meat juices igniting.

Both the oven door and the broiler compartment drawer must be closed during broiling.

Turn most foods using tongs once during broiling (the exception is thin fillets of fish; oil one side, place that side down on the broiler grid and cook without turning until done). Time the foods for about one-half of the total cooking time, turn the food, then continue to cook to the preferred doneness.

How to Set Your Oven for Broiling



1. Press BROIL HI/LO.
2. Press BROIL HI/LO again (alternates between LO Broil and HI Broil).



3. Press START.



4. Press CLEAR/OFF when broiling is finished.

Use of Aluminum Foil

You can use aluminum foil to line your broiler pan and broiler grid. However, you must mold the foil tightly to the grid and cut slits in it just like the grid.

Without the slits, the foil will prevent fat and meat juices from draining into the broiler pan. The juices could become hot enough to catch on fire. If you do not cut the slits, you are frying, not broiling.

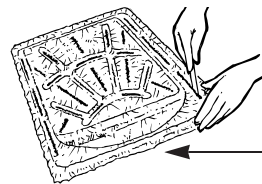

Always place sump to the front of the drawer.

Questions and Answers

Q. Why are my meats not turning out as brown as they should?

A. Check to see if you are using the recommended shelf position. Broil for the longest period of time indicated in the Broiling Guide. Turn the food only once during broiling.

Q. Should I salt the meat before broiling?

A. No. Salt draws out the juices and allows them to evaporate. Always salt after cooking. Piercing the meat with a fork allows juices to escape. Turn the meat with tongs instead of a fork.

Q. When broiling, is it necessary to always use a grid in the pan?

A. Yes. Using the grid suspends the meat over the pan. As the meat cooks, the juices fall into the pan, thus keeping the meat drier. Juices are protected by the grid and stay cooler, thus preventing excessive spatter and smoking.

BROILING GUIDE



- **Both the oven door and the broiler compartment drawer must be closed during broiling.**
- Always use the broiler pan and grid that comes with your oven. It is designed to minimize smoking and spattering by trapping the juices in the shielded lower part of the pan.
- For steaks and chops, slash fat evenly around the outside edges of the meat. To slash, cut crosswise through the outer fat surface just to the edge of the meat. Use tongs to turn the meat over to prevent piercing the meat and losing juices.
- If desired, marinate meats or chicken before broiling. Or brush with barbecue sauce last 5 to 10 minutes only.

- When arranging the food on the pan, do not let fatty edges hang over the sides because the dripping fat will soil the oven.
- The broiler compartment does not need to be preheated. However, for very thin foods, or to increase browning, preheat if desired.
- Use LO Broil to cook foods such as poultry or thick pork chops evenly without over-browning them.
- Frozen steaks can be broiled by positioning the shelf at next lowest shelf position and increasing cooking time given in this guide 1½ times per side.

Food	Quantity and/or Thickness	Broil Position	First Side Time, Minutes	Second Side Time, Minutes	Comments
Bacon	1/2 lb. (about 8 thin slices)	B	3½	3	Arrange in single layer.
Ground Beef Well Done	1 lb. (4 patties) 1/2 to 3/4 inch thick	B	8-9	6-7	Space evenly. Up to 8 patties take about same time.
Beef Steaks					
Rare	1 inch thick	B	9	7	Steaks less than 1-inch thick cook through before browning. Pan frying is recommended.
Medium	(1-1½ lbs.)	B	12	5-6	
Well Done		B	13	8-9	
Rare	1½ inches thick	B, C	10	6-7	Slash fat.
Medium	(2-2½ lbs.)	B	15	12-14	
Well Done		B	25	16-18	
Chicken	1 whole (2 to 2½ lbs.), split lengthwise	A	30-35	25-30	Reduce times about 5 to 10 minutes per side for cut-up chicken. Brush each side with melted butter. Broil with skin-side-down first.
Bakery Products					
Bread (Toast) or Toaster Pastries	2-4 slices	C	2-3	1/2-1	Space evenly. Place English muffins cut-side-up and brush with butter, if desired.
English Muffins	1 pkg. (2) 2 split	C	3-5		
Lobster Tails	2-4 (6 to 8 oz. each)	B	13-16	Do not turn over.	Cut through back of shell, spread open. Brush with melted butter before broiling and after half of broiling time.
Fish	1-lb. fillets 1/4 to 1/2 inch thick	B, C	5	5	Handle and turn very carefully. Brush with lemon butter before and during cooking, if desired. Preheat broiler to increase browning.
Ham Slices Precooked	1 inch thick	B	8	8	Increase times 5 to 10 minutes per side for 1½-inch thick or home cured.
Pork Chops Well Done	2 (1/2 inch thick) 2 (1 inch thick), about 1 lb.	B B	10 13	4-5 9-12	Slash fat.
Lamb Chops					
Medium	2 (1 inch thick),	B	8	4-7	Slash fat.
Well Done	about 10-12 oz.	B	10	10	
Medium	2 (1½ inches thick),	B	10	4-6	
Well Done	about 1 lb.	B	17	12-14	
Wieners, similar precooked sausages, bratwurst	1-lb. pkg. (10)	B, C	6	1-2	If desired, split sausages in half lengthwise; cut into 5- to 6-inch pieces.



CARE AND CLEANING

Proper care and cleaning are important so your oven will give you efficient and satisfactory service. Follow these directions carefully in caring for it to help assure safe and proper maintenance.

Porcelain Oven Interior

With proper care, the porcelain enamel finish on the inside of the oven—top, bottom, sides, back and inside of the door— will stay new-looking for years.

Let the oven cool before cleaning. We recommend that you wear rubber gloves when cleaning the oven.

Soap and water will normally do the job. Heavy spattering or spillovers may require cleaning with a mild abrasive cleaner. Soapy, wet metal pads may also be used. Do not allow food spills with a high sugar or acid content (such as milk, tomatoes, sauerkraut, fruit juices or pie filling) to remain on the surface. They may cause a dull spot even after cleaning.

Household ammonia may make the cleaning job easier. Place 1/2 cup in a shallow glass or pottery container in a cold oven overnight. The ammonia fumes will help loosen the burned-on grease and food.

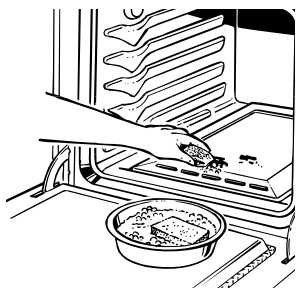

If necessary, you may use an oven cleaner. Follow package directions.

Cautions about using spray-on oven cleaners:

- **Do not** spray on the electrical controls and switches because it could cause a short circuit and result in sparking or fire.
- **Do not** allow a film from the cleaner to build up on the temperature sensor—it could cause the oven to heat improperly. (The sensor is located at the top of the oven.) Carefully wipe the sensor clean after each oven cleaning, being careful not to move the sensor as a change in its position could affect how the oven bakes.
- **Do not** spray any oven cleaner on the outside of the door, handles or any exterior surface of the oven, cabinet or painted surfaces. The cleaner can damage these surfaces.

Oven Light

The light bulb is located in the upper right corner of the oven. Before replacing the bulb, disconnect electrical power to the oven at the main fuse or circuit breaker panel. Let the bulb cool completely before removing it. Replace the bulb with a 40-watt appliance bulb only. Do not touch a hot bulb with a damp cloth because the bulb will break.



Control Panel

It's a good idea to wipe the control panel after each use. Clean with mild soap and water or vinegar and water, rinse with clean water and polish dry with a soft cloth.

Do not use abrasive cleansers, strong liquid cleaners, plastic scouring pads or oven cleansers on the control panel—they will damage the finish. A 50/50 solution of vinegar and hot water works well.

Oven Shelves

The oven shelves may be cleaned with a mild abrasive cleanser or steel wool. After cleaning, rinse the shelves with clean water and dry with a clean cloth.



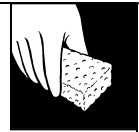

Lift-Off Oven Door

The oven door is removable, but it is heavy. You may need help removing and replacing the door. Do not lift the door by the handle. This can cause the glass to break or can cause damage to the door.

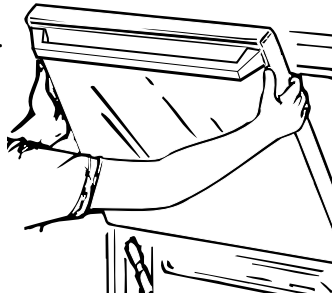

To remove the door, open it a few inches to the special stop position that will hold the door open. Grasp firmly on each side and lift the door straight up and off the hinges.

NOTE:

- Be careful not to place hands between the hinge and the oven door frame as the hinge could snap back and pinch fingers.
- While working in the oven area, cover the hinges with towels or empty paper towel rolls to prevent pinched fingers and chipping the porcelain enamel on the frame.

To replace the door, make sure the hinges are in the special stop position. Position the slots in the bottom of the door squarely over the hinges at the same time. If the hinges snap back against the oven frame, pull them back out.

TO CLEAN THE DOOR:

Inside of door:

- **Soap and water will normally do the job.** Heavy spattering or spillovers may require cleaning with a mild abrasive cleaner. Soapy, wet metal pads may also be used. Do not allow food spills with a high sugar or acid content (such as milk, tomatoes, sauerkraut, fruit juices or pie filling) to remain on the surface. They may cause a dull spot even after cleaning.
- **If necessary, you may use an oven cleaner.** Follow the package directions. **Do not use oven cleaners, cleansing powders or harsh abrasives on the outside of the door.**

Outside of door:

- Use soap and water to thoroughly clean the top, sides and front of the oven door. Rinse well. You may also use a glass cleaner to clean the glass on the outside of the door.
- Spillage of marinades, fruit juices, tomato sauces and basting materials containing acids may cause discoloration and should be wiped up immediately. When the surface is cool, clean and rinse.

Broiler Drawer

To remove:

1. When the broiler is cool, remove the grid and pan.
2. Pull the broiler drawer out until it stops, then push it back in about 1".
3. Grasp handle, lift and pull broiler drawer out (lift the rollers located under the drawer over the roller guides in the oven).

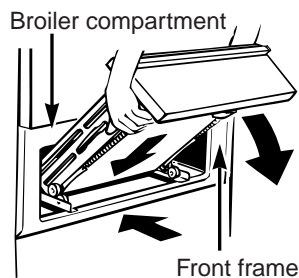

To replace:

1. Put the rollers under the broiler drawer behind the roller guide stops in the oven.
2. Hold the broiler drawer in the raised position as you slide it partway into the oven. Then lower the drawer and push it completely closed.

Broiler Pan and Grid

After broiling, remove the broiler pan from the broiler drawer. Remove the grid from the pan. Carefully pour out grease from the pan into a proper container. Wash and rinse the broiler pan and grid in hot water with a soap-filled or plastic scouring pad.

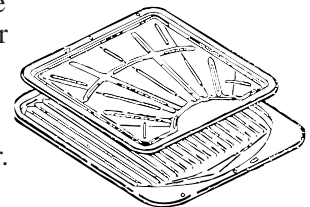

If food has burned on, sprinkle the grid with detergent while hot and cover with wet paper towels or a dishcloth. Soaking the pan will remove burned on foods.

Both the broiler pan and grid may be cleaned with a commercial oven cleaner.

Do not store a soiled broiler pan and grid anywhere in the oven.

Both the broiler pan and grid can also be cleaned in the dishwasher.

(continued next page)



CARE AND CLEANING

(continued)

Removable Oven Bottom

The oven bottom can be removed to clean large spills, and to enable you to reach the oven burner.

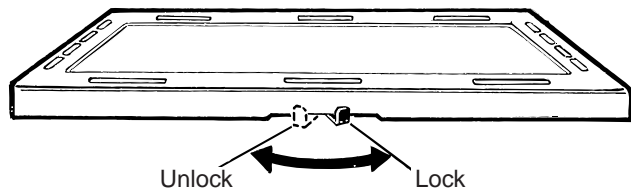

TO REMOVE:

1. Slide the tab at the center front of the oven bottom to the left.
2. Lift the oven bottom up and out.

TO REPLACE:

1. Slip the oven bottom into the oven so the tabs in the rear of the oven bottom fit into the slots in the oven back.
2. Lower the front of the oven bottom into place and slide the front tab to the right to lock the oven bottom into place.

The oven bottom has a porcelain enamel finish.

To make cleaning easier, protect the oven bottom from excessive spillovers. This is particularly important when baking a fruit pie or other foods with high acid content. Hot fruit fillings or foods that are acidic (such as milk, tomatoes or sauerkraut, and sauces with vinegar or lemon juice) may cause pitting and damage to the porcelain enamel surface.

To protect the oven bottom surface, place a piece of aluminum foil slightly larger than the baking dish or a small cookie sheet on a lower shelf or under the baking dish to catch any spillovers. It should not completely cover the shelf as this would cause uneven heat in the oven. Aluminum foil should not be placed on the oven bottom.

If a spillover does occur on the oven bottom, allow the oven to cool first. You can clean the oven bottom with soap and water, a mild abrasive cleanser or soap-filled abrasive pads. Rinse well.



MINOR ADJUSTMENTS YOU CAN MAKE

Broil and Oven Burner Air Adjustment Shutters

Air adjustment shutters for the burner regulate the flow of air to the flames.

To adjust the air shutter, remove the oven bottom. Turn the burner full on and check the flames. The burner flames should not flutter or blow away from the burner. They should be blue in color with no trace of yellow. Foreign particles in the gas line may cause an orange flame at first, but this will soon disappear. If the flames are yellow or flutter, open the air shutter more. If they blow away from the burner, close the air shutter more.

If necessary, use a screwdriver to loosen the air shutter screw. Then adjust the air shutter and, when the flames are right, retighten the air shutter screw.

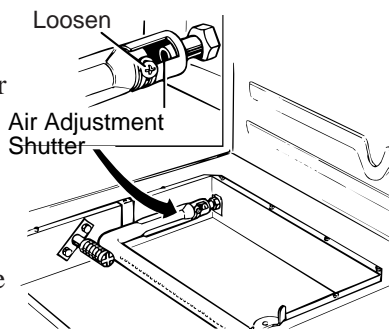

To adjust the orifice hoods, check the inner cone of the flame.

WARNING: If you attempt to measure the inner cone of the flame, please use caution. Burns could result.

The inner cone of the flames should be about 1/2" long. If the flames are not right, use a 1/2" open-end wrench or adjustable joint pliers to adjust the orifice hood.

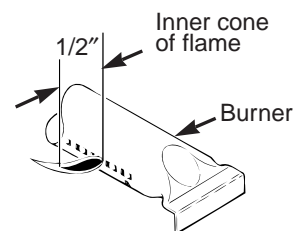

To shorten the cones, tighten the orifice hood by turning in the "L.P." direction. To lengthen the cones, loosen the orifice hood by turning in the "Nat." direction.

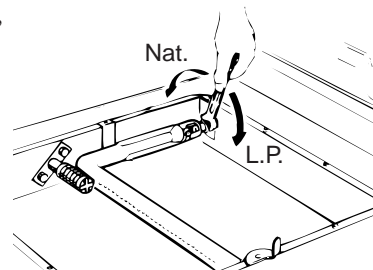

When checking the flames, before and after adjustments, the oven door should be closed.

QUESTIONS? USE THIS PROBLEM SOLVER



PROBLEM	POSSIBLE CAUSE
“F—AND A NUMBER OR LETTER” FLASH IN THE DISPLAY	<ul style="list-style-type: none"> • This is a function error code. Press CLEAR/OFF. Allow the oven to cool one hour. Place the oven back into operation. • Disconnect all power to the oven for 5 minutes and then reconnect power. If the failure code repeats, call for service.
CONTROL SIGNALS AFTER ENTERING COOKING TIME OR DELAY START TIME	<ul style="list-style-type: none"> • This is reminding you to press BAKE and then enter a temperature. • This is reminding you to enter a bake temperature after having pressed BAKE.
DISPLAY GOES BLANK	<ul style="list-style-type: none"> • The circuit breaker in your house has been tripped, or a fuse has been blown.
DISPLAY FLASHES	<ul style="list-style-type: none"> • Power failure. Reset the clock.
UNABLE TO GET THE DISPLAY TO SHOW “SF”	<ul style="list-style-type: none"> • BAKE and BROIL HI/LO must be pressed at the same time and held for 2 seconds.
CLOCK AND TIMER DO NOT WORK	<ul style="list-style-type: none"> • Check for power outage.
OVEN LIGHT DOES NOT WORK	<ul style="list-style-type: none"> • The light bulb is loose or defective. Tighten or replace. • The pad operating the oven light is broken. Call for service.
FOOD DOES NOT BROIL PROPERLY	<ul style="list-style-type: none"> • The oven controls are not properly set. See the Broiling section. • Improper shelf position being used. • Food is being cooked on a hot pan. • Cookware is not suited for broiling. • The oven door and/or the broiler compartment door not closed. • Aluminum foil used on the broiler pan grid has not been fitted properly and slit as recommended.
FOOD DOES NOT ROAST OR BAKE PROPERLY	<ul style="list-style-type: none"> • The oven controls are not properly set. See the Baking or Roasting section. • Shelf position is not correct. • Incorrect cookware or cookware of improper size is being used. • Oven thermostat needs adjustment. See the Adjust the Oven Thermostat—<i>Do It Yourself</i> section.

(continued next page)



PROBLEM SOLVER

(continued)

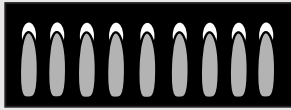
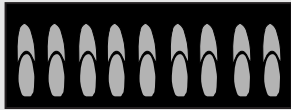
PROBLEM	POSSIBLE CAUSE
OVEN WILL NOT WORK	<ul style="list-style-type: none">• The circuit breaker in your house has been tripped, or a fuse has been blown.• The oven controls are not properly set.
OVEN TEMPERATURE TOO HOT OR TOO COLD	<ul style="list-style-type: none">• Oven thermostat needs adjustment. See the Adjust the Oven Thermostat—<i>Do It Yourself</i> section.
“BURNING” OR “OILY” ODOR EMITTING FROM OVEN WHEN TURNED ON	<ul style="list-style-type: none">• This is normal in a new oven and will disappear in time.
STRONG ODOR	<ul style="list-style-type: none">• Improper air/gas ratio in oven. Adjust the oven burner air shutter.• An odor from the insulation around the inside of the oven is normal for the first few times the oven is used. This is temporary.
BURNERS HAVE YELLOW OR YELLOW-TIPPED FLAMES	<div style="display: flex; justify-content: space-around; align-items: flex-start;"><div style="text-align: center;"><p>(A) Yellow flames— Call for service</p></div><div style="text-align: center;"><p>(B) Yellow tips on outer cones— Normal for LP gas</p></div><div style="text-align: center;"><p>(C) Soft blue flames— Normal for natural gas</p></div></div> <p>If burner flames look like (A), call for service. Normal burner flames should look like (B) or (C), depending on the type of gas you use.</p> <ul style="list-style-type: none">• With LP gas, some yellow tipping on outer cones is normal.
FAN NOISE	<ul style="list-style-type: none">• A cooling fan may automatically turn on and off to cool internal parts. This is normal and the fan may continue to run even after the oven is turned off.

If you need more help...call, toll free:

GE Answer Center[®]

800.626.2000

consumer information service

We'll Be There

With the purchase of your new GE appliance, receive the assurance that if you ever need information or assistance from GE, we'll be there. All you have to do is call—toll-free!

GE Answer Center® **800.626.2000**

Whatever your question about any GE major appliance, GE Answer Center® information service is available to help. Your call—and your question—will be answered promptly and courteously. And you can call any time. GE Answer Center® service is open 24 hours a day, 7 days a week.

In-Home Repair Service **800-GE-CARES (800-432-2737)**

A GE consumer service professional will provide expert repair service, scheduled at a time that's convenient for you. Many GE Consumer Service company-operated locations offer you service today or tomorrow, or at your convenience (7:00 a.m. to 7:00 p.m. weekdays, 9:00 a.m. to 2:00 p.m. Saturdays). Our factory-trained technicians know your appliance inside and out—so most repairs can be handled in just one visit.

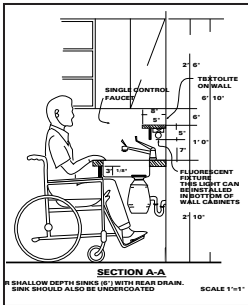

For Customers With Special Needs... **800.626.2000**

GE offers, free of charge, a brochure to assist in planning a barrier-free kitchen for persons with limited mobility.

Consumers with impaired hearing or speech who have access to a TDD or a conventional teletypewriter may call 800-TDD-GEAC (800-833-4322) to request information or service.

Service Contracts **800-626-2224**

You can have the secure feeling that GE Consumer Service will still be there after your warranty expires. Purchase a GE contract while your warranty is still in effect and you'll receive a substantial discount. With a multiple-year contract, you're assured of future service at today's prices.

Parts and Accessories **800-626-2002**

Individuals qualified to service their own appliances can have parts or accessories sent directly to their home. The GE parts system provides access to over 47,000 parts...and all GE Genuine Renewal Parts are fully warranted. VISA, MasterCard and Discover cards are accepted.

User maintenance instructions contained in this guide cover procedures intended to be performed by any user. Other servicing generally should be referred to qualified service personnel. Caution must be exercised, since improper servicing may cause unsafe operation.

YOUR GE GAS OVEN WARRANTY

Staple sales slip or cancelled check here. Proof of original purchase date is needed to obtain service under warranty.

WHAT IS COVERED

FULL ONE-YEAR WARRANTY

For one year from date of original purchase, we will provide, free of charge, parts and service labor in your home to repair or replace **any part of the oven** that fails because of a manufacturing defect.

This warranty is extended to the original purchaser and any succeeding owner for products purchased for ordinary home use in the 48 mainland states, Hawaii and Washington, D.C. In Alaska the warranty is the same except that it is LIMITED because you must pay to ship the product to the service shop or for the service technician's travel costs to your home. All warranty service will be provided by our Factory Service Centers or by our authorized Customer Care® servicers during normal working hours. Should your appliance need service, during warranty period or beyond, call 800-GE-CARES (800-432-2737).

WHAT IS NOT COVERED

- Service trips to your home to teach you how to use the product.
Read your Use and Care material. If you then have any questions about operating the product please contact your dealer or our Consumer Affairs office at the address below, or call, toll free:
GE Answer Center®
800.626.2000
consumer information service
- Improper installation.
If you have an installation problem, contact your dealer or installer.

You are responsible for providing adequate electrical, gas, exhausting and other connecting facilities as described in the Installation Instructions provided with the product.

- Replacement of house fuses or resetting of circuit breakers.
- Failure of the product if it is used for other than its intended purpose or used commercially.
- Damage to product caused by accident, fire, floods or acts of God.

WARRANTOR IS NOT RESPONSIBLE FOR CONSEQUENTIAL DAMAGES.

Some states do not allow the exclusion or limitation of incidental or consequential damages, so the above limitation or exclusion may not apply to you. This warranty gives you specific legal rights, and you may also have other rights which vary from state to state. To know what your legal rights are in your state, consult your local or state consumer affairs office or your state's Attorney General.

Warrantor: General Electric Company

**If further help is needed concerning this warranty, write:
Manager—Consumer Affairs, GE Appliances, Louisville, KY 40225**



Recycled Paper

Part No. 164D2966P217-1

Pub No. 49-8702-1

2-97 CG

JGRS14

Printed in LaFayette, GA

Free Manuals Download Website

<http://myh66.com>

<http://usermanuals.us>

<http://www.somanuals.com>

<http://www.4manuals.cc>

<http://www.manual-lib.com>

<http://www.404manual.com>

<http://www.luxmanual.com>

<http://aubethermostatmanual.com>

Golf course search by state

<http://golfingnear.com>

Email search by domain

<http://emailbydomain.com>

Auto manuals search

<http://auto.somanuals.com>

TV manuals search

<http://tv.somanuals.com>