



Use and Care Guide

Built-in Oven



Safety instructions.....3 4



Operating Instructions, Tips

Aluminum Foil.....4, 1 9, 23, 26,27

Features5

Oven13-32

Broiling, Broiling Guide27, 28

Control Panel6-8

Convection Cooking11-17

Convection Baking 12-14

Convection Roasting 1 5-17

Multi-Shelf Baking 12

Offset Shelf 10, 12, 16

Special Roasting Rack 15

Timed Convection Baking 13, 14

Clock and Timer7, 8

Light; Bulb Replacement 10, 35

Preheating 18,26,28

Probe 16,24, 25

Regular Baking1 7-19

Regular Roasting/Guide23, 26

Regular Roasting with the Probe.....24, 25

Regular Timed Baking20, 21

Self-Cleaning Instructions29 32

Shelves.....9, 10, 12, 16, 18,27,29, 32



Problem **Solver**37, 38

Thermostat Adjustment—

Do It Yourself.....22

More questions ?...call

GE Answer Center™ 800.626.2000



Care and Cleaning33-36

Broiler Pan and Grid33

Control Panel36

Oven Door.....34

Oven Shelves33

Probe3 5

Self-Cleaning Instructions2 g-32



Consumer Services39

Appliance Registration2

Important Phone Numbers.....39

Model and Serial No. Location2

Removal of Packaging Tape2

WarrantyBack Cover

GE Appliances

Models: **JKP16**
JKP17
JKP18

164D2966P124



HELP US HELP YOU...

Before using your oven, read this guide carefully.

It is intended to help you operate and maintain your new oven properly.

Keep it handy for answers to your questions.

If you don't understand something or need more help, call:

GE Answer **Center**[®]

800.626.2000

24 hours a day, 7 days a week

How to Remove Packaging Tape

To assure no damage is done to the finish of the product, the safest way to remove adhesive left from packaging tape on new appliances is an application of a household liquid dishwashing detergent, mineral oil or cooking oil. Apply with a soft cloth and allow to soak. Wipe dry and then apply an appliance polish to thoroughly clean and protect the surface.

NOTE: The plastic tape must be removed from the chrome trim on oven parts. It cannot be removed if it is baked on.

Write down the model and serial numbers.

You'll find them on a label on the front of the oven behind the oven door.

These numbers are also on the Consumer Product Ownership Registration Card that came with your oven. Before sending in this card, please write these numbers here:

Model Number

Serial Number

Use these numbers in any correspondence or service calls concerning your oven.

If you received a damaged oven...

Immediately contact the dealer (or builder) that sold you the oven.

Save time and money. Before you request service...

Check the Problem Solver in the back of this guide. It lists causes of minor operating problems that you can correct yourself.

IF YOU NEED SERVICE...

To obtain service, see the Consumer Services page in the back of this guide.

We're proud of our service and want you to be pleased. If for some reason you are not happy with the service you receive, here are three steps to follow for further help.

FIRST, contact the people who serviced your appliance. Explain why you are not pleased. In most cases, this will solve the problem.

NEXT, if you are still not pleased, write all the details—including your phone number—to:

Manager, Consumer Relations GE Appliances
Appliance Park
Louisville, KY 40225

FINALLY, if your problem is still not resolved, write:

Major Appliance Consumer Action Panel
20 North Wacker Drive
Chicago, IL 60606

IMPORTANT SAFETY INSTRUCTIONS

Read all instructions before using this appliance.



IMPORTANT SAFETY NOTICE

- **The California Safe Drinking Water and Toxic Enforcement Act** requires the Governor of California to publish a list of substances known to the state to cause birth defects or other reproductive harm, and requires businesses to warn customers of potential exposure to such substances.
- The fiberglass insulation in self-cleaning ovens gives off a very **small** amount of carbon monoxide during the cleaning cycle. Exposure can be minimized by venting with an open window or using a ventilation fan or hood.

When using electrical appliances, basic safety precautions should be followed, including the following:

- **Have** the installer show you the location of the circuit breaker or fuse. Mark it for easy reference.
- Use this appliance only for its intended use as described in this guide.
- **Be** sure your appliance is properly installed and grounded by a qualified technician in accordance with the provided Installation Instructions.
- Do not attempt to repair or replace any part of your oven unless it is specifically recommended in this guide. All other servicing should be referred to a qualified technician.
- Before performing any service, **DISCONNECT THE OVEN POWER SUPPLY AT THE HOUSEHOLD DISTRIBUTION PANEL BY REMOVING THE FUSE OR SWITCHING OFF THE CIRCUIT BREAKER.**
- Do not leave children alone—Children should not be left alone or unattended in an area where appliance is in use. They should never be allowed to sit or stand on any part of the appliance.
- Do not allow anyone to climb, stand or hang on the door. They could damage the oven or cause severe personal injury.
- **CAUTION: ITEMS OF INTEREST TO CHILDREN SHOULD NOT BE STORED IN CABINETS ABOVE AN OVEN. CHILDREN CLIMBING ON THE OVEN TO REACH ITEMS COULD BE SERIOUSLY INJURED.**

- Teach children not to play with the controls or any other part of the oven.
- Never leave the oven door open when you are not watching the oven.
- Always keep combustible **wall** coverings, curtains or drapes a safe distance from your oven.
- Never wear loose-fitting or hanging garments while using the **appliance**. Be careful when reaching for items stored in cabinets over the oven. Flammable material could be ignited if brought in contact with hot heating elements and may cause severe burns.
- **DO NOT STORE OR USE COMBUSTIBLE MATERIALS, GASOLINE OR OTHER FLAMMABLE VAPORS AND LIQUIDS IN THE VICINITY OF THIS OR ANY OTHER APPLIANCE.**



- Use only dry pot holders—Moist or damp pot holders on hot surfaces may result in burns from steam. Do not let pot holders touch hot heating elements. Do not use a towel or other bulky cloth. Such cloths can catch fire on a hot heating element.
- Always keep dish towels, dish cloths, pot holders and other linens a safe distance from your oven.
- Always keep wooden and plastic utensils and canned food a safe distance away from your oven.
- For your safety, never use your appliance for warming or heating the room.
- Do not store flammable materials in the oven.
- Do not let cooking grease or other flammable materials accumulate in or near the oven.
- Be sure the oven is securely installed **in** a cabinet that **is** firmly attached to the house structure. Never allow anyone to climb, sit, stand or hang on the oven door.

(continued next page)



IMPORTANT SAFETY INSTRUCTIONS

(continued)



- Do not **use water on grease** fires. Smother fire or flame or use a multi-purpose dry chemical or foam-type fire extinguisher.

Flame in the oven can be smothered completely by closing the oven door and turning the oven off or by using a multi-purpose dry chemical or foam-type fire extinguisher.

- Do not touch the heating elements or **the** interior surface of the oven. These surfaces may be hot enough to burn even though they are dark in color. During and after use, do not touch, or let clothing or other flammable materials contact any interior area of the oven; allow sufficient time for cooling first.

Potentially hot surfaces include the oven vent openings and surfaces near the openings, crevices around the oven door, the edges of the door window and metal trim parts above the door.

Remember: The inside surface of the oven may be hot when the door is opened.

- When cooking **pork**, follow the directions exactly and always cook the meat to an internal temperature of at least 170°F. This assures that, in the remote possibility that trichina may be present in the meat, it will be killed and the meat will be safe to eat.

Oven

- Stand away from the oven when opening the oven door. The hot air or steam which escapes can burn hands, face and/or eyes.
- Do not heat unopened food containers. Pressure could build up and the container could burst, causing an injury.
- Keep the oven vent duct unobstructed.
- Keep the oven free from grease **buildup**.
- Place the oven **shelf** in the desired position while the oven is cool. If the shelves must be handled when hot, do not let the pot holder contact the heating elements.
- Pulling out the shelf to the shelf stop is a convenience in lifting heavy foods. It is also a precaution against burns from touching the hot surfaces of the door or the oven walls.

- When using cooking or roasting bags in the oven, follow the manufacturer's directions.
- Do not use your oven to dry **newspapers**. If overheated, they can catch fire.
- Do not **leave** paper products, cooking utensils or food in the oven when not in use.
- After broiling, always take the broiler pan out of the oven and clean it. Leftover grease in the broiler pan can catch on fire the next time you use the pan.
- Never leave jars or **cans** of fat drippings on or near your oven.
- Do not use aluminum foil to line oven bottoms, except as suggested in this guide. Improper installation of aluminum foil may result in a risk of electric shock or fire.
- Do not use the oven for a storage area. Items stored in an oven can ignite.

Self-Cleaning Oven

- Do not clean the oven door gasket. The door gasket is essential for a good seal. Care should be taken not to rub, damage or move the gasket.
- Do not use oven cleaners. No commercial oven cleaner or oven liner protective coating of any kind should be used in or around any part of the oven. Residue from oven cleaners will damage the inside of the oven when the self-clean cycle is used.
- Clean only parts listed in this Use and Care Guide.
- Before self-cleaning the oven, remove the broiler pan, grid and other cookware.
- Be sure to wipe up excess spillage before starting the self-cleaning operation.
- If the self-cleaning mode malfunctions, turn the oven off and disconnect the power supply. Have it serviced by a qualified technician.

SAVE THESE
INSTRUCTIONS

FEATURES OF YOUR OVEN



Important Safety Instructions

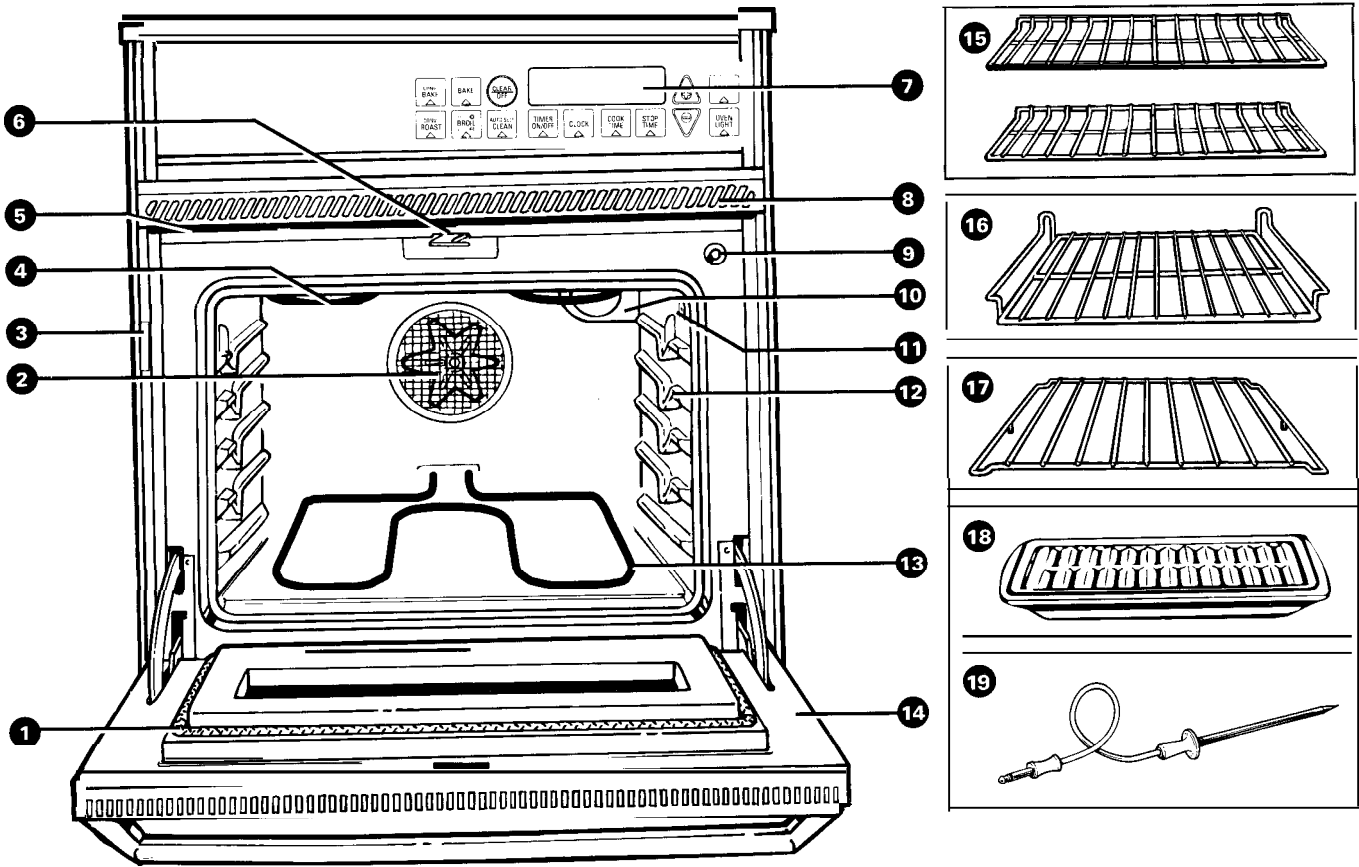

| Feature Index | Explained on page |
|---|-------------------|
| 1 OvenDoorGasket | 4,29,34 |
| 2 Convection Fan and Heating Element Operates during convection cooking. | 11-14,16 |
| 3 Model and Serial Numbers | 2 |
| 4 OvenBroil Element | 4,27,36 |
| 5 Oven Vent | 4 |
| 6 Automatic Oven Door Latch | 29-31 |
| 7 Oven Control, Clock and Timer | 6-8 |
| 8 Oven Vent Grille | 29 |
| 9 Automatic Oven Light Switch | 10 |
| 10 Oven Interior Light | 10,29,35 |
| 11 Probe Outlet | 16,24,25 |

| Feature Index | Explained on page |
|--|-------------------------------------|
| 12 Oven Shelf Supports Shelf positions for cooking are suggested in the Convection Cooking, Baking Roasting and Broiling sections. | 9, 10 , 12, 16, 18,27, 29,32 |
| 13 Bake Element Maybe lifted gently for wiping the oven floor. | 4,36 |
| 14 Lift-Off Oven Door with Broil Stop Position Easily removed for cleaning. | 34 |
| 15 Oven Shelves with Stop-Locks | 9, 10, 12, 16, 18,27, 29,32,33 |
| 16 Offset Shelf | 10, 12, 16,33 |
| 17 Roasting Rack | 15, 33 |
| 18 Broiler Pan and Grid | 15,24, 27-29,33 |
| 19 Probe | 16, 24, 25, 35 |

Features of Your Oven



FEATURES OF YOUR OVEN CONTROL

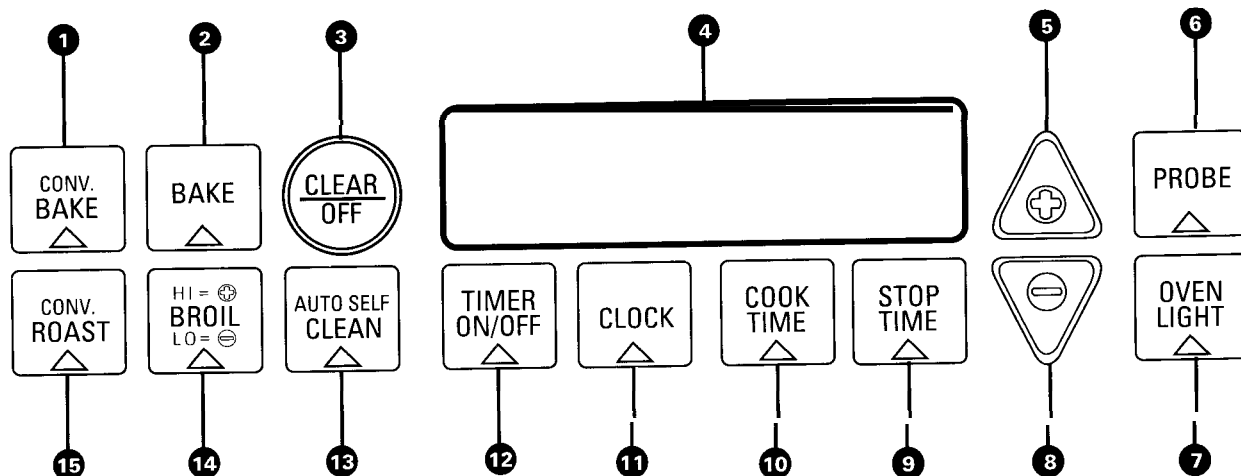

- 1. CONV. BAKE.** Press this pad to select baking with convection.
- 2. BAKE.** Press this pad to select the bake function.
- 3. CLEAR/OFF.** Press this pad to cancel all oven operations except clock and timer.
- 4. DISPLAY.** Shows the oven operations you have selected, the time of day and the cooking or cleaning status.
- 5. INCREASE.** Short taps to this pad increase the time or temperature by small amounts. Press and hold the pad to increase the time or temperature by larger amounts.
- 6. PROBE.** Press this pad when using the probe to cook food.
- 7. OVEN LIGHT.** Press this pad to turn the oven light on or off.
- 8. DECREASE.** Short taps to this pad decrease the time or temperature by small amounts. Press and hold the pad to decrease the time or temperature by larger amounts.
- 9. STOP TIME.** Use this pad along with the COOK TIME or AUTO SELF CLEAN pad to set the oven to start and stop automatically at a time you select.
- 10. COOK TIME.** Use this pad for Timed Bake, Timed Convection Bake and Timed Convection Roast operations.
- 11. CLOCK.** To set the clock, first press the CLOCK pad. Then press the INCREASE or DECREASE pad to set the time of day. Press the CLOCK pad to start.
- 12. TIMER ON/OFF.** Press this pad to select the timer function. The timer does not control oven operations. The timer can time up to 9 hours and 55 minutes.
To set the timer, first press the TIMER ON/OFF pad. Then press the INCREASE or DECREASE pad to change the time.
To cancel the timer, press and hold the TIMER ON/OFF pad until the word "TIMER" disappears from the display.
- 13. AUTO SELF CLEAN.** Press this pad to select the self-cleaning function. See the Operating the Self-Cleaning Oven section.
- 14. BROIL.** Press this pad to select the broil function.
- 15. CONV. ROAST.** Press this pad to select roasting with convection

If "F-and a number" flash in the display and the oven control signals, this indicates function error code. Press the CLEAR/OFF pad. Allow the oven to cool for one hour. Put the oven back into operation. If the function error code repeats, disconnect the power to the oven and call for service.

OVEN CONTROL, CLOCK AND TIMER



Lock

The clock must be set for the automatic oven timing functions to work properly. The time of day cannot be changed during a Timed Baking or Self-Cleaning cycle.

To Set the Clock

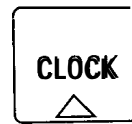

1. Press the CLOCK pad.



2. Press the INCREASE or DECREASE pad to set the time of day.

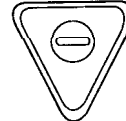

3. Press the CLOCK pad to start.

Timer

The timer is a minute timer; it does not control oven operations. The maximum setting on the timer is 9 hours and 55 minutes.

To Set the Timer



1. Press the TIMER ON/OFF pad.



2. Press the INCREASE or DECREASE pad to set the amount of time on the timer.

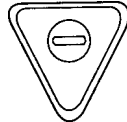

The timer will start automatically within a few seconds of releasing the INCREASE or DECREASE pad. The timer, as you are setting it, will display seconds until one minute is reached. Then it will display minutes and seconds until 60 minutes is reached.

After 60 minutes, it will display hours ("HR" now appears in display) and minutes until the maximum time of 9 hours and 55 minutes is reached.

To Reset the Timer

If "TIMER" is displayed, press the INCREASE or DECREASE pad until desired time is reached.

If "TIMER" is not displayed, press the TIMER ON/OFF pad first, then follow the instructions above to set the timer.

To Cancel the Timer

Press and hold the TIMER ON/OFF pad until the word "TIMER" disappears from the display.

End of Cycle Tone

The end of cycle tone is a series of three beeps followed by one beep every six seconds until you press any operation. If you would like to eliminate the repeating beeps, press and hold the CLEAR/OFF pad for 10 seconds.

To return the end of cycle tone to the repeating beeps, press and hold the CLEAR/OFF pad for 10 seconds.

Power Outage

After a power outage, when power is restored, the display will flash and time shown will no longer be correct—for example, after a 5-minute power interruption the clock will be 5 minutes slow. The display flashes until the clock is reset. All other functions that were in operation when the power went out will have to be programmed again.

(continued next page)



OVEN CONTROL, CLOCK AND TIMER

(continued)

Display Messages

Programmed information can be displayed at any time by pressing the pad of the operation you want to see. For example, you can display the current time of day while the timer is counting down by pressing the CLOCK pad. Press the TIMER ON/OFF pad to return to the timer display.

To check the start time for delayed Bake or Self-Clean, press and hold COOK TIME or AUTO SELF CLEAN pad for 3 seconds. The display will show the bake or clean start time for as long as you press the pad. When you release the pad, the display will return to the time of day.

- If “clean” appears in the display, DOOR flashes and the oven control signals, you set the self-clean cycle and did not shut the door.
- If “LOCK” only appears in the display, the oven door is in the locked position. BAKE, BROIL and COOK TIME cannot be set if the door is in the locked position.

INCREASE and DECREASE Pad Speed

You can change the speed of the INCREASE and DECREASE pads.

While the oven is off and the time of day shows in the display, press and hold the INCREASE and DECREASE pads and the TIMER ON/OFF pad at the same time for about 2 or 3 seconds.

A number from 1 to 5 will replace “0:00” in the display. The slowest is 1 and the fastest is 5. Use the INCREASE or DECREASE pad to change the number, then press the CLEAR/OFF pad to return to the time of day display.



Child Lockout Feature

Your built-in oven has a provision for locking the oven control to prevent the oven from being turned on accidentally.

To lock the oven control, press and hold the INCREASE and DECREASE pad and the STOP TIME pad at the same time for two seconds. The word “OFF” will appear and then disappear in the display and the oven control will be locked. During lockout, the word “OFF” will appear momentarily each time a cooking function pad is pressed.

To unlock the oven control, repeat the above procedure. The word “OFF” will appear in the display and then disappear after two seconds.

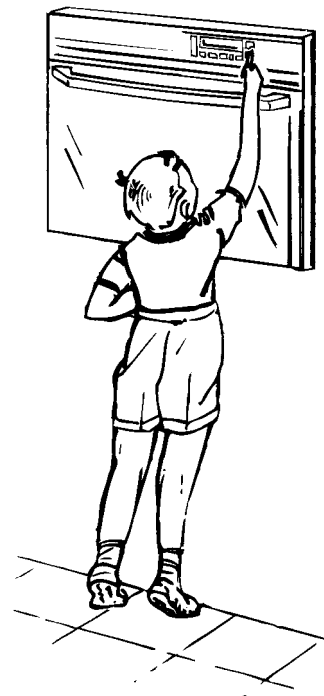

USING YOUR OVEN



Before Using Your Oven

1. Look at the controls. Be sure you understand how to set them properly.
2. Check the oven interior. Look at the shelves. Take a practice run at removing and replacing them properly to give sure, sturdy support.
3. Read over the information and tips that follow.
4. Keep this guide handy so you can refer to it, especially during the first weeks of using your new oven.

NOTE:

- You may notice a “burning” or “oily” smell the first few times you turn your oven on. This is normal in a new oven and will disappear in a short time. To speed the process, set a self-clean cycle for a minimum of 3 hours. See the Operating the Self-Cleaning Oven section.
- A fan may automatically turn on and off to cool internal parts. This is normal and the fan may continue to run even after the oven is turned off.
- You will hear a fan while cooking with the convection feature. The fan will stop when the door is opened, but the heat will not turn off.

Oven Shelves

The shelves are designed with stop-locks so that when placed correctly on the shelf supports, they will stop before coming completely out from the oven, and will not tilt when removing food from or placing food on them.

When placing cookware on a shelf, pull the shelf out until the bump on the shelf support. Place the cookware on the shelf, then slide the shelf back into the oven. This will eliminate reaching into the hot oven.

To remove the shelf from the oven, pull the shelf toward you, tilt the front end upward and pull the shelf out.

To replace, place the shelf on the shelf support with the stop-locks (curved extension of the shelf) facing up and toward the rear of the oven. Tilt up the front and push the shelf toward the back of the oven until it goes past the bump on the shelf support. Then lower the front of the shelf and push it all the way back.

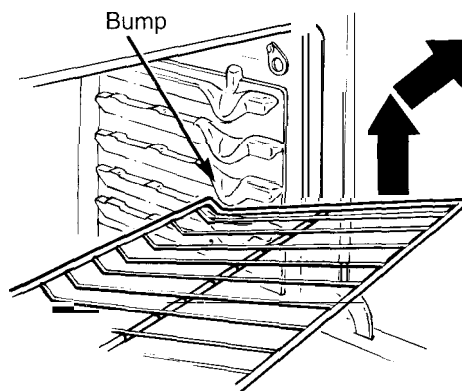

(continued next page)



USING YOUR OVEN

(continued)

Offset Shelf

The offset shelf provides more cooking space between itself and the shelf above it. This allows more flexibility when placing foods in the oven. See the Multi-Shelf Baking section.

The offset shelf can be placed at any shelf position.

CAUTION: When you are using the offset shelf in the lowest position (A), you will need to use caution when pulling the shelf out. We recommend that you pull the shelf out several inches and then, using two pot holders, pull the shelf out by holding the sides of it. The offset shelf is low and you could be burned if you place your hand in the middle of the shelf and pull all the way out.

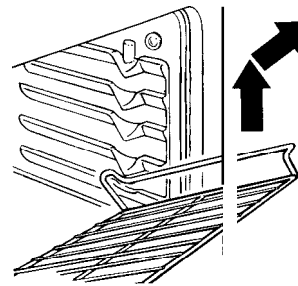
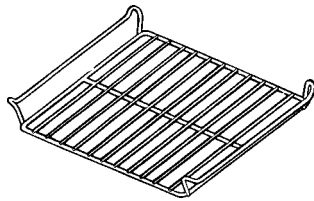

To remove the shelf, pull it forward to the stop-locks and lift the front of the shelf.

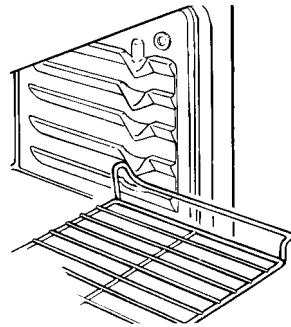

To replace the shelf, tilt the shelf up at the front and slide the curved extension of the shelf under the shelf supports. Then slide the shelf all the way into the oven.

Shelf Positions

The oven has 4 shelf supports identified in this illustration as A (bottom), B, C and D (top).

Shelf positions are suggested in the Baking, Roasting and Broiling sections.

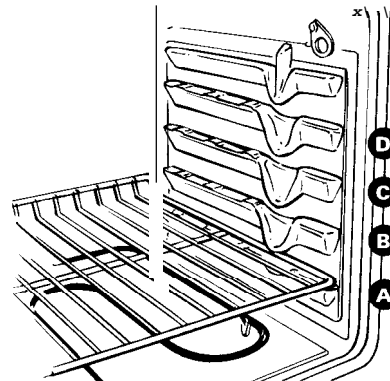

Oven Light

The light comes on automatically when the door is opened.

Use the pad on the control panel to turn the light on and off when the door is closed.



CONVECTION COOKING



What is Convection?

In a convection oven, a fan circulates hot air over, under and around the food. This circulating hot air is evenly distributed throughout the oven cavity. As a result, foods are evenly cooked and browned—often in less time with convection heat.

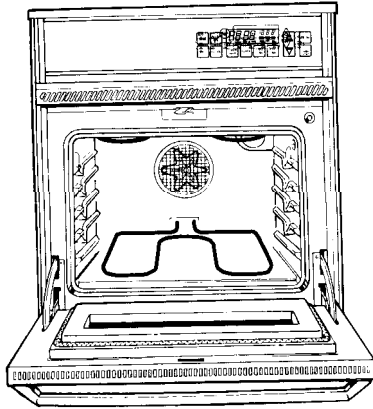

Because food is heated faster in a convection oven when using the convection modes, many types of food can be cooked at lower temperatures than those suggested for regular ovens. Do remember that recipe books often give times and temperatures for cooking in regular ovens. Convection ovens make it possible to reduce the temperature by 25°F. For more information on adapting recipes, see the Convection Cookbook.

CAUTION: The convection oven fan shuts off when the oven door is opened. **DO NOT** leave the door open for long periods of time while using convection cooking or you may shorten the life of the convection heating element.

When should you use Convection Bake or Convection Roast?

To help you understand the difference between convection bake and roast and traditional bake and roast, here are some general guidelines.

In convection bake, heat comes from the heating element in the rear of the oven. The convection fan circulates the heated air evenly over and around the food. Preheating is not necessary with foods having a bake time of over 15 minutes.

• In regular baking, the bottom oven element heats the air in the oven which then cooks the food.

Convection Bake

- Ideal for baked foods cooked on all 3 shelves.
- Good for large quantities of baked foods.
- Good results with cookies, biscuits, brownies, cream puffs, sweet rolls, angel food cake and bread.

Regular Bake

- Foods such as layer cakes have a more level top crust when not baked with convection heat.

In convection roast, heat comes from the top oven element. The convection fan circulates the heated air evenly over and around the food. Meat and poultry are browned on all sides as if they were cooked on a rotisserie. Using the roasting rack provided, heated air will be circulated over, under and around the food being roasted. The heated air seals in juices quickly for a moist and tender product while, at the same time, creating a rich golden brown exterior.

Convection Roast

- Large tender cuts of meat, uncovered.
- Roasting pans with low sides to allow air movement around food.

Regular Roast

- Less tender cuts of meat because these need to cook a long time in liquid to become tender.
- Cooking bag
- * Foil tent

Cookware for Convection Cooking

Before using your convection oven, check to see if your cookware leaves room for air circulation in the oven. If you are baking with several pans, leave space between them. Also, be sure the pans do not touch each other or the walls of the oven.

Metal and Glass

Any type of cookware will work in your convection oven. However, metal pans heat the fastest and are recommended for convection baking.

- Darkened or matte-finished pans will bake faster than shiny pans.

Glass or ceramic pans cook more slowly.

Paper and Plastic

Heat-resistant paper and plastic containers that are recommended for use in regular ovens can be used in convection ovens. Plastic cookware that is heat-resistant to temperatures of 400°F can also be used.

“When baking cookies, you will get the best results if you use a flat cookie sheet instead of a pan with low sides.

For recipes like oven-baked chicken, you should use a pan with low sides. Hot air cannot circulate well around food in a pan with high sides.



CONVECTION BAKING

Adapting Recipes for Convection Baking

As a general rule, reduce the temperature by 25°F. for Convection Baking. For more specific instructions, follow the guidelines in the Convection Cookbook.

Preheating is not necessary with foods having a bake time of over 15 minutes.

Check foods for doneness at the minimum suggested cooking time.

Use pan size recommended in the recipe.

For more information on adapting recipes, see the Convection Cookbook.

Multi-Shelf Baking

Because heated air is circulated evenly throughout the oven, foods can be baked with excellent results on two or three shelves at a time. Multi-shelf baking may increase cook times slightly for some foods but the overall result is time saved. Cookies, biscuits, and quickbreads give very good results with multi-shelf baking.

When baking on three shelves, divide the oven into thirds by placing the offset shelf in the third (C) shelf position and straight shelves in first (A) and fourth (D) shelf position.

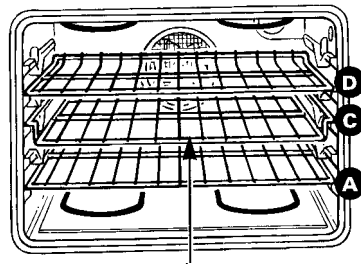

Offset Shelf

For 2-shelf baking, place the offset shelf in the bottom (A) shelf position. Place the straight shelf in the third (C) shelf position.

CAUTION: When you are using the offset shelf in the lowest position (A), you will need to use caution when pulling the shelf out. We recommend that you pull the shelf out several inches and then, using two pot holders, pull the shelf out by holding the sides of it. The offset shelf is low and you could be burned if you place your hand in the middle of the shelf and pull all the way out.

NOTE: When convection baking with only one shelf, follow the shelf positions recommended in Oven Shelves in the Regular Baking section.

How to Set Your Oven for Convection Baking

To avoid possible burns, place the shelves in the correct position before you turn the oven on.



1. Press the CONV. BAKE pad.



2. Press the INCREASE or DECREASE pad. The last oven temperature used appears in the display. Continue pressing until the desired temperature is displayed.

The oven will start automatically. The word "ON" and "100°7" will be displayed. As the oven heats up, the display will show the changing temperatures. When the oven reaches the temperature you have set a tone will sound.



3. Press the CLEAR/OFF pad when baking is finished.

NOTE:

- You will hear a fan while cooking with this feature. The fan will stop when the door is opened, but the heat will not turn off.
- A second fan may automatically turn on and off to cool internal parts. This is normal and the fan may continue to run even after the oven is turned off.

To change the oven temperature during the Convection Bake cycle, press the CONV. BAKE pad and then the INCREASE or DECREASE pad to get the new temperature.

TIMED CONVECTION BAKING



How to Convection Time Bake

The oven can be set to turn on and off automatically at specific times that you set. Examples of Immediate Start (oven turns on now and you set it to turn off automatically at a later time and turn off at a preset Stop Time) will be described.

NOTE: Before beginning, make sure the oven clock shows the correct time of day.



To set the clock, first press the CLOCK pad. Press the INCREASE or DECREASE pad until the correct time of day is displayed. Press the CLOCK pad to start.

How to Set Immediate Start and Automatic Stop Convection Bake

To avoid possible burns, place the oven shelves in the correct position before you turn the oven on.

You can set the oven control to delay-start the oven, cook for a specific length of time and then turn off automatically.

The oven will turn on immediately and cook for a specific length of time. At the end of Cook Time, the oven will turn off automatically.



1. Press the COOK TIME pad.

NOTE: If your recipe requires preheating, you may need to add additional time to the length of the Cook Time.



2. Press the INCREASE pad until the desired length of baking time appears in the display.



3. Press the CONV. BAKE pad.



4. Press the INCREASE or DECREASE pad until the desired temperature is displayed.

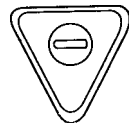

The words "TIMED CONV BAKE" and "COOK TIME" will be displayed along with the oven temperature that you set and the cook time that you entered. The oven will start automatically. The word "ON" and "100°" will be displayed. The Cook Time will begin to count down. As the oven heats up, the display will show the changing temperatures. When the oven reaches the temperature you set, a tone will sound. The oven will continue to cook for the programmed amount of time, then shut off automatically.

5. At the end of Timed Convection Bake, the display will show "0HR:00 COOK TIME" and the oven will turn off. The end of cycle tone will sound.



6. Press the CLEAR/OFF pad to clear the display if necessary. Remove the food from the oven. Remember, foods that are left in the oven continue cooking after the controls are off.

NOTE:

- You will hear a fan while cooking with this feature. The fan will stop when the door is opened but the heat will not turn off.
- A second fan may automatically turn on and off to cool internal parts. This is normal and the fan may continue to run even after the oven is turned off.
- Foods that spoil easily such as milk, eggs, fish, stuffings, poultry and pork should not be allowed to sit for more than one hour before or after cooking. Room temperature promotes the growth of harmful bacteria. Be sure that oven light is off because heat from the bulb will speed harmful bacteria growth.

(continued next page)



TIMED CONVECTION BAKING

(continued)

How to Set Delay Start and Automatic Stop Convection Bake

Quick Reminder:

1. Press the COOK TIME pad.
2. Press the INCREASE or DECREASE pad to set the length of baking time.
3. Press the STOP TIME pad.
4. Press the INCREASE or DECREASE pad until the desired Stop Time appears in the display.
5. Press the CONV. BAKE pad.
6. Press the INCREASE or DECREASE pad to select the oven temperature.

To avoid possible burns, place the shelves in the correct position before you program the oven.

You can set the oven control to delay-start the oven, cook for a specific length of time and then turn off automatically.



1. Press the COOK TIME pad.

NOTE: If your recipe requires preheating, you may need to add additional time to the length of the Cook Time.



2. Press the INCREASE pad until the desired length of baking time appears in the display.



3. Press the STOP TIME pad. "STOP TIME" and the earliest Stop Time you can set appear in the display.

The control automatically sets the Stop Time by adding the Cook Time to the time of day. For example, the time of day is 2:00 and the Cook Time is 3 hours. Adding 3 hours to the time of day equals 5:00.



4. Change Stop Time by pressing the INCREASE pad until the desired Stop Time appears in the display. The words "DELAY TIMED CONV BAKE" and "STOP TIME" appear in the display.



5. Press the CONV. BAKE pad.



6. Press the INCREASE or DECREASE pad until the desired temperature appears in the display.

The oven will turn on automatically. The word "ON" and "100°" will be displayed. The Cook Time will begin to count down. As the oven heats up, the display will show the changing temperatures. The oven will continue to cook for the programmed time and shut off automatically.

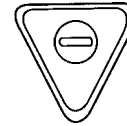

At the end of Timed Convection Bake, the display will show "0HR:00 COOK TIME" and the oven will turn off. The end of cycle tone will sound.



7. Press the CLEAR/OFF pad to clear the display if necessary. Remove the food from the oven. Remember, even though the oven shuts off automatically, foods continue cooking after the controls are off.

NOTE:

- You will hear a fan while cooking with this feature. The fan will stop when the door is opened but the heat will not turn off.
- A second fan may automatically turn on and off to cool internal parts. This is normal and the fan may continue to run even after the oven is turned off.
- Foods that spoil easily such as milk, eggs, fish, stuffings, poultry and pork should not be allowed to sit for more than one hour before or after cooking. Room temperature promotes the growth of harmful bacteria. Be sure that the oven light is off because heat from the bulb will speed harmful bacteria growth.

CONVECTION ROASTING



Meats cooked in a convection oven are dark brown on the outside and tender and juicy on the inside. In most cases, cooking time will be less when using the Convection Roast feature. Sometimes cooking time is reduced by 10 minutes per hour.

To make sure the meat is cooked the way you want it, we recommend using the temperature probe provided with the oven.

The special roasting rack and broiler pan allow heated air to circulate over and under the meat. This allows the meat to brown on all sides.

Adapting Recipes for Convection Roasting

Use the temperature recommended in the Convection Roasting Guide.

Preheating is not necessary.

Check foods for doneness at the minimum suggested time.

Use the special roasting rack with the broiler pan and grid.

For more information on adapting recipes, see the Convection Cookbook.

Convection Roasting Rack

Roasts or poultry should be cooked on the lowest shelf position (A) on the offset shelf.

When you are convection roasting you will use the broiler pan and grid and the special roasting rack. The pan is used to catch grease spills and the grid is used to prevent grease splatters. **The rack holds the meat.**

This rack allows the heated air to circulate under the meat and increase browning on the underside of the meat or poultry.

1. Place the offset shelf in the lowest shelf position (A).
2. Place the grid on the broiler pan and put the roasting rack over them making sure the posts on the roasting rack fit into the holes in the broiler pan.
3. Place the meat on the special roasting rack.

See the Regular Roasting with the Probe section to insert the probe correctly.

NOTE: It is important that the broiler pan and grid be used with the roasting rack for best convection roasting results.

CAUTION: When you are using the offset shelf in the lowest position (A), you will need to use caution when pulling the shelf out. We recommend that you pull the shelf out several inches and then, using two pot holders, pull the shelf out by holding the sides of it. The offset shelf is low and you could be burned if you place your hand in the middle of the shelf and pull all the way out.

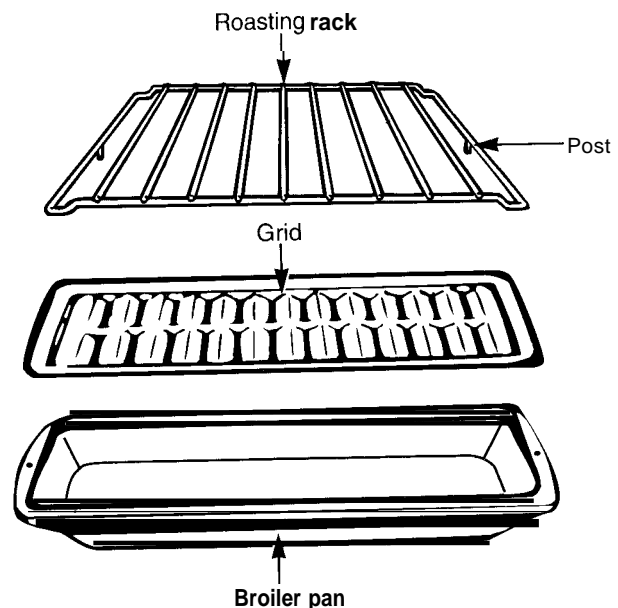

(continued next page)



CONVECTION ROASTING

(continued)

How to Set Your Oven for Convection Roasting When Using the Temperature Probe

NOTE: For best results when roasting large turkeys and roasts, we recommend using the probe included in the convection oven. For correct placement of the probe, see the description in the Regular Roasting section.

The display will flash “PROBE” and the oven control **will signal if the probe is inserted into the outlet, but the oven is not programmed for the probe.**

1. Place the offset shelf in the lowest position (A). Insert the probe into the meat.
2. Plug the probe into the outlet on the oven wall. Make sure it is pushed all the way in. Close the oven door.

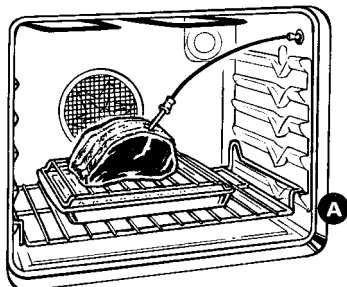

3. Press the CONV. ROAST pad.



4. Press the INCREASE or DECREASE pad. The last oven temperature used appears in the display. Continue pressing until the desired temperature is displayed.



5. Press the PROBE pad.

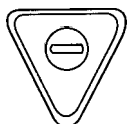

6. Press the INCREASE or DECREASE pad until the desired internal probe temperature is displayed.

The oven will start automatically. The words “CONV ON” and the roasting temperature you set will be in the display.

After a few seconds, the words “LO PROBE” will replace the roasting temperature in the display. After the internal temperature of the meat reaches 100°F., the changing internal temperature will be shown in the display.



7. When the internal temperature of the meat reaches the temperature you have set, the probe and the oven turn off and the oven control signals. To stop the signal, press the CLEAR/OFF pad. Use hot pads to remove the probe from the food. Do not use tongs to pull on it—they might damage it.

CAUTION: To prevent possible burns, do not unplug the probe from the oven outlet until the oven has cooled. Do not store the probe in the oven.

NOTE:

- You will hear a fan while cooking with this feature. The fan will stop when the door is opened but the heat will not turn off.
- A second fan may automatically turn on and off to cool internal parts. This is normal and the fan may continue to run even after the oven is turned off.
- You can use the timer even though you cannot use timed oven operations.

To change the oven temperature during the Convection Roast cycle, press the CONV. ROAST pad and then press the INCREASE or DECREASE pad to get the new desired temperature.

CONVECTION ROASTING GUIDE



| ats | | Minutes/Lb. | Oven Temperature (°F.) | Internal Temperature (°F.) | |
|------------------------------------|---|---|--|------------------------------|----------------------|
| Beef | Rib, Boneless Rib, Top Sirloin (3 to 5 lbs.) | Rare 20-24 Medium 24-28 Well 28-32 | 325° 325° 325° | 140°† 160° 170° | |
| | Beef Tenderloin | Rare 10-14 Medium 14-18 | 325° 325° | 140°† 160° | |
| | Pot Roast (2½ to 3 lbs.) | Chuck, Rump 35-45 | 300° | 170° | |
| | Pork | Bone-in, Boneless (3 to 5 lbs.) | 23-27 | 325° | 170° |
| | | Chops (1/2 to 1-inch thick) | 2 chops 30-35 total 4 chops 35-40 total 6 chops 40-45 total | 325° 325° 325° 325° | 170° 170° 170° |
| Ham | | Canned, Butt, Shank (3 to 5 lbs. fully cooked) | 14-18 | 325° | 140° |
| | | Lamb | Bone-in, Boneless (3 to 5 lbs.) Medium Well 17-20 20-24 | 325° 325° | 160° 170° |
| Seafood | Fish, whole (3 to 5 lbs.) | 30-40 total | 400° | | |
| | Lobster Tails (6 to 8 oz. each) | 20-25 total | 350° | | |
| Poultry | Whole Chicken (2½ to 3½ lbs.) | 24-26 | 350° | 180-185° | |
| | Cornish Hens | Unstuffed (1 to 1½ lbs.) | 50-55 total | 350° | 180-185° |
| | | Stuffed (1 to 1½ lbs.) | 55-60 total | 350° | 180-185° |
| | Duckling (4 to 5 lbs.) | 24-26 | 325° | 180-185° | |
| | Turkey, whole* | Unstuffed (10 to 16 lbs.) | 8-11 | 325° | 180-185° |
| | | Unstuffed (18 to 24 lbs.) | 7-10 | 325° | 180-185° |
| Turkey Breast (4 to 6 lbs.) | 16-19 | 325° | 170° | | |

*Stuffed birds generally require 30-45 minutes additional roasting time. Shield legs and breast with foil to prevent over browning and drying of skin.

†The U. S. Department of Agriculture says "Rare beef is popular, but you should know that cooking it to only 140°F. means some food poisoning organisms may survive." (Source: Safe Food Book, Your Kitchen Guide. USDA Rev. June 1985.)

REGULAR BAKING

Your oven temperature is controlled very accurately using an oven control system. We recommend that you operate the oven for a number of weeks to become familiar with your new oven's performance. If you think an adjustment is necessary, see the Adjust the Oven Thermostat section. It lists easy *Do It Yourself* instructions on how to adjust the thermostat.

NOTE: When the oven is hot, the front of the oven gets hot too.

How to Set Your Oven for Baking

To avoid possible burns, place the shelves in the correct position before you turn the oven on.



1. Press the BAKE pad.

2. Press the INCREASE or DECREASE pad. The last oven temperature used appears in the display. Continue pressing until the desired temperature is displayed.

The word "ON" and "100°" will be displayed. As the oven heats up, the display will show the changing temperatures. When the oven reaches the temperature you set, a tone will sound.



3. Press the CLEAR/OFF pad when baking is finished and then remove the food from the oven.

NOTE: A fan may automatically turn on and off to cool internal parts. This is normal and the fan may "continue to run even after the oven is turned off."

To change the oven temperature during the BAKE cycle, press the BAKE pad and then the INCREASE or DECREASE pad to get the new temperature.

(continued next page)



REGULAR BAKING

(continued)

Oven Shelves

Arrange the oven shelf or shelves in the desired locations while the oven is cool. The correct shelf position depends on the kind of food and the browning desired.

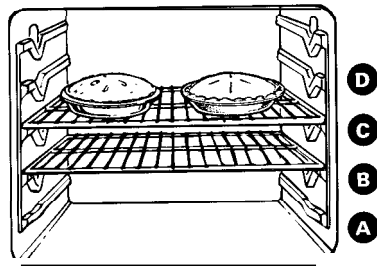

As a general rule, place most foods in the middle of the oven, on either shelf positions B or C. See the chart for suggested shelf positions.

| Type of Food | Shelf Position |
|----------------------|---------------------|
| Angel food cake | A |
| Biscuits or muffins | B or C |
| Cookies or cupcakes | B or C |
| Brownies | B or C |
| Layer cakes | B or C |
| Bundt or pound cakes | A or B |
| Pies or pie shells | B or C |
| Frozen pies | A (on cookie sheet) |
| Casseroles | B or C |
| Roasting | A or B |

Preheating

Preheat the oven if the recipe calls for it. Preheat means bringing the oven up to the specified temperature before putting the food in the oven. To preheat, set the oven at the correct temperature—selecting a higher temperature does not shorten preheat time.

Preheating is necessary for good results when baking cakes, cookies, pastry and breads. For most casseroles and roasts, preheating is not necessary. For ovens without a preheat indicator light or tone, preheat 10 minutes. After the oven is preheated, place the food in the oven as quickly as possible to prevent heat from escaping.

Baking Pans

Use the proper baking pan. The type of finish on the pan determines the amount of browning that will occur.

- Dark, rough or dull pans absorb heat, resulting in a browner, crisper crust. Use this type for pies.
- Shiny, bright and smooth pans reflect heat, resulting in a lighter, more delicate browning. Cakes and cookies require this type of pan.
- Glass baking dishes also absorb heat. When baking in glass baking dishes, the temperature may need to be reduced by 25°F.

Pan Placement

For even cooking and proper browning, there must be enough room for air circulation in the oven. Baking results will be better if baking pans are centered as much as possible rather than being placed to the front or to the back of the oven.

Pans should not touch each other or the walls of the oven. Allow 1- to 1 X-inch space between pans as well as from the back of the oven, the door and the sides. If you need to use two shelves, stagger the pans so one is not directly above the other.



Baking Guides

When using prepared baking mixes, follow package recipe or instructions for the best baking results.

Cookies

When baking cookies, flat cookie sheets (without sides) produce better-looking cookies. Cookies baked in a jelly roll pan (short sides all around) may have darker edges and pale or light browning may occur.

Do not use a cookie sheet so large that it touches the walls or the door of the oven. Never entirely cover a shelf with a large cookie sheet.

For best results during regular baking, use only one cookie sheet in the oven at a time.

Also see the Multi-Shelf baking section.

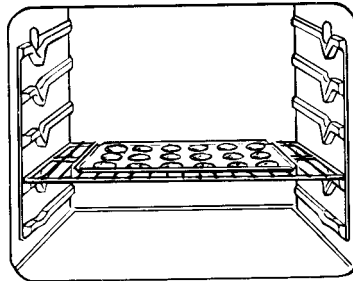

Pies

For best results, bake pies in dark, rough or dull pans, to produce a browner, crisper crust. Frozen pies in foil pans should be placed on an aluminum cookie sheet

... baking since the shiny foil pan reflects heat away from the pie crust; the cookie sheet helps retain it.

Cakes

When baking cakes, warped or bent pans will cause uneven baking results and poorly shaped products. A cake baked in a pan larger than the recipe recommended will usually be crisper, thinner and drier than it should be. If baked in a pan smaller than recommended, it may be undercooked and batter may overflow. Check the recipe to make sure the pan size used is the one recommended.

Aluminum Foil

Never cover a shelf entirely with aluminum foil. This will disturb the heat circulation and result in poor baking. A smaller sheet of foil may be used to catch a spillover by placing it on a lower shelf several inches below the food.

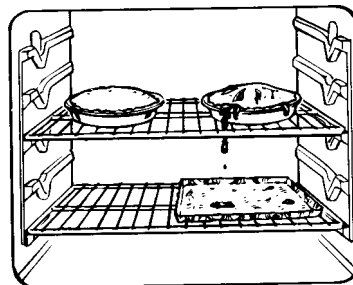

Don't Peek

Set the timer for the estimated cooking time and do not open the door to look at your food. Most recipes provide minimum and maximum baking times such as "bake 30-40 minutes."

DO NOT open the door to check until the minimum time. Opening the oven door frequently during cooking allows heat to escape and makes baking times longer. Your baking results may also be affected.



REGULAR TIMED BAKING

How to Time Bake

The oven can be set to turn on and off automatically at specific times that you set. Examples of Immediate Start (oven turns on now and you set it to turn off automatically) and Delay Start and Stop (setting the oven to turn on automatically at a later time and turn off at a preset Stop Time) will be described.

NOTE: Before beginning, make sure the oven clock shows the correct time of day.



To set the clock, first press the **CLOCK** pad. Press the **INCREASE** or **DECREASE** pad until the correct time of day is displayed. Press the **CLOCK** pad to start.

How to Set Immediate Start and Automatic Stop

To avoid possible burns, place the shelves in the correct position before you turn the oven on.

The oven will turn on immediately and cook for a selected length of time. At the end of Cook Time, the oven will turn off automatically.

The oven will start automatically. The word "ON" and "100°" will be displayed. The Cook Time will begin to count down. As the oven heats up, the display will show the changing temperature. When the oven reaches the temperature you set, a tone will sound. The oven will continue to cook for the programmed amount of time, then shut off automatically.

At the end of Timed Bake, the display will show "0HR:00 COOK TIME" and the oven will turn off. The end of cycle tone will sound.



1. Press the **COOK TIME** pad.

NOTE: If your recipe requires preheating, you may need to add additional time to the length of the Cook Time.



2. Press the **INCREASE** pad until the desired length of baking time appears in the display.



3. Press the **BAKE** pad.



4. Press the **INCREASE** or **DECREASE** pad until the desired temperature is displayed. An attention tone will sound if step 3 is not done.



The words "TIME BAKE" and "COOK TIME" will be displayed along with the oven temperature that you set and the Cook Time that you entered.



5. Press the **CLEAR/OFF** pad to clear the display if necessary. Remove the food from the oven. Remember, even though the oven shuts off automatically, foods continue cooking after the controls are off.

NOTE:

- Foods that spoil easily, such as milk, eggs, fish, stuffings, poultry and pork, should not be allowed to sit for more than one hour before or after cooking. Room temperature promotes the growth of harmful bacteria. Be sure that the oven light is off because heat from the bulb will speed harmful bacteria growth.
- A fan may automatically turn on and off to cool internal parts. This is normal, and the fan may continue to run after the oven is turned off.



How to Set Delay Start and Automatic Stop

Quick Reminder:

1. Press the COOK TIME pad.
2. Press the INCREASE/DECREASE pad to set the length of baking time.
3. Press the STOP TIME pad.
4. Press the INCREASE/DECREASE pad until the desired Stop Time appears in the display.
5. Press the BAKE pad.
6. Press the INCREASE/DECREASE pad to select an oven temperature.

To avoid possible burns, place the shelves in the correct position before you turn the oven on.

You can set the oven control to delay-start the oven, cook for a specific length of time and then turn off automatically.



1. Press the COOK TIME pad.

NOTE: If your recipe requires preheating, you may need to add additional time to the Cook Time.



2. Press the INCREASE pad until the desired length of baking time appears in the display.



3. Press the STOP TIME pad. "STOP TIME" and the earliest Stop Time you can set appear in the display.

The control automatically sets the Stop Time by adding the Cook Time to the time of day. For example, the time of day is 2:00 and the Cook Time is 3 hours. Adding 3 hours to the time of day equals 5:00.

4. Change the Stop Time by pressing the INCREASE pad until the desired Stop Time appears in the display.



5. Press the BAKE pad.



6. Press the INCREASE or DECREASE pad until the desired temperature is displayed.

The oven will turn on automatically. The word "ON" and "100°" will be displayed. The Cook Time will begin to count down. As the oven heats up, the display will show the changing temperature. The oven will continue to cook for the programmed time and shut off automatically.

At the end of Timed Bake, the display will show "0HR:00 COOK TIME" and the oven will turn off. The end of cycle tone will sound.



7. Press the CLEAR/OFF pad to clear the display if necessary. Remove the food from the oven. Remember, even though the oven shuts off automatically, foods continue cooking after the controls are off.

NOTE:

- Foods that spoil easily, such as milk, eggs, fish, stuffings, poultry and pork, should not be allowed to sit for more than one hour before or after cooking. Room temperature promotes the growth of harmful bacteria. Be sure the oven light is off because heat from the bulb will speed harmful bacteria growth.
- A fan may automatically turn on and off to cool internal parts. This is normal, and the fan may continue to run after the oven is turned off.



ADJUST THE OVEN THERMOSTAT— *DO IT YOURSELF!*

You may find that your new oven cooks differently than the one it replaced. We recommend that you use your new oven for a few weeks to become more familiar with it, following the times given in your recipes as a guide.

If you think your new oven is too hot or too cold, you can adjust the thermostat yourself. If you think it is too hot, adjust the thermostat to make it cooler. If you think it is too cool, adjust the thermostat to make it hotter.

We do not recommend the use of inexpensive thermometers, such as those found in grocery stores, to check the temperature setting of your new oven. These thermometers may vary 20–40 degrees.

The thermostat adjustment for Bake does not affect Convection Bake or Convection Roast. To adjust these, press the CONVECTION BAKE or the CONVECTION ROAST pad instead of the BAKE pad when following the steps under To Adjust the Thermostat.

To Adjust the Thermostat:



1. Press the BAKE pad.

2. Select an oven temperature between 500°F and 550°F.

3. Immediately, before “ON” is displayed, press and hold the BAKE pad for about 4 seconds. The time display will change to the oven adjustment display.

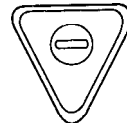

4. The oven temperature can be adjusted up to (+)35°F hotter or (–)35°F cooler. Use the INCREASE or DECREASE pad to select the desired change in the display.



5. When you have made the adjustment, press the CLEAR/OFF pad to go back to the time of day display. Use your oven as you would normally.

NOTE: This adjustment will not affect the broiling or self-cleaning temperatures. It will be retained in memory after a power failure.

REGULAR ROASTING



Roasting is cooking by dry heat. Tender meat or poultry can be roasted uncovered in your oven. Roasting temperatures, which should be low and steady, keep spattering to a minimum.

Roasting is really a baking procedure used for meats. Therefore, the oven controls are set for Baking or Timed Baking. (You may hear a slight clicking sound, indicating the oven is working properly.) Timed Baking will turn the oven on and off automatically.

Most meats continue to cook slightly while standing, after being removed from the oven. The standing time recommended for roasts is 10 to 20 minutes. This allows roasts to firm up and makes them easier to carve. The internal temperature will rise about 5° to 10°F.; to compensate for the temperature rise, if desired, remove the roast from the oven sooner (at 5° to 10°F. less than the temperature in the Regular Roasting Guide).

Remember that food will continue to cook in the hot oven and therefore should be removed when the desired internal temperature has been reached.

1. Place the shelf in A or B position. No preheating is necessary.
2. Check the weight of the meat. Place it fat side up (or for poultry breast-side-up) on a roasting rack in a shallow pan. The melting fat will baste the meat. Select a pan as close to the size of the meat as possible. (The broiler pan with grid is a good pan for this.)



3. Press the BAKE pad.



4. Press the INCREASE or DECREASE pad. The last oven temperature used appears in the display. Continue pressing the pad until the desired temperature is displayed.



The oven will start automatically. The word "ON" and "1000" will be displayed. As the oven heats up, the display will show the changing temperatures. When the oven reaches the temperature you set, a tone will sound.



5. Press the CLEAR/OFF pad when roasting is finished.

NOTE: A fan may automatically turn on and off to cool internal parts. This is normal and the fan may continue to run even after the oven is turned off.

To change the oven temperature during roasting, press the BAKE pad and then the INCREASE or DECREASE pad to get the new temperature.

Use of Aluminum Foil

You can use aluminum foil to line the broiler pan. This makes clean-up easier when using the pan for marinating, cooking with fruits, cooking heavily cured meats or basting food during cooking. Press the foil tightly around the inside of the pan.

(continued next page)

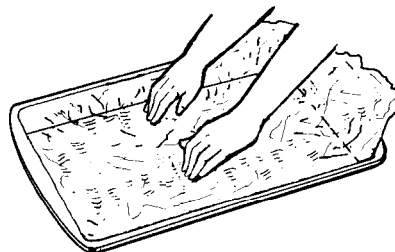



REGULAR ROASTING WITH THE PROBE

See the Regular Roasting Guide.

Correct Placement of the Temperature Probe

A temperature probe has been provided for use in your new oven. This probe is designed to withstand high temperatures. Temperature probes provided with other products, such as those used for microwave ovens, may not be designed to withstand high temperatures. Use of probes other than the one provided with this product may result in damage to the probe.

Never leave your probe inside the oven during a self-cleaning cycle.

For many foods, especially roasts and poultry, internal food temperature is the best test for doneness. The temperature probe takes the guesswork out of roasting by cooking foods to the exact doneness you want. When the internal temperature of the food reaches the temperature you set, the oven automatically shuts off.

The temperature probe has a skewer-like probe at one end and a plug at the other end that goes into the outlet on the oven wall.

Use the handles of the probe and plug when inserting and removing them from the meat and wall outlet. Do not use tongs to pull on the cable when removing the probe—they might damage it. **TO AVOID BREAKING THE PROBE, MAKE SURE FOOD IS COMPLETELY DEFROSTED BEFORE INSERTING.**

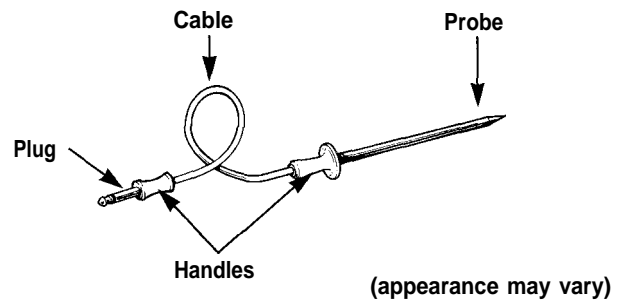

After preparing the meat and placing it on a trivet or on the broiler pan grid, follow these directions for proper probe placement.

1. Lay the probe on the outside of the meat along the top or side and mark with your finger where the edge of the meat comes to on the probe. The point should rest in the center of the thickest meaty part of the roast.

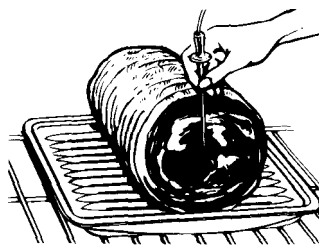

2. Insert the probe into the meat up to the point marked off with your finger. It should not touch the bone, fat or gristle.

No more than 2 inches of the probe, not counting the handle, should be left exposed outside the meat.

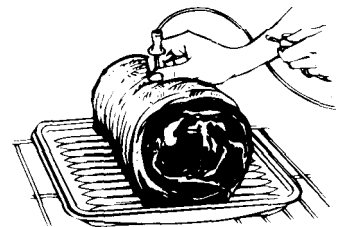

Ham or Lamb

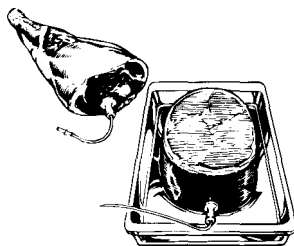

For roasts with no bone, insert the probe into the meatiest part of the roast. For bone-in ham or lamb, insert the probe into the center of the lowest large muscle or joint.

Casseroles or Fish

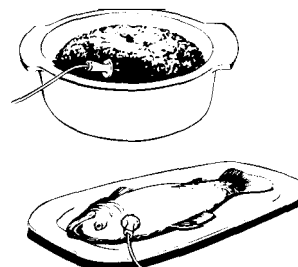

Insert the probe into the center of dishes such as meat loaf or casseroles. When cooking fish, insert the probe from just above the gill into the meatiest area, parallel to the backbone.

Poultry

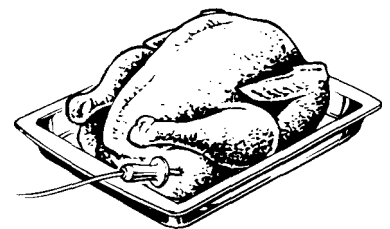

Insert the probe into the meatiest part of the inner thigh from below and parallel to the leg of a whole turkey.



How to Set the Oven When Using the Temperature Probe

The display will flash "PROBE" and the oven control will signal if the probe is inserted into the outlet but the oven is not programmed for the probe.

1. Insert the probe into the meat.
2. Plug the probe into the outlet on the oven wall. Make sure it's pushed all the way in. Close the oven door.

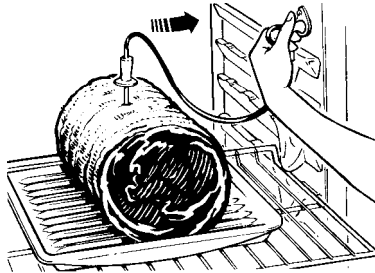

7. When the internal temperature of the meat reaches the number you have set, the probe and the oven turn off and the oven control signals. To stop the signal, press the CLEAR/OFF pad. Use hotpads to remove the probe from the food. Do not use tongs to pull on it—they might damage it.

CAUTION: To prevent possible burns, do not unplug the probe from the outlet until the oven has cooled. Do not store the probe in the oven.

NOTE:

- A fan may automatically turn on and off to cool internal parts. This is normal and the fan may continue to run even after the oven is turned off.
- You can use the timer even though you cannot use timed oven operations.

To change the oven temperature during the roast cycle, press the BAKE pad and then the INCREASE or DECREASE pad to get the new temperature.

(continued next page)

3. Press the BAKE pad.



4. Press the INCREASE or DECREASE pad. The last oven temperature used appears in the display. Continue pressing the pad until the desired oven temperature is displayed.



5. Press the PROBE pad.

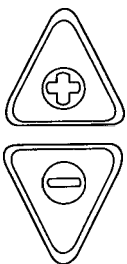

6. Press the INCREASE or DECREASE pad until the desired internal probe temperature is displayed.

The oven will start automatically. The words "BAKE ON" and the roasting temperature you set will be in the display.

After a few seconds, the words "LO PROBE" will replace the roasting temperature in the display. After the internal temperature of the meat reaches 100°F., the changing internal temperature will be shown in the display.



REGULAR ROASTING

(continued)

Regular Roasting Questions & Answers

Q. Is it necessary to check for doneness with a meat thermometer?

A. Checking the finished internal temperature at the completion of cooking time is recommended if you did not use the probe while cooking. Temperatures are shown in the Regular Roasting Guide. For roasts over 8 lbs., check with thermometer at half-hour intervals after half the cooking time has passed.

Q. Why is my roast crumbling when I try to carve it?

A. Roasts are easier to slice if allowed to cool 10 to 20 minutes after removing them from the oven. Be sure to cut across the grain of the meat.

Q. Do I need to preheat my oven each time I cook a roast or poultry?

A. It is not necessary to preheat your oven.

Q. When buying a roast, are there any special tips that would help me cook it more evenly?

A. Yes. Buy a roast as even in thickness as possible, or buy rolled roasts.

Q. Can I seal the sides of my foil "tent" when roasting a turkey?

A. Sealing the foil will steam the meat. Leaving it unsealed allows the air to circulate and brown the meat.

REGULAR ROASTING GUIDE

Frozen Roasts

Frozen roasts of beef, pork, lamb, etc., can be started without thawing, but allow 10 to 25 minutes per pound additional time (10 minutes per pound for roasts under 5 pounds, more time for larger roasts).

Make sure poultry is thawed before roasting. Unthawed poultry often does not cook evenly. Some commercial frozen poultry can be cooked successfully without thawing. Follow the directions given on the package label.

| Type | Oven Temperature | Doneness | Approximate Roasting Time in Minutes per Pound | | Internal Temperature °F. |
|--|------------------|--------------------------------|--|--|--------------------------------------|
| Meat | | | | | |
| Tender cuts; rib, high quality sirloin tip, rump or top round* | 325° | Rare: Medium: Well Done: | 3 to 5 lbs. 24-33 35-39 40-45 | 6 to 8 lbs. 18-22 22-29 30-35 | 140°-150°† 150°-160° 170°-185° |
| Lamb leg or bone-in shoulder* | 325° | Rare: Medium: Well Done: | 21-25 25-30 30-35 | 20-23 24-28 28-33 | 140°-150°† 150°-160° 170°-185° |
| Veal shoulder, leg or loin* | 325° | Well Done: | 35-45 | 30-40 | 170°-180° |
| Pork loin, rib or shoulder* | 325° | Well Done: | 35-45 | 30-40 | [700] 800 |
| Ham, precooked | 325° | To Warm: | 17-20 minutes per pound (any weight) | | 115°-120° |
| Poultry | | | | | |
| Chicken or Duck | 325° | Well Done: | 3 to 5 lbs. 35-40 | Over 5 lbs. 30-35 | 185°-190° |
| Chicken pieces | 350° | Well Done: | 35-40 | | 185°-190° |
| Turkey | 325° | Well Done: | 10 to 15 lbs. 18-25 | Over 15 lbs. 15-20 | In thigh: 185°-190° |

*For boneless rolled roasts over 6 inches thick, add 5 to 10 minutes per pound to times given above.

†The U. S. Department of Agriculture says "Rare beef is popular, but you should know that cooking it to only 140°F. means some food poisoning organisms may survive." (Source: Safe Food Book. Your Kitchen Guide. USDA Rev. June 1985.)

BROILING



Broiling is cooking food by intense radiant heat from the upper broil element in the oven. Most fish and tender cuts of meat can be broiled. Follow these directions to keep spattering and smoking to a minimum.

Turn the food using tongs only once during broiling. Time the foods for the first side according to the Broiling Guide.

Turn the food, then use the times given for the second side as a guide to the preferred doneness.

1. If the meat has fat or gristle around the edge, cut vertical slashes through both about 2 inches apart. If desired, the fat may be trimmed, leaving a layer about 1/8 inch thick.
2. Place the meat on the broiler grid in the broiler pan. Always use the grid so the fat drips into the broiler pan; otherwise the juices may become hot enough to catch on fire.
3. Position a flat shelf on the recommended shelf position as suggested in the Broiling Guide. Most broiling is done on C position, **but if your oven is connected to 208 volts, you may wish to use a higher position.**

4. Leave the door open to broil stop position. The door stays open by itself, yet the proper temperature is maintained in the oven.

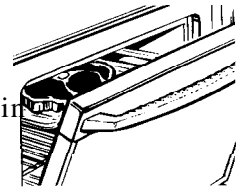

5. Press the BROIL pad.
6. Press the INCREASE pad for HI Broil or press the DECREASE pad for LO Broil.
To change from HI Broil to LO Broil, press the DECREASE pad once.
7. When broiling is finished press the CLEAR/OFF pad. Serve the food immediately, and leave the pan outside the oven to cool during the meal for easiest cleaning.

NOTE: A fan may automatically turn on and off to cool internal parts. This is normal and the fan may continue to run even after the oven is turned off.

Use of Aluminum Foil

You can use aluminum foil to line your broiler pan and broiler grid. However, you must mold the foil tightly to the grid and cut slits in it just like the grid.

Without the slits, the foil will prevent fat and meat juices from draining into the broiler pan. The juices could become hot enough to catch on fire. If you do not cut the slits, you are frying, not broiling.

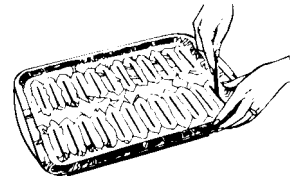

Questions and Answers

Q. Should I salt the meat before broiling?

A. **No.** Salt draws out the juices and allows them to evaporate. Always salt after cooking. Piercing the meat with a fork also allows the juices to escape. Turn the meat with tongs instead of a fork.

Q. Why are my meats not turning out as brown as they should?

A. In some areas, the power (voltage) to the oven may be low. In these cases, preheat the broil element for 10 minutes before placing broiler pan with food in the oven. Check to see if you are using the recommended shelf position. Broil for the longest period of time indicated in the Broiling Guide. Turn the food only once during broiling. You may need to move the food to a higher shelf position.

Q. Do I need to grease my broiler grid to prevent meat from sticking?

A. **No.** The broiler grid is designed to reflect broiler heat, thus keeping the surface cool enough to prevent meat from sticking to the surface. However, spraying the broiler grid lightly with a vegetable cooking spray before cooking will make clean-up easier.

Q. When broiling, is it necessary to always use a grid in the pan?

A. **Yes.** Using the grid suspends the meat over the pan. As the meat cooks, the juices fall into the pan, thus keeping meat drier. Juices are protected by the grid and stay cooler, thus preventing excessive spatter and smoking.



BROILING GUIDE

- Always use the broiler pan and grid that comes with your oven. It is designed to minimize smoking and spattering by trapping juices in the shielded lower part of the pan.
- **The oven door should be open to the broil stop position.**
- For steaks and chops, slash fat evenly around the outside edges of the meat. To slash, cut crosswise through the outer fat surface just to the edge of the meat. Use tongs to turn meat over to prevent piercing the meat and losing juices.
- If desired, marinate meats or chicken before broiling, or brush with barbecue sauce last 5 to 10 minutes only.
- When arranging food on the pan, do not let fatty edges hang over the sides because dripping fat could soil the oven.
- The broiler does not need to be preheated. However, for very thin foods, or to increase browning, preheat if desired.
- Frozen steaks can be broiled by positioning the oven shelf at next lowest shelf position and increasing cooking time given in this guide 1 ½ times per side.
- Use LO Broil to cook foods such as poultry or thick pork chops thoroughly without over-browning them.
- If your oven is connected to 208 volts, rare steaks may be broiled by preheating the broiler and positioning the oven shelf one position higher.

| Food | Quantity and/or Thickness | Shelf Position | First Side Time, Minutes | Second Side Time, Minutes | Comments |
|--|--|----------------|--------------------------|---------------------------|--|
| Bacon | 1/2 lb. (about 8 thin slices) | C | 4½ | 4½ | Arrange in single layer. |
| Ground Beef Well Done | 1 lb. (4 patties) 1/2 to 3/4 inch thick | C | 10 | 7 | Space evenly. Up to 8 patties take about same time. |
| Beef Steaks | | | | | |
| Rare | 1 inch thick | C | 6 | 5 | Steaks less than 1 inch thick cook through before browning. Pan frying is recommended. |
| Medium | (1 to 1 ½ lbs.) | C | 8 | 6 | |
| Well Done | | C | 12 | 11 | |
| Rare | 1½ inch thick | C | 10 | 7-8 | Slash fat. |
| Medium | (2 to 2½ lbs.) | C | 15 | 14-16 | |
| Well Done | | C | 25 | 20-25 | |
| Chicken | 1 whole (2 to 2½ lbs.), split lengthwise | A | 35 | 10-15 | Reduce time about 5 to 10 minutes per side for cut-up chicken. Brush each side with melted butter. Broil skin-side-down first. |
| Bakery Products | | | | | |
| Bread (Toast) or Toaster Pastries | 2 to 4 slices | C or D | 1½-2 | 1/2 | Space evenly. Place English muffins cut-side-up and brush with butter, if desired. |
| English Muffins | 1 pkg. (2) 2 (split) | C or D | 3-4 | | |
| Lobster Tails | 2-4 (6 to 8 oz. each) | B | 13-16 | Do not turn over. | Cut through back of shell. Spread open. Brush with melted butter before broiling and after half of broiling time. |
| Fish | 1-lb. fillets 1/4 to 1/2 inch thick | C | 5 | 5 | Handle and turn very carefully. Brush with lemon butter before and during cooking, if desired. Preheat broiler to increase browning. |
| Ham Slices (precooked) | 1 inch thick | B | 8 | 8 | Increase time 5 to 10 minutes per side for 1 ½ inch thick or home cured ham. |
| Pork Chops | 2 (1/2 inch thick) | C | 10 | 10 | Slash fat. |
| Well Done | 2(1 inch thick), about 1 lb. | B | 13 | 13 | |
| Lamb Chops | | | | | |
| Medium | 2 (1 inch thick), about 10 to 12 oz. | C | 10 | 9 | Slash fat. |
| Well Done | | C | 12 | 10 | |
| Medium | 2 (1 ½ inch thick), about 1 lb. | C | 14 | 12 | |
| Well Done | | B | 17 | 12-14 | |
| Wieners and similar precooked sausages, bratwurst | 1-lb. pkg. (10) | C | 6 | 1-2 | If desired, split sausages in half lengthwise; cut into 5-to 6-inch pieces. |

OPERATING THE SELF-CLEANING OVEN

Normal Cleaning Time: 3 hours



Prepare a Clean Cycle

1. Remove the broiler pan, broiler grid, all cookware and any aluminum foil from the oven—they can't withstand the high cleaning temperatures.

NOTE: The oven shelves may be cleaned in the self-cleaning oven. However, they will darken, lose their luster and become hard to slide. Wipe the shelf supports with cooking oil after self-cleaning to make shelves slide more easily.

2. Wipe up heavy soil on the oven bottom. If you use soap, rinse thoroughly before self-cleaning to prevent staining.

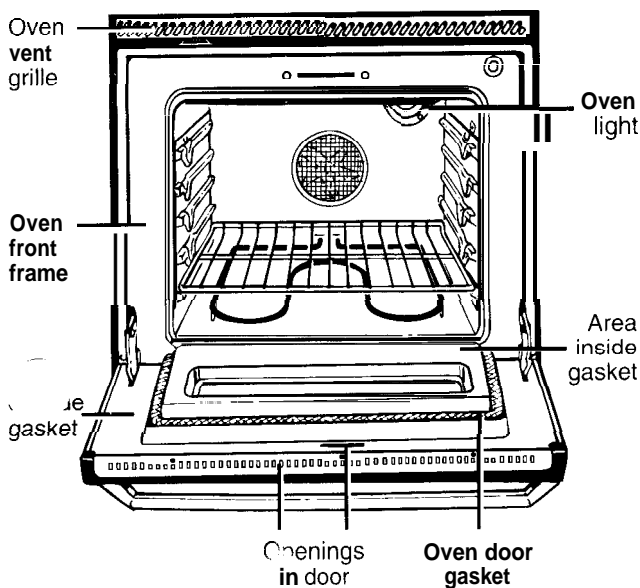

3. Clean spatters or soil on the oven front frame and the oven door outside the gasket with a dampened cloth. The oven front frame and the oven door outside the gasket do not get cleaned by the self-clean cycle. On these areas, use detergent and hot water or a soap-filled steel wool pad. Rinse well with a vinegar and water solution. This will help prevent a brown residue from forming when the oven is heated. Buff these areas with a dry cloth. Do not clean the gasket.

Clean the outside front of the oven door with soap and water. Also use soap and water to clean under the oven vent grille. **Do not use abrasives or oven cleaners.**

Make sure the oven light bulb cover is in place.

Do not rub or clean the door gasket— the fiberglass material of the gasket has an extremely low resistance to abrasion. An intact and well-fitting oven door gasket is essential for energy-efficient oven operation and good baking results. If you notice the gasket becoming worn, frayed or damaged in any way or if it has become displaced on the door, you should have it replaced.

Do not let water run down through openings in the top of the door. To help prevent water from getting in these slots when cleaning, open the door as far as it will go.

4. Close the oven door and make sure the oven light is off. If the oven light is not turned off, the life of the bulb will be shortened or it may burn out immediately. The door latches automatically after the clean cycle is set.

Do not use commercial oven cleaners or oven protectors in or near the self-cleaning oven. A combination of any of these products plus the high clean-cycle temperature may damage the porcelain finish of the oven.

(continued next page)



OPERATING THE SELF-CLEANING OVEN

(continued)

How to Set Oven for Cleaning

Quick Reminder:

1. Press the AUTO SELF CLEAN pad.
2. Press the INCREASE or DECREASE pad until the desired Clean Time appears.

If the oven is too hot and you start to set a clean cycle, the word "OFF" will appear in the display. Allow additional time for cooling before you try to set the cycle.

1. Follow the directions in the Before a Clean Cycle section.



2. After closing the door, press the AUTO SELF CLEAN pad.



3. Press the INCREASE or DECREASE pad until the desired Clean Time is displayed.
Clean Time is normally 3 hours. You can change the Clean Time to any time between 2 and 4 hours, depending on the amount of soil in your oven.

The self-clean cycle will automatically begin after "CLEAN" is displayed and the time for the clean cycle is set. The words "ON" and "LOCK" will appear in the display when the door automatically locks. It will not be possible to open the oven door until the temperature drops below the lock temperature and the LOCK light goes off.

4. When the LOCK light is off, open the door.

NOTE:

- The word "door" will be displayed, the word "LOCK" will flash and oven control will signal if you set the clean cycle and forget to close the oven door.
- A fan may automatically turn on and off to cool internal parts., This is normal and the fan may continue to run even after the oven is turned off.
- You can find out when the clean cycle will be finished by pressing the STOP TIME pad.



To Stop a Clean Cycle



1. Press the CLEAR/OFF pad.

2. When the LOCK light goes off and the oven has cooled below the locking temperature, open the door.



After Self-Cleaning

You may notice some white ash in the oven. Just wipe it up with a damp cloth after the oven cools.

If white spots remain, remove them with a soap-filled steel wool pad. Be sure to rinse thoroughly with a vinegar and water mixture. These deposits are usually a salt residue that cannot be removed by the clean cycle.

If the oven is not clean after one clean cycle, repeat the cycle.

If the shelves become hard to slide, wipe the shelf supports with cooking oil.

NOTE: No functions can be programmed before the door automatically unlocks.

How to Set Delay Start of Cleaning

Quick Reminder:

1. Press the AUTO SELF CLEAN pad.
2. Press the INCREASE or DECREASE pad until the desired Clean Time appears.
3. Press the STOP TIME pad.
4. Press the INCREASE or DECREASE pad until the desired Stop Time appears in the display.

Delay Start is setting the oven timer to start the clean cycle automatically at a later time than the present time of day.

NOTE: Before beginning, make sure the oven clock shows the correct time of day.

1. Follow the directions in the Before a Clean Cycle section.



2. After closing the door, press the AUTO SELF CLEAN pad.

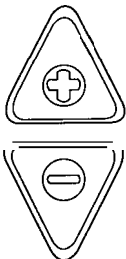

3. Press the INCREASE or DECREASE pad to enter the Clean Time.



4. Press the STOP TIME pad. "SET STOP TIME" and the earliest Stop Time you can set will appear in the display.

The earliest Stop Time will be the Clean Time selected plus the time of day. **For example:** If the Clean Time is 3 hours and the time of day is 6:00, the Stop Time that appears in the display will be 9:00.



5. Press the INCREASE pad to change the Stop Time to a later time of day if desired. **For example:** If you set the Stop Time at 11:00, the oven will start the clean cycle at 8:00 and end at 11:00. The door latches automatically.

The self-clean cycle will automatically begin after "CLEAN" is displayed and the time for the clean cycle is set. The words "ON" and "LOCK" will appear in the display when the door automatically locks. It will not be possible to open the oven door until the temperature drops below the lock temperature and the LOCK light goes off.

6. When the LOCK light is off, open the door.

NOTE:

- During a delayed self-clean operation you can find out when the oven is set to turn on by pressing and holding the AUTO SELF CLEAN pad for 3 seconds.
- A fan may automatically turn on and off to cool internal parts. This is normal and the fan may continue to run even after the oven is turned off.

(continued next page)



OPERATING THE SELF-CLEANING OVEN

(continued)

Questions and Answers

- Q. If my oven clock is not set to the correct time of day, can I still self-clean my oven?**
- A.** If the clock is not set to the correct time of day you will not be able to set a delay clean to end at a specific time.
- Q. Can I use commercial oven cleaners on any part of my self-cleaning oven?**
- A.** No cleaners or coatings should be used around any part of this oven. If you do use them and do not thoroughly rinse the oven with water, wiping it absolutely clean afterwards, the residue can scar the oven surface and damage metal parts the next time the oven is automatically cleaned.
- Q. What should I do if excessive smoking occurs during cleaning?**
- A.** This is caused by excessive soil. Turn the oven off. Open the windows to rid the room of smoke. Wait until the oven has cooled and the word "LOCK" is off in the display. Wipe up the excess soil and reset the clean cycle.
- Q. Is the "crackling" or "popping" sound I hear during cleaning normal?**
- A. Yes.** This is the sound of the metal heating and cooling during both the cooking and cleaning functions.
- Q. Should there be any odor during the cleaning?**
- A. Yes,** there will be an odor during the first few cleanings. Failure to wipe out excessive soil might also cause a strong odor when cleaning.
- Q. What causes the hair-like lines on the enameled surface of my oven?**
- A.** This is a normal condition, resulting from heating and cooling during cleaning. These lines do not affect how your oven performs.
- Q. Why do I have ash left in my oven after cleaning?**
- A.** Some types of soil will leave a deposit which is ash. It can be removed with a damp sponge or cloth.
- Q. My oven shelves do not slide easily. What is the matter?**
- A.** After many cleanings, the oven shelves will lose their luster and become hard to slide. To make the shelves slide more easily, wipe the shelf supports with cooking oil.
- Q. My oven shelves have become gray after the self-clean cycle. Is this normal?**
- A. Yes.** After the self-clean cycle, the shelves will lose some luster and discolor to a deep gray color.

CARE AND CLEANING

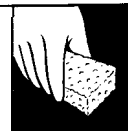

Proper care and cleaning are important so your oven will give you efficient and satisfactory service. Follow these directions carefully in caring for your oven to assure safe and proper maintenance.

BE SURE ELECTRICAL POWER IS OFF BEFORE CLEANING ANY PART OF THE OVEN.

Broiler Pan and Grid

After broiling, remove the broiler pan and grid from the oven. Remove the grid from the pan. Carefully pour out grease from the pan into a proper container. Wash and rinse the broiler pan and grid in hot water with a soap-filled or plastic scouring pad.

If food has burned on, sprinkle the grid with detergent while hot and cover with wet paper towels or a dishcloth. Soaking the pan will remove burned-on foods.

The broiler pan and grid may be cleaned with a commercial oven cleaner.

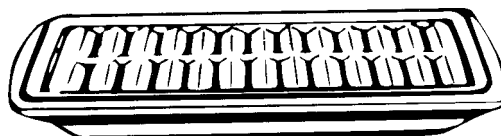

Do not store a soiled broiler pan and grid anywhere in the oven.

Do not clean the broiler pan and grid in the self-cleaning oven.

Both the broiler pan and grid can also be cleaned in the dishwasher.

Oven Shelves and Convection Roasting Rack

Clean the oven shelves (including the offset shelf) and convection roasting rack with an abrasive cleanser or steel wool. After cleaning, rinse the shelves and rack with clean water and dry with a clean cloth.

NOTE: The oven shelves and convection roasting rack may be cleaned in the self-cleaning oven.

However, the shelves will darken, lose their luster and become hard to slide. Wipe the shelf supports with cooking oil after self-cleaning to make the shelves slide more easily.

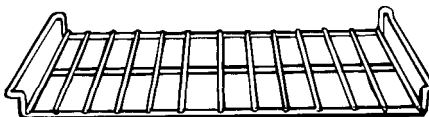

(continued next page)

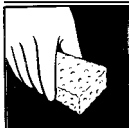

CARE AND CLEANING

(continued)

Lift-Off Oven Door

The oven door is **removable**, but it is heavy. You may need help removing and replacing the door. Do not lift the door by the handle. This can cause the glass to break or can cause damage to the door.

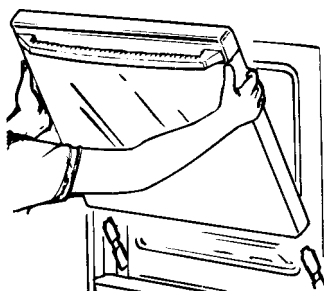

To **remove the door**, open it a few inches to the special stop position that will hold the door open. Grasp firmly on each side and lift the door straight up and off the hinges.

NOTE:

- Be careful not to place hands between the hinge and the oven door frame as the hinge could snap back and pinch fingers.
- While working in the oven area, cover the hinges with towels or empty paper towel rolls to prevent pinched fingers and chipping the porcelain enamel on the frame.

To **replace the door**, make sure the hinges are in the special stop position. Position the slots in the bottom of the door squarely over the hinges. Then lower the door slowly and evenly over both hinges at the same time. If hinges snap back against the oven frame, pull them back out.

TO CLEAN THE DOOR:

Inside of the door:

- Because the area inside the gasket is cleaned during the self clean cycle, you do not need to clean this by hand. Any soap left on the liner causes additional stains when the oven is heated.
- The area outside the gasket can be cleaned with a soap-filled scouring pad.
- **Do not rub or clean the door gasket**—the fiberglass material of the gasket has an extremely low resistance to abrasion. An intact and well-fitting oven door gasket is essential for energy-efficient oven operation and good baking results. If you notice the gasket becoming worn, frayed or damaged in any way or if it has become displaced on the door, you should have it replaced.

NOTE: The gasket is designed with a gap at the bottom to allow for proper air circulation.

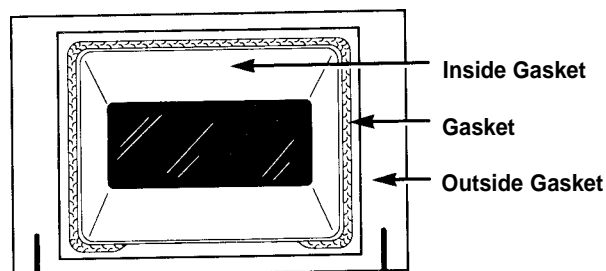

Outside of the door:

- Use soap and water to thoroughly clean the top, sides and front of the oven door. **DO NOT** let water run down through openings in the top of the door. Rinse well. You may also use a glass cleaner to clean the glass on the outside of the door.
- Spillage of marinades, fruit juices, tomato sauces and basting materials containing acids may cause discoloration and should be wiped up immediately. When surface is cool, clean and rinse.
- **Do not use oven cleaners, cleansing powders or harsh abrasives on the outside of the door.**



Probe

The temperature probe may be cleaned with soap and water or a soap-filled scouring pad. Cool the temperature probe before cleaning. Scour stubborn spots with a soap-filled scouring pad, rinse and dry.

Do not immerse the temperature probe in water. Do not store the temperature probe **in the oven**.

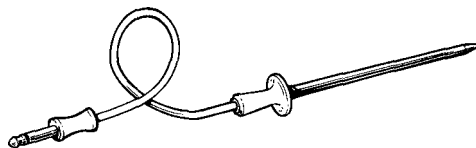

Oven Light Replacement

CAUTION: Before replacing your oven light bulb, disconnect the electrical power for your oven at the main fuse or circuit breaker panel.

Be sure to let the light cover and bulb cool completely before removing or replacing them. When in use, light bulbs can become warm enough to break if touched with a moist cloth or towel. When cleaning, avoid touching warm lights with cleaning cloths if the light cover is removed.

The oven light is covered with a removable glass cover which is held in place with a wire. Remove the oven door, if desired, to reach the cover easily.

remove:

Hold your hand under the cover so it doesn't fall when released. With fingers of the same hand, firmly push back the wire cover holder. Lift off the cover.

•DO NOT REMOVE ANY SCREWS.

•Replace bulb with 40-watt home appliance bulb.

To replace cover:

•Place it into the groove of the light receptacle. Pull the wire forward to the center of cover until it snaps in place. When in place, the wire holds the cover firmly. Be certain the wire is in the depression in the center of the cover.

•Connect the electrical power to the oven.

(continued next page)

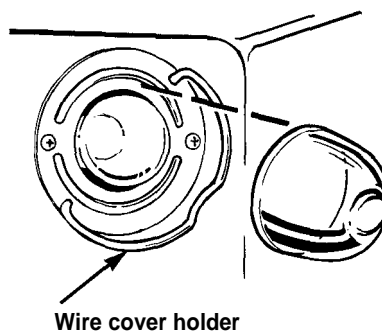

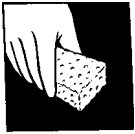

CARE AND CLEANING

(continued)

Control Panel

It's a good idea to wipe the control panel after each use. Clean with mild soap and water or vinegar and water, rinse with clean water and polish dry with a soft cloth.

Do not use abrasive cleansers, strong liquid cleaners, plastic scouring pads or oven cleaners on the control panel—they will damage the finish. A 50/50 solution of vinegar and hot water works well.

Glass Window

To clean the outside of the oven window, use a glass cleaner. Rinse and polish with a dry cloth.

Do not allow the water or cleaner to run down inside the openings in the glass or the openings in the top of the oven door while cleaning.

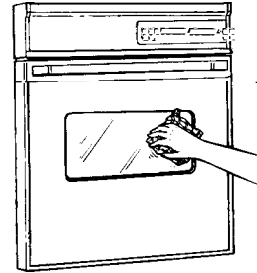

Metal Parts

Do not use steel wool, abrasives, ammonia or commercial oven cleaners. To safely clean surfaces: wash, rinse and then dry with a soft cloth.



Oven Heating Elements

Do not clean the bake element or the broil element. Any soil will burn off when the elements are heated.

The bake element can be lifted gently to clean the oven floor. If spillovers, residue or ash accumulate around the bake element gently wipe around the element with warm water.

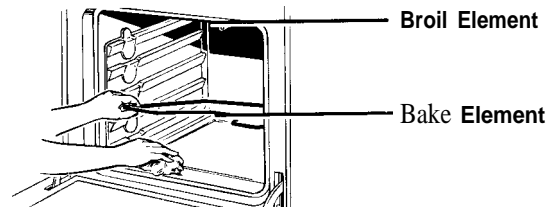

QUESTIONS? USE THIS PROBLEM SOLVER



| PROBLEM | POSSIBLE CAUSE |
|--|---|
| “F- AND A NUMBER” FLASH IN THE DISPLAY | <ul style="list-style-type: none"> • This is the function error code. Press the CLEAR/OFF pad. Allow oven to cool one hour. Place oven back into operation. If function error occurs again, disconnect power to the oven and call for service. |
| OVEN WILL NOT WORK | <ul style="list-style-type: none"> • The circuit breaker in your house has been tripped, or a fuse has been blown. • Oven controls not properly set. |
| OVEN LIGHT DOES NOT WORK | <ul style="list-style-type: none"> • Light bulb is loose or defective. Tighten or replace. • Button operating oven light is broken. Call for service. |
| FOOD DOES NOT BROIL PROPERLY | <ul style="list-style-type: none"> • The oven controls are not properly set. See the Broiling section. • The door not left open to the broil stop position as recommended. • Improper shelf position being used. • Food is being cooked on a hot pan. • Cookware is not suited for broiling. • Low voltage. See the Broiling section. • Aluminum foil used on the broiler pan grid has not been fitted properly and slit as recommended. |
| FOOD DOES NOT ROAST OR BAKE PROPERLY | <ul style="list-style-type: none"> • The oven controls are not properly set. See the Baking or Roasting section. • Shelf position is not correct.. • Incorrect cookware of improper size is being used. • The oven thermostat needs adjustment. See the Adjust the Oven Thermostat—<i>Do It Yourself</i> section. |
| OVEN WILL NOT SELF-CLEAN | <ul style="list-style-type: none"> • Temperature is too high to set self-clean operation. Allow the oven to cool, and reset the controls. • Probe is in oven. Remove the probe. |
| OVEN DOOR WILL NOT OPEN | <ul style="list-style-type: none"> • Oven must cool below locking temperature. |
| OVEN NOT CLEAN AFTER CLEAN CYCLE | <ul style="list-style-type: none"> • Oven controls not set properly. Review Operating the Self-Cleaning Oven section. • Heavily soiled ovens require 3½- to 4-hour Clean Time. • Heavy spillovers should be cleaned up before starting clean cycle. |
| “door” APPEARS IN THE DISPLAY | <ul style="list-style-type: none"> • Oven door not closed after self-clean cycle selected. • Door is still locked and you are trying to enter an oven cooking operation. |
| “OFF” APPEARS IN THE DISPLAY | <ul style="list-style-type: none"> • Oven is too hot for Self-Clean. • Bake or Broil attempted too soon after Self-Clean. • Child Lockout feature turned on. |

(continued next page)



PROBLEM SOLVER

(continued)

| PROBLEM | POSSIBLE CAUSE |
|---|--|
| OVEN CONTROL SIGNALS AFTER ENTERING SELF-CLEAN OR STOP TIME | <ul style="list-style-type: none">• This is reminding you to enter a bake temperature.• This is reminding you to close the oven door so the self-clean cycle can start. |
| OVEN TEMPERATURE TOO HOT OR TOO COLD | <ul style="list-style-type: none">• The oven thermostat needs adjustment. See the <i>Adjust the Oven Thermostat—Do it Yourself</i> section. |
| “BURNING” OR “OILY” ODOR EMITTING FROM OVEN WHEN TURNED ON | <ul style="list-style-type: none">• This is normal in a new oven and will disappear in time. To speed the process, set a self-clean cycle for a minimum of 3 hours. See the <i>Operating the Self-Cleaning Oven</i> section. |
| STRONG ODOR | <ul style="list-style-type: none">• An odor from the insulation around the inside of the oven is normal for the first few times the oven is used. This is temporary. |
| FAN NOISE | <ul style="list-style-type: none">• A fan may automatically turn on and off to cool internal parts. This is normal, and the fan may continue to run after the oven is turned off. |

If you need more help...

call, toll free:

GE Answer Center®

800.626.2000

consumer information service

We'll Be There

With the purchase of your new GE appliance, receive the assurance that if you ever need information or assistance from GE, we'll be there. All you have to do is call—toll-free!

GE Answer Center® **800.626.2000**

Whatever your question about any GE major appliance, GE Answer Center® information service is available to help. Your call—and your question—will be answered promptly and courteously. And you can call any time. GE Answer Center® service is open 24 hours a day, 7 days a week.

In-Home Repair Service **800-GE-CARES (800-432-2737)**

A GE consumer service professional will provide expert repair service, scheduled at a time that's convenient for you. Many GE Consumer Service company-operated locations offer you service today or tomorrow, or at your convenience (7:00 a.m. to 7:00 p.m. weekdays, 9:00 a.m. to 2:00 p.m. Saturdays). Our factory-trained technicians know your appliance inside and out—so most repairs can be handled in just one visit.

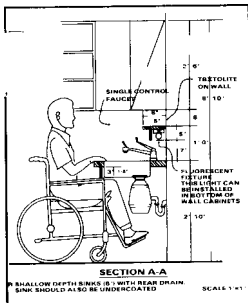

For Customers With Special Needs... **800.626.2000**

Upon request, GE will provide Braille controls for a variety of GE appliances, and a brochure to assist in planning a barrier-free kitchen for persons with limited mobility. To obtain these items, free of charge, call 800.626.2000.

Consumers with impaired hearing or speech who have access to a TDD or a conventional teletypewriter may call 800-TDD-GEAC (800-833-4322) to request information or service.

Service Contracts **800-626-2224**

You can have the secure feeling that GE Consumer Service will still be there after your warranty expires. Purchase a GE contract while your warranty is still in effect and you'll receive a substantial discount. With a multiple-year contract, you're assured of future service at today's prices.

Parts and Accessories **800-626-2002**

Individuals qualified to service their own appliances can have needed parts or accessories sent directly to their home. The GE parts system provides access to over 47,000 parts...and all GE Genuine Renewal Parts are fully warranted. VISA, MasterCard and Discover cards are accepted.

User maintenance instructions contained in this guide cover procedures intended to be performed by any user. Other servicing generally should be referred to qualified service personnel. Caution must be exercised, since improper servicing may cause unsafe operation.

YOUR GE ELECTRIC OVEN WARRANTY

Staple sales slip or cancelled check here. Proof of original purchase date is needed to obtain service under warranty.

WHAT IS COVERED

FULL ONE-YEAR WARRANTY

For one year from date of original purchase, we will provide, free of charge, parts and service labor in your home to repair or replace **any part of the oven** that fails because of a manufacturing defect.

This warranty is extended to the original purchaser and any succeeding owner for products purchased for ordinary home use in the 48 mainland states, Hawaii and Washington, D.C. In Alaska the warranty is the same except that it is LIMITED because you must pay to ship the product to the service shop or for the service technician's travel costs to your home. All warranty service will be provided by our Factory Service Centers or by our authorized Customer Care® servicers during normal working hours. Should your appliance need service, during warranty period or beyond, call 800-GE-CARES (800-432-2737).

WHAT IS NOT COVERED

- Service trips to your home to teach you how to use the product.

Read your Use and Care material.

If you then have any questions about operating the product, please contact your dealer or our Consumer Affairs office at the address below, or call, toll free:

GE Answer Center®
800.626.2000
consumer information service

- Improper installation.

If you have an installation problem, contact your dealer or installer. You are responsible for providing adequate electrical, gas, exhausting and other connecting facilities as described in the Installation instructions provided with the product.

- Replacement of house fuses or resetting of circuit breakers.

- Failure of the product if it is used for other than its intended purpose or used commercially.

- Damage to product caused by accident, fire, floods or acts of God.

WARRANTOR IS NOT RESPONSIBLE FOR CONSEQUENTIAL DAMAGES.

Some states do not allow the exclusion or limitation of incidental or consequential damages, so the above limitation or exclusion may not apply to you. This warranty gives you specific legal rights, and you may also have other rights which vary from state to state. To know what your legal rights are in your state, consult your local or state consumer affairs office or your state's Attorney General.

Warrantor: General Electric Company

**If further help is needed concerning this warranty, write:
Manager—Consumer Affairs, GE Appliances, Louisville, KY 40225**



Recycled Paper

Part No. 164D2966P124

Pub No. 49-8603

2-95 CG

JKF
JKP1/
JKP18

Printed in LaFayette, GA

Free Manuals Download Website

<http://myh66.com>

<http://usermanuals.us>

<http://www.somanuals.com>

<http://www.4manuals.cc>

<http://www.manual-lib.com>

<http://www.404manual.com>

<http://www.luxmanual.com>

<http://aubethermostatmanual.com>

Golf course search by state

<http://golfingnear.com>

Email search by domain

<http://emailbydomain.com>

Auto manuals search

<http://auto.somanuals.com>

TV manuals search

<http://tv.somanuals.com>