



# Microwave Cooking Center

*Safety Instructions* ..... 2-9

*Operating Instructions*

Microwave Control Panel .....10, 11  
Microwave Oven Controls .....10-21  
Lower Oven Control Panel ....22, 23  
Lower Oven Controls .....22-32  
Lower Oven Thermostat .....30  
Self-Cleaning Lower Oven .... 31, 32  
Sensor Controls .....16, 17

*Care and Cleaning*

Broiler Pan and Grid .....36  
Door .....34  
Light Bulb .....35  
Microwave Oven ..... 33  
Shelves .....36

*Troubleshooting Tips* ..... 37-39

*Consumer Support*

Consumer Support ..... Back Cover  
Product Registration ..... 41-42  
Warranty .....43

**Owner's Manual**

*JKP86-27" Double Wall Oven*  
*JTP86-30" Double Wall Oven*

*The microwave oven in this cooking center is 1000 watts.*

**Write the model and serial numbers here:**

**Model #** \_\_\_\_\_

**Serial #** \_\_\_\_\_

You can find them on a label inside the upper oven on the left side.



## IMPORTANT SAFETY INFORMATION. READ ALL INSTRUCTIONS BEFORE USING.

### **⚠ WARNING!**

For your safety, the information in this manual must be followed to minimize the risk of fire or explosion, electric shock, or to prevent property damage, personal injury, or loss of life.



### PRECAUTIONS TO AVOID POSSIBLE EXPOSURE TO EXCESSIVE MICROWAVE ENERGY

- Do not attempt to operate this oven with the door open since open-door operation can result in harmful exposure to microwave energy. **It is important not to defeat or tamper with the safety interlocks.**
- Do not place any object between the oven front face and the door or allow soil or cleaner residue to accumulate on sealing surfaces.
- The oven should not be adjusted or repaired by anyone except properly qualified service personnel.
- Do not operate the oven if it is damaged. It is particularly important that the oven door close properly and that there is no damage to the:
  - 1 door (bent),
  - 2 hinges and latches (broken or loosened),
  - 3 door seals and sealing surfaces.



### IMPORTANT SAFETY NOTICE

The California Safe Drinking Water and Toxic Enforcement Act requires the Governor of California to publish a list of substances known to the state to cause cancer, birth defects or other reproductive harm, and requires businesses to warn customers of potential exposure to such substances.

The fiberglass insulation in self-clean ovens gives off a very small amount of carbon monoxide during the cleaning cycle. Exposure can be minimized by venting with an open window or using a ventilation fan or hood.



## SAFETY PRECAUTIONS

When using electrical appliances, basic safety precautions should be followed, including the following:

### **WARNING**—*Grounding Instructions:*

This appliance must be connected to a grounded, metallic, permanent wiring system, or an equipment grounding conductor should be run with the circuit conductors and connected to the equipment grounding terminal or lead on the appliance.

### **WARNING**—*To reduce the risk of burns, electric shock, fire, injury to persons or exposure to excessive microwave energy:*

- Use this appliance only for its intended use as described in this manual. Do not use corrosive chemicals or vapors in this appliance. This cooking center is specifically designed to heat or cook food, and is not intended for laboratory or industrial use.
- Be sure your appliance is properly installed and grounded by a qualified technician in accordance with the provided Installation Instructions.
- Have the installer show you the location of the circuit breaker or fuse. Mark it for easy reference.
- Be sure the cooking center is securely installed in a cabinet that is firmly attached to the house structure. Weight on the oven door could cause the oven to tip and result in injury. Never allow anyone to climb, sit or hang on the oven door.
- This appliance should be serviced only by qualified service personnel. Contact nearest authorized service facility for examination, repair or adjustment. Do not repair or replace any part of this appliance unless specifically recommended in this manual. All other servicing should be referred to a qualified technician.
- Do not store this appliance outdoors. Do not use this product near water—for example, in a wet basement, or near a swimming pool.
- Before performing any service, disconnect the cooking center power supply at the household distribution panel by removing the fuse or switching off the circuit breaker.
- Do not operate this appliance if it has a damaged cord or plug, if it is not working properly, or if it has been damaged or dropped.
- Do not leave children alone—children should not be left alone or unattended in an area where appliance is in use. They should never be allowed to sit or stand on any part of the appliance.
- Don't allow anyone to climb, stand or hang on the door. They could damage the cooking center and cause severe personal injury.

## IMPORTANT SAFETY INFORMATION. READ ALL INSTRUCTIONS BEFORE USING.



### **⚠ WARNING!** SAFETY PRECAUTIONS

*Do not use water on grease fires. Never pick up a flaming pan. Smother flaming pan by covering pan completely with well-fitting lid, cookie sheet or flat tray. Flaming grease outside a pan can be put out by covering with baking soda or, if available, a multi-purpose dry chemical or foam-type fire extinguisher.*

- **CAUTION:** Items of interest to children should not be stored in cabinets above an oven; children climbing on the oven to reach items could be seriously injured.
  - Teach children not to play with the controls or any other part of the cooking center.
  - Large scratches or impacts to glass door can lead to broken or shattered glass.
  - Wear proper clothing. Loose-fitting or hanging garments should never be worn while using the appliance. Flammable material could be ignited if brought in contact with hot heating elements and may cause severe burns.
  - Use only dry pot holders—moist or damp pot holders on hot surfaces may result in burns from steam. Do not let pot holders touch hot heating elements. Do not use a towel or other bulky cloth. Such cloths can catch fire on a hot element.
  - Always keep dish towels, dishcloths, pot holders and other linens a safe distance from your oven.
  - Always keep wooden spoons and plastic utensils and canned food a safe distance away from your oven.
  - Always keep combustible wall coverings, curtains or drapes a safe distance from your oven.
  - Do not store flammable material in an oven or near the cooking center.
  - Do not cover or block any openings on the appliance.
  - For your safety, never use your appliance for warming or heating the room.
  - Do not leave paper products, cooking utensils or food in the oven when not in use.
  - Do not store or use combustible materials, gasoline or other flammable vapors and liquids in the vicinity of this or any other appliance.
  - Do not let cooking grease or other flammable materials accumulate in or near the cooking center.
  - Do not touch heating elements or interior surface of the oven. These surfaces may be hot enough to burn even though they are dark in color. During and after use, do not touch, or let clothing or other flammable materials contact any interior area of the oven; allow sufficient time for cooling first.
- Potentially hot surfaces include oven vent openings, surfaces near the openings, and crevices around the oven door.
- REMEMBER:** The inside surface of the oven may be hot when the door is opened.



### COOK MEAT AND POULTRY THOROUGHLY...

*Cook meat and poultry thoroughly—meat to at least an INTERNAL temperature of 160°F and poultry to at least an INTERNAL temperature of 180°F. Cooking to these temperatures usually protects against foodborne illness.*



## MICROWAVE OVEN

Read and follow the specific "Precautions to Avoid Possible Exposure to Excessive Microwave Energy" section in this manual.

### To reduce the risk of fire in the oven cavity:

- Do not overcook food. Carefully attend appliance if paper, plastic or other combustible materials are placed inside the oven to facilitate cooking.
  - Remove wire twist-ties from paper or plastic containers before placing bags in oven.
  - Do not use your microwave oven to dry newspapers.
  - Do not pop popcorn in your microwave oven unless in a special microwave popcorn accessory or unless you use popcorn labeled for use in microwave ovens.
  - Do not overcook potatoes. They could dehydrate and catch fire, causing damage to your oven.
  - Do not operate the oven while empty to avoid damage to the oven and the danger of fire. If by accident the oven should run empty a minute or two, no harm is done. However, try to avoid operating the oven empty at any time—it saves energy and prolongs the life of the oven.
  - Do not use the oven for storage purposes. Do not leave paper products, cooking utensils or food in the oven when not in use.
  - If materials inside the oven should ignite, keep oven door closed, turn oven off, and shut off power at the fuse or circuit breaker panel. If the door is opened, the fire may spread.
  - This microwave oven is not approved or tested for marine use.
- Some products such as whole eggs and sealed containers—for example, closed jars—will explode and should not be heated in this microwave oven. Such use of the microwave oven could result in injury.
  - Do not operate the microwave oven without the turntable and support in place.
  - Avoid heating baby food in glass jars, even with the lid off. Make sure all infant food is thoroughly cooked. Stir food to distribute the heat evenly. Be careful to prevent scalding when warming formula or breast milk. The container may feel cooler than the milk really is. Always test the milk before feeding the baby.
  - Do not boil eggs in a microwave oven. Pressure will build up inside the egg yolk and will cause it to burst, possibly resulting in injury.
  - Foods with unbroken outer "skin" such as potatoes, sausages, tomatoes, apples, egg yolks, chicken livers and other giblets should be pierced to allow steam to escape during cooking.
  - Don't defrost frozen beverages in narrow-necked bottles (especially carbonated beverages). Even if the container is opened, pressure can build up. This can cause the container to burst, possibly resulting in injury.
  - Hot foods and steam can cause burns. Be careful when opening any containers of hot food, including popcorn bags, cooking pouches and boxes. To prevent possible injury, direct steam away from hands and face.
  - As with any appliance, close supervision is necessary when used by children.

## IMPORTANT SAFETY INFORMATION. READ ALL INSTRUCTIONS BEFORE USING.



### **⚠ WARNING!**

#### MICROWAVE-SAFE COOKWARE

*Make sure all cookware used in your microwave oven is suitable for microwaving. Most glass casseroles, cooking dishes, measuring cups, custard cups, pottery or china dinnerware which does not have metallic trim or glaze with a metallic sheen can be used. Some cookware is labeled "suitable for microwaving."*

- If you are not sure if a dish is microwave-safe, use this test: Place in the oven both the dish you are testing and a glass measuring cup filled with 1 cup of water—set the measuring cup either in or next to the dish. Microwave 35–45 seconds at high. If the dish heats, it should not be used for microwaving.  
If the dish remains cool and only the water in the cup heats, then the dish is microwave-safe.
- If you use a meat thermometer while cooking, make sure it is safe for use in microwave ovens.
- Do not use recycled paper products. Recycled paper towels, napkins and waxed paper can contain metal flecks which may cause arcing or ignite. Paper products containing nylon or nylon filaments should be avoided, since they may also ignite.
- Some Styrofoam trays (like those that meat is packaged on) have a thin strip of metal embedded in the bottom. When microwaved, the metal can burn the floor of the oven or ignite a paper towel.
- Not all plastic wrap is suitable for use in microwave ovens. Check the package for proper use.
- Paper towels, waxed paper and plastic wrap can be used to cover dishes in order to retain moisture and prevent spattering. Be sure to vent plastic wrap so steam can escape.
- Oversized food or oversized metal cookware should not be used in a microwave oven. Electrical shock or fire could occur.
- While paper plates may be used for timed cooking and defrosting, do not use them with Auto Sensor cooking. Use microwave-safe plates or bowls for reheating. Cover with plastic wrap.
- Cookware may become hot because of heat transferred from the heated food. Pot holders may be needed to handle the cookware.
- “Boilable” cooking pouches and tightly closed plastic bags should be slit, pierced or vented as directed by package. If they are not, plastic could burst during or immediately after cooking, possibly resulting in injury. Also, plastic storage containers should be at least partially uncovered because they form a tight seal. When cooking with containers tightly covered with plastic wrap, remove covering carefully and direct steam away from hands and face.
- Use foil only as directed in this manual. TV dinners may be microwaved in foil trays less than 3/4" high; remove the top foil cover and return the tray to the box. When using foil in the microwave oven, keep the foil at least 1 inch away from the sides of the oven.

- Plastic cookware – Plastic cookware designed for microwave cooking is very useful, but should be used carefully. Even microwave-safe plastic may not be as tolerant of overcooking conditions as are glass or ceramic materials and may soften or char if subjected to short periods of overcooking. In longer exposures to overcooking, the food and cookware could ignite.

**Follow these guidelines:**

- 1 Use microwave-safe plastics only and use them in strict compliance with the cookware manufacturer's recommendations.
- 2 Do not microwave empty containers.
- 3 Do not permit children to use plastic cookware without complete supervision.



## ARCING

*If you see arcing, press the CLEAR/OFF pad and correct the problem.*

**Arcing is the microwave term for sparks in the oven. Arcing is caused by:**

- Metal or foil touching the side of the oven.
- Foil not molded to food (upturned edges act like antennas).
- Metal, such as twist-ties, poultry pins or gold-rimmed dishes, in the microwave.
- Recycled paper towels containing small metal pieces being used in the microwave.



## SUPERHEATED WATER

*Microwaved water and other liquids do not always bubble when they reach the boiling point. They can actually get superheated and not bubble at all.*

Superheated liquid will bubble up out of the cup when it is moved or when something like a spoon or tea bag is put into it.

To prevent this from happening and causing injury, do not heat any liquid for more than 2 minutes per cup.

After heating, let the cup stand in the microwave for 30 seconds before moving it or putting anything into it.

### **Spontaneous boiling**

*Under certain special circumstances, liquids may start to boil during or shortly after removal from the microwave oven.*

To prevent burns from splashing liquid, we recommend the following before removing the container from the oven:

- Allow the container to stand in the oven for 30 to 40 seconds after the oven has shut off.
- Do not boil liquids in narrow-necked containers such as soft drink bottles, wine flasks and especially narrow-necked coffee cups. Even if the container is opened, excessive steam can build up and cause it to burst or overflow.

## IMPORTANT SAFETY INFORMATION. READ ALL INSTRUCTIONS BEFORE USING.



### ALL THESE THINGS ARE NORMAL WITH YOUR MICROWAVE

- Steam or vapor escaping from around the door.
- Light reflection around the door or the outer case.
- Dimming of the oven light and change in the blower sound may occur while operating at power levels other than high.
- The microwave fan may operate with both ovens off. It is cooling the control and will turn itself off.
- Some TV-radio interference might be noticed while using your microwave oven. It's similar to the interference caused by other small appliances and does not indicate a problem with your oven.
- A dull thumping sound while the oven is operating.



### MICROWAVE TERMS AND DEFINITIONS

#### **Arcing**

*Arcing is the microwave term for sparks in the oven. Arcing is caused by:*

- metal or foil touching the side of the oven.
- foil that is not molded to food (upturned edges act like antennas).
- metal such as twist-ties, poultry pins, gold-rimmed dishes.
- recycled paper towels containing small metal pieces.

#### **Covering**

*Covers hold in moisture, allow for more even heating and reduce cooking time. Venting plastic wrap or covering with wax paper allows excess steam to escape.*

#### **Shielding**

*In a regular oven, you shield chicken breasts or baked foods to prevent overbrowning. When microwaving, you use small strips of foil to shield thin parts, such as the tips of wings and legs on poultry, which would cook before larger parts.*

#### **Standing Time**

*When you cook with regular ovens, foods such as roasts or cakes are allowed to stand to finish cooking or to set. Standing time is especially important in microwave cooking. Note that a microwaved cake is not placed on a cooling rack.*

#### **Venting**

*After covering a dish with plastic wrap, you vent the plastic wrap by turning back one corner so excess steam can escape.*





## **⚠ WARNING!** SELF-CLEANING LOWER OVEN

*Do not use aluminum foil to line oven bottoms, except as suggested in this manual. Improper installation of aluminum foil may result in a risk of electric shock or fire.*

- Stand away from the oven when opening the oven door. Hot air or steam which escapes can cause burns to hands, face and/or eyes.
- Do not heat unopened food containers. Pressure could build up and the container could burst, causing an injury.
- Keep the oven vent unobstructed.
- Keep the oven free from grease buildup.
- Keep the cooking center clean and free of accumulations of grease or spillovers, which may ignite.
- Never leave the oven door open when you are not watching the cooking center.
- Place the oven shelf in the desired position while the oven is cool. If shelves must be handled when hot, do not let pot holder contact the heating elements.
- When using cooking or roasting bags in the oven, follow the manufacturer's directions.
- Pulling out the shelf to the stop-lock is a convenience in lifting heavy foods. It is also a precaution against burns from touching hot surfaces of the door or oven walls.
- Do not use the oven for a storage area. Items stored in an oven can ignite.
- Do not leave paper products, cooking utensils or food in the oven when not in use.
- After broiling, always take the broiler pan out of the oven and clean it. Leftover grease in the broiler pan can catch fire next time you use the oven.
- Do not use the oven to dry newspapers. If overheated, they can catch on fire.
- Never leave jars or cans of fat drippings in or near your oven.
- Clean only parts listed in this Owner's Manual.
- Do not clean the door gasket. The door gasket is essential for a good seal. Care should be taken not to rub, damage or move the gasket.
- Do not use oven cleaners. No commercial oven cleaner or oven liner protective coating of any kind should be used in or around any part of the oven. Residue from oven cleaners will damage the inside of the oven when the self-clean cycle is used.
- Before self-cleaning the oven, remove the probe, broiler pan, grid and other cookware.
- Be sure to wipe up excess spillage before starting a self-cleaning cycle.
- If the self-cleaning mode malfunctions, turn the oven off and disconnect the power supply. Have it serviced by a qualified technician.
- Listen for a fan—a fan noise should be heard sometime during the cleaning cycle. If not, call for service before self-cleaning again.



**READ AND FOLLOW THIS SAFETY INFORMATION CAREFULLY.**  
**SAVE THESE INSTRUCTIONS**

## Using the microwave oven controls.

Throughout this manual, features and appearance may vary from your model. Your model may have one of the following controls.

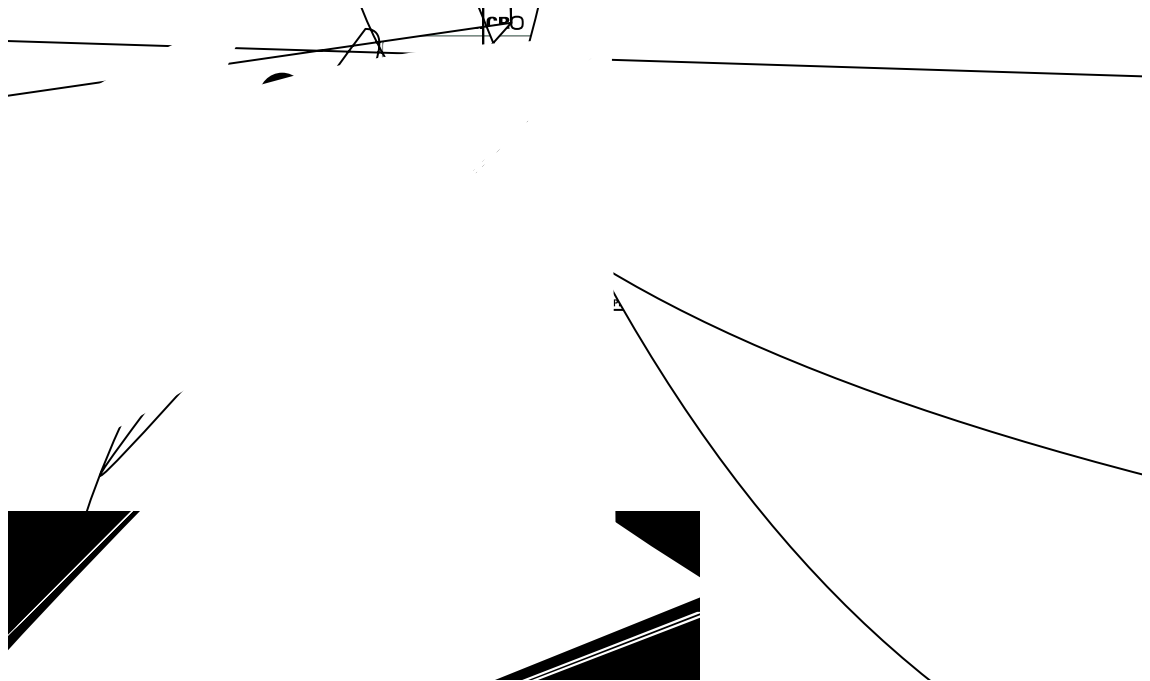
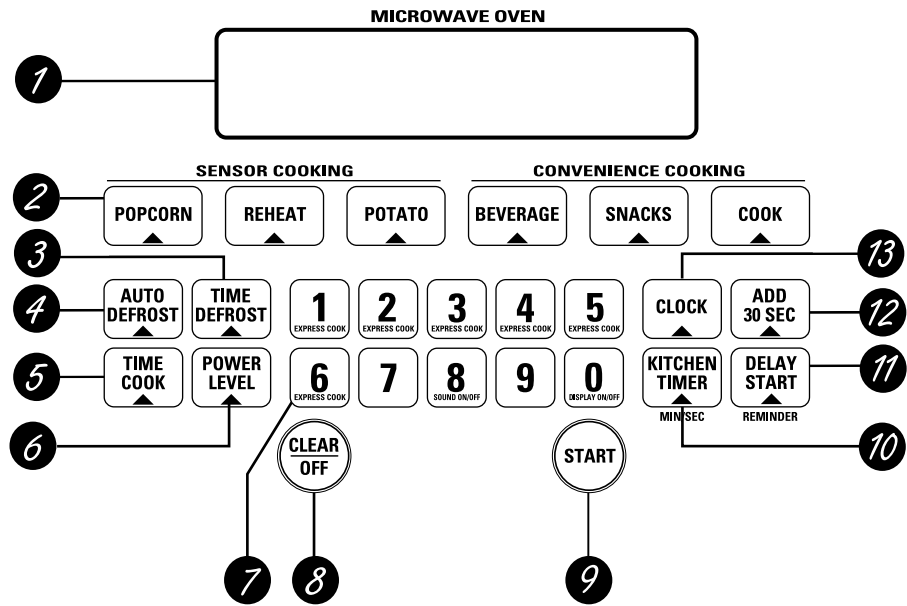



## Microwave Oven Control Features and Settings

- 1** **Display**  
Displays the time during cooking functions, the power level being used, the Auto Codes, the Auto Defrost food weights, the cooking mode and instructions.  
**NOTE:** The time on the microwave display is shown in minutes and seconds (1:30 is one minute, 30 seconds). On the lower oven, time is shown in hours and minutes (1:30 is one hour, 30 minutes).
- 2** **AUTO SENSOR AND CONVENIENCE CONTROLS**  
The top row of pads lists specific items you may choose to heat or cook.  
**POPCORN**  
Use to pop popcorn.  
**REHEAT**  
Use when foods need a quick warm up.  
**POTATO**  
Use when cooking whole potatoes.  
**BEVERAGE**  
Use to heat a cup of coffee or other beverage.  
**SNACKS**  
Use to warm a variety of snack foods.  
**COOK**  
Use to automatically set the cooking times and power levels for a variety of foods.
- 3** **TIME DEFROST**  
Use Time Defrost for most other foods.
- 4** **AUTO DEFROST**  
Use Auto Defrost for meat, poultry and fish.
- 5** **TIME COOK**  
Allows you to microwave for any time up to 99 minutes and 59 seconds.
- 6** **POWER LEVEL**  
Press to choose the power level you want to set. Watch the display while pressing this pad to select the power level you want to set. You will also see a defrost level. This setting will allow you to choose your own defrost power level by using the number pads.
- 7** **Number Pads**  
After pressing a function pad, press the number pads to set the exact amount of time you want to cook. For example, if you press the **1**, **2** and **5** pads, you have set 1 minute and 25 seconds.
- 8** **CLEAR/OFF**  
Pressing the **CLEAR/OFF** pad cancels all microwave cooking functions. It does not cancel the Kitchen Timer.
- 9** **START**  
After all selections are made, press this pad to start the oven. The **START** pad must be pressed to turn on any function.
- 10** **KITCHEN TIMER MIN/SEC**  
Press to set the timer up to 99 minutes and 59 seconds. Press the number pads to set the time. Press the **KITCHEN TIMER MIN/SEC** pad again to start. Press the **KITCHEN TIMER MIN/SEC** pad twice to clear the display.  
*Does not turn on microwave energy.*
- 11** **DELAY START**  
Allows you to set the microwave to delay cooking up to 12 hours.
- 12** **ADD 30 SEC**  
Each time you press this pad the set time is increased 30 seconds.
- 13** **CLOCK**  
Press this pad before setting the clock.



# Using the timed microwave features.

ge.com

Safety Instructions

Operating Instructions

Care and Cleaning

Troubleshooting Tips

Consumer Support

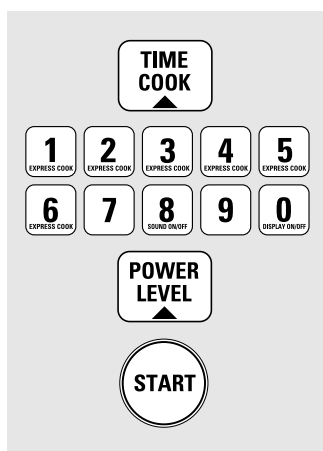

## Time Cook I

Allows you to microwave for any time up to 99 minutes and 59 seconds.

**Power level 10 (High)** is automatically set, but you may change it for more flexibility.

- 1 Press the **TIME COOK** pad.
- 2 Enter cooking time. For example, press **1**, **5**, **0** and **0** for 15 minutes.
- 3 Change power level if you don't want full power. (Press the **POWER LEVEL** pad. Select a desired power level 1-10.)

- 4 Press the **START** pad.

You may open the door during Time Cook to check the food. Close the door and press the **START** pad to resume cooking.

## Time Cook II

Lets you change power levels automatically during cooking. Here's how to do it:

- 1 Press the **TIME COOK** pad.
- 2 Enter cooking time.
- 3 Change power level if you don't want full power. (Press the **POWER LEVEL** pad. Select a desired power level 1-10.)
- 4 Press the **TIME COOK** pad again.

- 5 Enter the second cook time.
- 6 Change the power level if you don't want full power. (Press the **POWER LEVEL** pad. Select a desired power level 1-10.)
- 7 Press the **START** pad.

At the end of Time Cook I, Time Cook II counts down.

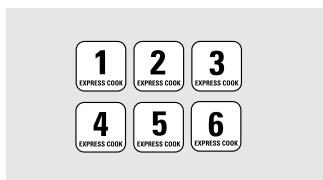

## Express Cook

This is a quick way to set cooking time for 1-6 minutes.

Press one of the **EXPRESS COOK** pads (from **1** to **6**) for 1 to 6 minutes of cooking at **power level 10**. For example, press the **2** pad for 2 minutes of cooking time.

The power level can be changed as time is counting down. Press the **POWER LEVEL** pad and enter 1-10.



## Add 30 Seconds

You can use this feature two ways:

- It will add 30 seconds to the time counting down each time the pad is pressed.
- It can be used as a quick way to set 30 seconds of cooking time. No need to press the **START** pad; the oven will start immediately.

## Using the timed microwave features.

Cooking Guide For Time Cook. Use power level High (10) unless otherwise noted.

Vegetable	Amount	Time	Comments
<b>Asparagus</b> (fresh spears)	1 lb.	7 to 10 min. Med-High (7)	In 1½-qt. casserole, place 1/4 cup water.
(frozen spears)	10-oz. package	5 to 8 min.	In 1-qt. casserole.
<b>Beans</b> (fresh green)	1 lb. cut in half	12 to 17 min.	In 1½-qt. casserole, place 1/2 cup water.
(frozen green)	10-oz. package	6 to 9 min.	In 1-qt. casserole, place 2 tablespoons water.
(frozen lima)	10-oz. package	6 to 9 min.	In 1-qt. casserole, place 1/4 cup water.
<b>Beets</b> (fresh, whole)	1 bunch	18 to 25 min.	In 2-qt. casserole, place 1/2 cup water.
<b>Broccoli</b> (fresh cut)	1 bunch (1¼ to 1½ lbs.)	7 to 10 min.	In 2-qt. casserole, place 1/2 cup water.
(fresh spears)	1 bunch (1¼ to 1½ lbs.)	9 to 13 min.	In 2-qt. casserole, place 1/4 cup water.
(frozen, chopped)	10-oz. package	5 to 8 min.	In 1-qt. casserole.
(frozen spears)	10-oz. package	5 to 8 min.	In 1-qt. casserole, place 3 tablespoons water.
<b>Cabbage</b> (fresh)	1 medium head (about 2 lbs.)	8 to 11 min.	In 1½- or 2-qt. casserole, place 1/4 cup water.
(wedges)		7 to 10 min.	In 2- or 3-qt. casserole, place 1/4 cup water.
<b>Carrots</b> (fresh, sliced)	1 lb.	6 to 9 min.	In 1½-qt. casserole, place 1/4 cup water.
(frozen)	10-oz. package	5 to 8 min.	In 1-qt. casserole, place 2 tablespoons water.
<b>Cauliflower</b> (flowerets)	1 medium head	9 to 14 min.	In 2-qt. casserole, place 1/2 cup water.
(fresh, whole)	1 medium head	9 to 17 min.	In 2-qt. casserole, place 1/2 cup water.
(frozen)	10-oz. package	5½ to 8 min.	In 1-qt. casserole, place 2 tablespoons water.
<b>Corn</b> (frozen kernel)	10-oz. package	4 to 8 min.	In 1-qt. casserole, place 2 tablespoons water.
<b>Corn on the cob</b> (fresh)	1 to 3 ears per ear	3 to 5 min.	In 2-qt. glass baking dish, place corn. If corn is in husk, use no water; if corn has been husked, add 1/4 cup water. Rearrange after half of time.
(frozen)	1 ear 2 to 3 ears	5 to 7 min. 2 to 4 min. per ear	Place in a round glass baking dish. Cover with vented plastic wrap. Rearrange after half of time.
<b>Mixed vegetables</b> (frozen)	10-oz. package	4 to 8 min.	In 1-qt. casserole, place 3 tablespoons water.
<b>Peas</b> (fresh, shelled)	2 lbs. unshelled	9 to 12 min.	In 1-qt. casserole, place 1/4 cup water.
(frozen)	10-oz. package	4 to 8 min.	In 1-qt. casserole, place 2 tablespoons water.
<b>Potatoes</b> (fresh, cubed, white)	4 potatoes (6 to 8 oz. each)	11 to 14 min.	Peel and cut into 1-inch cubes. Place in 2-qt. casserole with 1/2 cup water. Stir after half of time.
(fresh, whole, sweet or white)	1 (6 to 8 oz.)	2 to 5 min.	Pierce with cooking fork. Place in the oven, 1 inch apart, in circular arrangement. Let stand 5 minutes.
<b>Spinach</b> (fresh)	10 to 16 oz.	5 to 8 min.	In 2-qt. casserole, place washed spinach.
(frozen, chopped and leaf)	10-oz. package	5 to 8 min.	In 1-qt. casserole, place 3 tablespoons water.
<b>Squash</b> (fresh, summer and yellow)	1 lb. sliced	4 to 7 min.	In 1½-qt. casserole, place 1/4 cup water.
(winter, acorn or butternut)	1 squash (about 1 lb. each)	7 to 11 min.	Cut in half and remove fibrous membranes. In 2-qt. glass baking dish, place squash cut-side-down. Turn cut-side-up after 4 minutes.

A dull thumping noise may be heard during defrosting. This is normal when oven is not operating at High power.

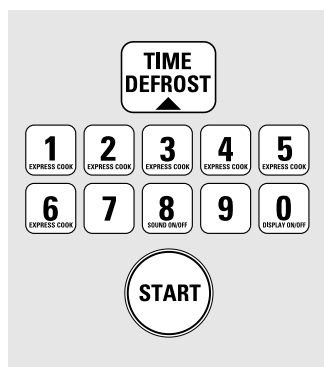

At one half of selected defrosting time, the oven signals **TURN**. At this time, turn food over and break apart or rearrange pieces for more even defrosting. Shield any warm areas with small pieces of foil.

### Time Defrost

Allows you to defrost for a selected length of time. See the Defrosting Guide for suggested times. (Auto Defrost explained in the About the auto feature section.)

- 1 Press the **TIME DEFROST** pad twice.
- 2 Enter defrosting time.
- 3 Press the **START** pad.
- 4 Turn food over when the oven signals.
- 5 Press the **START** pad.

Power level is automatically set at 3, but can be changed. You can defrost small items quickly by raising the power level after entering the time. **Power level 7** cuts the total defrosting time in about half; **power level 10** cuts the total time to approximately 1/3. However, food will need more frequent attention than usual.

### Defrosting Tips

- Foods frozen in paper or plastic can be defrosted in the package. Closed packages should be slit, pierced or vented **AFTER** food has partially defrosted. Plastic storage containers should be partially uncovered.
- Family-size, prepackaged frozen dinners can be defrosted and microwaved. If the food is in a foil container, transfer it to a microwave-safe dish.
- Foods that spoil easily should not be allowed to sit out for more than one hour after defrosting. Room temperature promotes the growth of harmful bacteria.
- For more even defrosting of larger foods, such as roasts, use Auto Defrost. Be sure large meats are completely defrosted before cooking.
- When defrosted, food should be cool but softened in all areas. If still slightly icy, return to the microwave very briefly, or let it stand a few minutes.

### Defrosting Guide

Food	Time	Comments
<b>Breads, Cakes</b> Bread, buns or rolls (1 piece) Sweet rolls (approx. 12 oz.)	1/2 min. 3 to 6 min.	Rearrange after half the time.
<b>Fish and Seafood</b> Fillets, frozen (1 lb.) Shellfish, small pieces (1 lb.)	9 to 12 min. 3 to 7 min.	Place block in casserole. Turn over and break up after half the time.
<b>Fruit</b> Plastic pouch – 1 or 2 (10-oz. package)	3 to 7 min.	
<b>Meat</b> Bacon (1 lb.) Franks (1 lb.)  Ground meat (1 lb.) Roast: beef, lamb, veal, pork Steaks, chops and cutlets	3 to 6 min. 3 to 6 min.  5 to 8 min. per lb. 11 to 16 min. per lb. 5 to 10 min. per lb.	Place unopened package in oven. Let stand 5 minutes after defrosting. Place unopened package in oven. Microwave just until franks can be separated. Let stand 5 minutes, if necessary, to complete defrosting. Turn meat over after first half of time. Use <b>power level 1</b> . Place unwrapped meat in cooking dish. Turn over after first half of time and shield warm areas with foil. After second half of time, separate pieces with table knife. Let stand to complete defrosting.
<b>Poultry</b> Chicken, broiler-fryer, cut up (2½ to 3 lbs.)  Chicken, whole (2½ to 3 lbs.)  Cornish hen  Turkey breast (4 to 6 lbs.)	15 to 22 min.  20 to 28 min.  9 to 16 min. per lb.  5 to 10 min. per lb.	Place wrapped chicken in dish. Unwrap and turn over after first half of time. After second half of time, separate pieces and place in cooking dish. Microwave 2 to 4 minutes more, if necessary. Let stand a few minutes to finish defrosting. Place wrapped chicken in dish. After half the time, unwrap and turn chicken over. Shield warm areas with foil. To complete defrosting, run cold water in the cavity until giblets can be removed. Place unwrapped hen in the oven breast-side-up. Turn over after first half of time. Run cool water in the cavity until giblets can be removed. Place unwrapped breast in microwave-safe dish breast-side-down. After first half of time, turn breast-side-up and shield warm areas with foil. Defrost for second half of time. Let stand 1 to 2 hours in refrigerator to complete defrosting.

## Using the microwave sensor cooking features.

The Sensor Features detect the increasing humidity released during cooking. The oven automatically adjusts the cooking time to various types and amounts of food.

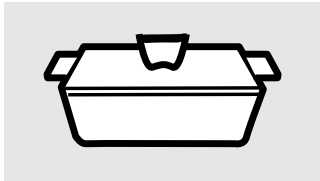

Covered

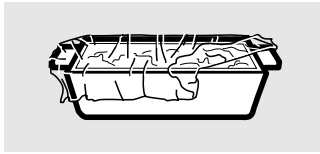

Vented



Dry off dishes so they don't mislead the sensor.

### Sensor Cooking

- The proper containers and covers are essential for best sensor cooking.
- Always use microwave-safe containers and cover them with lids or vented plastic wrap. Never use tight sealing plastic containers—they can prevent steam from escaping and cause food to overcook.
- Be sure the outside of the cooking containers and the inside of the microwave oven are dry before placing food in the oven. Beads of moisture turning into steam can mislead the sensor.

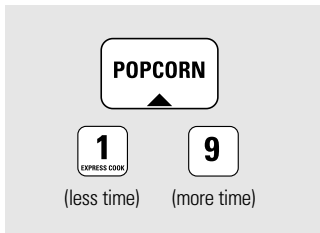

Use only with prepackaged microwave popcorn weighing 1.75 to 3.5 ounces.

### Popcorn

#### To use the Popcorn feature:

- 1 Follow package instructions, using Time Cook if the package is less than 1.75 ounces or larger than 3.5 ounces. Place the package of popcorn in the center of the microwave.
- 2 Press the **POPCORN** pad. The oven starts immediately.

If you open the door while POP is displayed, **ERROR** will appear. Close the door, press the **CLEAR/OFF** pad and begin again.

#### How to Adjust the Popcorn Program to Provide a Shorter or Longer Cook Time:

If you find that the brand of popcorn you use underpops or overcooks consistently, you can add or subtract 20–30 seconds to the automatic popping time.

#### To add time:

After pressing the **POPCORN** pad, press the **9** pad immediately after the oven starts for an extra 20 seconds. Press the **9** pad again to add another 10 seconds (total 30 seconds additional time).

#### To subtract time:

After pressing the **POPCORN** pad, press the **1** pad immediately after the oven starts for 20 seconds less cooking time. Press the **1** pad again to reduce cooking time another 10 seconds (total 30 seconds less time).





(less time)



(more time)

## Reheat

The Reheat feature reheats single servings of previously cooked foods or a plate of leftovers.

- 1 Place covered food in the oven. Press the **REHEAT** pad. The oven starts immediately.
- 2 The oven signals when steam is sensed and the time remaining begins counting down.

Do not open the oven door until time is counting down. If the door is opened, close it and press the **START** pad immediately.

After removing food from the oven, stir, if possible, to even out the temperature. If the food is not hot enough, use Time Cook to reheat for more time. Reheated foods may have wide variations in temperature. Some areas may be extremely hot.

**Some foods not recommended for use with REHEAT—it is best to use Time Cook for these foods:**

- Bread products.
- Foods that must be reheated uncovered.
- Foods that need to be stirred or rotated.
- Foods calling for a dry look or crisp surface after reheating.

### How to Change the Automatic Settings:

To reduce time by 10%:

Press the **1** pad after the feature pad.

To add 10% to cooking time:

Press the **9** pad after the feature pad.



(less time)



(more time)

## Potato

The Potato feature cooks 1/2–2 lbs. of potatoes.

- 1 Pierce skin with fork and place potatoes on the turntable. If cooking three or more potatoes, arrange in a star pattern.
- 2 Press the **POTATO** pad. The oven starts immediately. The oven signals when steam is sensed and the time remaining begins counting down.

Do not open the oven door until time is counting down. If the door is opened, close it and press the **START** pad immediately.

If food is not done enough, use Time Cook to cook for more time.

## Using the microwave convenience cooking features.

Drinks heated with the Beverage feature may be very hot. Remove the container with care.



### Beverage

Press the **BEVERAGE** pad to heat a cup of coffee or other beverage.

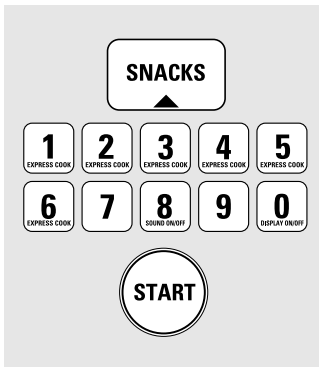

### Snacks

The Snacks feature automatically sets the microwaving times and power levels to warm a variety of snack foods.

- 1 Press the **SNACKS** pad.
- 2 Select snack type 1–6 (see the Snacks Guide).
- 3 Enter the number of items or the food weight in ounces.
- 4 Press the **START** pad.

**Hint:** You can press and hold the **SNACKS** pad during cooking to display the remaining microwaving time.

### Snacks Guide

Food Type	Quantity or Weight
1 Bread, rolls, muffins	1 to 4
2 Sandwiches	1 to 2
3 Pizza (leftover slices)	1 to 4
4 Dessert toppings	1 to 4
5 Soup	8 to 40 oz.
6 Cheese dip	4 to 16 oz.

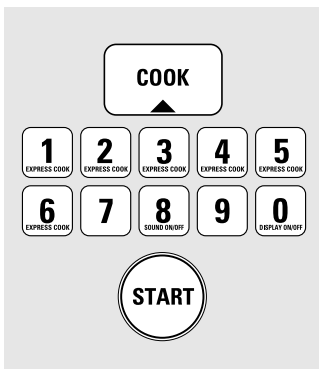

### Cook

The Cook feature automatically sets the cooking times and power levels for a variety of foods.

- 1 Press the **COOK** pad.
- 2 Select food type 1–9 (see the Cook Guide below).

3 Enter weight in ounces.

4 Press the **START** pad.

**Hint:** Press and hold the **COOK** pad during cooking to display the remaining cook time.

### Cook Guide

Food Type	Weight	Comments
1 Canned Vegetables	4 to 20 oz.	Use microwave-safe casserole or bowl. Cover with lid or vented plastic wrap.
2 Frozen Vegetables	4 to 16 oz.	Use microwave-safe casserole or bowl. Follow package instructions for adding water. Cover with lid or vented plastic wrap.
3 Fresh Vegetables	4 to 16 oz.	Use microwave-safe casserole or bowl. Add 2 tablespoons water for each serving. Cover with lid or vented plastic wrap.
4 Potatoes	8 to 40 oz.	Pierce skin with fork. Place potatoes on the turntable.
5 Fish	4 to 16 oz.	Use oblong, square or round dish. Cover with vented plastic wrap.
6 Chicken Pieces	4 to 40 oz.	Use oblong, square or round dish. Cover with vented plastic wrap or wax paper.
7 Ground Meat (beef, pork, turkey)	8 to 48 oz.	Use round casserole dish. Crumble meat into dish. Cover with lid or vented plastic wrap.
8 Bacon	2 to 10 oz.	Layer strips on a plate, 4 to a layer. Cover each layer with a paper towel.
9 Pizza (frozen, microwaveable)	4 to 16 oz.	Follow package instructions to prepare pizza for microwaving.

# Using the microwave auto feature.

ge.com

The Defrost Auto/Time feature gives you two ways to defrost frozen foods. Press **AUTO DEFROST** once for Auto Defrost or twice for Time Defrost.

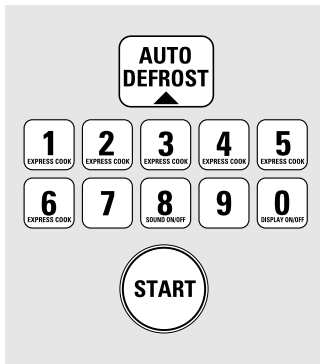

## Auto Defrost

Use Auto Defrost for meat, poultry and fish up to 6 pounds. Use Time Defrost for most other frozen foods.

Auto Defrost automatically sets the defrosting times and power levels to give even defrosting results for meats, poultry and fish.

- 1 Press the **AUTO DEFROST** pad once.
- 2 Using the Conversion Guide at right, enter food weight. For example, press pads **1** and **2** for 1.2 pounds (1 pound, 3 ounces).
- 3 Press **START**.

Time Defrost is explained in the *Using the timed microwave features* section.

- Remove meat from package and place on microwave-safe dish.
- Twice during defrost, the oven signals **TURN**. At each **TURN** signal, turn the food over. Remove defrosted meat or shield warm areas with small pieces of foil.
- After defrosting, most meats need to stand 5 minutes to complete defrosting. Large roasts should stand for about 30 minutes.

## Conversion Guide

If the weight of food is stated in pounds and ounces, the ounces must be converted to tenths (.1) of a pound.

Weight of Food in Ounces	Enter Food Weight (tenths of a pound)
1-2	.1
3	.2
4-5	.3
6-7	.4
8	.5
9-10	.6
11	.7
12-13	.8
14-15	.9

Safety Instructions

Operating Instructions

Care and Cleaning

Troubleshooting Tips

Consumer Support

## Other microwave features.

Remember: To remind you that you have food in the oven, the oven will beep once a minute with the oven door closed or press the **CLEAR/OFF** pad.

### Clock

Press to enter the time of day or to check the time of day while microwaving.

- 1 Press the **CLOCK** pad.
- 2 Enter time of day.
- 3 Press the **START** pad or the **CLOCK** pad.

### Display On/Off

To turn the clock display on or off, press and hold the **0** pad for about 3 seconds. The Display On/Off feature cannot be used while a cooking feature is in use.

### Delay Start

Delay Start allows you to set the

- 3 Select your desired program.
- 4 Press the **START** pad.

The Delay Start time will be displayed. The oven will automatically start at the delayed time.

The time of day may be displayed by pressing the **CLOCK** pad.

**NOTE:** You cannot use **DELAY START** with **BORN** or **REHEAT**.

### Sound On/Off

To turn the beeper sound on or off, press and hold the **8** pad for about 3 seconds.

5  
PRESS COOK  
0  
MUTE/ON/OFF

1  
EXPRESS COOK

4

START

8

SOUND ON/OFF



### Child Lockout

You may lock the control panel to prevent the microwave from being accidentally started or used by children.

To lock or unlock the controls, press and hold the **CLEAR/OFF** pad for about 3 seconds.

When the control panel is locked, an **L** will be displayed to the extreme right.



MIN/SEC



MIN/SEC

### Kitchen Timer

Kitchen Timer operates as a minute timer and can be used at any time, even when the oven is operating.

#### How to use as a minute timer:

- 1 Press the **KITCHEN TIMER MIN/SEC** pad.
- 2 Enter time you want to count down.
- 3 Press the **KITCHEN TIMER MIN/SEC** pad.

When time is up, the oven will signal. To turn off the timer signal, press the **KITCHEN TIMER MIN/SEC** pad.

**NOTE:** The timer indicator will be lit while the timer is operating.

To cancel the timer during the countdown, press the **KITCHEN TIMER MIN/SEC** pad.



REMINDER



### Reminder

The Reminder feature can be used like an alarm clock, and can be used at any time, even when the oven is operating. The Reminder time can be set up to 12 hours later.

- 1 Press the **DELAY START** pad.
- 2 Enter the time you want the oven to remind you. (Be sure the microwave clock shows the correct time of day.)
- 3 Press the **START** pad. When Reminder signal occurs, press the **DELAY START** pad to turn it off. The Reminder time may be displayed by pressing the **DELAY START** pad.

**NOTE:** REM will remain on the display to show that the Reminder is set until the Reminder time is reached and the door is opened or **CLEAR/OFF** is pressed.

## Using the lower oven controls.

Throughout this manual, features and appearance may vary from your model. Your model may have one of the following controls.

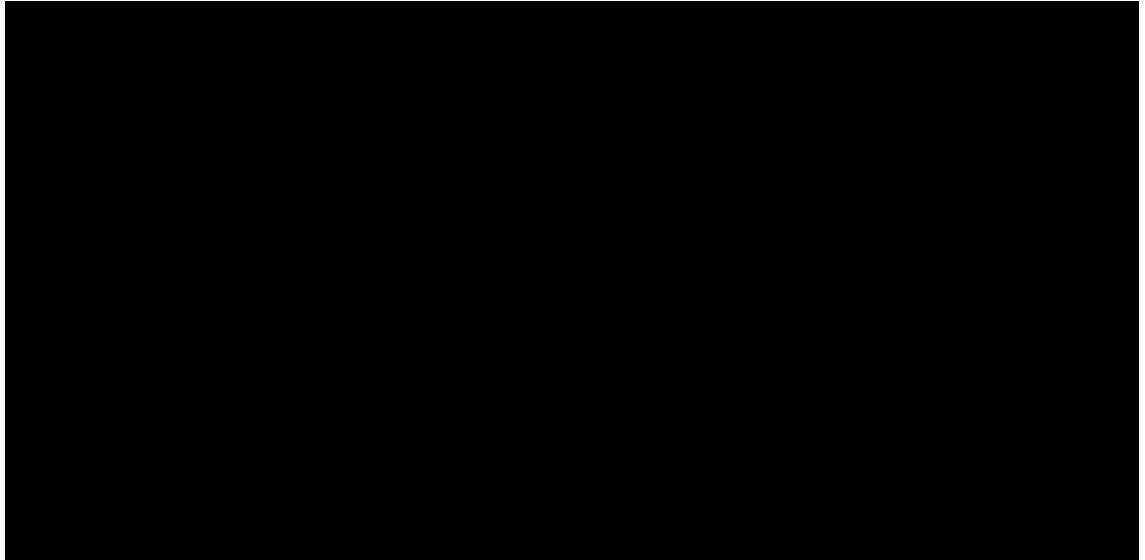
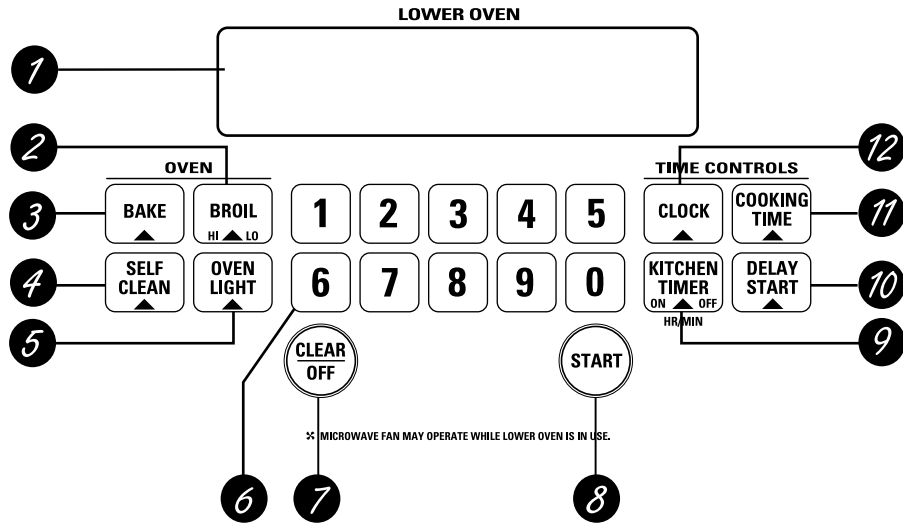



## Lower Oven Control, Clock and Timer Features and Settings

- 1** **Display**  
Shows the time of day, oven temperature, whether the oven is in the bake, broil or self-cleaning mode and the times set for the timer or automatic oven operations.

**NOTE:** The time on the lower oven display is shown in hours and minutes (1:30 is one hour, 30 minutes). On the microwave oven, time is shown in minutes and seconds (1:30 is one minute, 30 seconds).

**If "F- and a number or letter" flash in the display and the oven control signals, this indicates a function error code.** Press the **CLEAR/OFF** pad. Allow the oven to cool for one hour. Put the oven back into operation. If the function error code repeats, disconnect the power to the oven and call for service.

**If your oven was set for a timed oven operation and a power outage occurred, the clock and all programmed functions must be reset. The time of day (may be incorrect) will flash in the display when there has been a power outage.**
- 2** **BROIL HI/LO Pad**  
Press to select the broil function.
- 3** **BAKE Pad**  
Press to select the bake function.
- 4** **SELF CLEAN Pad**  
Press to select the self-cleaning function. See the *Using the self-cleaning lower oven* section.
- 5** **OVEN LIGHT Pad**  
Press to turn the oven light on or off.
- 6** **Number Pads**  
Use to set any function requiring numbers such as the time of day on the clock, the timer, the oven temperature, the start time and length of operation for timed baking and self-cleaning.
- 7** **CLEAR/OFF Pad**  
Press to cancel **ALL** oven operations except the clock and timer.
- 8** **START Pad**  
Must be pressed to start any cooking or cleaning function.
- 9** **KITCHEN TIMER ON/OFF Pad**  
Press to select the timer feature.
- 10** **DELAY START Pad**  
Use along with **COOKING TIME** or **SELF CLEAN** pads to set the oven to start and stop automatically at a time you set.
- 11** **COOKING TIME Pad**  
Press and then press the number pads to set the amount of time you want your food to cook. The oven will shut off automatically when the cooking time has run out, unless the Cook and Hold feature was set.
- 12** **CLOCK Pad**  
Press before setting the clock.

## Special features of your lower oven control.

Your new touch pad control has additional features that you may choose to use. The following are the features and how you may activate them.

The special feature modes can only be activated while the display is showing the time of day. They remain in the control's memory until the steps are repeated.

When the display shows your choice, press the **START** pad. The special features will remain in memory after a power failure.

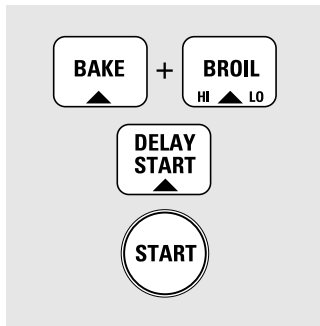

### 12-Hour Shutoff

With this feature, should you forget and leave the oven on, the control will automatically turn off the oven after 12 hours during baking functions or after 3 hours during a broil function.

If you wish to turn **OFF** this feature, follow the steps below.

- 1 Press the **BAKE** and **BROIL HI/LO** pads at the same time for 3 seconds until the display shows **SF**.

- 2 Press the **DELAY START** pad until **no shdn** (no shutoff) appears in the display.
- 3 Press the **START** pad to activate the no shutoff and leave the control set in this special features mode.

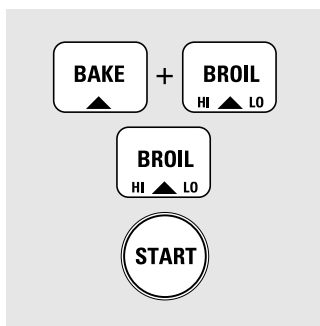

### Fahrenheit or Centigrade Temperature Selection

Your oven control is set to use the Fahrenheit temperature selections, but you may change this to use the Centigrade selections.

- 1 Press the **BAKE** and **BROIL HI/LO** pads at the same time for 3 seconds until the display shows **SF**.
- 2 Press the **BROIL HI/LO** pad. The display will show **F** (Fahrenheit).

- 3 Press the **BROIL HI/LO** pad again. The display will show **C** (Centigrade).
- 4 Press the **START** pad to activate the temperature selection.

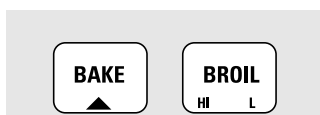

### Control Lockout

Your control will allow you to lock down the touch pads so they cannot be activated.

- 1 Press the **BAKE** and **BROIL HI/LO** pads at the same time for 3 seconds until the display shows **SF**.

Press the **SELF CLEAN** pad. The display will show **LOC OFF**.

Press the **SELF CLEAN** pad again. The display will show **LOC ON**.

- 3 Press the **START** pad to activate the control lockout feature and leave the control set in this special features mode.

2. Press the **START** pad when the display shows **LOC OFF**.

**NOTE:** The control lockout mode will not affect the **CLOCK**, **KITCHEN TIMER ON/OFF** and **OVEN LIGHT** touch pads.



### Tones at the End of a Timed Cycle

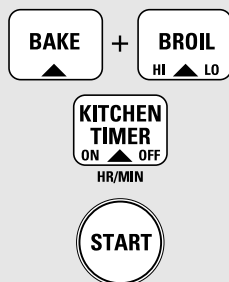

At the end of a timed cycle, 3 short beeps will sound followed by one beep every 6 seconds until the **CLEAR/OFF** pad is pressed. This continuous 6-second beep may be canceled.

To cancel the 6-second beep:

- 1 Press the **BAKE** and **BROIL HI/LO** pads at the same time for 3 seconds until the display shows **SF**.

- 2 Press the **KITCHEN TIMER ON/OFF** pad. The display shows **CON BEEP** (continuous beep). Press the **KITCHEN TIMER ON/OFF** pad again. The display shows **BEEP**. (This cancels the one beep every 6 seconds.)

- 3 Press the **START** pad.

### 12-Hour, 24-Hour or Clock Blackout

Your control is set to use a 12-hour clock.

If you would prefer to have a 24-hour military time clock or black out the clock display, follow the steps below.

- 1 Press the **BAKE** and **BROIL HI/LO** pads at the same time for 3 seconds until the display shows **SF**.

- 2 Press the **CLOCK** pad once. The display will show **12 hr**. If this is the choice you want, press the **START** pad.

Press the **CLOCK** pad again to change to the 24-hour military time clock. The display will show **24 hr**. If this is the choice you want, press the **START** pad.

Press the **CLOCK** pad again to black out the clock display. The display will show **OFF**. If this is the choice you want, press the **START** pad.

**NOTE:** If the clock is in the black-out mode, you will not be able to use the Delay Start function.

### Cook and Hold

Your new control has a cook and hold feature that keeps cooked foods warm for up to 3 hours after Timed Baking or Roasting is finished.

**NOTE:** This feature can only be programmed to work with Timed Baking or Roasting. (See the Using the lower oven timed baking and roasting features section.) After Timed Baking or Roasting has automatically stopped, the programmed Cook and Hold will automatically start.

To activate this feature for use after Timed Baking or Roasting, follow the steps below.

- 1 Press the **BAKE** and **BROIL HI/LO** pads at the same time for 3 seconds until the display shows **SF**.

- 2 Press the **COOKING TIME** pad. The display will show **Hld OFF**.

Press the **COOKING TIME** pad again to activate the feature. The display will show **Hld ON**.

- 3 Press the **START** pad to activate the cook and hold feature and leave the control set in this special features mode.

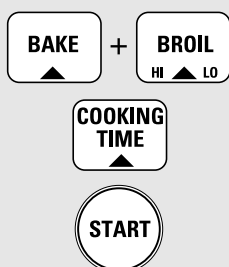

## Using the lower oven

To avoid possible burns, please

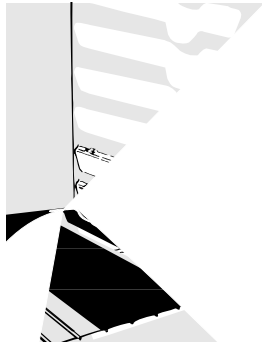

position before you turn the oven on.

ks, so that when supports, they will completely out, and

ving cookware, bump on the

**To remove a shelf,** pull it toward you, tilt the front end up and pull it out.

**To replace,** place the end of the shelf (stop-locks) on the support, tilt up the front and push the shelf in.

**NOTE:** 30" ovens (shown) have 6 shelf positions. 27" ovens have 4 shelf positions.

You can use aluminum foil to line the broiler pan and broiler grid. However, you must mold the foil tightly to the grid and cut slits in it just like the grid.

Without the slits, the foil will prevent fat and meat juices from draining into the broiler pan. The juices could become hot enough to catch on fire. If you do not cut the slits, you are essentially frying, not broiling.

Do not use aluminum foil on the bottom of the oven.

Never entirely cover a shelf with aluminum foil. This will disturb the heat circulation and result in poor baking.

A smaller sheet of foil may be used to catch a spillover by placing it on a lower shelf several inches below the food.

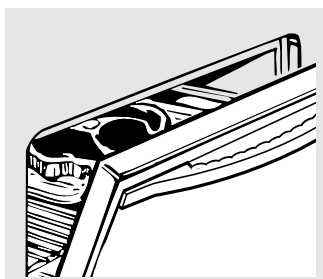

If your oven is connected to 208 volts, rare steaks may be broiled by preheating the broiler and positioning the oven shelf one position higher.

## How to Set the Oven for Broiling

Leave the door open to the broil stop position. The door stays open by itself, yet the proper temperature is maintained in the oven.

**NOTE:** Food can be broiled with the door closed, but it may not brown as well because the oven heating element will cycle on and off.

- 1 Place the meat or fish on the broiler grid in the broiler pan.
- 2 Follow suggested shelf positions in the *Broiling Guide*.

The size, weight, thickness, starting temperature and your preference for doneness will affect

broiling times. This guide is based on meats at refrigerator temperature.

- 3 Press the **BROIL HI/LO** pad once for **HI Broil**.

To change to **LO Broil**, press the **BROIL HI/LO** pad again.

- 4 Press the **START** pad.
- 5 When broiling is finished, press the **CLEAR/OFF** pad.

## Broiling Guide

Food	Quantity and/or Thickness	27" Ovens Shelf Position	27" Ovens First Side Time (min.)	27" Ovens Second Side Time (min.)	30" Ovens Shelf Position	30" Ovens First Side Time (min.)	30" Ovens Second Side Time (min.)	Comments
<b>Ground Beef</b> Well Done	1 lb. (4 patties) 1/2 to 3/4" thick	C	10	7	E E	10 10	7 9	Space evenly. Up to 8 patties take about the same time.
<b>Beef Steaks</b>								
Rare†	1" thick	C	6	5	E	8	6	Steaks less than 1" thick cook through before browning. Pan frying is recommended. Slash fat.
Medium	1 to 1½ lbs.	C	8	6	E	10	8	
Well Done		C	12	11	E	12	10	
Rare†	1½" thick	C	10	7-8	E	10	8	Pan frying is recommended. Slash fat.
Medium	2 to 2½ lbs.	C	15	14-16	E	15	14-16	
Well Done		C	25	20-25	E	25	20-25	
<b>Chicken</b>	1 whole 2 to 2½ lbs., split lengthwise	A	35	10-15	C	25	10	Reduce time about 5 to 10 minutes per side for cut-up chicken. Brush each side with melted butter. Broil skin-side-down first.
<b>Loxster Tails</b>	2-4 6 to 8 oz. each	B	13-16	Do not turn over.	C	13-16	Do not turn over.	Cut through back of shell. Spread open. Brush with melted butter before broiling and after half of broiling time.
<b>Fish Fillets</b>	1/4 to 1/2" thick	C	5	5	E	5	5	Handle and turn very carefully. Brush with lemon butter before and during cooking, if desired. Preheat broiler to increase browning.
<b>Ham Slices</b> (precooked)	1" thick	B	8	8	D	8	8	Increase time 5 to 10 minutes per side for 1½" thick or home-cured ham.
<b>Pork Chops</b>	2 (1/2" thick)	C	10	10	E	10	10	Slash fat.
Well Done	2 (1" thick) about 1 lb.	B	13	13	D	15	15	
<b>Lamb Chops</b>								Slash fat.
Medium	2 (1" thick) about 10	C	10	9	E	10	9	
Well Done	to 12 oz.	C	12	10	E	12	10	
Medium	2 (1½" thick) about 1 lb.	C	14	12	E	14	12	
Well Done		B	17	12-14	E	17	12-14	

† The U.S. Department of Agriculture says "Rare beef is popular, but you should know that cooking it to only 140°F means some food poisoning organisms may survive." (Source: *Safe Food Book, Your Kitchen Guide*, USDA Rev. June 1985.)

<b><i>Safety Instructions</i></b>
<b><i>Operating Instructions</i></b>
<b><i>Care and Cleaning</i></b>
<b><i>Troubleshooting Tips</i></b>
<b><i>Consumer Support</i></b>

## ***Using the lower oven clock and timer.***

---

### ***To Set the Clock***

The clock must be set to the correct time of day for the automatic oven

# Using the lower oven timed baking and roasting features. (on some models)

ge.com

**NOTE:** Foods that spoil easily—such as milk, eggs, fish, stuffings, poultry and pork—should not be allowed to sit for more than 1 hour before or after cooking. Room temperature promotes the growth of harmful bacteria. Be sure that the oven light is off because heat from the bulb will speed harmful bacteria growth.

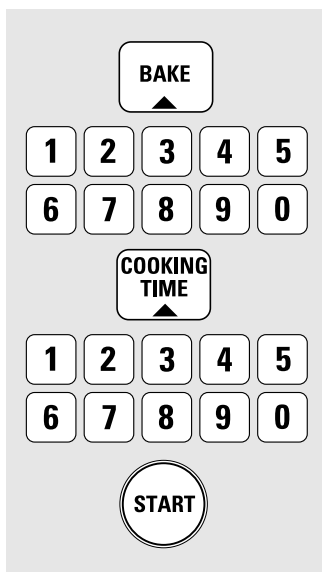

## How to Set an Immediate Start and Automatic Stop

The oven will turn on immediately and cook for a selected length of time. At the end of the cooking time, the oven will turn off automatically.

Make sure the clock shows the correct time of day.

- 1 Press the **BAKE** pad.
- 2 Using the number pads, enter the desired temperature.
- 3 Press the **COOKING TIME** pad.

**NOTE:** If your recipe requires preheating, you may need to add additional time to the length of the cooking time.

- 4 Using the number pads, enter the desired baking time. Maximum time that can be entered in minutes is 59. Cooking times more than 59 minutes should be changed to hours

and minutes. For example, enter 90 minutes as 1 hr. 30 minutes. The oven temperature and the cooking time that you entered will be displayed.

- 5 Press the **START** pad.

The display shows the oven temperature that you set and the cooking time countdown. The display starts changing once the temperature reaches 100°F.

The oven will continue to cook for the programmed amount of time, then shut off automatically, unless the Cook and Hold feature was set. See the *Special features of your lower oven control* section.

Press the **CLEAR/OFF** pad to clear the display.

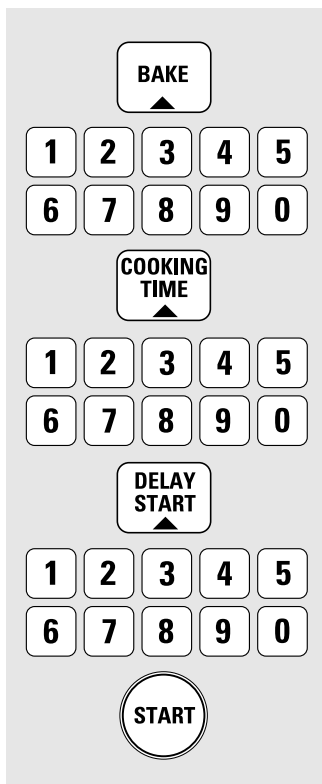

## How to Set a Delayed Start and Automatic Stop

You can set the oven control to delay-start the oven, cook for a specific length of time and then turn off automatically.

Make sure the clock shows the correct time of day.

- 1 Press the **BAKE** pad.
- 2 Using the number pads, enter the desired temperature.
- 3 Press the **COOKING TIME** pad.

**NOTE:** If your recipe requires preheating, you may need to add additional time to the length of the cooking time.

- 4 Using the number pads, enter the desired baking time. Maximum time that can be entered in minutes is 59. Cooking times more than 59 minutes should be changed to hours and minutes. For example, enter 90 minutes as 1 hr. 30 minutes. The oven temperature and the cooking time that you entered will be displayed.

- 5 Press the **DELAY START** pad.

- 6 Using the number pads, enter the time of day you want the oven to turn on and start cooking.

- 7 Press the **START** pad.

**NOTE:** An attention tone will sound if you are using timed baking and do not press the **START** pad after entering the baking temperature.

If you would like to check the times you have set, press the **DELAY START** pad to check the start time you have set or press the **COOKING TIME** pad to check the length of cooking time you have set.

When the oven turns on at the time of day you have set, the display will show the changing temperature (starting at 100°F) and the cooking time countdown. The display starts changing once the temperature reaches 100°F.

The oven will continue to cook for the programmed amount of time, then shut off automatically, unless the Cook and Hold feature was set. See the *Special features of your lower oven control* section.

Press the **CLEAR/OFF** pad to clear the display.

## Adjust the lower oven thermostat—Do it yourself!

You may find that your new oven cooks differently than the one it replaced. Use your new oven for a few weeks to become more familiar with it. If you still think your new oven is too hot or too cold, you can adjust the thermostat yourself.

Do not use thermometers, such as those found in grocery stores, to check the temperature setting of your oven. These thermometers may vary 20–40 degrees.

**NOTE:** This adjustment will only affect baking and roasting temperatures; it does not affect broiling or self-cleaning temperatures. The adjustment will be retained in memory after a power failure.

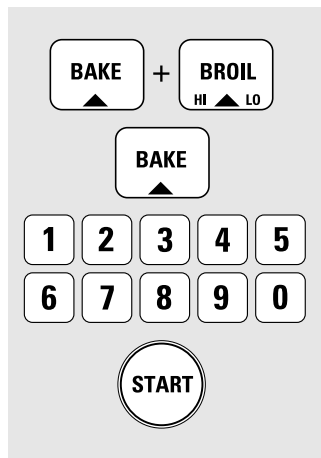

### To Adjust the Thermostat

- 1 Press the **BAKE** and **BROIL HI/LO** pads at the same time for 3 seconds until the display shows **SF**.
- 2 Press the **BAKE** pad. A two digit number shows in the display.  
Press **BAKE** once to decrease (-) the oven temperature, or twice to increase (+).
- 3 The oven temperature can be adjusted up to (+) 35°F hotter or (-) 35°F cooler. Press the number pads the same way you read them. For example, to change the oven temperature 15°F, press **1** and **5**.
- 4 When you have made the adjustment, press the **START** pad to go back to the time of day display. Use your oven as you would normally.

## The type of margarine will affect baking performance!

Most recipes for baking have been developed using high-fat products such as butter or margarine (80% fat). If you decrease the fat, the recipe may not give the same results as with a higher-fat product.

Recipe failure can result if cakes, pies, pastries, cookies or candies are made with low-fat spreads. The lower the fat content of a spread product, the more noticeable these differences become.

Federal standards require products labeled “margarine” to contain at least 80% fat by weight. Low-fat spreads, on the other hand, contain less fat and more water. The high moisture content of these spreads affect the texture and flavor of baked goods. For best results with your old favorite recipes, use margarine, butter or stick spreads containing at least 70% vegetable oil.

# Using the self-cleaning lower oven.

ge.com

The oven door must be closed and all controls must be set correctly for the cycle to work properly.

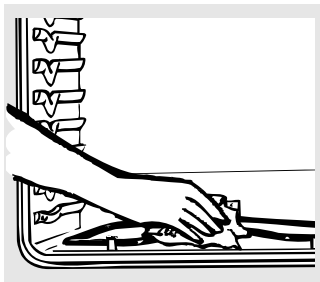

Wipe up heavy soil on the oven bottom.

## Before a Clean Cycle

We recommend venting your kitchen with an open window or using a ventilation fan or hood during the first self-clean cycle.

Remove the broiler pan, broiler grid, all cookware and any aluminum foil from the oven.

The oven shelves can be self-cleaned, but they will darken, lose their luster and become hard to slide.

Do not use abrasives or oven cleaners. Clean the top, sides and outside of the oven door with soap and water.

Make sure the oven light bulb cover (on some models) is in place and the oven light is off.

**IMPORTANT:** The health of some birds is extremely sensitive to the fumes given off during the self-cleaning cycle of any oven. Move birds to another well ventilated room.

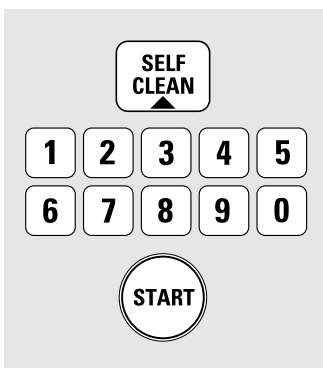

## How to Set the Oven for Cleaning

- 1 Press the **SELF CLEAN** pad.
- 2 Using the number pads, enter the desired clean time, if a time other than 4 hours is needed.

Clean cycle time is normally 4 hours. You can change the clean time to any time between 3 hours and 5 hours, depending on how dirty your oven is.

- 3 Press the **START** pad.

The door locks automatically. The display will show the clean time remaining. It will not be possible to open the oven door until the temperature drops below the lock temperature and the **LOCKED** or **LOCKED DOOR** light goes off.

When the **LOCKED** or **LOCKED DOOR** light goes off, you will be able to open the door.

- The word **LOCKED** or **LOCKED DOOR** will flash and the oven control will signal if you set the clean cycle and forget to close the oven door.
- To stop a clean cycle, press the **CLEAR/OFF** pad. When the **LOCKED** or **LOCKED DOOR** light goes off, indicating the oven has cooled below the locking temperature, you will be able to open the door.

## Using the self-cleaning lower oven.

The oven door must be closed and all controls must be set correctly for the cycle to work properly.

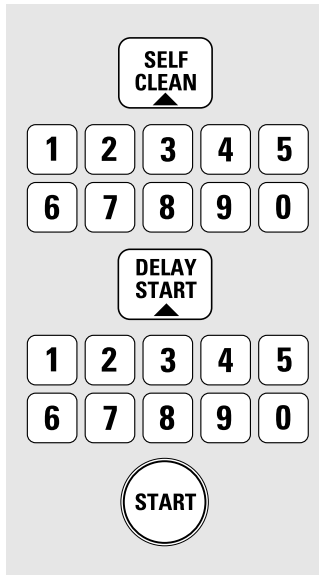

### How to Delay the Start of Cleaning *(available on JKP86 models only)*

- 1 Press the **SELF CLEAN** pad.
- 2 Using the number pads, enter the desired clean time.
- 3 Press the **DELAY START** pad. The earliest start time you can set will appear in the display.
- 4 Using the number pads, enter the time of day you want the clean cycle to start.
- 5 Press the **START** pad.

The door locks automatically. The display will show the start time. It will not be possible to open the oven door until the temperature drops below the lock temperature and the **LOCKED** or **LOCKED DOOR** light goes off.

When the **LOCKED** or **LOCKED DOOR** light goes off, you will be able to open the door.

### After a Clean Cycle

You may notice some white ash in the oven. Wipe it up with a damp cloth after the oven cools.

*If white spots remain, remove them with a soap-filled steel wool pad and rinse thoroughly with a vinegar and water mixture.*

These deposits are usually a salt residue that cannot be removed by the clean cycle.

If the oven is not clean after one clean cycle, repeat the cycle.

- You cannot set the oven for cooking until the oven is cool enough for the door to unlock.
- While the oven is self-cleaning, you can press the **CLOCK** pad to display the time of day. To return to the clean countdown, press the **COOKING TIME** pad.
- If the shelves become hard to slide, apply a small amount of vegetable oil or cooking oil to a paper towel and wipe the edges of the shelves with the paper towel.



Be sure electrical power is off and all surfaces are cool before cleaning any part of the cooking center.

## How to Remove Protective Shipping Film and Packaging Tape

Carefully grasp a corner of the protective shipping film with your fingers and slowly peel it from the appliance surface. Do not use any sharp items to remove the film. Remove all of the film before using the appliance for the first time.

To assure no damage is done to the finish of the product, the safest way to remove the adhesive from packaging tape on new appliances is an application of a household liquid dishwashing detergent. Apply with a soft cloth and allow to soak.

**NOTE:** The adhesive must be removed from all parts. It cannot be removed if it is baked on.

## Microwave Oven

Do not use a commercial oven cleaner on any part of your microwave oven.

### Removable Turntable and Turntable Support

To prevent breakage, do not place the turntable into water just after cooking. Wash it carefully in warm, sudsy water or in the dishwasher.

The turntable and support can be broken if dropped. Remember, do not operate the microwave oven without the turntable and support in place.

To replace the support, place its center post in the hole. Turn the support around until it seats into place.

### Inside

Keep the microwave oven clean and sweet-smelling. Opening the oven door a few minutes after cooking helps air out the interior. An occasional thorough wiping with a solution of baking soda and water keeps the interior fresh.

Spills and spatters are easy to remove from walls and floor if they are wiped up soon after the food is removed. Some spatters wipe up with a paper towel, some may require a damp cloth. Remove greasy spatters with a sudsy cloth, then rinse and dry.

*Do not clean with metal scouring pads. Pieces can break off the pad, causing electrical shock.*

Wipe up spatters on the window on the inside of the door daily. When the window is soiled, wash it with a damp cloth. Rinse thoroughly and dry.

Wipe metal and plastic parts on the inside of the door frequently. Use a damp cloth to remove all soil.

Do not use abrasives, such as cleaning powders or steel and plastic pads. They may mar the surface.

### Outside

Clean the outside of the microwave oven with soap and a damp cloth, then rinse with a damp cloth and dry. Wipe the window clean with a damp cloth. Chrome is best wiped with a damp cloth and then with a dry towel.

### Door Surface

When cleaning surfaces of door and oven that come together on closing the door, use only mild, non-abrasive soaps or detergents applied with a sponge or soft cloth.

## Care and cleaning of the cooking center.

### Lift-Off Oven Door

**The door is very heavy. Be careful when removing and lifting the door.**

*Do not lift the door by the handle.*

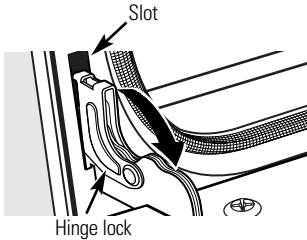

*Pull hinge locks down to unlock*

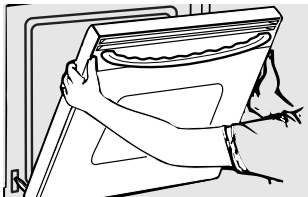

*Removal position*

#### To remove the door:

- 1 Fully open the door.
- 2 Pull the hinge locks down toward the door frame, to the unlocked position. A tool, such as a small flat-blade screwdriver, may be required.
- 3 Firmly grasp both sides of the door at the top.
- 4 Close door to the door removal position, which is halfway between the broil stop position and fully closed.
- 5 Lift door up and out until the hinge arm is clear of the slot.

#### To replace the door:

- 1 Firmly grasp both sides of the door at the top.
- 2 With the door at the same angle as the removal position, seat the indentation of the hinge arm into the bottom edge of the hinge slot. The notch in the hinge arm must be fully seated into the bottom of the slot.
- 3 Fully open the door. If the door will not fully open, the indentation is not seated correctly in the bottom edge of the slot.
- 4 Push the hinge locks up against the front frame of the oven cavity, to the locked position.

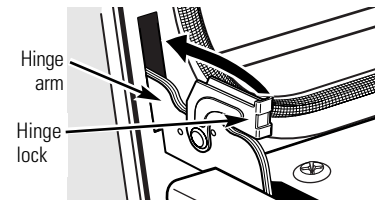
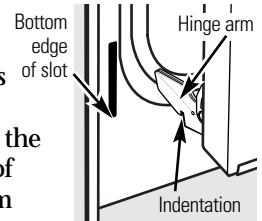

*Push hinge locks up to lock*

- 5 Close the oven door.

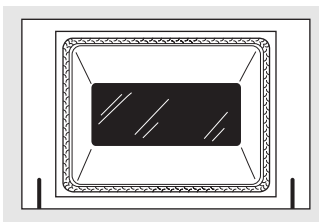

*Do not rub or clean the door gasket—it has an extremely low resistance to abrasion.*

*If you notice the gasket becoming worn, frayed or damaged in any way or if it has become displaced on the door, you should have it replaced.*

#### To clean the inside of the door:

- Because the area inside the gasket is cleaned during the self-clean cycle, you do not need to clean this by hand.
- The area outside the gasket and the door liner can be cleaned with a soap-filled or plastic scouring pad, hot water and detergent. Rinse well with a vinegar and water solution.

#### To clean the outside of the door:

- Use soap and water to thoroughly clean the top, sides and front of the oven door. Rinse well. You may also use a glass cleaner to clean the glass on the outside of the door. Do not let water drip into the vent openings.

- If any stain on the door vent trim is persistent, use a soft abrasive cleaner and a sponge-scrubber for best results.
- Spillage of marinades, fruit juices, tomato sauces and basting materials containing acids may cause discoloration and should be wiped up immediately. When surface is cool, clean and rinse.
- Do not use oven cleaners, cleaning powders or harsh abrasives on the outside of the door.

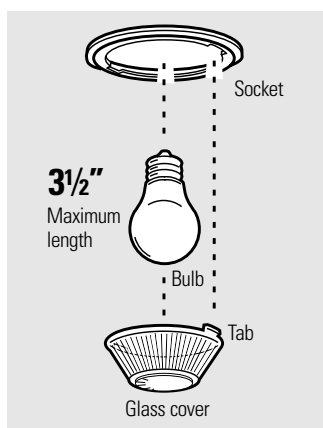

### Lower Oven Light Bulb (on some models)

**NOTE:** The glass cover (on some models) should be removed only when cold. Wearing latex gloves may offer a better grip.

Before replacing the bulb, disconnect electrical power to the oven at the main fuse or circuit breaker panel. Let the bulb cool completely before removing it. For your safety, do not touch a hot bulb with a damp cloth. If you do, the bulb will break.

#### To remove:

Turn the glass cover counterclockwise 1/4 turn until the tabs of the glass cover clear the grooves of the socket. Remove the bulb.

#### To replace:

Put in a new 40-watt appliance bulb. Place the tabs of the glass cover into the grooves of the socket. Turn the glass cover clockwise 1/4 turn.

#### NOTE:

- A 40-watt appliance bulb is smaller than a standard 40-watt household bulb.
- Install and tighten the cover clockwise.
- Reconnect electrical power to the oven.
- For improved lighting inside the oven, clean the glass cover frequently using a wet cloth. This should be done when the oven is completely cool.

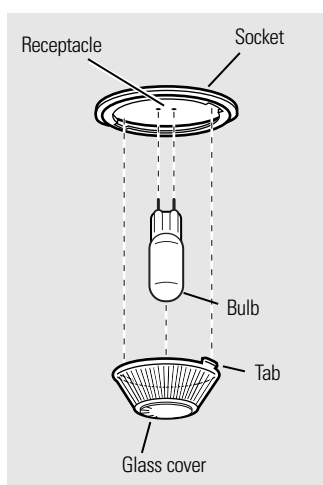

### Lower Oven Light Bulb (on some models)

**NOTE:** The glass cover (on some models) should be removed only when cold. Wearing latex gloves may offer a better grip.

**CAUTION:** Before replacing your oven light bulb, disconnect the electrical power to the oven at the main fuse or circuit breaker panel.

Be sure to let the light cover and bulb cool completely.

For your safety, do not touch a hot bulb with bare hands or a damp cloth.

#### To remove:

- 1 Turn the glass cover counterclockwise 1/4 turn until the tabs of the glass cover clear the grooves of the socket.
- 2 Using gloves or a dry cloth, remove the bulb by pulling it straight out.

#### To replace:

- 1 Use a new 130-volt halogen bulb, not to exceed 50 watts.
- 2 Using gloves or a dry cloth, remove the bulb from its packaging. Do not touch the bulb with bare fingers.

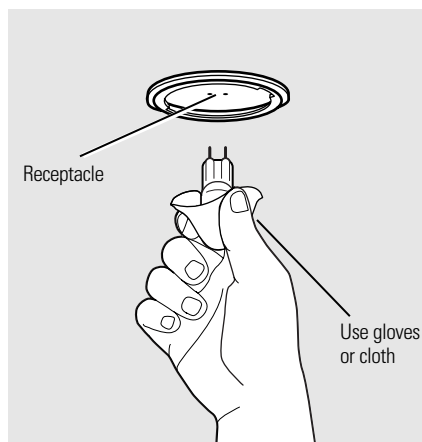

- 3 Push the bulb straight into the receptacle all the way.
- 4 Place the tabs of the glass cover into the grooves of the socket. Turn the glass cover clockwise 1/4 turn.

For improved lighting inside the oven, clean the glass cover frequently using a wet cloth. This should be done when the oven is completely cool.

- 5 Reconnect electrical power to the oven.

## Care and cleaning of the cooking center.

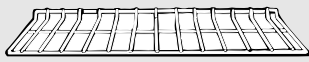

**NOTE:** The oven shelves may be cleaned in the self-cleaning oven. However, the shelves will darken in color, lose their luster and become hard to slide if cleaned during the self-cleaning cycle.

### Oven Shelves (lower oven)

Clean the oven shelves with an abrasive cleanser or steel wool. After cleaning, rinse the shelves and rack with clean water and dry with a clean cloth.

To make the shelves slide more easily, apply a small amount of vegetable oil or cooking oil to a paper towel and wipe the edges of the oven shelves with the paper towel.



### Lower Oven Heating Elements

Do not clean the bake element or the broil element. Any soil will burn off when the elements are heated.

To clean the oven floor, gently lift the bake element. Clean with warm soapy water.

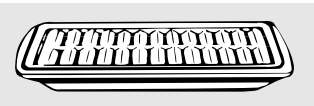

After broiling, remove the broiler pan from the oven.

### Broiler Pan & Grid (lower oven)

Do not clean the broiler pan or grid in a self-cleaning oven.

After broiling, remove the broiler pan from the oven. Remove the grid from the pan. Carefully pour out the grease from the pan into a proper container.

Wash and rinse the broiler pan and grid in hot water with a soap-filled or plastic scouring pad.

If food has burned on, sprinkle the grid with detergent while hot and cover with wet paper towels or a dishcloth. Soaking the pan will remove burned-on foods.

Both the broiler pan and grid may be cleaned with a commercial oven cleaner.

Both the broiler pan and grid can also be cleaned in a dishwasher.

Do not store a soiled broiler pan and grid anywhere in the cooking center.

### Control Panel

It's a good idea to wipe the control panel after each use. Clean with mild soap and water or vinegar and water, rinse with clean water and polish dry with a soft cloth.

Do not use abrasive cleansers, strong liquid cleansers, plastic scouring pads or oven cleaners on the control panel—they will damage the finish. A 50/50 solution of vinegar and hot water works well.

# Before You Call For Service...

ge.com



## Troubleshooting Tips

Save time and money! Review the charts on the following pages first and you may not need to call for service.

Problem	Possible Causes	What To Do
<b>Control panel on microwave oven will not operate</b>	You forgot to press the <b>START</b> pad.	<ul style="list-style-type: none"> <li>Press the <b>START</b> pad.</li> </ul>
	Door not securely closed.	<ul style="list-style-type: none"> <li>Make sure the microwave oven door is closed.</li> </ul>
	Another function was pressed.	<ul style="list-style-type: none"> <li>Press the <b>CLEAR/OFF</b> pad twice to cancel it and begin again.</li> </ul>
	The <b>CLEAR/OFF</b> pad was pressed accidentally.	<ul style="list-style-type: none"> <li>Begin again.</li> </ul>
<b>Oven controls improperly set.</b>		<ul style="list-style-type: none"> <li>While using Time Defrost, numbers not entered after pressing the <b>AUTO DEFROST</b> pad.</li> </ul>
<b>"SENSOR ERROR" appears in the microwave oven display</b>	During a sensor function the microwave oven door was opened too soon.	<ul style="list-style-type: none"> <li>The microwave oven door should not be opened before the time begins to count down in the display.</li> </ul>
<b>Microwave oven light does not work</b>	Light bulb is loose or defective.	<ul style="list-style-type: none"> <li>Call for service.</li> </ul>
<b>Foods overcooked or undercooked in the microwave oven</b>	Varying density and amount of foods being cooked.	<ul style="list-style-type: none"> <li>Varying density and amount sometimes require more cooking time.</li> </ul>
	Food not turned or stirred as called for in the recipe.	<ul style="list-style-type: none"> <li>Turn or stir food and begin again.</li> </ul>
	Too many dishes in the oven at the same time.	<ul style="list-style-type: none"> <li>Do not overload your microwave oven.</li> </ul>
	Food not thoroughly defrosted.	<ul style="list-style-type: none"> <li>See the <i>Using the microwave sensor controls</i> section.</li> </ul>
	Improper cookware or coverings being used.	<ul style="list-style-type: none"> <li>See the <i>Microwave safe cookware</i> section of the <i>Important Safety Instructions</i> section.</li> </ul>
	Humidity or moisture in the oven will lessen the Sensor cooking time.	<ul style="list-style-type: none"> <li>Make sure the inside of the oven and the outside of the containers are dry.</li> </ul>
<b>Clock and timer do not work or display goes blank</b>	Food not allowed to stand.	<ul style="list-style-type: none"> <li>Some standing time is recommended for certain vegetables cooked with the Sensor Controls.</li> </ul>
	A fuse in your home may be blown or the circuit breaker tripped.	<ul style="list-style-type: none"> <li>Replace the fuse or reset the circuit breaker.</li> </ul>
	Controls improperly set.	<ul style="list-style-type: none"> <li>See the <i>Using the clock and lower oven timer</i> section for the lower oven clock.</li> <li>See the <i>Display On/Off</i> section for the microwave oven clock.</li> </ul>
<b>The clock is in the black-out mode.</b>		<ul style="list-style-type: none"> <li>See the <i>Special features of your lower oven control</i> section for the lower oven clock.</li> </ul>

Safety Instructions

Operating Instructions

Care and Cleaning

Troubleshooting Tips

Consumer Support

## Before You Call For Service...



### Troubleshooting Tips

Problem	Possible Causes	What To Do
"F— and a number or letter" flash in the lower oven display	You have a function error code.	<ul style="list-style-type: none"> <li>Press the <b>CLEAR/OFF</b> pad. Allow the oven to cool for one hour. Put the oven back into operation.</li> </ul>
	If the function code repeats.	<ul style="list-style-type: none"> <li>Disconnect all power to the cooking center for at least 30 seconds and then reconnect power. If the function error code repeats, call for service.</li> </ul>
Display flashes	Power failure.	<ul style="list-style-type: none"> <li>Reset the lower oven clock.</li> </ul>
Unable to get the lower oven display to show "SF"	Oven control pads were not pressed properly.	<ul style="list-style-type: none"> <li>The <b>BAKE</b> and <b>BROIL HI/LO</b> pads must be pressed at the same time and held for 3 seconds.</li> </ul>
Lower oven temperature too hot or too cold	Oven thermostat needs adjustment.	<ul style="list-style-type: none"> <li>See the <i>Adjust the lower oven thermostat—Do it yourself!</i> section.</li> </ul>
Lower oven will not work	A fuse in your home may be blown or the circuit breaker tripped.	<ul style="list-style-type: none"> <li>Replace the fuse or reset the circuit breaker.</li> </ul>
	Oven controls improperly set.	<ul style="list-style-type: none"> <li>See the <i>Using the lower oven</i> section.</li> </ul>
Lower oven control signals after entering cooking time or delay start	You forgot to enter a bake temperature or cleaning time.	<ul style="list-style-type: none"> <li>Press the <b>BAKE</b> pad and desired temperature or the <b>SELF CLEAN</b> pad and desired clean time.</li> </ul>
Food does not bake or roast properly in the lower oven	Oven controls improperly set.	<ul style="list-style-type: none"> <li>See the <i>Using the lower oven</i> section.</li> </ul>
	Shelf position is incorrect or the shelf is not level.	<ul style="list-style-type: none"> <li>See the <i>Using the lower oven</i> section.</li> </ul>
	Incorrect cookware or cookware of improper size being used.	<ul style="list-style-type: none"> <li>See the <i>Using the lower oven</i> section.</li> </ul>
	Oven thermostat needs adjustment.	<ul style="list-style-type: none"> <li>See the <i>Adjust the lower oven thermostat—Do it yourself!</i> section.</li> </ul>
Food does not broil properly in the lower oven	Oven controls improperly set.	<ul style="list-style-type: none"> <li>Make sure you press the <b>BROIL HI/LO</b> pad.</li> </ul>
	Improper shelf position being used.	<ul style="list-style-type: none"> <li>See the <i>Broiling Guide</i>.</li> </ul>
	Cookware not suited for broiling.	<ul style="list-style-type: none"> <li>Use the broiling pan and grid that came with your oven.</li> </ul>
	Aluminum foil used on the broiling pan and grid has not been fitted properly and slit as recommended.	<ul style="list-style-type: none"> <li>See the <i>Using the lower oven</i> section.</li> </ul>
	In some areas the power (voltage) may be low.	<ul style="list-style-type: none"> <li>Preheat the broil element for 10 minutes.</li> <li>Broil for the longest period of time recommended in the <i>Broiling Guide</i>.</li> </ul>

<b>Problem</b>	<b>Possible Causes</b>	<b>What To Do</b>
<b>Lower oven light does not work</b>	Light bulb is loose or defective. Pad operating light is broken.	<ul style="list-style-type: none"> <li>• Tighten or replace the bulb.</li> <li>• Call for service.</li> </ul>
<b>Lower oven will not self-clean</b>	Oven controls improperly set. The oven temperature is too high to set a self-clean operation.	<ul style="list-style-type: none"> <li>• See the <i>Using the self-cleaning lower oven</i> section.</li> <li>• Allow the oven to cool and reset the controls.</li> </ul>
<b>"Crackling" or "popping" sound in the lower oven</b>	This is the sound of the metal heating and cooling during both the cooking and cleaning functions.	<ul style="list-style-type: none"> <li>• This is normal.</li> </ul>
<b>Excessive smoking in the lower oven during a clean cycle</b>	Excessive soil.	<ul style="list-style-type: none"> <li>• Press the <b>CLEAR/OFF</b> pad. Open the windows to rid the room of smoke. Wait until the <b>LOCKED</b> or <b>LOCKED DOOR</b> light goes off. Wipe up the excess soil and reset the clean cycle.</li> </ul>
<b>Lower oven door will not open after a clean cycle</b>	Oven too hot.	<ul style="list-style-type: none"> <li>• Allow the oven to cool below locking temperature.</li> </ul>
<b>Lower oven not clean after a clean cycle</b>	Oven controls improperly set. Oven was heavily soiled.	<ul style="list-style-type: none"> <li>• See the <i>Using the self-cleaning lower oven</i> section.</li> <li>• Clean up heavy spillovers before starting the clean cycle. Heavily soiled ovens may need to self-clean again or for a longer period of time.</li> </ul>
<b>"LOCKED" or "LOCKED DOOR" flashes in the lower oven display</b>	The self-clean cycle has been selected but the door is not closed.	<ul style="list-style-type: none"> <li>• Close the oven door.</li> </ul>
<b>LOCKED or "LOCKED DOOR" light is on when you want to cook in the lower oven</b>	The oven door is locked because the temperature inside the oven has not dropped below the locking temperature.	<ul style="list-style-type: none"> <li>• Press the <b>CLEAR/OFF</b> pad. Allow the oven to cool.</li> </ul>
<b>Power outage, clock flashes</b>	Power outage or surge.	<ul style="list-style-type: none"> <li>• Reset the clock. If the oven was in use, you must reset it by pressing the <b>CLEAR/OFF</b> pad, setting the clock and resetting any cooking function.</li> </ul>
<b>"Burning" or "oily" odor emitting from oven vent when using the lower oven</b>	This is normal in a new oven and will disappear in time.	<ul style="list-style-type: none"> <li>• To speed the process, set a self-clean cycle for a minimum of 3 hours. See the <i>Using the self-cleaning lower oven</i> section.</li> </ul>
<b>Strong odor in the lower oven</b>	An odor from the insulation around the inside of the oven is normal for the first few times the oven is used.	<ul style="list-style-type: none"> <li>• This is temporary.</li> </ul>
<b>Fan noise when using the lower oven</b>	A cooling fan may automatically turn on.	<ul style="list-style-type: none"> <li>• This is normal. The cooling fan will turn on to cool internal parts. It may run for up to 1-1/2 hours in 30" models and up to 2 hours in 27" models after the oven is turned off.</li> </ul>





## GE Service Protection Plus™

GE, a name recognized worldwide for quality and dependability, offers you Service Protection Plus™—comprehensive protection on all your appliances—**No Matter What Brand!**

**Benefits Include:**

- Backed by GE
- All brands covered
- Unlimited service calls
- All parts and labor costs included
- No out-of-pocket expenses
- No hidden deductibles
- One 800 number to call

***We'll Cover Any Appliance.  
Anywhere. Anytime.\****

You will be completely satisfied with our service protection or you may request your money back on the remaining value of your contract. No questions asked. It's that simple.

Protect your refrigerator, dishwasher, washer and dryer, range, TV, VCR and much more—**any brand!** Plus there's no extra charge for emergency service and low monthly financing is available. Even icemaker coverage and food spoilage protection is offered. You can rest easy, knowing that all your valuable household products are protected against expensive repairs.

Place your confidence in GE and call us in the U.S. toll-free at **800.626.2224** for more information.

\*All brands covered, up to 20 years old, in the continental U.S.



Please place in envelope and mail to:

***General Electric Company***  
**Warranty Registration Department**  
**P.O. Box 32150**  
**Louisville, KY 40232-2150**

# Consumer Product Ownership Registration

Dear Customer:

Thank you for purchasing our product and thank you for placing your confidence in us. We are proud to have you as a customer!

Follow these three steps to protect your new appliance investment:

# 1

Complete and mail your Consumer Product Ownership Registration today. Have the peace of mind of knowing we can contact you in the unlikely event of a safety modification.

# 2

After mailing the registration below, store this document in a safe place. It contains information you will need should you require service. Our service number is 800.GE.CARES (800.432.2737).

# 3

Read your Owner's Manual carefully. It will help you operate your new appliance properly.

Model Number

Serial Number

**Important: If you did not get a registration card with your product, detach and return the form below to ensure that your product is registered, or register online at [ge.com](http://ge.com).**

 Cut here

## Consumer Product Ownership Registration



Model Number

Serial Number

Mr.  Ms.  Mrs.  Miss

First Name

Last Name

Street Address

Apt. #

E-mail Address\*

City

State

Zip Code

Date Placed In Use  
Month

Day

Year

Phone Number --

\* Please provide your e-mail address to receive, via e-mail, discounts, special offers and other important communications from GE Appliances (GEA).

Check here if you do not want to receive communications from GEA's carefully selected partners.

**FAILURE TO COMPLETE AND RETURN THIS CARD DOES NOT DIMINISH YOUR WARRANTY RIGHTS.**

For more information about GEA's privacy and data usage policy, go to [ge.com](http://ge.com) and click on "Privacy Policy" or call 800.626.2224.



GE Consumer & Industrial  
Appliances  
General Electric Company  
Louisville, KY 40225  
[ge.com](http://ge.com)

# GE Built-In Microwave Cooking Center Warranty.



All warranty service provided by our Factory Service Centers, or an authorized Customer Care® technician. To schedule service, on-line, 24 hours a day, visit us at [ge.com](http://ge.com), or call 800.GE.CARES (800.432.2737). Please have serial number and model number available when calling for service.

Staple your receipt here.  
Proof of the original purchase date is needed to obtain service under the warranty.

## For The Period Of: **GE Will Replace:**

**One Year**  
From the date of the original purchase

**Any part** of the microwave cooking center which fails due to a defect in materials or workmanship. During this **limited one-year warranty**, GE will also provide, **free of charge**, all labor and in-home service to replace the defective part.

## What GE Will Not Cover:

- Service trips to your home to teach you how to use the product.
- Improper installation, delivery or maintenance.
- Failure of the product if it is abused, misused, or used for other than the intended purpose or used commercially.
- Replacement of house fuses or resetting of circuit breakers.
- Damage to the product caused by accident, fire, floods or acts of God.
- Incidental or consequential damage caused by possible defects with this appliance.
- Damage caused after delivery.
- Product not accessible to provide required service.

**EXCLUSION OF IMPLIED WARRANTIES**—Your sole and exclusive remedy is product repair as provided in this Limited Warranty. Any implied warranties, including the implied warranties of merchantability or fitness for a particular purpose, are limited to one year or the shortest period allowed by law.

This warranty is extended to the original purchaser and any succeeding owner for products purchased for home use within the USA. If the product is located in an area where service by a GE Authorized Servicer is not available, you may be responsible for a trip charge or you may be required to bring the product to an Authorized GE Service location for service. In Alaska, the warranty excludes the cost of shipping or service calls to your home.

Some states do not allow the exclusion or limitation of incidental or consequential damages. This warranty gives you specific legal rights, and you may also have other rights which vary from state to state. To know what your legal rights are, consult your local or state consumer affairs office or your state's Attorney General.

**Warrantor: General Electric Company, Louisville, KY 40225**

Safety Instructions

Operating Instructions

Care and Cleaning

Troubleshooting Tips

Consumer Support

## Consumer Support.

---



### *GE Appliances Website*

**ge.com**

Have a question or need assistance with your appliance? Try the GE Appliances Website 24 hours a day, any day of the year! For greater convenience and faster service, you can now download Owner's Manuals, order parts, catalogs, or even schedule service on-line. You can also "Ask Our Team of Experts™" your questions, and so much more...



### *Schedule Service*

**ge.com**

Expert GE repair service is only one step away from your door. Get on-line and schedule your service at your convenience 24 hours any day of the year! Or call 800.GE.CARES (800.432.2737) during normal business hours.



### *Real Life Design Studio*

**ge.com**

GE supports the Universal Design concept—products, services and environments that can be used by people of all ages, sizes and capabilities. We recognize the need to design for a wide range of physical and mental abilities and impairments. For details of GE's Universal Design applications, including kitchen design ideas for people with disabilities, check out our Website today. For the hearing impaired, please call 800.TDD.GEAC (800.833.4322).



### *Extended Warranties*

**ge.com**

Purchase a GE extended warranty and learn about special discounts that are available while your warranty is still in effect. You can purchase it on-line anytime, or call 800.626.2224 during normal business hours. GE Consumer Home Services will still be there after your warranty expires.



### *Parts and Accessories*

**ge.com**

Individuals qualified to service their own appliances can have parts or accessories sent directly to their homes (VISA, MasterCard and Discover cards are accepted). Order on-line today, 24 hours every day or by phone at 800.626.2002 during normal business hours.

***Instructions contained in this manual cover procedures to be performed by any user. Other servicing generally should be referred to qualified service personnel. Caution must be exercised, since improper servicing may cause unsafe operation.***

### *Contact Us*

**ge.com**

If you are not satisfied with the service you receive from GE, contact us on our Website with all the details including your phone number, or write to: General Manager, Customer Relations  
GE Appliances, Appliance Park  
Louisville, KY 40225



### *Register Your Appliance*

**ge.com**

Register your new appliance on-line—at your convenience! Timely product registration will allow for enhanced communication and prompt service under the terms of your warranty, should the need arise. You may also mail in the preprinted registration card included in the packing material.

## Free Manuals Download Website

<http://myh66.com>

<http://usermanuals.us>

<http://www.somanuals.com>

<http://www.4manuals.cc>

<http://www.manual-lib.com>

<http://www.404manual.com>

<http://www.luxmanual.com>

<http://aubethermostatmanual.com>

Golf course search by state

<http://golfingnear.com>

Email search by domain

<http://emailbydomain.com>

Auto manuals search

<http://auto.somanuals.com>

TV manuals search

<http://tv.somanuals.com>