



GE Appliances

Electric Slide-In
Ranges



Owner's Manual

*JSP26
JSP34
JSP40*

www.geappliances.com

Part No. 164D3333P104-3 Pub. No. 49-8868-2 10-99 JR

Safety Information

Anti-Tip Device 3
 Safety Precautions 3, 4
 Oven 5
 Surface Cooking Units 6
 Radiant Surface Units 7

Operating Instructions

Using the Surface Units .. 8–10
 Using the Oven 11–21
 Using the Clock and Timer .. 17
 Timed Baking & Roasting ... 18
 Oven Thermostat 19
 Self-Cleaning Oven 20, 21

Care and Cleaning

Control Panel & Knobs 22
 Oven Light 24
 Coil Surface Units 25
 Broiler Pan & Grid 26
 Removable Storage Drawer .. 26
 Anti-Tip Device 27
 Glass Cooktop 28

Troubleshooting Tips

Before You Call
 For Service 29–32

Customer Service

Product Registration 33
 Warranty 35
 Service Telephone
 Numbers Back Cover

Congratulations!
You Are Now Part of the GE Family.

Welcome to the GE family. We're proud of our quality products and we are committed to providing dependable service. You'll see it in this easy-to-use Owner's Manual and you'll hear it in the friendly voices of our customer service department.

Best of all, you'll experience these values each time you use your range. That's important, because your new range will be part of your family for many years. And we hope you will be part of ours for a long time to come.

We thank you for buying GE. We appreciate your purchase, and hope you will continue to rely on us whenever you need quality appliances for your home.

GE & You, A Service Partnership.



IMPORTANT!

Fill out the Consumer Product Registration Card.

Two easy ways to register your appliance!

- Through the internet at www.geappliances.com
- Complete and mail the enclosed Product Registration Card

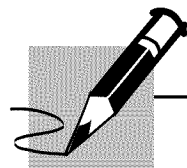

FOR YOUR RECORDS

Write the model and serial numbers here:

 # _____

You can find them on a label on the front of the range behind the storage drawer.

Staple sales slip or cancelled check here.

Proof of the original purchase date is needed to obtain service under the warranty.



READ THIS MANUAL

Inside you will find many helpful hints on how to use and maintain your range properly. Just a little preventive care on your part can save you a great deal of time and money over the life of your range.

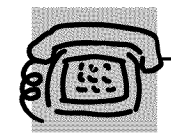

IF YOU NEED SERVICE

You'll find many answers to common problems in the *Before You Call For Service* section. If you review our chart of *Troubleshooting Tips* first, you may not need to call for service at all.

If you do need service, you can relax knowing help is only a phone call away. A list of toll-free customer service numbers is included in the back section of this manual. Or you can always call the GE Answer Center® at 800.626.2000, 24 hours a day, 7 days a week.

IMPORTANT SAFETY INFORMATION. READ ALL INSTRUCTIONS BEFORE USING.

⚠ WARNING!

For your safety, the information in this manual must be followed to minimize the risk of fire, electric shock, or to prevent property damage, personal injury, or loss of life.



⚠ WARNING ANTI-TIP DEVICE

All ranges can tip and injury could result.

To prevent accidental tipping of the range, attach it to the wall and floor by installing the Anti-Tip device supplied.

Check if the device is installed and engaged properly. Make sure the chain fits securely into the slot in the bracket.

If you pull the range out from the wall for any reason, make sure the device is properly engaged when you push the range back against the wall. If it is not, there is a possible risk of the range tipping over and causing injury if you or a child stand, sit or lean on an open door.

Please refer to the Anti-Tip device information in this manual. Failure to take this precaution could result in tipping of the range and injury.



IMPORTANT SAFETY NOTICE

The California Safe Drinking Water and Toxic Enforcement Act requires the Governor of California to publish a list of substances known to the state to cause cancer, birth defects or other reproductive harm, and requires businesses to warn customers of potential exposure to such substances.

The fiberglass insulation in self-clean ovens gives off a very small amount of carbon monoxide during the cleaning cycle. Exposure can be minimized by venting with an open window or using a ventilation fan or hood.

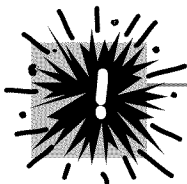

SAFETY PRECAUTIONS

When using electrical appliances, basic safety precautions should be followed, including the following:

- Use this appliance only for its intended purpose as described in this Owner's Manual.
- Be sure your appliance is properly installed and grounded by a qualified installer in accordance with the provided installation instructions.
- Have the installer show you the location of the circuit breaker or fuse. Mark it for easy reference.
- Do not attempt to repair or replace any part of your range unless it is specifically recommended in this manual. All other servicing should be referred to a qualified technician.
- Teach children not to play with the controls or any other part of the range.
- Before performing any service, disconnect the range power supply at the household distribution panel by removing the fuse or switching off the circuit breaker.
- Do not allow anyone to climb, stand or hang on the door, storage drawer or cooktop. They could damage the range and even tip it over, causing severe personal injury.
- Do not store or use combustible materials, gasoline or other flammable vapors and liquids in the vicinity of this or any other appliance.
- Keep the hood and grease filters clean to maintain good venting and to avoid grease fires.

IMPORTANT SAFETY INFORMATION. READ ALL INSTRUCTIONS BEFORE USING.

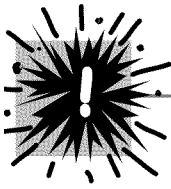

⚠ WARNING! SAFETY PRECAUTIONS

- Do not store flammable materials in an oven or near the cooktop.
 - Do not let cooking grease or other flammable materials accumulate in or near the range.
 - Never leave jars or cans of fat dripping in or near your range.
 - Do not leave children alone—children should not be left alone or unattended in an area where an appliance is in use. They should never be allowed to sit or stand on any part of the appliance.
 - **CAUTION:** Items of interest to children should not be stored in cabinets above a range or on the backsplash (on some models) of a range—children climbing on the range to reach items could be seriously injured.
 - Always keep dish towels, dish cloths, pot holders and other linens a safe distance from your range.
 - Always keep wooden and plastic utensils and canned food a safe distance from your range.
 - Always keep combustible wall coverings, curtains or drapes a safe distance from your range.
 - Never wear loose-fitting or hanging garments while using the appliance. Be careful when reaching for items stored over the range. Flammable material could be ignited if brought in contact with hot surface units or heating elements and may cause severe burns.
 - For your safety, never use your appliance for warming or heating the room.
 - Use only dry pot holders—moist or damp pot holders on hot surfaces may result in burns from steam. Do not let pot holders touch hot surface units or heating elements. Do not use a towel or other bulky cloth in place of potholders.
 - Do not use water on grease fires. Never pick up a flaming pan. Turn the controls off. Smother a flaming pan on a surface unit by covering the pan completely with a well-fitting lid, cookie sheet or flat tray. Use a multi-purpose dry chemical or foam-type fire extinguisher.
- Flaming grease outside a pan can be put out by covering it with baking soda or, if available, by using a multi-purpose dry chemical or foam-type fire extinguisher.
- Flame in the oven can be smothered completely by closing the oven door and turning the oven off or by using a multi-purpose dry chemical or foam-type fire extinguisher.
- Do not touch the surface units, the heating elements or the interior surface of the oven. These surfaces may be hot enough to burn even though they are dark in color. During and after use, do not touch, or let clothing or other flammable materials contact, the surface units, areas nearby the surface units or any interior area of the oven; allow sufficient time for cooling first.
- Potentially hot surfaces include the cooktop, areas facing the cooktop, oven vent opening, surfaces near the opening, crevices around the oven door and metal trim parts above the door.
- REMEMBER:** The inside surface of the oven may be hot when the door is opened.



COOK MEAT AND POULTRY THOROUGHLY...

Cook meat and poultry thoroughly—meat to at least an INTERNAL temperature of 160°F. and poultry to at least an INTERNAL temperature of 180°F. Cooking to these temperatures usually protects against foodborne illness.



OVEN

- Stand away from the range when opening the oven door. Hot air or steam which escapes can cause burns to hands, face and/or eyes.
- Do not heat unopened food containers. Pressure could build up and the container could burst, causing an injury.
- Keep the oven vent unobstructed.
- Keep the oven free from grease buildup.
- Place the oven shelf in the desired position while the oven is cool. If shelves must be handled when hot, do not let pot holder contact the heating elements.
- Pulling out the shelf to the stop-lock is a convenience in lifting heavy foods. It is also a precaution against burns from touching hot surfaces of the door or oven walls.
- When using cooking or roasting bags in the oven, follow the manufacturer's directions.
- Do not use the oven to dry newspapers. If overheated, they can catch on fire.
- Do not use the oven for a storage area. Items stored in an oven can ignite.
- Do not leave paper products, cooking utensils or food in the oven when not in use.
- After broiling, always take the broiler pan out of the range and clean it. Leftover grease in the broiler pan can catch on fire the next time you use the pan.
- Do not use aluminum foil to line oven bottoms, except as suggested in this manual. Improper installation of aluminum foil may result in a risk of electric shock or fire.



SELF-CLEANING OVEN

- Do not clean the door gasket. The door gasket is essential for a good seal. Care should be taken not to rub, damage or move the gasket.
- Clean only parts listed in this Owner's Manual.
- Do not use oven cleaners. No commercial oven cleaner or oven liner protective coating of any kind should be used in or around any part of the oven. Residue from oven cleaners will damage the inside of the oven when the self-clean cycle is used.
- Before self-cleaning the oven, remove the broiler pan, grid and other cookware.
- Be sure to wipe up excess spillage before starting the self-cleaning operation.
- If the self-cleaning mode malfunctions, turn the oven off and disconnect the power supply. Have it serviced by a qualified technician.

IMPORTANT SAFETY INFORMATION. READ ALL INSTRUCTIONS BEFORE USING.

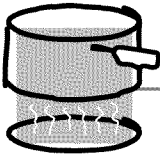

⚠ WARNING! SURFACE COOKING UNITS

Use proper pan size—select cookware having flat bottoms large enough to cover the surface unit heating element. The use of undersized cookware will expose a portion of the surface unit to direct contact and may result in ignition of clothing. Proper relationship of cookware to surface unit will also improve efficiency.

- Never leave the surface units unattended at high heat settings. Boilovers cause smoking and greasy spillovers that may catch on fire.
- Do not use aluminum foil to line the drip pans or anywhere in the oven except as described in this manual. Misuse could result in a shock, fire hazard or damage to the range.
- Be sure the drip pans and the vent duct are not covered and are in place. Their absence during cooking could damage range parts and wiring.
- Only certain types of glass, glass/ceramic, earthenware or other glazed containers are suitable for cooktop service; others may break because of the sudden change in temperature.
- To minimize the possibility of burns, ignition of flammable materials and spillage, the handle of a container should be turned toward the center of the range without extending over nearby surface units.
- Always turn the surface units off before removing cookware.
- Do not immerse or soak the removable surface units. Do not put them in a dishwasher. Do not self-clean the surface units in the oven.
- When flaming foods under the hood, turn the fan on.
- To avoid the possibility of a burn or electric shock, always be certain that the controls for all surface units are at the **OFF** position and all coils are cool before attempting to lift or remove a unit.
- Clean the cooktop with caution. If a wet sponge is used to wipe spills on a hot cooktop, be careful to avoid steam burns.
- Keep an eye on foods being fried at high or medium high heat settings.
- Foods for frying should be as dry as possible. Frost on frozen foods or moisture on fresh foods can cause hot fat to bubble up and over the sides of the pan.
- Use little fat for effective shallow or deep fat frying. Filling the pan too full of fat can cause spillovers when food is added.
- If a combination of oils or fats will be used in frying, stir together before heating, or as fats melt slowly.
- Always heat fat slowly, and watch as it heats.
- Use a deep fat thermometer whenever possible to prevent overheating fat beyond the smoking point.
- Carefully watch for spillovers or overheating of foods when frying at high or medium high temperatures.
- Never try to move a pan of hot fat, especially a deep fat fryer. Wait until the fat is cool.
- Do not allow water, other liquids or grease to remain on the cooktop or the control panel.



RADIANT SURFACE UNITS

Use care when touching the cooktop. The glass surface of the cooktop will retain heat after the controls have been turned off.

- Avoid scratching the glass cooktop. The cooktop can be scratched with items such as sharp instruments, rings or other jewelry and rivets on clothing.
 - Do not operate the radiant surface units if the glass is broken. Spillovers or cleaning solution may penetrate a broken cooktop and create a risk of electrical shock. Contact a qualified technician immediately should your glass cooktop become broken.
 - Never use the glass cooktop surface as a cutting board.
 - Do not place or store items that can melt or catch fire on the glass cooktop, even when it is not being used.
 - Be careful when placing spoons or other stirring utensils on glass cooktop surface when it is in use. They may become hot and could cause burns.
 - Do not stand on the glass cooktop. The weight may cause the top to break.
 - Avoid heating an empty pan. Doing so may damage the cooktop and the pan.
 - Clean the cooktop with caution. If a wet sponge or cloth is used to wipe spills on a hot surface unit, be careful to avoid steam burns. Some cleaners can produce noxious fumes if applied to a hot surface.
- NOTE:** We recommend that you avoid wiping any surface unit areas until they have cooled and the indicator light has gone off. Sugar spills are the exception to this. Please see the *Cleaning the glass cooktop* section.
- When the cooktop is cool, use only the recommended cleaning cream to clean the cooktop.
 - To avoid possible damage to the cooking surface, do not apply cleaning cream to the glass surface when it is hot.
 - After cleaning, use a dry cloth or paper towel to remove all cleaning cream residue.
 - Read and follow all instructions and warnings on the cleaning cream labels.



Read and follow this Safety Information carefully.

SAVE THESE INSTRUCTIONS

Using the surface units.

Throughout this manual, features and appearance may vary from your model.

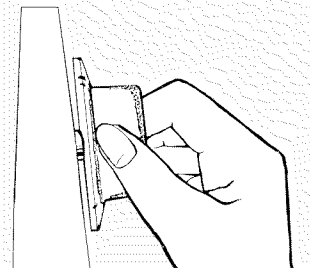

Be sure you turn the control knob to OFF when you finish cooking.

How to Set

Push the knob in and turn in either direction to the setting you want.

At both **OFF** and **HI** the control **clicks** into position. You may hear slight **clicking** sounds during cooking, indicating the control is keeping the power level you set.

A surface unit **ON** indicator light will glow when **any** surface unit is on.

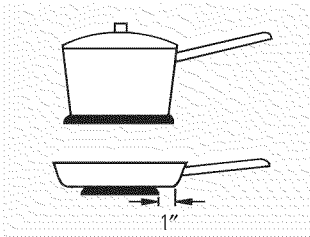

Not over 1 inch.

Surface Cookware Tips (electric coil models only)

Use medium- or heavy-weight cookware. Aluminum cookware conducts heat faster than other metals. Cast-iron and coated cast-iron cookware are slow to absorb heat, but generally cook evenly at low to medium heat settings. Steel pans may cook unevenly if not combined with other metals.

For best cooking results, pans should be flat on the bottom. Match the size of the saucepan to the size of the surface unit. The pan should not extend over the edge of the surface unit more than 1 inch.

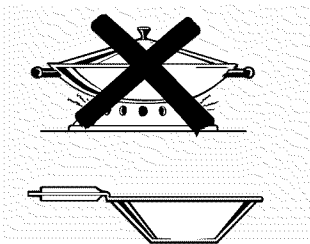

Use only flat-bottomed woks.

Wok Cooking (electric coil models only)

We recommend that you use only a flat-bottomed wok. They are available at your local retail store.

Do not use woks that have support rings. Use of these types of woks, with or without the ring in place, can be dangerous.

Placing the ring over the surface unit will cause a build-up of heat that will damage the porcelain cooktop. Do not try to use such woks without the ring. You could be seriously burned if the wok tipped over.

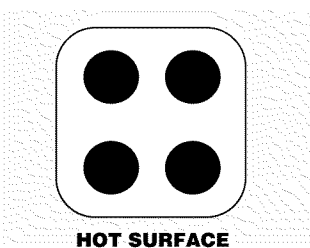

Indicator Lights (glass cooktops only)

A **HOT SURFACE** indicator light will glow when any radiant element is turned on, and will remain on until the surface is cool enough to touch.

- It comes on when the unit is hot to the touch.
- It stays on even after the unit is turned off.
- It glows brightly until the unit is safe to touch.

Deep Fat Frying

Do not overfill cookware with fat that may spill over when adding food. Frosty foods bubble vigorously.

Watch food frying at high temperatures. Keep range and hood clean from grease.



Never cook directly on the glass.
Always use cookware.



Always place the pan in the center of
the surface unit you are cooking on.

About the radiant surface units... (glass cooktops only)

The radiant cooktop features heating units beneath a smooth glass surface.

NOTE: A slight odor is normal when a new cooktop is used for the first time. It is caused by the heating of new parts and insulating materials and will disappear in a short time.

The surface unit will cycle on and off to maintain your selected control setting.

It is safe to place hot cookware on the glass surface even when the cooktop is cool.

Even after the surface units are turned off, the glass cooktop retains enough heat to continue cooking. To avoid overcooking, remove pans from the surface units when the food is cooked. Avoid placing anything on the surface unit until it has cooled completely.

- Before you use the cooktop for the first time, clean it with cleaning cream. This helps protect the top and makes clean-up easier.
- Water stains (mineral deposits) are removable using the cleaning cream or full strength white vinegar.
- Use of window cleaner may leave an iridescent film on the cooktop. The cleaning cream will remove this discoloration.
- Don't store heavy items above the cooktop. If they drop onto the cooktop, they can cause damage.
- Do not use the surface as a cutting board.



Do not slide cookware across the cooktop because it can scratch the glass—the glass is scratch resistant, not scratch proof.

Temperature Limiter (glass cooktops only)

Every radiant surface unit has a temperature limiter.

The temperature limiter protects the glass cooktop from getting too hot.

The temperature limiter may cycle the units off for a time if:

- The pan boils dry.
- The pan bottom is not flat.
- The pan is off center.
- There is no pan on the unit.

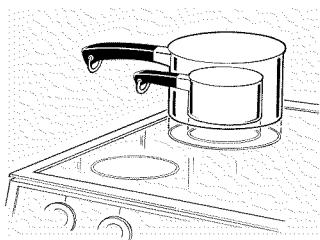

Dual Surface Unit Switch (glass cooktops only)

The left rear surface unit has two cooking sizes to select from so you can match the size of the unit to the size of the cookware you are using.

To use the large (9-inch) surface unit, push in the top portion of the **COIL SIZE** switch next to the control knob. Push in and turn the control knob to the desired setting.

To use the small (6-inch) surface unit, push in the bottom portion of the **COIL SIZE** switch. Push in and turn the control knob to the desired setting.

Selecting types of cookware. *(glass cooktops only)*

The following information will help you choose cookware which will give good performance on glass cooktops.

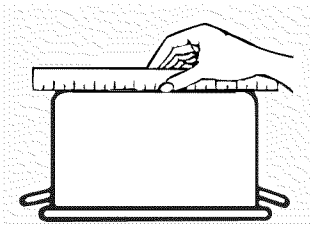

Check pans for flat bottoms by using a straight edge.

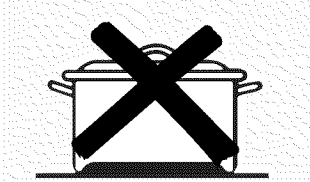
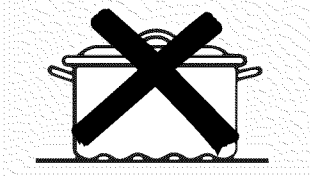
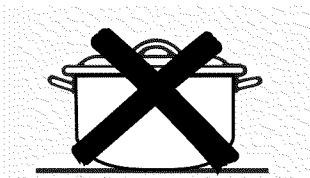

Pans with rounded, curved, ridged or warped bottoms are not recommended.

Stainless Steel:

recommended

Aluminum:

heavy weight recommended

Good conductivity. Aluminum residues sometimes appear as scratches on the cooktop, but can be removed if cleaned immediately. Because of its low melting point, thin weight aluminum should not be used.

Copper Bottom:

recommended

Copper may leave residues which can appear as scratches. The residues can be removed, as long as the cooktop is cleaned immediately. However, do not let these pots boil dry. Overheated metal can bond to glass cooktops. An overheated copper bottom pot will leave a residue that will permanently stain the cooktop if not removed immediately.

Porcelain Enamel Covered Cast Iron:

recommended

As long as the cookware is covered completely with porcelain enamel, this cookware is recommended. Caution is recommended for cast iron cookware that is not completely covered with smooth porcelain enamel, as it may scratch the glass ceramic cooktop.

Glass-ceramic:

usable, but not recommended

Poor performance. May scratch the surface.

Stoneware:

usable, but not recommended

Poor performance. May scratch the surface.

Home Canning Tips:

Be sure the canner is centered over the surface unit.

Make sure the canner is flat on the bottom.

Use recipes and procedures from reputable sources. These are available from manufacturers such as Ball® and Kerr® and the department of Agriculture Extension Service.

To prevent burns from steam or heat, use caution when canning.

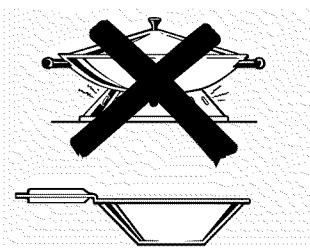

Use only flat-bottomed woks.

Wok Cooking

We recommend that you use only a flat-bottomed wok. They are available at your local retail store.

Do not use woks that have support rings.

Placing the ring over the surface unit will cause a build-up of heat that will damage the cooktop.

Do not use round bottom woks. You could be seriously burned if the wok tipped over.

Using the oven controls.

Throughout this manual, features and appearance may vary from your model.

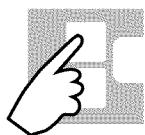
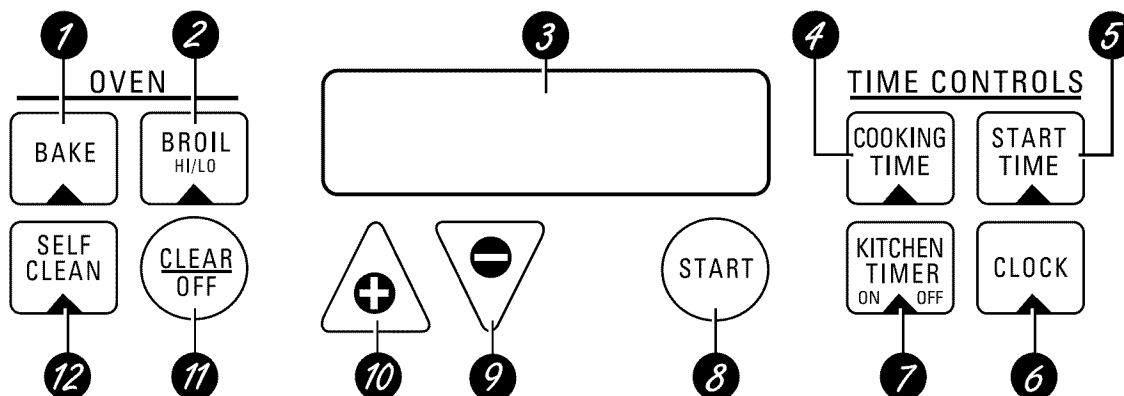

Oven Control, Clock and Timer Features and Settings

- 1 BAKE Pad**
Press this pad to select the bake function.
- 2 BROIL HI/LO Pad**
Press this pad to select the broil function.
- 3 Display**
Shows the time of day and the time set for the timer.
If "F— and a number or letter" flash in the display and the oven control signals, this indicates a function error code.
If your oven was set for a timed oven operation when the power outage occurred, the clock and all programmed functions must be reset.
The time of day will flash in the display when there has been a power outage.
- 4 COOKING TIME Pad**
Press this pad and then press the **INCREASE** or **DECREASE** pads to set the amount of time you want your food to cook. The oven will shut off when the cooking time has run out.
- 5 START TIME Pad**
Press this pad and the **INCREASE** or **DECREASE** pads to delay the starting of your oven up to 9 hours and 59 minutes.
- 6 CLOCK Pad**
Press this pad before setting the clock.
- 7 KITCHEN TIMER ON/OFF Pad**
Press this pad to select the timer feature.
- 8 START Pad**
Must be pressed to start any cooking or cleaning function.
- 9 DECREASE Pad**
Short taps to this pad will decrease the time or temperature by small amounts. Press and hold the pad to decrease the time or temperature by larger amounts.
- 10 INCREASE Pad**
Short taps to this pad will increase the time or temperature by small amounts. Press and hold the pad to increase the time or temperature by larger amounts.
- 11 CLEAR/OFF Pad**
Press this pad to cancel **ALL** oven operations except the clock and timer.
- 12 SELF CLEAN Pad**
Press this pad to select the self-cleaning function. See the *Using the self-cleaning oven* section.

Special features of your oven control.

Your new touch pad control has additional features that you may choose to use. The following are the features and how you may activate them.

The special feature modes can only be activated while the display is showing the time of day. They remain in the control's memory until the steps are repeated.

When the display shows your choice, press the **START** pad. The special features will remain in memory after a power failure.

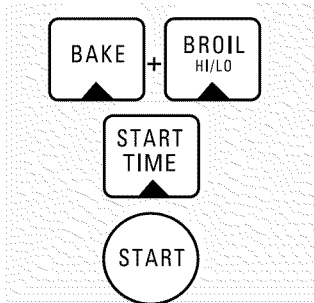

12 Hour Shut-Off

With this feature, should you forget and leave the oven on, the control will automatically turn off the oven after 12 hours during baking functions or after 3 hours during a broil function.

If you wish to turn **OFF** this feature, follow the steps below.

- 1 Press the **BAKE** and **BROIL HI/LO** pads at the same time for 3 seconds until the display shows **SF**.

- 2 Press the **START TIME** pad. The display will show **12 shdn** (12 hour shut-off). Press the **START TIME** pad again and the display will show **no shdn** (no shut-off).

- 3 Press the **START** pad to activate the no shut-off and leave the control set in this special features mode.

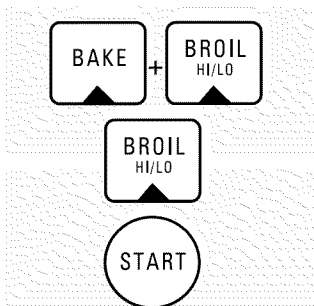

Fahrenheit or Celsius Temperature Selection

Your oven control is set to use the Fahrenheit temperature selections but you may change this to use the Celsius selections.

- 1 Press the **BAKE** and **BROIL HI/LO** pads at the same time for 3 seconds until the display shows **SF**.
- 2 Press the **BROIL HI/LO** pad. The display will show **F** (Fahrenheit).
- 3 Press the **BROIL HI/LO** pad again. The display will show **C** (Celsius).
- 4 Press the **START** pad.

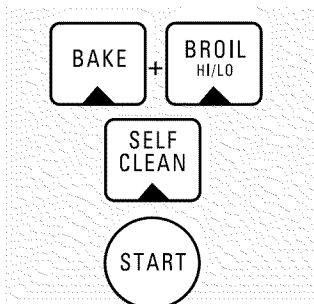

Control Lockout

Your control will allow you to lock out the touch pads so they cannot be activated when pressed.

- 1 Press the **BAKE** and **BROIL HI/LO** pads at the same time for 3 seconds until the display shows **SF**.
- 2 Press the **SELF CLEAN** pad. The display will show **LOC OFF**.
Press the **SELF CLEAN** pad again. The display will show **LOC ON**.
- 3 Press the **START** pad to activate the control lockout feature and leave the control set in this special features mode.

When this feature is on and the touch pads are pressed the control will beep and the display will show **LOC**.

NOTE: The control lockout mode will not affect the **CLOCK** and **KITCHEN TIMER ON/OFF** touch pads.

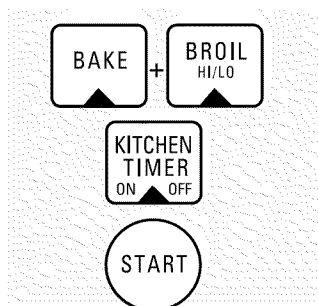

Tones at the End of a Timed Cycle

At the end of a timed cycle, 3 short beeps will sound followed by one beep every 6 seconds until the **CLEAR/OFF** pad is pressed. This continual 6 second beep may be canceled.

To cancel the 6 second beep:

- 1 Press the **BAKE** and **BROIL HI/LO** pads at the same time for 3 seconds until the display shows **SF**.

- 2 Press the **KITCHEN TIMER ON/OFF** pad. The display shows **CON BEEP** (continual beep). Press the **KITCHEN TIMER ON/OFF** pad again. The display shows **BEEP**. (This cancels the one beep every 6 seconds.)

- 3 Press the **START** pad.

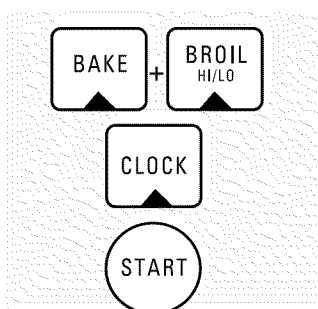

12 Hour, 24 Hour or Clock Black-Out

Your control is set to use a 12 hour clock.

If you would prefer to have a 24 hour military time clock or black-out the clock display, follow the steps below.

- 1 Press the **BAKE** and **BROIL HI/LO** pads at the same time for 3 seconds until the display shows **SF**.

- 2 Press the **CLOCK** pad once. The display will show **12 hr**. If this is the choice you want, press the **START** pad.

Press the **CLOCK** pad again to change to the 24 hour military time clock. The display will show **24 hr**. If this is the choice you want, press the **START** pad.

Press the **CLOCK** pad again to black-out the clock display. The display will show **OFF**. If this is the choice you want, press the **START** pad.

NOTE: If the clock is in the black-out mode you will not be able to use the Delay Start function.

Special features of your oven control.

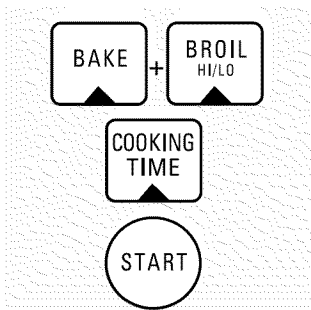

Cook and Hold

Your new control has a cook and hold feature that keeps cooked foods warm for up to 3 hours after the cooking function is finished.

To activate this feature, follow the steps below.

- 1 Press the **BAKE** and **BROIL HI/LO** pads at the same time for 3 seconds until the display shows **SF**.
- 2 Press the **COOKING TIME** pad. The display will show **Hid OFF**.
Press the **COOKING TIME** pad again to activate the feature. The display will show **Hid ON**.
- 3 Press the **START** pad to activate the cook and hold feature and leave the control set in this special features mode.

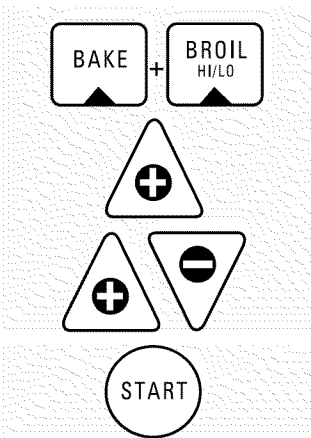

Changing the Speed of the Increase or Decrease Pads

As you use the **INCREASE** or **DECREASE** pads when setting a time or temperature, you may notice the display changes slowly. This special feature allows you to change the speed.

To set the speed you prefer, follow the steps below.

- 1 Press the **BAKE** and **BROIL HI/LO** pads at the same time for 3 seconds until the display shows **SF**.
- 2 Press the **INCREASE** pad. The display will show you a set speed between 1 and 5.
- 3 Press the **INCREASE** pad to increase the speed up to the number 5.
Press the **DECREASE** pad to decrease the speed down to the number 1.
- 4 Press **START** to activate the setting and leave the control set in this special features mode.

Using the oven.

To avoid possible burns, place the shelves in the desired position before you turn the oven on.

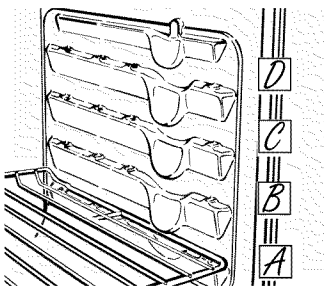

The oven has 4 shelf positions.

Before you begin...

The shelves have stop-locks, so that when placed correctly on the supports, they will stop before coming completely out, and will not tilt.

When placing and removing cookware, pull the shelf out until it stops.

To remove a shelf, pull it toward you, tilt the front end up and pull it out.

To replace, place the end of the shelf (stop-locks) on the support, tilt up the front and push the shelf in.

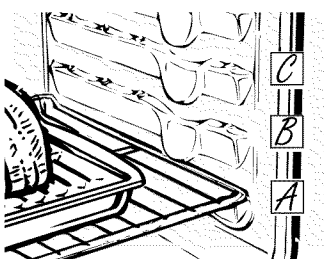

How to Set the Oven for Baking or Roasting

- 1 Press the **BAKE** pad.
- 2 Press the **INCREASE** or **DECREASE** pad to set the oven temperature.

To change the oven temperature during the Bake cycle, press the **BAKE** pad and set the new temperature.

- 3 Press the **START** pad. When the oven starts to heat, the changing temperature will be in the display. The display starts changing once the temperature reaches 100°F.
- 4 Press the **CLEAR/OFF** pad when baking is finished.

Type of Food	Shelf Position
Frozen pies (on cookie sheet)	B or C
Angel food cake, bundt or pound cakes	A
Biscuits, muffins, brownies, cookies, cupcakes, layer cakes, pies	B or C
Casseroles	B or C

NOTE: A cooling fan may automatically turn on and off to cool internal parts. This is normal, and the fan may continue to run even after the oven is turned off.

Preheating and Pan Placement

Preheat the oven if the recipe calls for it. Preheating is necessary for good results when baking cakes, cookies, pastry and breads.

To preheat, set the oven at the correct temperature. The control will beep when the oven is preheated and the display will show your set temperature. This will take approximately 10–15 minutes.

Baking results will be better if baking pans are centered in the oven as much as possible. Pans should not touch each other or the walls of the oven. If you need to use two shelves, stagger the pans so one is not directly above the other, and leave approximately 1½" between pans, from the front, back and sides of the wall.

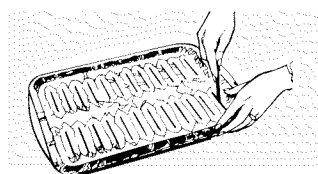

Cut slits in the foil just like the grid.

Aluminum Foil

You can use aluminum foil to line the broiler pan and broiler grid. However, you must mold the foil tightly to the grid and cut slits in it just like the grid.

Without the slits, the foil will prevent fat and meat juices from draining into the broiler pan. The juices could become hot enough to catch on fire. If you do not cut the slits, you are essentially frying, not broiling.

Do not use aluminum foil on the bottom of the oven.

Never entirely cover a shelf with aluminum foil. This will disturb the heat circulation and result in poor baking.

A smaller sheet of foil may be used to catch a spillover by placing it on a lower shelf several inches below the food.

Using the oven.

To avoid possible burns, place the shelves in the desired position before you turn the oven on.

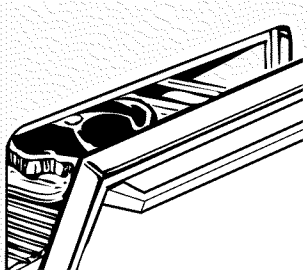

Leave the door open to the broil stop position. The door stays open by itself, yet the proper temperature is maintained in the oven.

How to Set the Oven for Broiling

- 1 Place the meat or fish on the broiler grid in the broiler pan.
- 2 Follow suggested shelf positions in the *Broiling Guide*.
- 3 Press the **BROIL HI/LO** pad once for **HI Broil**.
To change to **LO Broil**, press the **BROIL HI/LO** pad again.
- 4 Press the **START** pad.
- 5 When broiling is finished, press the **CLEAR/OFF** pad.

If your oven is connected to 208 volts, rare steaks may be broiled by preheating the broiler and positioning the oven shelf one position higher.

Use **LO Broil** to cook foods such as poultry or thick cuts of meat thoroughly without over-browning them.

Broiling Guide

Food	Quantity and/or Thickness	Shelf Position	First Side Time (min.)	Second Side Time (min.)	Comments
Bacon	1/2 lb. (about 8 thin slices)	C	4½	4½	Arrange in single layer.
Ground Beef Well Done	1 lb. (4 patties) 1/2 to 3/4" thick	C	10	7	Space evenly. Up to 8 patties take about the same time.
Beef Steaks Rare Medium Well Done	1" thick 1 to 1½ lbs.	C C C	6 8 12	5 6 11	Steaks less than 1" thick cook through before browning. Pan frying is recommended. Slash fat.
Rare Medium Well Done	1½" thick 2 to 2½ lbs.	C C C	10 15 25	7-8 14-16 20-25	
Chicken	1 whole 2 to 2½ lbs., split lengthwise	A	35	10-15	Reduce time about 5 to 10 minutes per side for cut-up chicken. Brush each side with melted butter. Broil skin-side-down first.
Lobster Tails	2-4 6 to 8 oz. each	B	13-16	Do not turn over.	Cut through back of shell. Spread open. Brush with melted butter before broiling and after half of broiling time.
Fish Fillets	1/4 to 1/2" thick	C	5	5	Handle and turn very carefully. Brush with lemon butter before and during cooking, if desired. Preheat broiler to increase browning.
Ham Slices (precooked)	1" thick	B	8	8	Increase time 5 to 10 minutes per side for 1½" thick or home-cured ham.
Pork Chops Well Done	2 (1/2" thick) 2 (1" thick) about 1 lb.	C B	10 13	10 13	Slash fat.
Lamb Chops Medium Well Done	2 (1" thick) about 10 to 12 oz.	C C	10 12	9 10	Slash fat.
Medium Well Done	2 (1½" thick) about 1 lb.	C B	14 17	12 12-14	

Using the clock and timer.



Make sure the clock is set to the correct time of day.

To Set the Clock

The clock must be set to the correct time of day for the automatic oven timing functions to work properly. The time of day cannot be changed during a timed baking or self-cleaning cycle.

- 1 Press the **CLOCK** pad.
- 2 Press the **INCREASE** or **DECREASE** pads.
- 3 Press the **START** pad.



The timer is a minute timer only. The timer does not control oven operations. The maximum setting on the timer is 9 hours and 59 minutes.

To Set the Timer

- 1 Press the **KITCHEN TIMER ON/OFF** pad.
- 2 Press the **INCREASE** or **DECREASE** pads until the amount of time you want shows in the display.

If you make a mistake press the **KITCHEN TIMER ON/OFF** pad and begin again.

- 3 Press the **START** pad.
- 4 When the timer reaches :00, the control will beep 3 times followed by one beep every 6 seconds until the **KITCHEN TIMER ON/OFF** pad is pressed.

The 6 second tone can be canceled by following the steps in the Special features of your oven control section under Tones at the End of a Timed Cycle.

To Reset the Timer

If the display is still showing the time remaining, you may change it by pressing the **KITCHEN TIMER ON/OFF** pad, then press the **INCREASE** or **DECREASE** pads until the time you want appears in the display.

If the remaining time is not in the display (clock, delay start or cooking time are in the display), recall the remaining time by pressing the **KITCHEN TIMER ON/OFF** pad and then pressing the **INCREASE** or **DECREASE** pads to enter the new time you want.

To Cancel the Timer

Press the **KITCHEN TIMER ON/OFF** pad twice.

Using the timed baking and roasting features.

NOTE: Foods that spoil easily—such as milk, eggs, fish, stuffings, poultry and pork—should not be allowed to sit for more than 1 hour before or after cooking. Room temperature promotes the growth of harmful bacteria. Be sure that the oven light is off because heat from the bulb will speed harmful bacteria growth.

The low temperature zone of this range (between 170°F. and 200°F.) is available to keep hot cooked foods warm. Food kept in the oven longer than 2 hours at these low temperatures may spoil.

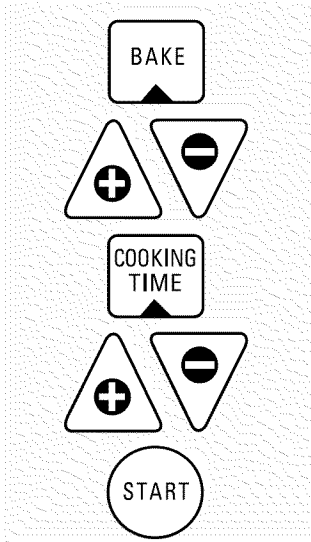

How to Set an Immediate Start and Automatic Stop

The oven will turn on immediately and cook for a selected length of time. At the end of the cooking time the oven will turn off automatically.

- 1 Press the **BAKE** pad.
- 2 Using the **INCREASE** or **DECREASE** pads, enter the desired temperature.
- 3 Press the **COOKING TIME** pad.

NOTE: If your recipe requires preheating, you may need to add additional time to the length of the cooking time.

- 4 Using the **INCREASE** or **DECREASE** pads, enter the desired baking time. The oven temperature and the cooking time that you entered will be displayed.
- 5 Press the **START** pad.

The display shows the oven temperature that you set and the cooking time countdown. The display starts changing once the temperature reaches 100°F.

The oven will continue to cook for the programmed amount of time, then shut off automatically.

Press the **CLEAR/OFF** pad to clear the display.

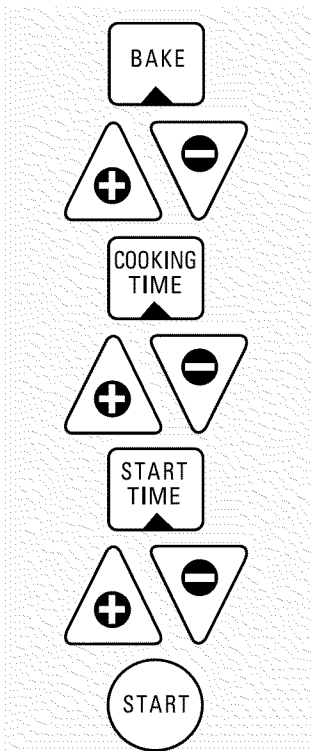

How to Set a Delayed Start and Automatic Stop

You can set the oven control to delay-start the oven, cook for a specific length of time and then turn off automatically.

Make sure the clock shows the correct time of day.

- 1 Press the **BAKE** pad.
- 2 Using the **INCREASE** or **DECREASE** pads, enter the desired temperature.
- 3 Press the **COOKING TIME** pad.

NOTE: If your recipe requires preheating, you may need to add additional time to the length of the cooking time.

- 4 Using the **INCREASE** or **DECREASE** pads, enter the desired baking time.
- 5 Press the **START TIME** pad.
- 6 Using the **INCREASE** or **DECREASE** pads, enter the time of day you want the oven to turn on and start cooking.

- 7 Press the **START** pad.

NOTE: An attention tone will sound if you are using timed baking and do not press the **START** pad after entering the baking temperature.

If you would like to check the times you have set, press the **START TIME** pad to check the start time you have set or press the **COOKING TIME** pad to check the length of cooking time you have set.

When the oven turns on at the time of day you have set, the display will show the changing temperature (starting at 100°F.) and the cooking time countdown.

At the end of timed baking, the oven will turn off. The end of cycle tone will sound.

Press the **CLEAR/OFF** pad to clear the display.

Adjust the oven thermostat—Do it yourself!

You may find that your new oven cooks differently than the one it replaced. Use your new oven for a few weeks to become more familiar with it. If you still think your new oven is too hot or too cold, you can adjust the thermostat yourself.

Do not use thermometers, such as those found in grocery stores, to check the temperature setting of your oven. These thermometers may vary 20–40 degrees.

NOTE: This adjustment will not affect the broiling or the self-cleaning temperatures. The adjustment will be retained in memory after a power failure.

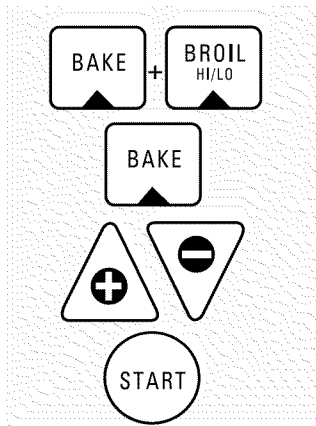

To Adjust the Thermostat

- 1 Press the **BAKE** and **BROIL HI/LO** pads at the same time for 3 seconds until the display shows **SF**.
- 2 Press the **BAKE** pad. A two digit number shows in the display.
- 3 The oven temperature can be adjusted up to (+) 35°F. hotter or (-) 35°F. cooler.

Press the **INCREASE** pad to increase the temperature in 1 degree increments.

Press the **DECREASE** pad to decrease the temperature in 1 degree increments.
- 4 When you have made the adjustment, press the **START** pad to go back to the time of day display. Use your oven as you would normally.

The type of margarine will affect baking performance!

Most recipes for baking have been developed using high fat products such as butter or margarine (80% fat). If you decrease the fat, the recipe may not give the same results as with a higher fat product.

Recipe failure can result if cakes, pies, pastries, cookies or candies are made with low fat spreads. The lower the fat content of a spread product, the more noticeable these differences become.

Federal standards require products labeled “margarine” to contain at least 80% fat by weight. Low fat spreads, on the other hand, contain less fat and more water. The high moisture content of these spreads affects the texture and flavor of baked goods. For best results with your old favorite recipes, use margarine, butter or stick spreads containing at least 70% vegetable oil.

Using the self-cleaning oven.

The oven door must be closed and all controls must be set correctly for the cycle to work properly.

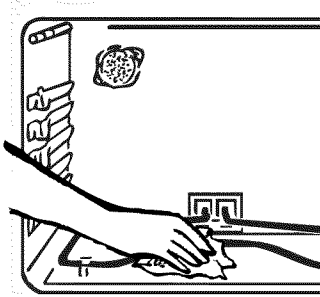

Wipe up heavy soil on the oven bottom. (appearance may vary)

Before a Clean Cycle

We recommend venting your kitchen with an open window or using a ventilation fan or hood during the first self-clean cycle.

Remove the shelves, broiler pan, broiler grid, all cookware and any aluminum foil from the oven.

The oven shelves can be self-cleaned, but they will darken, lose their luster and become hard to slide.

Soil on the front frame of the range and outside the gasket on the door will need to be cleaned by hand. Clean these areas with hot water, soap-filled steel-wool pads or cleansers such as Soft Scrub®. Rinse well with clean water and dry.

Do not clean the gasket. The fiberglass material of the oven door gasket cannot withstand abrasion. It is essential for the gasket to remain intact. If you notice it becoming worn or frayed, replace it.

Wipe up any heavy spillovers on the oven bottom.

Make sure the oven light bulb cover is in place and the oven light is off.

IMPORTANT: The health of some birds is extremely sensitive to the fumes given off during the self-cleaning cycle of any range. Move birds to another well ventilated room.

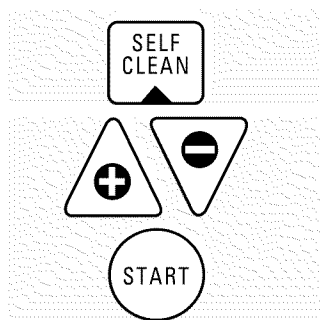

How to Set the Oven for Cleaning

- 1 Press the **SELF CLEAN** pad.
- 2 Using the **INCREASE** or **DECREASE** pads, enter the desired clean time, if a time other than 4 hours is needed.

Clean cycle time is normally 4 hours. You can change the clean time to any time between 3 hours and 5 hours, depending on how dirty your oven is.

- 3 Press the **START** pad.

The door locks automatically. The display will show the clean time remaining. It will not be possible to open the oven door until the temperature drops below the lock temperature and the **LOCKED DOOR** light goes off.

The oven shuts off automatically when the clean cycle is complete.

When the **LOCKED DOOR** light is off, open the door.

■ The words **LOCK DOOR** will flash and the oven control will signal if you set the clean cycle and forget to close the oven door.

■ To stop a clean cycle, press the **CLEAR/OFF** pad. When the **LOCKED DOOR** light goes off indicating the oven has cooled below the locking temperature, open the door.

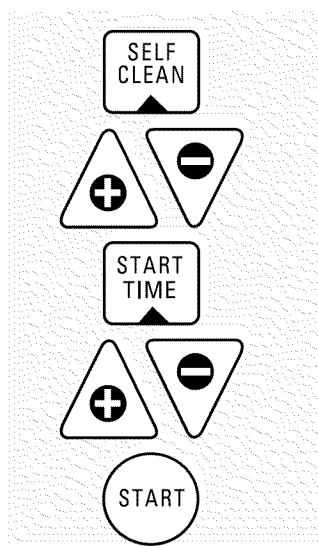

How to Delay the Start of Cleaning

Make sure the clock shows the correct time of day.

- 1 Press the **SELF CLEAN** pad.
- 2 Using the **INCREASE** or **DECREASE** pads, enter the desired clean time.
- 3 Press the **START TIME** pad. The earliest start time you can set will appear in the display.
- 4 Using the **INCREASE** or **DECREASE** pads, enter the time of day you want the clean cycle to start.
- 5 Press the **START** pad.

The door locks automatically. The display will show the start time. It will not be possible to open the oven door until the temperature drops below the lock temperature and the **LOCKED DOOR** light goes off.

The oven shuts off automatically when the clean cycle is complete.

When the **LOCKED DOOR** light is off, open the door.

After a Clean Cycle

You may notice some white ash in the oven. Wipe it up with a damp cloth after the oven cools.

If white spots remain, remove them with a soap-filled steel wool pad and rinse thoroughly with a vinegar and water mixture.

These deposits are usually a salt residue that cannot be removed by the clean cycle.

If the oven is not clean after one clean cycle, repeat the cycle.

■ You cannot set the oven for cooking until the oven is cool enough for the door to unlock.

■ While the oven is self-cleaning, you can press the **CLOCK** pad to display the time of day. To return to the clean countdown, press the **COOKING TIME** pad.

■ If the shelves become hard to slide, apply a small amount of vegetable oil or cooking oil to a paper towel and wipe the edges of the oven shelves with the paper towel.

Care and cleaning of the range.

Be sure electrical power is off and all surfaces are cool before cleaning any part of the range.

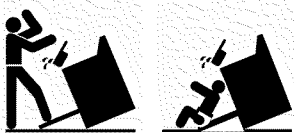

If your range is removed for cleaning, servicing or any reason, be sure the anti-tip device is re-engaged properly when the range is replaced. Failure to take this precaution could result in tipping of the range and cause injury.

How to Remove Packaging Tape

To assure no damage is done to the finish of the product, the safest way to remove the adhesive left from packaging tape on new appliances is an application of a household liquid dishwashing detergent, mineral oil or cooking oil.

Apply with a soft cloth and allow to soak. Wipe dry and then apply an appliance polish to thoroughly clean and protect the surface.

NOTE: The plastic tape must be removed from all chrome trim. It cannot be removed if it is baked on.

Control Panel

It's a good idea to wipe the control panel after each use. Clean with mild soap and water or vinegar and water, rinse with clean water and polish dry with a soft cloth.

Do not use abrasive cleansers, strong liquid cleansers, plastic scouring pads or oven cleansers on the control panel—they will damage the finish. A 50/50 solution of vinegar and hot water works well.

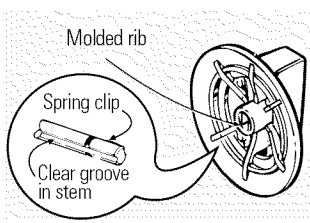

Control Knobs

The control knobs may be removed for easier cleaning.

Before removing the knobs for cleaning, please note that the knobs are in the **OFF** position. When replacing the knobs, check the **OFF** position to insure proper placement.

The knob stem has a groove in each side. The groove on one side has a spring clip.

The other groove is clear (see illustration). Check the inside of the knob and find the molded rib.

Wash the knobs in soap and water or a vinegar and hot water solution but do not soak.

Replace the knob by fitting the molded rib inside the knob into the clear groove on the stem.

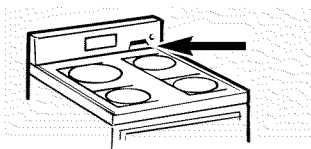

Oven Vent (glass cooktop models only)

On models with glass cooktops, the oven is vented through an opening at the rear of the cooktop.

Never cover the opening with aluminum foil or any other material.

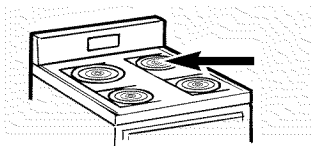

Oven Vent (electric coil models only)

The oven is vented through an opening under the right rear surface unit.

Never cover the opening with aluminum foil or any other material.

Porcelain Enamel Cooktop *(electric coil models only)*

The porcelain enamel finish is sturdy but breakable if misused. This finish is acid-resistant. However, any acidic foods spilled (such as fruit juices, tomato or vinegar) should not be permitted to remain on the finish.

If acids spill on the cooktop while it is hot, use a dry paper towel or cloth to wipe it up right away. When the surface has cooled, wash with soap and water. Rinse well.

For other spills such as fat splatterings, wash with soap and water or cleansing powders after the surface has cooled. Rinse well. Polish with a dry cloth.

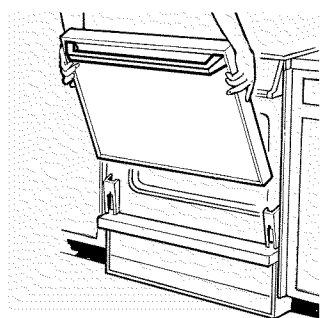

Lift the door straight up and off the hinges.

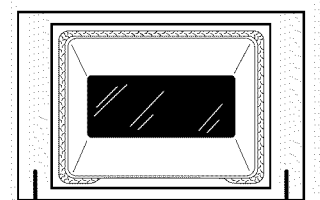

(appearance may vary)

The gasket is designed with a gap at the bottom to allow for proper air circulation.

Do not rub or clean the door gasket—it has an extremely low resistance to abrasion.

If you notice the gasket becoming worn, frayed or damaged in any way or if it has become displaced on the door, you should have it replaced.

Lift-Off Oven Door

The oven door is removable for easier access to the light bulb.

Do not lift the door by the handle.

To remove the door, open it to the broil stop position. Grasp firmly on each side and lift the door straight up and off the hinges.

Do not place hands between the hinge and the oven door frame.

To replace the door, make sure the hinges are in the broil stop position. Position the slots in the bottom of the door squarely over the hinges and slowly lower it over both hinges.

To clean the inside of the door:

- Because the area inside the gasket is cleaned during the self-clean cycle, you do not need to clean this by hand.
- The area outside the gasket and the front frame can be cleaned with a soap-filled steel wool or plastic pad, hot water and detergent. Rinse well with a vinegar and water solution.

To clean the outside of the door:

- Use soap and water to thoroughly clean the top, sides and front of the oven door. Rinse well. You may also use a glass cleaner to clean the glass on the outside of the door. Do not let water drip into the vent openings.
- Spillage of marinades, fruit juices, tomato sauces and basting materials containing acids may cause discoloration and should be wiped up immediately. When surface is cool, clean and rinse.
- Do not use oven cleaners, cleaning powders or harsh abrasives on the outside of the door.

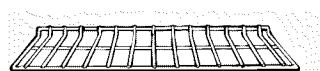

Oven Shelves

Clean the oven shelves with an abrasive cleanser or steel wool. After cleaning, rinse the shelves with clean water and dry with a clean cloth.

NOTE: The oven shelves may be cleaned in the self-cleaning oven. However, the shelves will darken in color, lose their luster and become hard to slide if cleaned during the self-cleaning cycle.

To make the shelves slide more easily apply a small amount of vegetable oil or cooking oil to a paper towel and wipe the edges of the oven shelves with the paper towel.

Care and cleaning of the range.

Painted Surfaces

Painted surfaces include the sides and the drawer front.

Clean these with soap and water or a vinegar and water solution.

Do not use commercial oven cleaners, cleaning powders, steel wool or harsh abrasives on any painted surface.

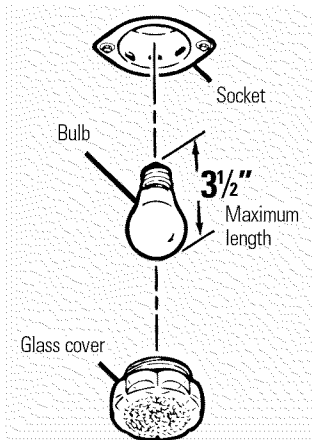

Oven Light Bulb (on some models)

NOTE: The glass cover should be removed only when cold. Wearing latex gloves may offer a better grip.

Before replacing the bulb, disconnect electrical power to the range at the main fuse or circuit breaker panel. Let the bulb cool completely before removing it. For your safety, do not touch a hot bulb with a damp cloth. If you do, the bulb will break.

To remove:

Turn to remove the cover, then remove the bulb.

To replace:

Put in a new 40-watt appliance bulb.

NOTE:

- A 40-watt appliance bulb is smaller than a standard 40-watt household bulb.
- Install and tighten the cover.
- Reconnect electrical power to the range.
- For improved lighting inside the oven, clean the glass cover frequently using a wet cloth. This should be done when the oven is completely cool.

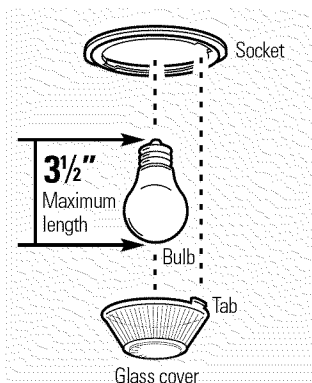

Oven Light Bulb (on some models)

NOTE: The glass cover (on some models) should be removed only when cold. Wearing latex gloves may offer a better grip.

Before replacing the bulb, disconnect electrical power to the range at the main fuse or circuit breaker panel. Let the bulb cool completely before removing it. For your safety, do not touch a hot bulb with a damp cloth. If you do, the bulb will break.

To remove:

Turn the glass cover counterclockwise 1/4 turn until the tabs of the glass cover clears the grooves of the socket. Remove the bulb.

To replace:

Put in a new 40-watt appliance bulb. Place the tabs of the glass cover into the groove of the socket. Turn the glass cover clockwise 1/4 turn.

NOTE:

- A 40-watt appliance bulb is smaller than a standard 40-watt household bulb.
- Reconnect electrical power to the range.
- For improved lighting inside the oven, clean the glass cover frequently using a wet cloth. This should be done when the oven is completely cool.

Be sure the controls are turned to OFF and the surface units are cool before attempting to remove them.

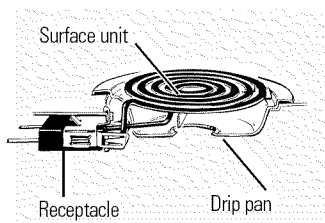

Surface Units (electric coil models only)

To clean the surface units, turn the control to the highest setting for a minute. The coils will burn off any soil.

To remove a surface unit:

To remove the drip pans for cleaning, the surface units must be removed first.

Lift the surface unit about 1 inch above the drip pan and pull it out.

Do not lift the surface unit more than 1 inch. If you do, it may not lie flat on the drip pan when you plug it back in.

Repeated lifting of the surface unit more than 1 inch above the drip pan can permanently damage the receptacle.

To replace a surface unit:

Replace the drip pan into the recess in the cooktop. Make sure the opening in the pan lines up with the receptacle.

Insert the terminals of the surface unit through the opening in the drip pan and into the receptacle.

Guide the surface unit into place so it rests evenly.

Do not immerse the surface units in liquids of any kind.

Do not clean the surface units in a dishwasher.

Do not bend the surface unit plug terminals.

Do not attempt to clean, adjust or in any way repair the plug-in receptacle.

Drip Pans (electric coil models only)

Remove the surface units. Then lift out the drip pans.

For best results, clean the drip pans by hand. Place them in a covered container (or a plastic bag) with 1/4 cup ammonia to loosen the soil. Then scrub with a soap-filled scouring pad if necessary. Rinse with clean water and polish with a clean soft cloth.

The drip pans may also be cleaned in a dishwasher.

Clean the area under the drip pans often. Built-up soil, especially grease, may catch fire.

Do not cover the drip pans with foil. Using foil so close to the receptacle could cause shock, fire or damage to the range.

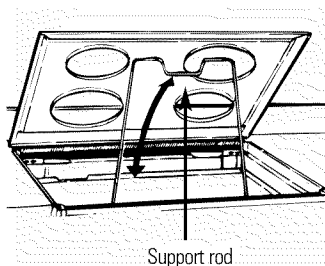

Lift-Up Cooktop (electric coil models only)

Clean the area under the cooktop often. Built-up soil, especially grease, may catch fire.

To make cleaning easier, the entire cooktop may be lifted up and supported in the up position.

Be sure all the surface units are turned off before raising the cooktop. The surface units and drip pans do not need to be removed, however, you may remove one to make raising the cooktop easier.

A support rod will hold the cooktop up while you clean underneath it.

After cleaning under the cooktop with hot, soapy water and a clean cloth, lower the cooktop. Be careful not to pinch your fingers.

Be sure all surface units are turned off before raising the cooktop.

Care and cleaning of the range.

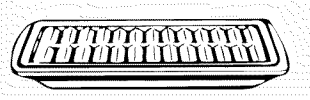

After broiling, remove the broiler pan from the oven.

Broiler Pan & Grid

Do not clean the broiler pan or grid in a self-cleaning oven.

After broiling, remove the broiler pan from the oven. Remove the grid from the pan. Carefully pour out the grease from the pan into a proper container.

Wash and rinse the broiler pan and grid in hot water with a soap-filled or plastic scouring pad.

If food has burned on, sprinkle the grid with detergent while hot and cover with wet paper towels or a dishcloth. Soaking the pan will remove burned-on foods.

Both the broiler pan and grid may be cleaned with a commercial oven cleaner.

Both the broiler pan and grid can also be cleaned in a dishwasher.

Do not store a soiled broiler pan and grid anywhere in the range.

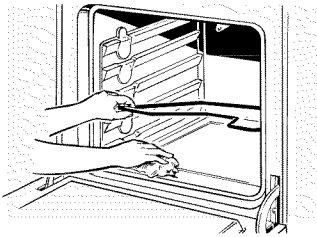

Oven Heating Elements

Do not clean the bake element or the broil element. Any soil will burn off when the elements are heated.

To clean the oven floor, gently lift the bake element. Clean with warm soapy water.

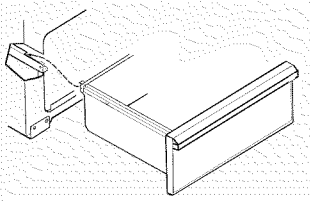

The storage drawer may be removed for cleaning under the range.

Removable Storage Drawer

The storage drawer is a good place to store cookware and bakeware. Do not store plastics and flammable material in the drawer.

Do not overload the storage drawer. If the drawer is too heavy, it may slip off the track when opened. To open the drawer, grasp the center of the handle and pull straight out.

To remove:

Pull the drawer straight out and lift over the guide stops.

To replace:

Lift over the guide stops and slide the drawer into place.

To clean both the inside and the outside: Wipe with soap and water. Rinse well.

Do not use cleansing powders or harsh abrasives which may scratch the surface.

If the range is removed for cleaning or any reason, make sure the chain is reattached.

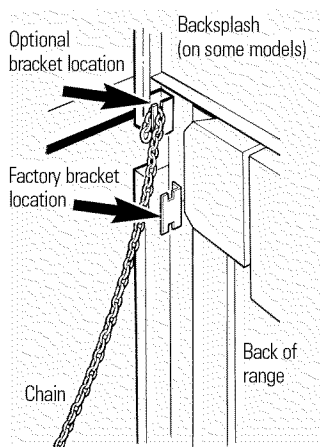

Anti-Tip Device

- Before placing range in the counter, notice the location of the stability bracket which is already attached to the back of the range. This location should work for most installations. However, it may be more convenient to hook the stability chain to the unit when the stability bracket is attached to the upper set of holes in the back of range.

The upper level set of holes is intended for use with a backsplash kit. If the backsplash is not being used, make sure that there are no structural supports for the countertop which will interfere with the stability bracket when located in the upper set of holes.

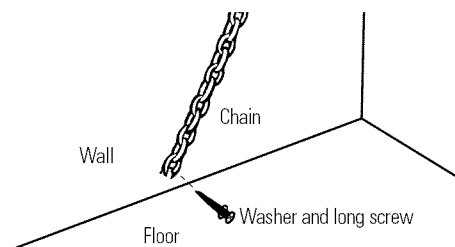

- Fasten one end of the stability chain to the floor or wall with the long screw and washer supplied.

NOTE: If attaching to masonry, you can buy suitable screws and anchors at hardware stores. Use a masonry drill to drill the required holes.

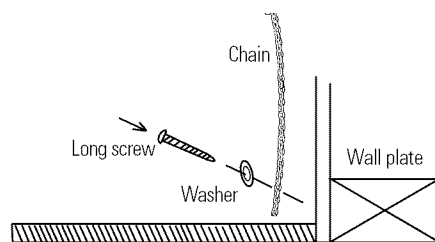

Make certain the screw is going into the wall plate at the base of the wall or one of the studs in the base of the wall.

Whether you attach the chain to the wall or floor, be certain that the screw is in at least 3/4 inch thickness of wood other than baseboard and that there are no electrical wires or plumbing in the area which the screw could penetrate. Attach the stability chain in a location which will allow the chain to be in line with the bracket side to aide as much as possible when attached to the unit. Test to see if the chain is securely fastened by tugging on the chain.

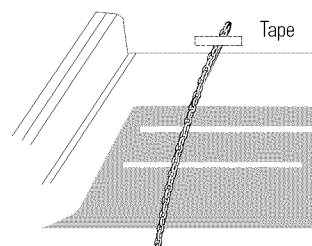

- Temporarily attach the loose end of the chain to the rear of the countertop with the tape from the packaging.
- Place the range in the counter cutout leaving just enough room between the back of the range and the wall to reach the stability bracket.
- Hook the loose end of the chain onto the bracket by slipping the nearest link of the chain into the slot in the bracket. Make sure the chain is pulled as tight as possible and that there is no excess slack in the chain after the chain is attached to the bracket.
- Slide the range all the way back into the counter. Once the range is pushed back in place, there will be a small amount of slack in the chain. This is normal.

CAUTION: Excessive slack in the chain could allow the range to tip over.

Cleaning the glass cooktop. *(on some models)*

Clean the glass surface with cleaning cream before you use the cooktop for the first time. Also, clean the glass surface after each use. This helps protect the top and makes clean-up easier.

To clean the cooktop seal around the edge of the glass, let a wet cloth rest on it for a few minutes, then wipe clean. Use a mild detergent if needed.

Do not use a knife or any sharp object on the seal because it will cut or damage it.

Normal Cleaning

Use only a recommended cleaning cream, such as Cerama Brite or another cooktop cleaning cream, on the glass cooktop.

To maintain and protect the surface of your new glass cooktop follow these steps.

- 1 Before you use the cooktop for the first time, clean it with cleaning cream. This helps protect the top and makes clean-up easier.

- 2 Clean the surface with the cleaning cream after each use.

- 3 Rub a few drops (less is better) of the cleaning cream onto soiled area using a damp paper towel. Buff with a dry paper towel until all soil and cream are removed.

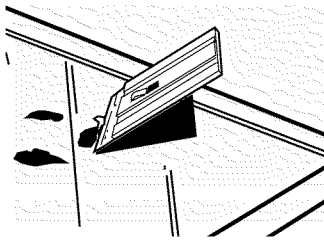

Using a razor scraper will not damage the surface if the 45° angle is maintained.

For Heavy, Burned-On Soil...

- 1 Allow the cooktop to cool.
- 2 Apply a few drops of cleaning cream to the cool, soiled area. Spread the cream across the entire soiled area.
- 3 Hold scraper at a 45° angle against the glass ceramic surface. This 45° angle makes the scraping easier.
- 4 Scrape soil with the enclosed razor scraper. Keep small amount of cream on the soil as you scrape. Heavily soiled areas may require repeated applications of cream. It will be necessary to press down on

the razor scraper while scraping the soiled area with cooktop cream.

Be sure to use a new sharp razor scraper. Do not use a dull or nicked blade.

- 5 If any soil remains, repeat the steps listed above.

To order more cream and/or scrapers for cleaning your glass cooktop, please call our toll-free number:

National Parts Center800-626-2002

Cleaner# WX10X300
Scraper# WX5X1614
Cream & scraper kit# WB64X5027

Our testing shows that if you are cooking high sugar mixtures such as jelly or fudge and have a spillover, permanent damage to the cooktop surface may occur unless the spillover is immediately removed.

Special Care for Sugary Spills

Be sure to use a new sharp razor scraper. Do not use a dull or nicked blade.

Sugary spillovers (such as jellies, fudge, candy syrups) or melted plastics can cause pitting of the surface of your cooktop (not covered by the warranty) unless the spill is removed while still hot. **Special care should be taken when removing hot substances.**

- 1 Turn off all surface units affected by the spillover. Remove hot pans.
- 2 Wearing an oven mitt, hold the razor scraper at a 45° angle to the cooktop. Scrape the hot spill to a cool area outside the surface unit.

- 3 With the spill in a cool area, use a dry paper towel to remove any excess. Any spillover remaining should be left until the surface of the cooktop has cooled. Do not continue to use the soiled surface unit until all of the spillover has been removed. Follow the steps under *Heavy Burned-On Soil* to continue the cleaning process.

NOTE: *If pots with a thin overlay of aluminum, copper or enamel are allowed to boil dry, the overlay may bond with the glass cooktop and leave a black discoloration. This should be removed immediately before heating again or the discoloration may be permanent.*

Before You Call For Service...



Troubleshooting Tips
Save time and money! Review the charts on the following pages first and you may not need to call for service.

Problem	Possible Causes	What To Do
Glass Cooktop Models		
Surface units will not maintain a rolling boil or cooking is not fast enough	Improper cookware being used.	<ul style="list-style-type: none"> Use pans which are flat and match the diameter of the surface unit selected.
Surface units do not work properly	A fuse in your home may be blown or the circuit breaker tripped.	<ul style="list-style-type: none"> Replace fuse or reset circuit breaker.
	Cooktop controls improperly set.	<ul style="list-style-type: none"> Check to see the correct control is set for the surface unit you are using.
Tiny scratches (may appear as cracks) or abrasions on radiant cooktop glass surface	Incorrect cleaning methods being used.	<ul style="list-style-type: none"> Use recommended cleaning procedures.
	Cookware with rough bottoms being used or coarse particles (salt or sand were between the cookware and the surface of the cooktop.	<ul style="list-style-type: none"> Be sure cookware bottoms and cookware are clean before use. Use cookware with smooth bottoms. Tiny scratches are not removable but will become less visible in time as a result of cleaning.
	Cookware has been slid across the cooktop surface.	
Areas of discoloration on the cooktop	Improper cookware being used.	<ul style="list-style-type: none"> Marks from aluminum and copper pans as well as mineral deposits from water or food can be removed with the cleaning cream.
Plastic melted to the surface	Hot cooktop came into contact with plastic placed on the hot cooktop.	<ul style="list-style-type: none"> See the <i>Special Care</i> information in the <i>Cleaning the glass cooktop</i> section.
Pitting of the cooktop	Hot sugar mixture spilled on the cooktop.	<ul style="list-style-type: none"> Call a qualified technician for replacement.
Frequent cycling off and on of surface units	Improper cookware being used.	<ul style="list-style-type: none"> Use only flat cookware to minimize cycling.
Electric Coil Models		
Surface units not functioning properly	The surface units are not plugged in solidly.	<ul style="list-style-type: none"> With the controls off, check to make sure the surface unit is plugged completely into the receptacle.
	The surface unit controls improperly set.	<ul style="list-style-type: none"> Check to see the correct control is set for the surface unit you are using.
	The drip pans are not set securely in the cooktop.	<ul style="list-style-type: none"> With the controls off, check to make sure the drip pan is in the recess in the cooktop and that the opening in the pan lines up with the receptacle.
Cooktop feels hot	Large pans hold heat close to the cooktop.	<ul style="list-style-type: none"> Choose a pan that matches the size of the surface unit you are using.
	The oven vent is blocked.	<ul style="list-style-type: none"> Pans on the right rear surface unit block air flow from the oven vent and cause the cooktop to get hot.

Before You Call For Service...



Troubleshooting Tips

Problem	Possible Causes	What To Do
Clock and timer do not work	A fuse in your home may be blown or the circuit breaker tripped.	<ul style="list-style-type: none"> • Replace the fuse or reset the circuit breaker.
	Oven controls improperly set.	<ul style="list-style-type: none"> • See the <i>Using the clock and timer</i> section.
Oven light does not work	Light bulb is loose or defective.	<ul style="list-style-type: none"> • Tighten or replace the bulb.
	Switch operating light is broken.	<ul style="list-style-type: none"> • Call for service.
Oven temperature too hot or too cold	Oven thermostat needs adjustment.	<ul style="list-style-type: none"> • See the <i>Adjust the oven thermostat—Do it yourself!</i> section.
Oven will not work	A fuse in your home may be blown or the circuit breaker tripped.	<ul style="list-style-type: none"> • Replace the fuse or reset the circuit breaker.
	Oven controls improperly set.	<ul style="list-style-type: none"> • See the <i>Using the oven</i> section.
Control signals after entering cooking time or delay start	You forgot to enter a bake temperature or cleaning time.	<ul style="list-style-type: none"> • Press the BAKE pad and desired temperature or the SELF CLEAN pad and desired clean time.
Food does not bake or roast properly	Oven controls improperly set.	<ul style="list-style-type: none"> • See the <i>Using the oven</i> section.
	Shelf position is incorrect or the shelf is not level.	<ul style="list-style-type: none"> • See the <i>Using the oven</i> section.
	Incorrect cookware or cookware of improper size being used.	<ul style="list-style-type: none"> • See the <i>Using the oven</i> section.
	Oven thermostat needs adjustment.	<ul style="list-style-type: none"> • See the <i>Adjust the oven thermostat—Do it yourself!</i> section.
Food does not broil properly	Door not open to the broil stop position as recommended.	<ul style="list-style-type: none"> • See the <i>Using the oven</i> section.
	Oven controls improperly set.	<ul style="list-style-type: none"> • Make sure you press the BROIL HI/LO pad.
	Improper shelf position being used.	<ul style="list-style-type: none"> • See the <i>Broiling Guide</i>.
	Cookware not suited for broiling.	<ul style="list-style-type: none"> • Use the broiling pan and grid that came with your oven.
	Aluminum foil used on the the broiling pan and grid has not been fitted properly and slit as recommended.	<ul style="list-style-type: none"> • See the <i>Using the oven</i> section.
	In some areas the power (voltage) may be low.	<ul style="list-style-type: none"> • Preheat the broil element for 10 minutes. • Broil for the longest period of time recommended in the <i>Broiling Guide</i>.

Problem	Possible Causes	What To Do
Oven will not self-clean	The oven temperature is too high to set a self-clean operation. Oven controls improperly set.	<ul style="list-style-type: none"> Allow the oven to cool to room temperature and reset the controls. See the <i>Using the self-cleaning oven</i> section.
"Crackling" or "popping" sound	This is the sound of the metal heating and cooling during both the cooking and cleaning functions.	<ul style="list-style-type: none"> This is normal.
Excessive smoking	Excessive soil.	<ul style="list-style-type: none"> Press the CLEAR/OFF pad. Open the windows to rid the room of smoke. Wait until the LOCKED DOOR light goes off. Wipe up the excess soil and reset the clean cycle.
Oven door will not open after a clean cycle	Oven too hot.	<ul style="list-style-type: none"> Allow the oven to cool below locking temperature.
Oven not clean after a clean cycle	Oven controls not properly set. Oven was heavily soiled.	<ul style="list-style-type: none"> See the <i>Using the self-cleaning oven</i> section. Clean up heavy spillovers before starting the clean cycle. Heavily soiled ovens may need to self-clean again or for a longer period of time.
"LOCK DOOR" flashes in the display	The self-clean cycle has been selected but the door is not closed.	<ul style="list-style-type: none"> Close the oven door.
LOCKED DOOR light is on when you want to cook	The oven door is locked because the temperature inside the oven has not dropped below the locking temperature.	<ul style="list-style-type: none"> Press the CLEAR/OFF pad. Allow the oven to cool.
"F— and a number or letter" flash in the display	You have a function error code. If the function code repeats.	<ul style="list-style-type: none"> Press the CLEAR/OFF pad. Allow the oven to cool for one hour. Put the oven back into operation. Disconnect all power to the range for at least 30 seconds and then reconnect power. If the function error code repeats, call for service.
Display goes blank	A fuse in your home may be blown or the circuit breaker tripped. The clock is in the black-out mode.	<ul style="list-style-type: none"> Replace the fuse or reset the circuit breaker. See the Special features of your oven control section.

Before You Call For Service...



Troubleshooting Tips

Problem	Possible Causes	What To Do
Display flashes	Power failure.	<ul style="list-style-type: none"> Reset the clock.
Unable to get the display to show "SF"	Oven control pads were not pressed properly.	<ul style="list-style-type: none"> The BAKE and BROIL HI/LO pads must be pressed at the same time and held for 3 seconds.
Power outage, clock flashes	Power outage or surge.	<ul style="list-style-type: none"> Reset the clock. If the oven was in use, you must reset it by pressing the CLEAR/OFF pad, setting the clock and resetting any cooking function.
"Burning" or "oily" odor emitting from the vent	This is normal in a new oven and will disappear in time.	<ul style="list-style-type: none"> To speed the process, set a self-clean cycle for a minimum of 3 hours. See the <i>Using the self-cleaning oven</i> section.
Strong odor	An odor from the insulation around the inside of the oven is normal for the first few times the oven is used.	<ul style="list-style-type: none"> This is temporary.
Fan noise	A cooling fan may automatically turn on and off to cool internal parts.	<ul style="list-style-type: none"> This is normal. The cooling fan will turn off and on.

GE Service Protection Plus™

GE, a name recognized worldwide for quality and dependability, offers you Service Protection Plus™—comprehensive protection on all your appliances—**No Matter What Brand!**

Benefits Include:

- Backed by GE
- All brands covered
- Unlimited service calls
- All parts and labor costs included
- No out-of-pocket expenses
- No hidden deductibles
- One 800 number to call

***We'll Cover Any Appliance.
Anywhere. Anytime.****

You will be completely satisfied with our service protection or you may request your money back on the remaining value of your contract. No questions asked. It's that simple.

Protect your refrigerator, dishwasher, washer and dryer, range, TV, VCR and much more—**any brand!** Plus there's no extra charge for emergency service and low monthly financing is available. Even icemaker coverage and food spoilage protection is offered. You can rest easy, knowing that all your valuable household products are protected against expensive repairs.

Place your confidence in GE and call us in the U.S. toll-free at **800-626-2224** for more information.

*All brands covered, up to 20 years old, in the continental U.S.

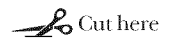

Please place in envelope and mail to:

General Electric Company
Warranty Registration Department
P.O. Box 32150
Louisville, KY 40232-2150

Consumer Product Ownership Registration

Dear Customer:

Thank you for purchasing our product and thank you for placing your confidence in us.

We are proud to have you as a customer!

Follow these three steps to protect your new appliance investment:

1 Complete and mail your Consumer Product Ownership Registration today. Have the peace of mind of knowing we can contact you in the unlikely event of a safety modification.

2 After mailing the registration below, store this document in a safe place. It contains information you will need should you require service. Our service number is 800 GE CARES (800-432-2737).

3 Read your Owner's Manual carefully. It will help you operate your new appliance properly. If you have questions, or need more information, call the GE Answer Center® 800.626.2000.

Model Number

Serial Number

Important: If you did not get a registration card with your product, detach and return the form below to ensure that your product is registered, or register online at www.geappliances.com.

 Cut here

Consumer Product Ownership Registration



Model Number

Serial Number

Mr. Ms. Mrs. Miss

First Name

Last Name

Street Address

Apt. #

E-mail Address

City

State

Zip Code

Date Placed In Use
Month

Day

Year

Phone Number

Occasionally, we may allow selected companies to send you information.

Check here if you do not want this information.



GE Appliances

General Electric Company
Louisville, Kentucky
www.geappliances.com

GE Electric Range Warranty

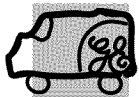

All warranty service provided by our Factory Service Centers or an authorized Customer Care® technician. For service, call 800-GE-CARES.

For The Period Of: GE Will Replace:

One Year

From the date of the original purchase

Any part of the range which fails due to a defect in materials or workmanship. During this **full one-year warranty**, GE will also provide, **free of charge**, all labor and in-home service to replace the defective part.

Five Years

From the date of the original purchase

A replacement glass cooktop if it should: crack due to thermal shock; discolor; crack at the rubber seal between the glass cooktop and the porcelain edge. It will also be replaced if the pattern wears off or if any of the radiant surface units burn out. During this **five-year warranty**, you will be responsible for any labor or in-home service.

What GE Will Not Cover:

- Service trips to your home to teach you how to use the product.
- Replacement of house fuses or resetting of circuit breakers.
- Improper installation.
- Damage to the product caused by accident, fire, floods or acts of God.
- Failure of the product if it is abused, misused, or used for other than the intended purpose or used commercially.
- Incidental or consequential damage to personal property caused by possible defects with this appliance.
- Damage to the glass cooktop caused by use of cleaners other than the recommended cleaning creams.
- Damage to the glass cooktop caused by hardened spills of sugary materials or melted plastic that are not cleaned according to the directions in the Owner's Manual.

This warranty is extended to the original purchaser and any succeeding owner for products purchased for home use within the USA. In Alaska, the warranty excludes the cost of shipping or service calls to your home.

Some states do not allow the exclusion or limitation of incidental or consequential damages. This warranty gives you specific legal rights, and you may also have other rights which vary from state to state. To know what your legal rights are, consult your local or state consumer affairs office or your state's Attorney General.

Warrantor: General Electric Company, Louisville, KY 40225

Safety Instructions

Operating Instructions

Care and Cleaning

Troubleshooting Tips

Customer Service

Service Telephone Numbers.



GE Answer Center® 800.626.2000

The GE Answer Center® is open 24 hours a day, 7 days a week.



In-Home Repair Service 800-GE-CARES (800-432-2737)

Expert GE repair service is only a phone call away.

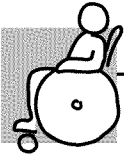

Special Needs Service 800.626.2000

800-TDD-GEAC (800-833-4322)

GE offers, free of charge, a brochure to assist in planning a barrier-free kitchen for persons with limited mobility.



Service Contracts 800-626-2224

Purchase a GE service contract while your warranty is still in effect and you'll receive a substantial discount. GE Consumer Service will still be there after your warranty expires.

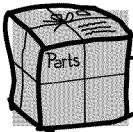

Parts and Accessories 800-626-2002

Individuals qualified to service their own appliances can have parts or accessories sent directly to their homes (VISA, MasterCard and Discover cards are accepted).

Instructions contained in this manual cover procedures to be performed by any user. Other servicing generally should be referred to qualified service personnel. Caution must be exercised, since improper servicing may cause unsafe operation.



Service Satisfaction

If you are not satisfied with the service you receive from GE:

First, contact the people who serviced your appliance.

Next, if you are still not pleased, write all the details—including your phone number—to:

Manager, Customer Relations
 GE Appliances
 Appliance Park
 Louisville, KY 40225

Free Manuals Download Website

<http://myh66.com>

<http://usermanuals.us>

<http://www.somanuals.com>

<http://www.4manuals.cc>

<http://www.manual-lib.com>

<http://www.404manual.com>

<http://www.luxmanual.com>

<http://aubethermostatmanual.com>

Golf course search by state

<http://golfingnear.com>

Email search by domain

<http://emailbydomain.com>

Auto manuals search

<http://auto.somanuals.com>

TV manuals search

<http://tv.somanuals.com>