

# How to get the best from Your Range

## Use and Care Guide

### Contents

Aluminum Foil	4, 21, 25, 27, 29	Roasting	25, 26
Anti-Tip Device	3, 36	Self-Cleaning	29-32
Appliance Registration	2	Shelves	4, 18, 19, 25, 27-29, 33
Automatic Timers & Clock	15, 16	Thermostat Adjustment	24
<b>Care and Cleaning</b>	33-35	Timed Baking	22, 23
Consumer Services	39	Preparation	8, 36
Important Phone Numbers	39	<b>Problem Solver</b>	37, 38
Removal of Packaging Tape	2	<b>Safety Instructions</b>	3-5
Features	6, 7	<b>Surface Cooking</b>	8-14
Model and Serial Numbers	2	Canning Tips	13
<b>Oven</b>	18-32	Cooktop Comparison	8
Baking	19-21	Cookware Tips	11, 12
Broiling	27, 28	Surface Cleaning	14
Lift-Off Oven Door	27-29, 34	Surface Control Settings	10
Oven Control Settings	15-17	Warranty	Back Cover
Oven Interior Light	18, 29, 35	<b>GE Answer Center®</b>	
Oven Vent	4, 35	<b>800.626.2000</b>	
Power Outage	17		

Model RB787

# HOTPOINT

164D2966P215  
39-4753

10-95 CG

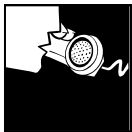

## HELP US HELP YOU...

### Before using your range, read this guide carefully.

It is intended to help you operate and maintain your new range properly.

Keep it handy for answers to your questions.

If you don't understand something or need more help, call:

**GE Answer Center®**

**800.626.2000**

**24 hours a day, 7 days a week**

### How to Remove Packaging Tape

To assure no damage is done to the finish of the product, the safest way to remove adhesive left from packaging tape on new appliances is an application of a household liquid dishwashing detergent, mineral oil or cooking oil. Apply with a soft cloth and allow to soak. Wipe dry and then apply an appliance polish to thoroughly clean and protect the surface.

**NOTE:** The plastic tape must be removed from the chrome trim on range parts. It cannot be removed if it is baked on.

### Write down the model and serial numbers.

You'll find them on a label on the front of the range behind the storage drawer.

These numbers are also on the Consumer Product Ownership Registration Card that came with your range. Before sending in this card, please write these numbers here:

---

Model Number

---

Serial Number

Use these numbers in any correspondence or service calls concerning your range.

### If you received a damaged range...

Immediately contact the dealer (or builder) that sold you the range.

### Save time and money. Before you request service...

Check the Problem Solver in the back of this guide. It lists causes of minor operating problems that you can correct yourself.

---

## IF YOU NEED SERVICE...

To obtain service, see the Consumer Services page in the back of this guide.

We're proud of our service and want you to be pleased. If for some reason you are not happy with the service you receive, here are three steps to follow for further help.

**FIRST**, contact the people who serviced your appliance. Explain why you are not pleased. In most cases, this will solve the problem.

**NEXT**, if you are still not pleased, write all the details—including your phone number—to:

Manager, Consumer Relations  
Hotpoint  
Appliance Park  
Louisville, KY 40225

**FINALLY**, if your problem is still not resolved, write:

Major Appliance Consumer Action Program  
20 North Wacker Drive  
Chicago, IL 60606

# IMPORTANT SAFETY INSTRUCTIONS

Read all instructions before using this appliance.



## IMPORTANT SAFETY NOTICE

- **The California Safe Drinking Water and Toxic Enforcement Act** requires the Governor of California to publish a list of substances known to the state to cause birth defects or other reproductive harm, and requires businesses to warn customers of potential exposure to such substances.
- **The fiberglass insulation in self-clean ovens gives off a very small amount of carbon monoxide during the cleaning cycle.** Exposure can be minimized by venting with an open window or using a ventilation fan or hood.

When using electrical appliances, basic safety precautions should be followed, including the following:

- Use this appliance only for its intended use as described in this guide.
- Be sure your appliance is properly installed and grounded by a qualified technician in accordance with the provided Installation Instructions.
- Do not attempt to repair or replace any part of your range unless it is specifically recommended in this guide. All other servicing should be referred to a qualified technician.
- Have the installer show you the location of the circuit breaker or fuse. Mark it for easy reference.
- Before performing any service, **DISCONNECT THE RANGE POWER SUPPLY AT THE HOUSEHOLD DISTRIBUTION PANEL BY REMOVING THE FUSE OR SWITCHING OFF THE CIRCUIT BREAKER.**

**▲ WARNING**—All ranges can tip and injury could result. To prevent accidental tipping of the range, attach it to the wall and floor by installing the Anti-Tip device supplied.

To check if the device is installed and engaged properly, remove the storage drawer and inspect the rear leveling leg. Make sure it fits securely into the slot.

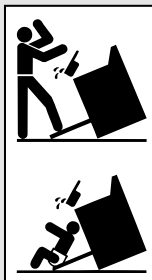

If you pull the range out from the wall for any reason, make sure the device is properly engaged when you push the range back against the wall. If it is not, there is a possible risk of the range tipping over and causing injury if you or a child stand, sit or lean on an open door.

Please refer to the Anti-Tip device information in this guide. Failure to take this precaution could result in tipping of the range and injury.

- **Do not leave children alone**—children should not be left alone or unattended in an area where an appliance is in use. They should never be allowed to sit or stand on any part of the appliance.
- **CAUTION: ITEMS OF INTEREST TO CHILDREN SHOULD NOT BE STORED IN CABINETS ABOVE A RANGE OR ON THE BACKSPASH OF A RANGE—CHILDREN CLIMBING ON THE RANGE TO REACH ITEMS COULD BE SERIOUSLY INJURED.**
- **Teach children not to play with the controls** or any other part of the range.
- **Never leave the oven door open** when you are not watching the range.
- **Always keep combustible wall coverings, curtains or drapes a safe distance from your range.**
- **Do not allow anyone to climb, stand or hang on the door, drawer or cooktop. They could damage the range and even tip it over, causing severe personal injury.**
- **Never wear loose-fitting or hanging garments while using the appliance.** Be careful when reaching for items stored in cabinets over the range. Flammable material could be ignited if brought in contact with hot surface units or heating elements and may cause severe burns.
- **Use only dry pot holders**—moist or damp pot holders on hot surfaces may result in burns from steam. Do not let pot holders touch hot surface units or heating elements. Do not use a towel or other bulky cloth. Such cloths can catch fire on a hot surface unit or heating element.
- **Always keep dish towels, dish cloths, pot holders and other linens a safe distance from your range.**
- **Always keep wooden and plastic utensils and canned food a safe distance away from your range.**



(continued next page)



# IMPORTANT SAFETY INSTRUCTIONS

(continued)

- For your safety, never use your appliance for warming or heating the room.
- **DO NOT STORE OR USE COMBUSTIBLE MATERIALS, GASOLINE OR OTHER FLAMMABLE VAPORS AND LIQUIDS IN THE VICINITY OF THIS OR ANY OTHER APPLIANCE.**
- Keep hood and grease filters clean to maintain good venting and to avoid grease fires.
- Do not let cooking grease or other flammable materials accumulate in or near the range.



- **Do not use water on grease fires. Never pick up a flaming pan.**

Turn the controls off. Smother a flaming pan on a surface unit by covering the pan completely with a well-fitting lid, cookie sheet or flat tray. Use a multi-purpose dry chemical or foam-type fire extinguisher.

Flaming grease outside a pan can be put out by covering it with baking soda or, if available, by using a multi-purpose dry chemical or foam-type fire extinguisher.

Flame in the oven can be smothered completely by closing the oven door and turning the oven off or by using a multi-purpose dry chemical or foam-type fire extinguisher.

- **Do not touch the surface units, the heating elements or the interior surface of the oven.** These surfaces may be hot enough to burn even though they are dark in color. During and after use, do not touch, or let clothing or other flammable materials contact the surface units, areas nearby the surface units or any interior area of the oven; allow sufficient time for cooling first.

Potentially hot surfaces include the cooktop and areas facing the cooktop, the oven vent opening and surfaces near the opening, crevices around the oven door, the edges of the door window and metal trim parts above the door.

**Remember:** The inside surface of the oven may be hot when the door is opened.

- **When cooking pork,** follow the directions exactly and always cook the meat to an internal temperature of at least 170°F. This assures that, in the remote possibility that trichina may be present in the meat, it will be killed and the meat will be safe to eat.

## Oven

- Stand away from the range when opening the oven door. Hot air or steam which escapes can cause burns to hands, face and/or eyes.
- Do not heat unopened food containers. Pressure could build up and the container could burst, causing an injury.
- Keep the oven vent duct unobstructed.
- Keep the oven free from grease buildup.
- Place the oven shelf in the desired position while the oven is cool. If the shelves must be handled when hot, do not let pot holder contact the heating elements.
- Pulling out the shelf to the stop-lock is a convenience in lifting heavy foods. It is also a precaution against burns from touching the hot surfaces of the door or oven walls.
- When using cooking or roasting bags in the oven, follow the manufacturer's directions.
- Do not use your oven to dry newspapers. If overheated, they can catch on fire.
- Do not use oven for a storage area. Items stored in an oven can ignite.
- Do not leave paper products, cooking utensils or food in the oven when not in use.
- After broiling, always take the broiler pan out of the range and clean it. Leftover grease in the broiler pan can catch on fire the next time you use the pan.
- Never leave jars or cans of fat drippings on or near your range.
- Clean only parts listed in this Use and Care Guide.
- Do not use aluminum foil to line oven bottoms, except as suggested in this guide. Improper installation of aluminum foil may result in a risk of electric shock or fire.

## Self-Cleaning Oven

- Do not clean the oven door gasket. The door gasket is essential for a good seal. Care should be taken not to rub, damage or move the gasket.
- Do not use oven cleaners. No commercial oven cleaner or oven liner protective coating of any kind should be used in or around any part of the oven. Residue from oven cleaners will damage the inside of the oven when the self-clean cycle is used.



- **Before self-cleaning the oven**, remove the broiler pan, grid and other cookware.
- **Be sure to wipe up excess spillage before starting the self-cleaning operation.**
- **If the self-cleaning mode malfunctions**, turn the oven off and disconnect the power supply. Have it serviced by a qualified technician.

## Cooktop and Radiant Surface Units

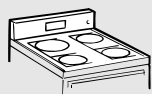

- **Use proper pan size**—Select cookware having flat bottoms large enough to cover the selected surface unit heating element. The use of undersized cookware will expose a portion of the heating element to direct contact and may result in ignition of clothing. Proper relationship of cookware to surface units will also improve efficiency.
- **Clean the cooktop with caution.** If a wet sponge or cloth is used to wipe spills on a hot surface unit, be careful to avoid steam burns. Some cleansers can produce noxious fumes if applied to a hot surface. When the cooktop is cool, use only Cook Top Cleaning Creme brand cleaner to clean the cooktop.
- **Use care when touching the cooktop.** The glass surface of the cooktop will retain heat after the controls have been turned off.
- **Never leave the surface units unattended at high heat settings.** Boilovers cause smoking and greasy spillovers that may catch on fire.
- **Avoid heating an empty pan.** Doing so may damage the cooktop and the pan.
- **Do not allow water, other liquids or grease to remain on the cooktop or the control panel.**
- **Do not operate the radiant surface units if the glass is broken.** Spillovers or cleaning solution may penetrate a broken cooktop and create a risk of electrical shock. Contact a qualified technician immediately should your glass cooktop become broken.
- **Avoid scratching the glass cooktop surface. The cooktop can be scratched with items such as sharp instruments**, or rings or other jewelry and rivets on clothing.
- **Never use the glass cooktop surface as a cutting board.**
- **Do not place or store items on top of the glass cooktop surface when it is not in use.**
- **Do not stand on the glass cooktop.** The weight may cause the top to break.
- **Be careful when placing spoons or other stirring utensils on the glass cooktop surface when it is in use.** They may become hot and could cause burns.
- **To minimize the possibility of burns**, ignition of flammable materials and spillage, the handle of a container should be turned toward the center of the range without extending over nearby surface units.
- **Always turn the surface unit controls to off before removing cookware.**
- **Carefully watch for spillovers or overheating of foods when frying at high or medium high temperatures.**
- **When flaming foods are under the hood**, turn the fan off. The fan, if operating, may spread the flame.
- **Foods for frying should be as dry as possible.** Frost on frozen foods or moisture on fresh foods can cause hot fat to bubble up and over the sides of the pan.
- **Use little fat for effective shallow or deep-fat frying.** Filling the pan too full of fat can cause spillovers when food is added.
- **If a combination of oils or fats will be used in frying, stir together before heating, or as fats melt slowly.**
- **Always heat fat slowly**, and watch as it heats.
- **Use a deep fat thermometer whenever possible** to prevent overheating fat beyond the smoking point.
- **Never try to move a pan of hot fat, especially a deep fat fryer.** Wait until the fat is cool.
- **To avoid possible damage to the cooking surface**, do not apply Cook Top Cleaning Creme to the glass surface when it is hot.
- **After cleaning**, use a dry cloth or paper towel to remove all Cook Top Cleaning Creme residue.
- **Read and follow all instructions and warnings on Cook Top Cleaning Creme labels.**

**SAVE THESE  
INSTRUCTIONS**



# FEATURES OF YOUR RANGE

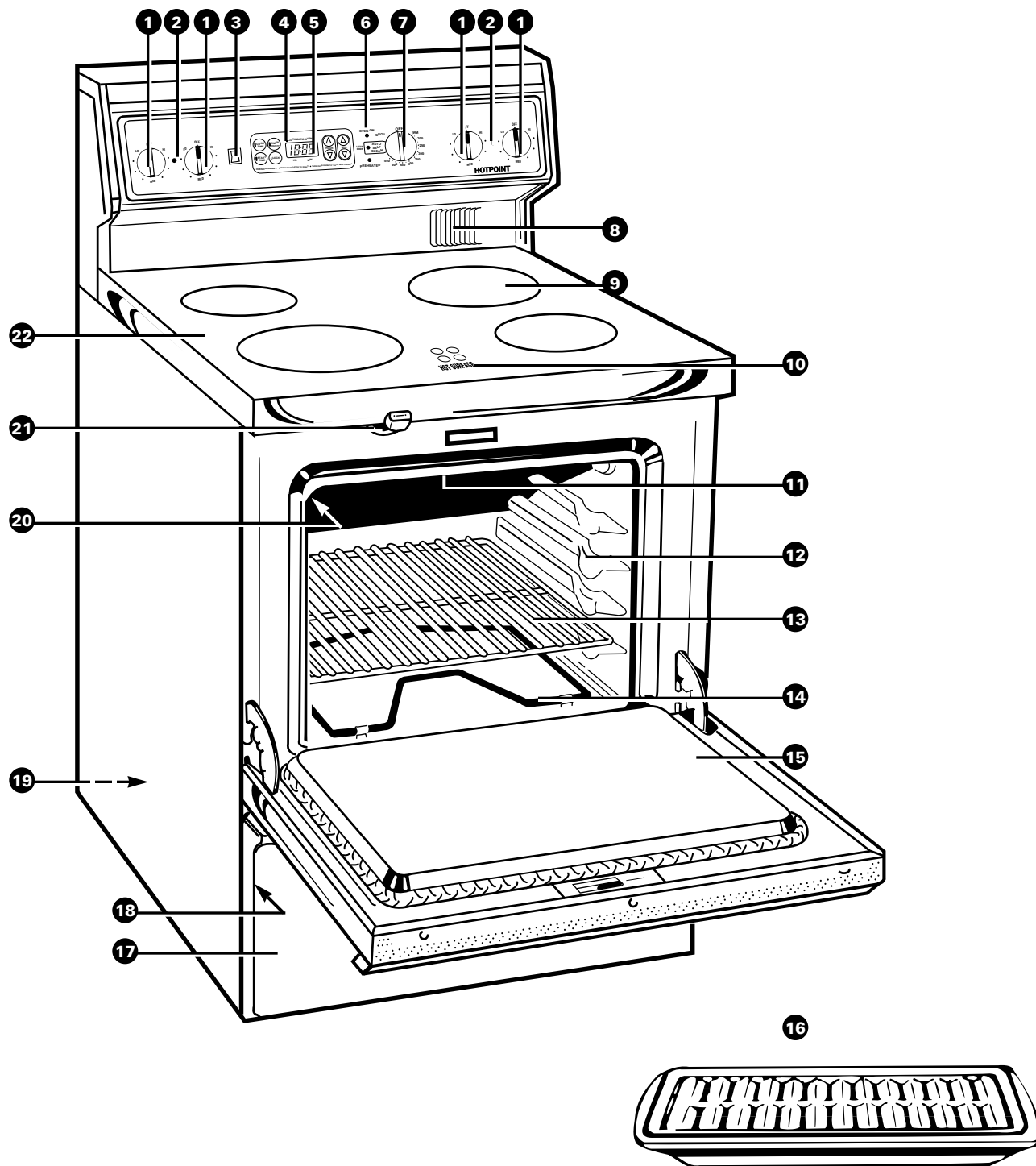

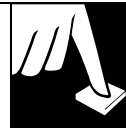

<b>Feature Index</b>	<b>Explained on page</b>
1 <b>Surface Unit Controls</b>	3, 10, 33
2 <b>Surface Unit “On” Indicator Light</b>	10
3 <b>Oven Light Switch</b>	18
4 <b>AUTOMATIC OVEN Light</b>	15, 22, 23
5 <b>Clock and Timer</b>	15, 16
6 <b>OVEN ON Light</b> <b>AUTO SELF CLEAN Light</b> <b>PREHEATED Light</b>	15, 17 15 15, 17
7 <b>Oven Temperature Knob</b>	15, 17, 33
8 <b>Oven Vent Duct</b>	4, 35
9 <b>Cooktop Surface Units</b>	3, 5, 10–14
10 <b>Hot Surface Light</b> Light will glow when the cooktop is hot to the touch.	9, 12
11 <b>Broil Element</b>	27, 28, 33
12 <b>Oven Shelf Supports</b> Shelf positions are suggested in the Baking, Roasting and Broiling sections.	18, 19, 25, 27, 28, 33
13 <b>Oven Shelf with Stop-Locks</b>	4, 18, 19, 25, 27–29, 33
14 <b>Bake Element</b> May be lifted gently for wiping the oven floor.	33
15 <b>Lift-Off Oven Door with Broil Stop Position</b>	27–29, 34
16 <b>Broiler Pan and Grid</b> Do not clean in the self-cleaning oven.	4, 25, 27–29, 34
17 <b>Storage Drawer</b>	3, 35
18 <b>Model and Serial Numbers</b>	2
19 <b>Anti-Tip Device</b>	3, 36
20 <b>Oven Interior Light</b>	18, 29, 35
21 <b>Oven Door Latch</b> Use for self-cleaning only.	19, 22, 25, 27, 29–31
22 <b>Glass Ceramic Cooktop</b>	8, 9, 12, 14



# PREPARATION

## Flooring Under the Range

Your range, like many other household items, is heavy and can settle into soft floor coverings such as cushioned vinyl or carpeting. When moving the range on this type of flooring, it should be installed on a 1/4-inch-thick sheet of plywood (or similar material) as follows: *When the floor covering ends at the front of the range*, the area that the range will rest on should be built up with plywood to the same level or higher than the floor covering. This will allow the range to be moved for cleaning or servicing.

## Leveling the Range

Leveling screws are located on each corner of the base of the range. Remove the bottom drawer and you can level the range on an uneven floor with the use of a nutdriver.

**To remove drawer**, pull the drawer out all the way, tilt up the front and take it out. To replace drawer, insert the glides at the back of the drawer beyond stop on the range glides. Lift the drawer if necessary to insert easily. Let the front of the drawer down, then push in to close.





One of the rear leveling screws will engage the Anti-Tip device (allow for some side to side adjustment). Allow a minimum clearance of 1/8" between the range and the leveling screw that is to be installed into the Anti-Tip device.

## HOW DOES THIS COOKTOP COMPARE WITH YOUR OLD ONE?

Your new cooktop has a radiant glass ceramic cooktop. If you are used to cooking with gas burners or electric surface units, you will notice some differences when you use the radiant cooktop.

The best types of cookware to use, plus heat-up and cool-down times, depend upon the type of burner or surface unit you have.

The following chart will help you to understand the differences between radiant cooktops and any other type of cooktop you may have used in the past.

Type of Cooktop	Description	How It Works
<b>Radiant (Glass Ceramic) Cooktop</b> 	Electric coils under a glass-ceramic cooktop.	Heat travels to the glass surface and then to the cookware, so pans must be flat on the bottom for good cooking results. The glass cooktop stays hot enough to continue cooking after it is turned off. Remove the pan from the surface unit if you want cooking to stop.
<b>Induction</b> 	High frequency induction coils under a glass surface.	Pans must be made of ferrous metals (metal that attracts a magnet). Heat is produced by a magnetic circuit between the coil and the pan. Heats up right away and changes heat settings right away, like a gas cooktop. After turning the control off, the glass cooktop is hot from the heat of the pan, but cooking stops right away.
<b>Electric Coil</b> 	Flattened metal tubing containing electric resistance wire suspended over a drip pan.	Heats by direct contact with the pan and by heating the air under the pan. For best cooking results, use good quality pans. Electric coils are more forgiving of warped pans than radiant or solid disks. Heats up quickly but does not change heat settings as quickly as gas or induction. Electric coils stay hot enough to continue cooking for a short time after they are turned off.
<b>Solid Disk</b> 	Solid cast iron disk sealed to the cooktop surface.	Heats by direct contact with the pan, so pans must be flat on the bottom for good cooking results. Heats up and cools down more slowly than electric coils. The disk stays hot enough to continue cooking after it is turned off. Remove the pan from the solid disk if you want the cooking to stop.
<b>Gas Burners</b> 	Regular or sealed gas burners use either LP gas or natural gas.	Flames heat the pans directly. Pan flatness is not critical to cooking results, but pans should be well balanced. Gas burners heat the pan right away and change heat settings right away. When you turn the control off, cooking stops right away.



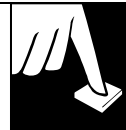

## General Information About Radiant Surface Units

The radiant cooktop features heating units beneath a smooth glass surface. The surface units are shown by outlines on the glass.

**Before you use the cooktop for the first time, clean it with cleaning cream. This helps protect the top and makes clean-up easier.**

**NOTE:** A slight odor is normal when a new cooktop is used for the first time. It is caused by the heating of new parts and insulating materials and will disappear in a short time.

When a surface unit is turned on, coils beneath the surface unit radiate heat through the glass to the cookware. The red glow of the coils will be visible through the glass. It will take the surface unit a few moments to heat up. The coil cycles on and off to maintain your selected control setting. With poor cookware, you will see frequent cycling of the unit off and on. Good, flat cookware will minimize the cycling.

Use only flat-bottomed cookware. Do not let pots boil dry. Overheated metal can bond to glass cooktop. An overheated copper pot may leave a residue that will permanently stain the glass.

Sliding aluminum cookware across the glass may leave metal marks. These metal marks will appear as small scratches. They can be removed with cleaning cream and a razor scraper.

It is safe to place hot cookware from the oven or surface on the glass surface when the surface is cool.

Avoid sliding pans on the glass cooktop. Pan edges that are even slightly rough or grit on the cooktop can cause scratches on the glass.

Even after the surface units are turned off, the glass cooktop retains enough heat to continue cooking. To avoid overcooking, remove pans from the surface units when the food is cooked. Avoid placing anything on the surface unit until it has cooled completely.

The Hot Surface Light will glow when the cooktop is hot to the touch. It is not unusual for the lights to stay lit for 30 minutes.

## Hot Surface Indicator Light

A “HOT SURFACE” light will glow brightly when any radiant element is hot to the touch, and will remain lit after the unit is turned off until the surface is cool enough to touch.

- It comes on when the unit is hot to the touch.
- It stays on even after the unit is turned off.
- It glows brightly until the unit is safe to touch.



A “HOT SURFACE” light will glow brightly when any element is turned on.

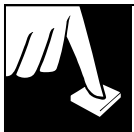

# SURFACE CONTROLS

At both OFF and HI positions, there is a slight niche so control “clicks” at those positions; the word HI marks the highest setting; the lowest setting is the word LO. In a quiet kitchen you may hear slight “clicking” sounds during cooking, indicating the heat settings selected are being maintained.

Switching to higher heat settings always shows a quicker heat change than switching to lower settings.

## How to Set the Controls

1. Push the control knob in.
2. Turn either clockwise or counterclockwise to the desired heat setting.

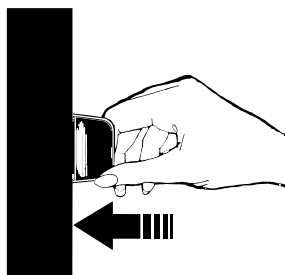

**The control must be pushed in to set only from the OFF position. When the control is in any position other than OFF, it may be turned without pushing it in.**

Be sure you turn the control knob to OFF when you finish cooking.

**The left surface unit indicator light will glow when either the left front or rear surface units are on. The right surface unit indicator light will glow when either the right front or rear surface units are on.**

## Cooking Guide for Using Heat Settings

**HI**—Quick start for cooking; brings water to a boil.

**Medium High**—(Setting halfway between HI and MED) Fast fry, pan broil; maintains a fast boil on large amounts of food.

**MED**—Sauté and brown; maintains a slow boil on large amounts of food.

**Medium Low**—(Setting halfway between MED and LO) Cook after starting at HI; cooks with little water in covered pan.

**LO**—Steam rice, cereal; maintains serving temperature of most foods. Slow cooking and simmering. At LO settings, melt chocolate and butter on small surface unit.

**Cooktop temperatures increase with the number of surface units that are on. With 3 or 4 units turned on, surface temperatures are high so be careful when touching the cooktop. The hot surface indicator light will remain lit after the surface units are off until the surface is cool enough to touch.**

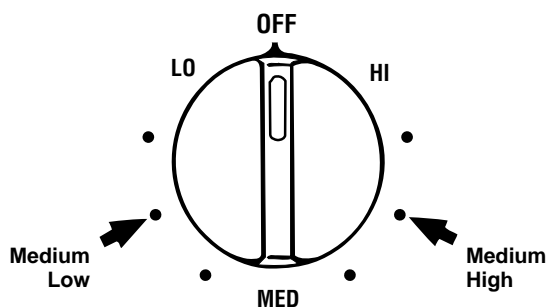

### NOTE:

- At HI, Medium High settings, never leave food unattended. Boilovers cause smoking; greasy spillovers may catch on fire.
- When a surface unit is turned on, the unit can be seen glowing red within a few seconds. The red glow will turn on and off (cycling) to maintain the selected heat setting. With poor cookware, you will see frequent cycling of the unit off and on. Good, flat cookware will minimize the cycling. See the Surface Cookware Tips section.

# SURFACE COOKWARE TIPS



## Types of Cookware

The following information will help you choose cookware which will give good performance.

### **Stainless Steel:** *highly recommended*

Especially good with a sandwich clad bottom. The sandwich bottom combines the benefits of stainless steel (appearance, durability and stability) with the advantages of aluminum or copper (heat conduction, even heat distribution).

### **Aluminum:** *heavy weight recommended*

Good conductivity. Aluminum residue sometimes appears as scratches on the cooktop, but can be removed if cleaned immediately. Because of its low melting point, thin weight aluminum should not be used.

### **Porcelain/enamel:**

Good performance only with a thick, flat, smooth bottom. Avoid boiling dry, as porcelain can melt and fuse to the surface.

### **Copper Bottom:**

Good performance, but copper may leave a residue which can appear as scratches. The residue can be removed, as long as the cooktop is cleaned immediately. However, do not let these pots boil dry. Overheated metal can bond to glass cooktops. An overheated copper pot will leave a residue that will permanently stain the cooktop.

### **Glass-ceramic:** *usable, not recommended*

Poor performance. May scratch surface.

### **Stoneware:** *usable, not recommended*

Poor performance. Will scratch the surface.

### **Cast Iron:** *usable, not recommended*

Poor performance. Will scratch the surface.

## How to Check Pan Performance

Use of correct cookware can affect the cooking performance and cleaning of your cooktop.

The correct cookware reduces the temperature of the cooktop surface and minimizes the chance of spillovers burning onto the cooktop.

**You must use pans with perfectly flat bottoms.**

Some pans may have curved or rounded bottoms or may be warped. If you are unsure of the flatness of your pans you may do this quick test.

Turn your pan upside down on the countertop, place a ruler flat against the pan surface. The bottom of the pan and the straight edge of the ruler should fit flush against each other all the way across. Turn the ruler a full 360 degrees, checking for any space between the ruler and the bottom of the pan.

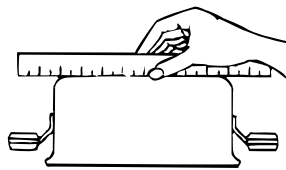

Pans with rounded, curved, ridged or warped bottoms are not recommended.

Another simple test to determine even heat distribution across the cookware bottom is to put one inch of water in the pan. Bring the water to a boil and observe the location of bubbles as the water starts to boil. Good flat cookware will have an even distribution of bubbles over the bottom surface area of the pan. Bubbles localized in only a portion of the bottom indicate uneven contact of the pan to the surface unit, uneven heat transfer or an unsuitable pan.

Use pans that match the diameter of the surface unit. Cooking performance will not be as good if the cookware is either smaller or larger than the surface unit.

- Place only dry pans on the surface units. Do not place lids on the surface units, particularly wet lids.



- We recommend that you use only a flat-bottomed wok. They are available at your local retail store. The bottom of the wok should have the same diameter as the surface unit to insure proper contact.



- Do not use woks that have support rings. This type of wok will not heat on radiant surface units.



- Some special cooking procedures require specific cookware such as pressure cookers, deep fat fryers, etc. All cookware must have flat bottoms and be the correct size. The cookware should also be covered, if applicable to the cooking process.

(continued next page)



## SURFACE COOKWARE TIPS

(continued)

### SPECIAL CAUTIONS FOR GLASS COOKTOPS



- Never cook directly on the glass. Always use cookware.



- Do not use the surface as a cutting board.



- Always place the pan in the center of the surface unit you are cooking on.



- Do not slide cookware across the cooktop because it can scratch the glass—**the glass is scratch resistant, not scratch proof.**



- Don't store heavy items above the cooktop. If they drop onto the cooktop, they can cause damage.

### Deep Fat Frying

Do not overfill cookware with fat that may spill over when adding food. Frosty foods bubble vigorously. Watch food frying at high temperatures. Keep the range and hood clean from grease.

# HOME CANNING TIPS



## Canning should be done on the cooktop only.

Pots that extend beyond 1 inch of the surface unit circle are not recommended for most surface cooking. However, when canning with water-bath or pressure canner, larger-diameter pots may be used. This is because boiling water temperatures (even under pressure) are not harmful to the cooktop surfaces surrounding the surface units.

HOWEVER, DO NOT USE LARGE DIAMETER CANNERS OR OTHER LARGE DIAMETER POTS FOR FRYING OR BOILING FOODS OTHER THAN WATER. Most syrup or sauce mixtures—and all types of frying—cook at temperatures much higher than boiling water. Such temperatures could eventually harm the glass cooktop surfaces.

## Observe the Following Points in Canning

1. Be sure the canner fits over the center of the surface unit. If your cooktop or its location does not allow the canner to be centered on the surface unit, use smaller diameter pots for good canning results.
2. Flat-bottomed canners must be used. Do not use canners with flanged or rippled bottoms (often found in enamelware) because they don't make enough contact with the surface units and take too long to boil water.



### Flat-bottomed canners are recommended.

3. When canning, use recipes and procedures from reputable sources. Reliable recipes and procedures are available from the manufacturer of your canner; manufacturers of glass jars for canning, such as Ball and Kerr; and the United States Department of Agriculture Extension Service.
4. Remember that canning is a process that generates large amounts of steam. To avoid burns from steam or heat, be careful when canning.

**NOTE:** If your house has low voltage, canning may take longer than expected, even though directions have been carefully followed. The process time will be shortened by:

- (1) using a pressure canner, and
- (2) starting with HOT tap water for fastest heating of large quantities of water.

### CAUTION:

Safe canning requires that harmful microorganisms are destroyed and that the jars are sealed completely. When canning foods in a water-bath canner, a gentle but steady boil must be maintained for the required time. When canning foods in a pressure canner, the pressure must be maintained for the required time.

After you have adjusted the controls, it is very important to make sure the prescribed boil or pressure levels are maintained for the required time.

The cooktop surface units have temperature limiters that prevent the glass cooktop from getting too hot. If the bottom of your canner is not flat, the surface unit can overheat, triggering the temperature limiters to turn the unit off for a time. This will stop the boil or reduce the pressure in the canner.

Since you must make sure to process the canning jars for the prescribed time, with no interruption in processing time, you do not can on any of the cooktop surface units if your canner is not flat enough.

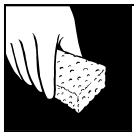

# SURFACE CLEANING

## Glass Ceramic Cooktop Cleaning

Cleaning of glass ceramic cooktops is different from cleaning a standard porcelain finish. To maintain and protect the surface of your new glass ceramic cooktop follow these basic steps.

**DAILY CLEANING: Use only Cook Top Cleaning Creme on Glass Ceramic.**

**For normal, light soil:**

1. Rub a few drops (less is better) of Cook Top Cleaning Creme onto the soiled area using a damp paper towel. Wipe until all soil and creme are removed. Frequent cleaning leaves a protective coating which is essential in preventing scratches and abrasions.
2. Clean the surface with Cook Top Cleaning Creme after each use.

**For heavy, burned on soil:**

1. Apply a few drops of Cook Top Cleaning Creme to the (cool) soiled area.
2. Using a damp paper towel, rub creme into the burned on area. As with any burned on spill, this may require some effort.
3. Carefully scrape remaining soil with the razor scraper. Hold the scraper at a 30° angle against the ceramic surface.
4. If any soil remains, repeat the steps listed above. For additional protection, after all soil has been removed, polish the entire surface with the Cook Top Cleaning Creme.
5. Buff with a dry paper towel.

**NOTE:**

- Using a razor scraper will not damage the surface if the 30° angle is maintained.
- Be sure to use a new, sharp razor scraper. Do not use a dull or nicked blade.
- **Store the razor blade out of reach of children.**

**Special Care:**

**Sugary spillovers** (such as jellies, fudge, candy syrups) or **melted plastics** can cause pitting of the surface of your cooktop (not covered by the warranty) unless the spill is removed while still hot. **Special care should be taken when removing hot substances.** Follow these instructions carefully and remove the soil while the spill is still hot.

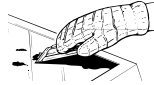
1. Turn off all the surface units affected by the spillover. Remove hot pans.
2. Wearing an oven mitt, hold the razor scraper at a 30° angle to the cooktop and scrape the hot spill to a cool area outside the surface unit. 
3. With the spill in a cool area, use a dry paper towel to remove any excess. Any spillover remaining should be left until the surface of the cooktop has cooled. Do not continue to use the soiled surface unit until all of the spillover has been removed. Follow the steps under Heavy Soil to continue the cleaning process.

**General Information:**

As the Cook Top Cleaning Creme cleans, it leaves a protective coating on the cooktop surface. This coating helps to prevent build-up of mineral deposits (water spots) and will make future cleaning easier. Dishwashing detergents remove this protective coating and therefore make the cooktop more susceptible to staining.

**To conveniently order more creme and/or scrapers for cleaning your radiant range, please call our toll free number:**

<b>National Parts Center</b>	<b>800-626-2002</b>
Creme 10 oz.	# WB02X8273
Scraper	# WX5X1614
Creme and scraper kit	# WB64X5027

## PRECAUTIONS

- Most cleaners contain ammonia, chemicals and abrasives which can damage the surface of your cooktop. **Use only the Cook Top Cleaning Creme for proper cleaning and protection of your glass ceramic surface.**
- If you slide **aluminum or copper cookware** across the surface of your cooktop, they may leave **metal markings which appear as scratches**. If this should happen, use the razor scraper and Cleaning Creme to remove these markings. Failure to remove these residues immediately may leave permanent marks.
- Water stains (mineral deposits) are removable using Cook Top Cleaning Creme or full strength white vinegar.
- If pots with a thin overlay of aluminum, copper or enamel are allowed to boil dry, the overlay may bond with the glass ceramic and leave a black discoloration. This should be removed immediately before heating again or the discoloration may be permanent.
- Use of window cleaner may leave an iridescent film on the cooktop. Cook Top Cleaning Creme will remove this discoloration.

**Read and follow all instructions and warnings on Cook Top Cleaning Creme labels.**

# FEATURES OF YOUR OVEN CONTROL

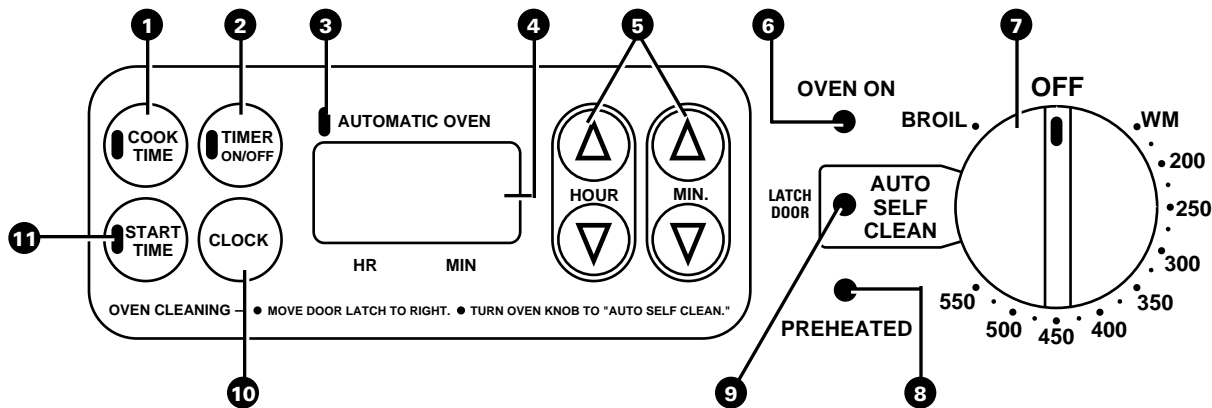

1. **COOK TIME.** Press this pad and then press the HOUR and MIN. pads to set the amount of time you want your food to cook. Turn the Oven Temperature knob to the desired temperature. The oven will shut off after the Cook Time has run out. The COOK TIME indicator light will flash along with the OVEN ON indicator light at the end of a timed cooking operation.
2. **TIMER ON/OFF.** Press this pad to select the timer feature. The timer does not control oven operations. The timer can time up to 11 hours and 59 minutes.  
**To set the timer,** first press the TIMER ON/OFF pad. Press the HOUR and MIN. pads to change the time.  
**To cancel the timer,** press the TIMER ON/OFF pad until the display clears.
3. **AUTOMATIC OVEN Light.** This lights any time the oven has been programmed for a timed oven operation.
4. **TIME DISPLAY.** Shows the time of day and the times set for the timer on automatic oven operations.
5. **HOUR and MIN. pads.** These pads allow you to set times up to 11 hours and 59 minutes.
6. **OVEN ON Light.** Glows any time the oven is heating. The light will flash at the end of a timed oven operation, reminding you to turn the Oven Temperature knob to OFF.
7. **OVEN TEMPERATURE Knob.** Turn this knob to the temperature or function you want. See the Baking, Roasting, Broiling and Self-Cleaning sections.
8. **PREHEATED Indicator Light.** Glows when the oven reaches your selected temperature.
9. **AUTO SELF CLEAN Light.** Glows when the oven is in the Self-Clean cycle. After the Self-Clean Cycle, the light will flash. Unlatch the door and turn the Oven Temperature knob to OFF.
10. **CLOCK.** Press this pad before setting the clock. To set the clock, first press the CLOCK pad. Then press the HOUR and MIN. pads to change the time of day.
11. **START TIME.** Press this pad and the HOUR and MIN. pads to delay the starting of your oven up to 11 hours and 59 minutes.

**If “F—and a number” flash in the display and the oven control signals, this indicates function error code.** If function error code appears during the self-cleaning function, check the oven door latch—the latch handle may have been moved, even if only slightly, from the latched position. Make sure handle is to the right as far as it will go. Turn the Oven Temperature knob to OFF. Allow the oven to cool for one hour. If function error code repeats, disconnect power to the range and call for service.



# OVEN CONTROL, CLOCK AND TIMER

## Automatic Clock

The clock must be set for the automatic oven timing functions to work properly. The time of day cannot be changed during a Timed Baking or Self-Cleaning cycle.

### To Set the Clock



1. Press the CLOCK pad.

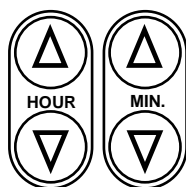

2. Press the HOUR and MIN. pads to set the time of day. The clock will start keeping time within one

minute of releasing the pads. You may press the CLOCK pad again to immediately start the clock.

### To Reset the Clock

1. Press the CLOCK pad, the display will be blank. Press the CLOCK pad again, the display will flash.
2. Press the HOUR and MIN. pads to set the correct time of day.
3. Press the CLOCK pad again for an immediate start.

### To Blank Out the Clock

If you have several clocks in your kitchen, you may wish to blank the time of day display of your range. If so, press the CLOCK pad. Although you cannot see it, the clock maintains the correct time of day. It will reappear for the duration of any function that displays a Start Time or Cook Time. Press the CLOCK pad again to bring back the display.

## Timer

The timer is a minute timer and does not control oven operations.

The maximum setting on the timer is 11 hours and 59 minutes.

### To Set the Timer



1. Press the TIMER ON/OFF pad.
2. Press the HOUR and MIN. pads until the amount of time you want shows in the display. The timer will start automatically within a few seconds of releasing the pad.

When the countdown is finished the control will beep until the TIMER ON/OFF pad is pressed.

### To Reset the Timer

If the display is still showing the time remaining, you may change it by pressing the HOUR and MIN. pads until the time you want appears in the display.

If the remaining time is not in the display, recall the remaining time by pressing the TIMER ON/OFF pad and then pressing the HOUR and MIN. pads until the new time you want shows on the display.

### To Cancel the Timer

**To cancel the timer**, the remaining time must be in the display. To recall the time remaining, press the TIMER ON/OFF pad once. To cancel the timer press the TIMER ON/OFF pad again.



# OVEN CONTROL, CLOCK AND TIMER



## Power Outage

When the power is restored the display will flash “PF” for Power Failure until a pad is pressed or the knob is turned. Reset the clock to the correct time of day.

**If your oven was set for a timed oven operation when the power outage occurred,** the clock and all programmed functions must be reset. To reset them, first turn the Oven Temperature knob back to OFF, reset the clock, functions and knob back to the way they were before the power outage.

## Oven Temperature Knob

The oven temperature knob maintains the temperature you set from WARM to 550°F. It also has an OFF, BROIL and an AUTO SELF CLEAN setting.

**The PREHEATED light** glows when the oven reaches your selected temperature.

**The OVEN ON light** will glow any time the Oven Temperature knob is not in the OFF position and is set on a temperature or a function.

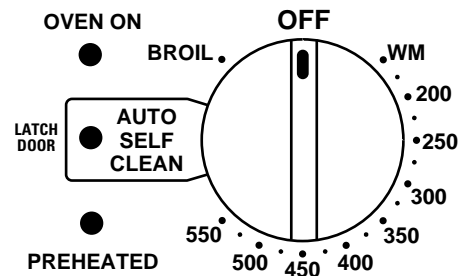



# USING YOUR OVEN

## Before Using Your Oven

1. Look at the controls. Be sure you understand how to set them properly.
2. Check the oven interior. Look at the shelves. Take a practice run at removing and replacing them properly to give sure, sturdy support.
3. Read over the information and tips that follow.
4. Keep this guide handy so you can refer to it, especially during the first weeks of using your new range.

**NOTE:** You may notice a “burning” or “oily” smell the first few times you turn your oven on. This is normal in a new oven and will disappear in a short time. See the Operating the Self-Cleaning Oven section.

## Oven Shelves

The shelves are designed with stop-locks so when placed correctly on the shelf supports, they will stop before coming completely out of the oven and will not tilt when you are removing food from them or placing food on them.

When placing cookware on a shelf, pull the shelf out to the bump on the shelf support. Place the cookware on the shelf, then slide the shelf back into the oven. This will eliminate reaching into the hot oven.

To remove the shelves from the oven, pull them toward you, tilt front end upward and pull them out.

To replace, place the shelf on the shelf support with the stop-locks (curved extension of the shelf) facing up and toward the rear of the oven. Tilt up front and push the shelf toward the back of the oven until it goes past the bump on the shelf support. Then lower the front of the shelf and push it all the way back.

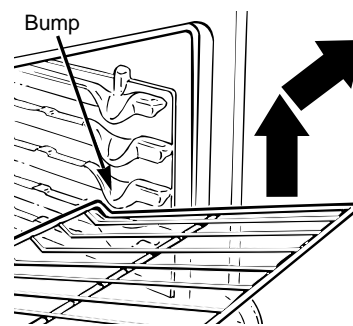

## Shelf Positions

The oven has four shelf supports identified in this illustration as A (bottom), B, C and D (top). Shelf positions for cooking are suggested in the Baking, Roasting and Broiling sections.

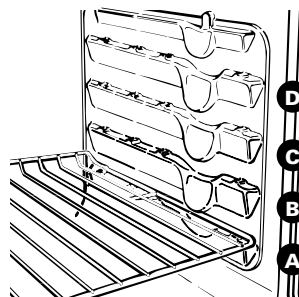

## Automatic Oven Shut Off

As a safety feature, this oven will automatically shut itself off if it has been left on for more than 12 hours.

## Oven Light

Use the switch on the control panel to turn the light on and off.



# BAKING



**Do not lock the oven door with the latch during baking. The latch is used for self-cleaning only.**

Your oven temperature is controlled very accurately using an oven control system. We recommend that you operate the range for a number of weeks using the time given on recipes as a guide to become familiar with your new oven's performance. If you think an adjustment is necessary, see the Adjust the Oven Thermostat section. It lists easy *Do It Yourself* instructions on how to adjust the thermostat.

**NOTE:** When the oven is hot, the top and outside surfaces of the range get hot too.

## How to Set Your Range for Baking

**To avoid possible burns,** place the shelves in the correct position before you turn the oven on.

1. Turn the Oven Temperature knob to the temperature you desire. The OVEN ON indicator light will glow when the Oven Temperature knob is turned on.

2. When the temperature inside the oven reaches the set temperature, the PREHEATED indicator light will glow and tone will sound. Place food in the oven.
3. Check food for doneness at minimum time on recipe. Cook longer if necessary.
4. Turn the Oven Temperature knob to OFF and then remove the foods.

## Oven Shelves

Arrange the oven shelf or shelves in the desired locations while the oven is cool. The correct shelf position depends on the kind of food and the browning desired. As a general rule, place most foods in the middle of the oven, on either shelf position B or C. See the chart for suggested shelf positions.

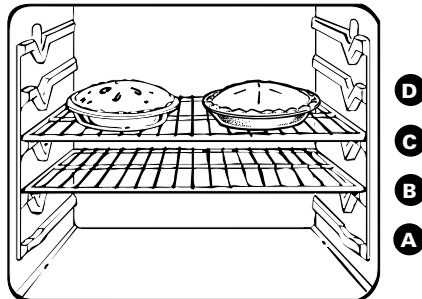

Type of Food	Shelf Position
Angel food cake	A
Biscuits or muffins	B or C
Cookies or cupcakes	B or C
Brownies	B or C
Layer cakes	B or C
Bundt or pound cakes	A or B
Pies or pie shells	B or C
Frozen pies	A (on cookie sheet)
Casseroles	B or C
Roasting	A or B

(continued next page)



# BAKING

(continued)

## Preheating

Preheating is necessary for good results when baking cakes, cookies, pastry and breads. For most casseroles and roasts, preheating is not necessary. For ovens without a preheat indicator light or tone, preheat 10 minutes. After the oven is preheated, place the food in the oven as quickly as possible to prevent heat from escaping.

Preheat the oven if the recipe calls for it. Preheat means bringing the oven up to the specified temperature before putting the food in the oven. To preheat, set the oven at the correct temperature—selecting a higher temperature does not shorten preheat time.

## Baking Pans

Use the proper baking pan. The type of finish on the pan determines the amount of browning that will occur.

- Dark, rough or dull pans absorb heat resulting in a browner, crisper crust. Use this type for pies.
- Shiny, bright and smooth pans reflect heat, resulting in a lighter, more delicate browning. Cakes and cookies require this type of pan.
- Glass baking dishes also absorb heat. When baking in glass baking dishes, the temperature may need to be reduced by 25°F.
- If you are using dark non-stick pans, you may find that you need to reduce the oven temperature 25°F. to prevent overbrowning.

## Pan Placement

For even cooking and proper browning, there must be enough room for air circulation in the oven. Baking results will be better if baking pans are centered as much as possible rather than being placed to the front or to the back of the oven.

Pans should not touch each other or the walls of the oven. Allow 1- to 1½-inch space between pans as well as from the back of the oven, the door and the sides. If you need to use two shelves, stagger the pans so one is not directly above the other.

## Baking Guides

When using prepared baking mixes, follow package recipe or instructions for the best baking results.

## Cookies

When baking cookies, flat cookie sheets (without sides) produce better-looking cookies. Cookies baked in a jelly roll pan (short sides all around) may have darker edges and pale or light browning may occur.

Do not use a cookie sheet so large that it touches the walls or the door of the oven. Never entirely cover a shelf with a large cookie sheet.

For best results, use only one cookie sheet in the oven at a time.

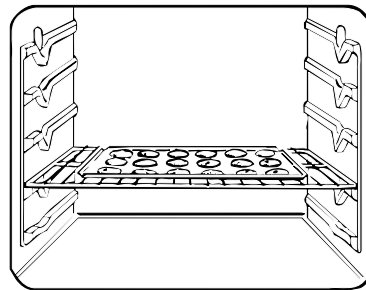

(continued next page)

# BAKING

(continued)



## Pies

For best results, bake pies in dark, rough or dull pans to produce a browner, crisper crust. Frozen pies in foil pans should be placed on an aluminum cookie sheet for baking since the shiny foil pan reflects heat away from the pie crust; the cookie sheet helps retain it.

## Cakes

When baking cakes, warped or bent pans will cause uneven baking results and poorly shaped products. A cake baked in a pan larger than the recipe recommends will usually be crisper, thinner and drier than it should be. If baked in a pan smaller than recommended, it may be undercooked and batter may overflow. Check the recipe to make sure the pan size used is the one recommended.

## Aluminum Foil

Never entirely cover a shelf with aluminum foil. This will disturb the heat circulation and result in poor baking. A smaller sheet of foil may be used to catch a spillover by placing it on a lower shelf several inches below the food.

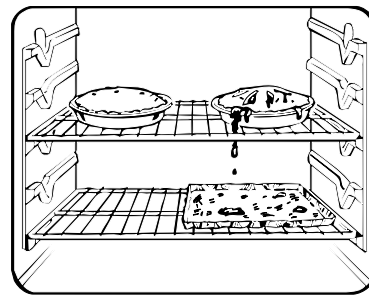

## Don't Peek

Set the timer for the estimated cooking time and do not open the door to look at your food. Most recipes provide minimum and maximum baking times such as "bake 30-40 minutes." DO NOT open the door to check until the minimum time. Opening the oven door frequently during cooking allows heat to escape and makes baking times longer. Your baking results may also be affected.



## TIMED BAKING

(on some models)

### How to Time Bake

**Do not lock the oven door with the latch during timed baking. The latch is used for self-cleaning only.**

The oven control allows you to turn the oven on or off automatically at specific times that you set. Examples of Immediate Start (oven turns on now and you set it to turn off automatically) and Delay Start (setting the oven to turn on automatically at a later time and turn off automatically) will be described.

**NOTE:** Before beginning, make sure the oven clock shows the correct time of day.



**To set the clock,** first press the CLOCK pad. Then press the HOUR and MIN. pads until the correct time of day is displayed.

### How to Set Immediate Start and Automatic Stop

**To avoid possible burns,** place the shelves in the correct position before you turn the oven on.

The oven will turn on immediately and cook for a selected length of time. At the end of baking time, the oven will turn off automatically.



1. Press the COOK TIME pad.  
The COOK TIME and AUTOMATIC OVEN lights will glow and the OVEN ON indicator light will flash.

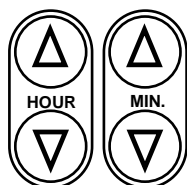

2. Press the HOUR and MIN. pads until the desired length of baking time appears in the display.

3. Turn the Oven Temperature knob to the desired temperature. The OVEN ON indicator light will glow.

4. The oven will turn on. When the temperature inside the oven reaches your preset temperature, the control will beep and the PREHEATED indicator light will glow.
5. When the oven automatically turns off, the OVEN ON and COOK TIME indicator lights will flash and the control will beep continuously until the Oven Temperature knob is turned to OFF.
6. Remove the food from the oven. Remember, foods that are left in the oven continue cooking after the controls are off.

**NOTE:** Foods that spoil easily such as milk, eggs, fish, stuffings, poultry and pork should not be allowed to sit for more than one hour before or after cooking. Room temperature promotes the growth of harmful bacteria. Be sure that the oven light is off because heat from the bulb will speed harmful bacteria growth.

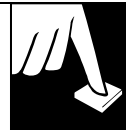

## How to Set Delay Start and Automatic Stop

### Easy Steps:

1. Press the COOK TIME pad.
2. Press the HOUR and MIN. pads to set the desired length of baking time.
3. Press the START TIME pad.
4. Press the HOUR and MIN. pads until the desired Start Time appears in the display.
5. Turn the Oven Temperature knob to the desired temperature.

**To avoid possible burns,** place the shelves in the correct position before you program the oven.

You can set the oven control to delay-start the oven, cook for a specific length of time and then turn off automatically.



1. Press the COOK TIME pad.  
The COOK TIME and AUTOMATIC OVEN lights will glow and the OVEN ON indicator light will flash.

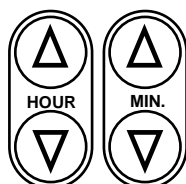

2. Press the HOUR and MIN. pads until the desired length of baking time appears in the display.



3. Press the START TIME pad.  
The START TIME indicator will glow.

4. Press the HOUR and MIN. pads until the desired Start Time appears.
5. Turn the Oven Temperature knob to the desired temperature. The OVEN ON indicator light will glow.
6. The oven will turn on automatically at the time you set and cook for the length of time you set. When the oven automatically turns off, the COOK TIME and OVEN ON indicator lights will flash and the control will beep continuously until the Oven Temperature knob is turned to OFF.
7. Remove the food from the oven. Remember, even though the oven shuts off automatically, foods continue cooking after controls are off.

### NOTE:

- The low temperature zone of this range (between WARM and 200°F.) is available to keep hot cooked foods warm. Food kept in the oven longer than 2 hours at these low temperatures may spoil.
- Foods that spoil easily such as milk, eggs, fish, stuffings, poultry and pork should not be allowed to sit for more than one hour before or after cooking. Room temperature promotes the growth of harmful bacteria. Be sure that the oven light is off because heat from the bulb will speed harmful bacteria growth.

## Questions and Answers

**Q. Can I use the minute timer during oven cooking?**

**A.** The minute timer can be used during any cooking function.

**Q. Can I change the time of day on the clock while I'm Time Baking in the oven?**

**A.** The time of day on the clock should not be changed during any program that uses the oven timer. You must either stop those programs or wait until they are finished before changing the time.



## ADJUST THE OVEN THERMOSTAT— *DO IT YOURSELF!*

**You may find that your new oven cooks differently than the one it replaced.** We recommend that you use your new oven for a few weeks to become more familiar with it, following the times given in your recipes as a guide.

**If you think your new oven is too hot or too cold, you can adjust the thermostat yourself.** If you think it is too hot, adjust the thermostat to make it cooler. If you think it is too cool, adjust the thermostat to make it hotter.

**We do not recommend the use of inexpensive thermometers,** such as those found in grocery stores, to check the temperature setting of your new oven. These thermometers may vary 20–40 degrees.

### To Adjust the Thermostat:

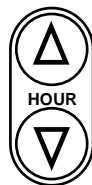

1. Put the Oven Temperature knob in the OFF position.
2. Press and hold the HOUR INCREASE and the HOUR DECREASE pads at the same time for 5 seconds until the display changes.
3. Immediately, before display changes back, press the HOUR INCREASE or DECREASE pads to increase or decrease the temperature in 5 degree increments.

The oven temperature can be increased up to 35°F hotter or decreased 35°F cooler.

If the oven adjustment is set cooler than the factory setting a minus sign “-” and the offset temperature will appear in the display.

4. Wait several seconds for the control to automatically set and return to its previous setting.

**NOTE:** This adjustment will not affect the broiling or self-cleaning temperatures. The adjustment will be retained in memory after a power failure.



# ROASTING



**Do not lock the oven door with the latch during roasting. The latch is used for self-cleaning only.**

Roasting is cooking by dry heat. Tender meat or poultry can be roasted uncovered in your oven. Roasting temperatures, which should be low and steady, keep spattering to a minimum.

Roasting is really a baking procedure used for meats. Therefore, oven controls are set for Baking or Timed Baking. (You may hear a slight clicking sound indicating the oven is working properly.) Timed Baking will turn the oven on and off automatically.

Most meats continue to cook after being removed from the oven. The internal temperature will rise 5° to 10°F. during the recommended standing time of 10 to 20 minutes. This allows roasts to firm up and makes them easier to carve. To compensate for this rise in temperature, you may want to remove the roast sooner (at 5° to 10°F. less than the temperature in the Roasting Guide).

Remember that food will continue to cook in the hot oven and therefore should be removed when the desired internal temperature has been reached.

## How to Set Your Range for Roasting

1. Place the shelf in A or B position.  
No preheating is necessary.

2. Check the weight of the meat. Place it, fat side up, or for poultry, breast-side-up, on the roasting grid in a shallow pan. The melting fat will baste the meat.

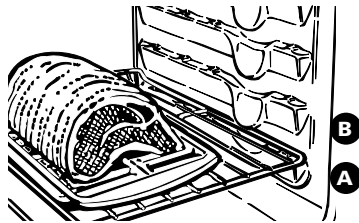

Select a pan as close to the size of the meat as possible. (The broiler pan with grid is a good pan for this.)

3. Turn the Oven Temperature knob to the desired setting.
4. After roasting is complete, turn the Oven Temperature knob to OFF and then remove the food from the oven.

## Use of Aluminum Foil

You can use aluminum foil to line the broiler pan. This makes clean-up easier when using the pan for marinating, cooking with fruits, cooking heavily cured meats or basting food during cooking. Press the foil tightly around the inside of the pan.



*(continued next page)*



# ROASTING

(continued)

## Questions and Answers

**Q. Is it necessary to check for doneness with a meat thermometer?**

**A.** Checking the finished internal temperature at the completion of cooking time is recommended. Temperatures are shown in the Roasting Guide. For roasts over 8 lbs., check with thermometer at half-hour intervals after half the cooking time has passed.

**Q. Why is my roast crumbling when I try to carve it?**

**A.** Roasts are easier to slice if allowed to cool 10 to 20 minutes after removing them from the oven. Be sure to cut across the grain of the meat.

**Q. Do I need to preheat my oven each time I cook a roast or poultry?**

**A.** It is not necessary to preheat your oven.

**Q. When buying a roast, are there any special tips that would help me cook it more evenly?**

**A.** Yes. Buy a roast as even in thickness as possible, or buy rolled roasts.

**Q. Can I seal the sides of my foil "tent" when roasting a turkey?**

**A.** Sealing the foil will steam the meat. Leaving it unsealed allows the air to circulate and brown the meat.

## ROASTING GUIDE

### Frozen Roasts

Frozen roasts of beef, pork, lamb, etc., can be started without thawing, but allow 10 to 25 minutes per pound additional time (10 minutes per pound for roasts under 5 pounds, more time for larger roasts).

Make sure poultry is thawed before roasting. Unthawed poultry often does not cook evenly. Some commercial frozen poultry can be cooked successfully without thawing. Follow the directions given on the package label.

Type	Oven Temperature	Doneness	Approximate Roasting Time in Minutes per Pound		Internal Temperature °F.
<b>Meat</b>			<b>3 to 5 lbs.</b>	<b>6 to 8 lbs.</b>	
Tender cuts; rib, high quality sirloin tip, rump or top round*	325°	Rare: Medium: Well Done:	24-33 35-39 40-45	18-22 22-29 30-35	140°-150°† 150°-160° 170°-185°
Lamb leg or bone-in shoulder*	325°	Rare: Medium: Well Done:	21-25 25-30 30-35	20-23 24-28 28-33	140°-150°† 150°-160° 170°-185°
Veal shoulder, leg or loin*	325°	Well Done:	35-45	30-40	170°-180°
Pork loin, rib or shoulder*	325°	Well Done:	35-45	30-40	170°-180°
Ham, precooked	325°	To Warm:	17-20 minutes per pound (any weight)		115°-120°
<b>Poultry</b>			<b>3 to 5 lbs.</b>	<b>Over 5 lbs.</b>	
Chicken or Duck	325°	Well Done:	35-40	30-35	185°-190°
Chicken pieces	350°	Well Done:	35-40		185°-190°
Turkey	325°	Well Done:	<b>10 to 15 lbs.</b> 18-25	<b>Over 15 lbs.</b> 15-20	<b>In thigh:</b> 185°-190°

\*For boneless rolled roasts over 6 inches thick, add 5 to 10 minutes per pound to times given above.

†The U. S. Department of Agriculture says "Rare beef is popular, but you should know that cooking it to only 140°F. means some food poisoning organisms may survive." (Source: *Safe Food Book. Your Kitchen Guide.* USDA Rev. June 1985.)

# BROILING

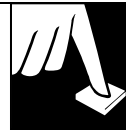

**Do not lock the oven door with the latch while broiling. The latch is used for self-cleaning only.**

Broiling is cooking food by intense radiant heat from the upper broil element in the oven. Most fish and tender cuts of meat can be broiled. Follow these directions to keep spattering and smoking to a minimum.

Turn the food using tongs only once during broiling. Time the foods for the first side according to the Broiling Guide. Turn the food, then use the times given for the second side as a guide to the preferred doneness.

## How to Set Your Range for Broiling

1. If the meat has fat or gristle around the edge, cut vertical slashes through both about 2 inches apart. If desired, the fat may be trimmed, leaving a layer about 1/8 inch thick.
2. Place the meat on the broiler grid in the broiler pan. Always use the grid so the fat drips into the broiler pan; otherwise the juices may become hot enough to catch on fire.
3. Position a shelf on the recommended shelf position as suggested in the Broiling Guide. Most broiling is done on C position, **but if your range is connected to 208 volts, you may wish to use a higher position.**
4. **Leave the door open to the broil stop position.** The door stays open by itself, yet the proper temperature is maintained in the oven.
5. Turn the Oven Temperature knob to BROIL. Preheating the elements is not necessary. (See the Comments in the Broiling Guide.)
6. When broiling is finished, turn the Oven Temperature knob to OFF. Serve the food immediately, and leave the pan outside the oven to cool during the meal for easiest cleaning.

## Use of Aluminum Foil

You can use aluminum foil to line your broiler pan and broiler grid. However, you must mold the foil tightly to the grid and cut slits in it just like the grid.

Without the slits, the foil will prevent fat and meat juices from draining into the broiler pan. The juices could become hot enough to catch on fire. If you do not cut the slits, you are frying, not broiling.

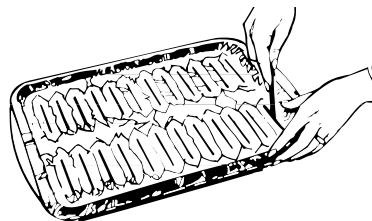

## Questions and Answers

- Q. When broiling, is it necessary to always use a grid in the pan?**
- A.** Yes. Using the grid suspends the meat over the pan. As the meat cooks, the juices fall into the pan, thus keeping meat drier. Juices are protected by the grid and stay cooler, thus preventing excessive spatter and smoking.
- Q. Should I salt the meat before broiling?**
- A.** No. Salt draws out the juices and allows them to evaporate. Always salt after cooking. Piercing the meat with a fork also allows juices to escape. Turn the meat with tongs instead of a fork.
- Q. Why are my meats not turning out as brown as they should?**
- A.** In some areas, the power (voltage) to the range may be low. In these cases, preheat the broil element for 10 minutes before placing the broiler pan with food in the oven. Check to see if you are using the recommended shelf position. Broil for the longest period of time indicated in the Broiling Guide. Turn the food only once during broiling. You may need to move the food to a higher shelf position.

*(continued next page)*



# BROILING GUIDE

- Always use the broiler pan and grid that comes with your oven. It is designed to minimize smoking and spattering by trapping juices in the shielded lower part of the pan.
- **The oven door should be open to the broil stop position.**
- For steaks and chops, slash fat evenly around the outside edges of the meat. To slash, cut crosswise through the outer fat surface just to the edge of the meat. Use tongs to turn meat over to prevent piercing the meat and losing juices.
- If desired, marinate meats or chicken before broiling, or brush with barbecue sauce last 5 to 10 minutes only.
- When arranging food on the pan, do not let fatty edges hang over the sides because dripping fat will soil the oven.
- The broiler does not need to be preheated. However, for very thin foods, or to increase browning, preheat if desired.
- Frozen steaks can be broiled by positioning the oven shelf at next lowest shelf position and increasing cooking times given in this guide 1½ times per side.
- **If your range is connected to 208 volts**, rare steaks may be broiled by preheating the broiler and positioning the oven shelf one position higher.

Food	Quantity and/or Thickness	Shelf Position	First Side Time, Minutes	Second Side Time, Minutes	Comments
<b>Bacon</b>	1/2 lb. (about 8 thin slices)	C	4½	4½	Arrange in single layer.
<b>Ground Beef</b> Well Done	1 lb. (4 patties) 1/2 to 3/4 inch thick	C	10	7	Space evenly. Up to 8 patties take about same time.
<b>Beef Steaks</b> Rare Medium Well Done	1 inch thick (1 to 1½ lbs.)	C C C	6 8 12	5 6 11	Steaks less than 1 inch thick cook through before browning. Pan frying is recommended.
Rare Medium Well Done	1½ inch thick (2 to 2½ lbs.)	C C C	10 15 25	7-8 14-16 20-25	Slash fat.
<b>Chicken</b>	1 whole (2 to 2½ lbs.), split lengthwise	A	35	10-15	Reduce time about 5 to 10 minutes per side for cut-up chicken. Brush each side with melted butter. Broil skin-side-down first.
<b>Bakery Products</b> Bread (Toast) or Toaster Pastries English Muffins	2 to 4 slices 1 pkg. (2) 2 (split)	C or D C or D	1½-2	1/2 3-4	Space evenly. Place English muffins cut-side-up and brush with butter, if desired.
<b>Lobster Tails</b>	2-4 (6 to 8 oz. each)	B	13-16	Do not turn over.	Cut through back of shell. Spread open. Brush with melted butter before broiling and after half of broiling time.
<b>Fish</b>	1-lb. fillets 1/4 to 1/2 inch thick	C	5	5	Handle and turn very carefully. Brush with lemon butter before and during cooking, if desired. Preheat broiler to increase browning.
<b>Ham Slices</b> (precooked)	1 inch thick	B	8	8	Increase time 5 to 10 minutes per side for 1½ inch thick or home cured ham.
<b>Pork Chops</b> Well Done	2 (1/2 inch thick) 2 (1 inch thick), about 1 lb.	C B	10 13	10 13	Slash fat.
<b>Lamb Chops</b> Medium Well Done	2 (1 inch thick), about 10 to 12 oz.	C C	10 12	9 10	Slash fat.
Medium Well Done	2 (1½ inch thick), about 1 lb.	C B	14 17	12 12-14	
<b>Wieners and similar precooked sausages, bratwurst</b>	1-lb. pkg. (10)	C	6	1-2	If desired, split sausages in half lengthwise; cut into 5- to 6-inch pieces.

# OPERATING THE SELF-CLEANING OVEN

Normal Cleaning Time is 4 hours 20 minutes



## Before a Clean Cycle

We recommend venting with an open window or using a ventilation fan or hood during the first self-clean cycle.

1. Remove the broiler pan, broiler grid, all cookware and any aluminum foil from the oven—they can't withstand the high cleaning temperatures.

**NOTE: The oven shelves may be cleaned in the self-cleaning oven.** However, they will darken, lose their luster and become hard to slide. Wipe the shelf supports with cooking oil after self-cleaning to make shelves slide more easily.

2. Wipe up heavy soil on the oven bottom. If you use soap, rinse thoroughly before self-cleaning to prevent staining.

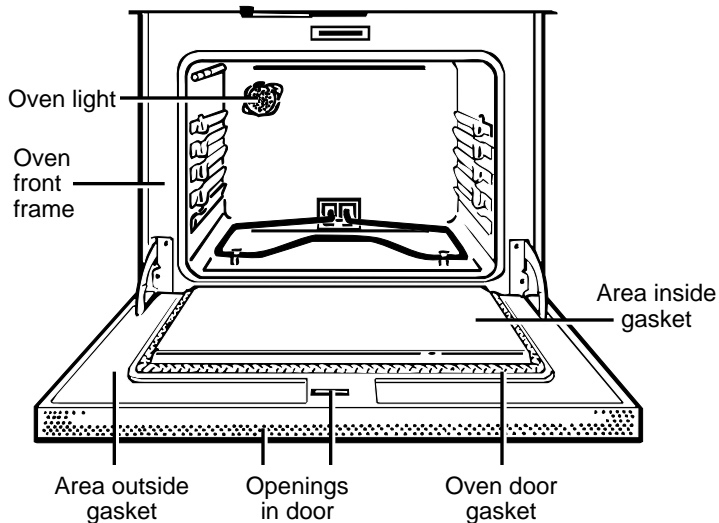

3. Clean spatters or soil on the oven front frame and the oven door outside the gasket with a dampened cloth. The oven front frame and the oven door outside the gasket do not get cleaned by the self-clean cycle. On these areas, use detergent and hot water or a soap-filled steel wool pad. Rinse well with a vinegar and water solution. This will help prevent a brown residue from forming when the oven is heated. Buff these areas with a dry cloth. Do not clean the gasket.

**Do not use abrasives or oven cleaners.** Clean the top, sides and outside front of the oven door with soap and water.

Make sure the oven light bulb cover is in place.

**Do not rub or clean the door gasket**—the fiberglass material of the gasket has an extremely low resistance to abrasion. An intact and well-fitting oven door gasket is essential for energy-efficient oven operation and good baking results. If you notice the gasket becoming worn, frayed or damaged in any way or if it has become displaced on the door, you should have it replaced.

**Do not let water run down through openings in the top of the door.** To help prevent water from getting in these slots when cleaning, open the door as far as it will go.

4. Close the oven door and make sure the oven light is off. If the oven light is not turned off, the life of the bulb will be shortened or it may burn out immediately.

**Do not use commercial oven cleaners or oven protectors in or near the self-cleaning oven.** A combination of any of these products plus the high clean-cycle temperature may damage the porcelain finish of the oven.

### Important:

The oven door must be closed and all controls must be set correctly for the cycle to work properly.

*(continued next page)*



# OPERATING THE SELF-CLEANING OVEN

(continued)

## How to Set the Oven for Cleaning

### Easy Steps:

1. Latch the door.
2. Turn the Oven Temperature knob to AUTO SELF CLEAN.

If the oven is too hot and you start to set a clean cycle, you will not be able to slide the latch.

Allow additional time for cooling before you try to set the cycle.

1. Follow directions in the Before a Clean Cycle section.

2. After closing the door, slide the latch handle to the right as far as it will go.

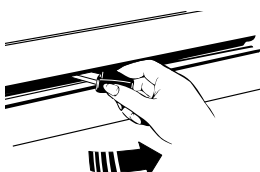

**Never force the latch handle. Forcing the handle will damage the door lock mechanism.**

3. Turn the Oven Temperature knob to AUTO SELF CLEAN. The AUTO SELF CLEAN light will glow.

**NOTE:** If you turn the Oven Temperature knob before you slide the latch, the AUTO SELF CLEAN light will flash. Slide the latch to the right.

**Clean cycle time is normally 4 hours and 20 minutes.** You can change the clean time to any time between 3 hours and 5 hours and 59 minutes, depending on how soiled your oven is.

**You have 1 minute to change your clean time.**

Use the HOUR and MIN. pads to change the total clean time.

Both the OVEN ON and AUTO SELF CLEAN lights will flash when the Clean Time is finished. Slide the latch handle to the left as far as it will go, turn the Oven Temperature knob to OFF and open the door.

**Never force the latch handle.** Wait until the AUTO SELF CLEAN light flashes and the latch slides easily. Forcing the latch handle may damage the door lock.

## To Stop A Clean Cycle

1. Turn the Oven Temperature knob to OFF.
2. Wait until the oven has cooled (approximately 1 hour) below the locking temperature to unlatch the door. You will not be able to open the door right away unless the oven has cooled below the locking temperature.

## After a Clean Cycle

**You may notice some white ash in the oven.** Just wipe it up with a damp cloth after the oven cools.

**If white spots remain,** remove them with a soap-filled steel wool pad. Be sure to rinse thoroughly with a vinegar and water mixture. These deposits are usually a salt residue that cannot be removed by the Clean Cycle.

**If the oven is not clean after one Clean Cycle,** repeat the cycle.

### NOTE:

- You cannot program the oven for Timed Baking before the door automatically unlocks.
- While the oven is self-cleaning, you can press the CLOCK pad to display the time of day. To return to the clean count down, press the COOK TIME pad.
- If the shelves become hard to slide, wipe the shelf supports with cooking oil.

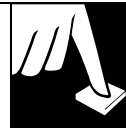

## How to Set Delay Start of Cleaning

### Easy Steps:

1. Latch the door.
2. Turn the Oven Temperature Control knob to AUTO SELF CLEAN.
3. Press the START TIME pad.
4. Press the HOUR and MIN. pads to set the time of day you want cleaning to start. The Self-Clean Cycle will automatically begin at the time you selected.

Delay Start is setting the oven control to start the clean cycle automatically at a later time than the present time of day.

**For example:** Let's say it is 7:00 and you want the oven to begin self-cleaning at 9:00 after you're finished in the kitchen. The oven is just soiled a normal amount so the normal Clean Time of 4 hours and 20 minutes is preferred.

1. Follow the directions in the Before a Clean Cycle section.

2. After closing the door, slide the latch handle to the right as far as it will go.

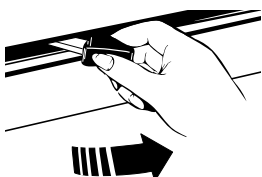

**Never force the latch handle. Forcing the handle will damage the door lock mechanism.**

3. Turn the Oven Temperature knob to the AUTO SELF CLEAN position.



4. Press the START TIME pad.



5. Press the HOUR pad until 9:00 appears in the display. The oven control is now set to start cleaning in 2 hours, at 9:00.

The Self-Clean Cycle will be set to automatically begin at 9:00 and finish at 1:20.

6. Both the OVEN ON light and the AUTO SELF CLEAN light will flash when the Clean Time is finished. Slide the latch handle to the left as far as it will go, turn the Oven Temperature knob to OFF and open the door.

**Never force the latch handle.** Wait until the AUTO SELF CLEAN light flashes and the latch slides easily. Forcing the latch handle may damage the door lock.

*(continued next page)*



# OPERATING THE SELF-CLEANING OVEN

(continued)

## Questions and Answers

**Q. Can I use commercial oven cleaners on any part of my self-cleaning oven?**

A. No cleaners or coatings should be used around any part of this oven. If you do use them and do not thoroughly rinse the oven with water, wiping it absolutely clean afterwards, the residue can scar the oven surface and damage metal parts the next time the oven is automatically cleaned.

**Q. What should I do if excessive smoking occurs during cleaning?**

A. This is caused by excessive soil. Turn the Oven Temperature knob to OFF. Open windows to rid room of smoke. Wait until the AUTO SELF CLEAN light goes off. Wipe up the excess soil and reset the clean cycle.

**Q. Is the “crackling” or “popping” sound I hear during cleaning normal?**

A. Yes. This is the sound of the metal heating and cooling during both the cooking and cleaning functions.

**Q. Should there be any odor during the cleaning?**

A. Yes, there will be an odor during the first few cleanings. Failure to wipe out excessive soil might also cause a strong odor when cleaning.

**Q. What causes the hair-like lines on the enameled surface of my oven?**

A. This is a normal condition, resulting from heating and cooling during cleaning. These lines do not affect how your oven performs.

**Q. Why do I have ash left in my oven after cleaning?**

A. Some types of soil will leave a deposit which is ash. It can be removed with a damp sponge or cloth.

**Q. My oven shelves do not slide easily. What is the matter?**

A. After many cleanings, oven shelves will lose their luster and become hard to slide. To make shelves slide more easily, wipe the shelf supports with cooking oil.

**Q. My oven shelves have become gray after the self-clean cycle. Is this normal?**

A. Yes. After the self-clean cycle, the shelves will lose some luster and discolor to a deep gray color.

**Q. Can I cook food on the cooktop while the oven is self-cleaning?**

A. Yes. While the oven is self-cleaning, you can use the cooktop just as you normally do.

**Q. The AUTO SELF CLEAN light flashes when I set the clean cycle. What's wrong?**

A. The AUTO SELF CLEAN light will flash until the latch is moved to the right.



# CARE AND CLEANING



## BE SURE ELECTRICAL POWER IS OFF AND ALL SURFACES ARE COOL BEFORE CLEANING ANY PART OF THE RANGE.

Proper care and cleaning are important so your radiant cooktop will give you efficient and satisfactory service. If soil, mineral deposits from evaporated water spills or metal rub-off from aluminum cookware is not removed, it will burn on the glass cooktop surface and cause permanent discoloration.

Follow these directions carefully in caring for your cooktop to assure safe and proper maintenance.

**Be sure that the surface unit control knobs are turned off and that the entire cooktop is cool before cleaning.** Do not use a cooktop cleaner on a hot cooktop. The fumes can be hazardous to your health and can chemically attack the glass surface.

## Control Panel and Knobs

**It's a good idea to wipe the control panel after each use.** Clean with mild soap and water or vinegar and water, rinse with clean water and polish dry with a soft cloth.

**Do not use abrasive cleansers, strong liquid cleansers, plastic scouring pads or oven cleansers on the control panel**—they will damage the finish. A 50/50 solution of vinegar and hot water solution works well.

**The control knobs may be removed for easier cleaning.**

**Before removing the knobs for cleaning,** please note that the knobs on the left side and the knobs on the right side are in the proper OFF position. When replacing the knobs, check the OFF position to insure proper placement.

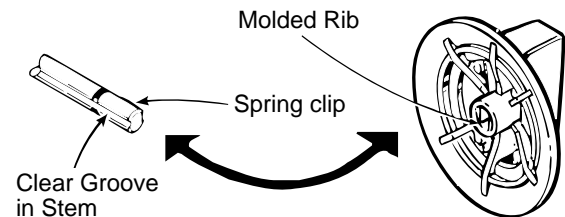

The knob stem has a groove in each side. The groove on one side has a spring clip. The other groove is clear (see illustration). Check the inside of the knob and find the molded rib.

**Wash the knobs** in soap and water or a vinegar and hot water solution but do not soak.

Replace the knob by fitting the molded rib inside the knob into the clear groove on the stem.

## Oven Shelves

**Clean the shelves with a mild abrasive cleanser or steel wool.** After cleaning, rinse the shelves with clean water and dry with a clean cloth.

**NOTE: The oven shelves may also be cleaned in the self-cleaning oven.** However, the shelves will darken, lose their luster and become hard to slide. Wipe the shelf supports with cooking oil after self-cleaning to make the shelves slide more easily.

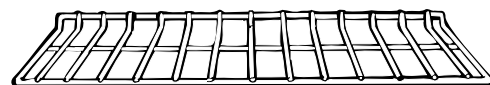

## Oven Heating Elements

**Do not clean the bake element or the broil element.** Any soil will burn off when the elements are heated.

The bake element can be lifted gently to clean the oven floor. If spillovers, residue or ash accumulate around the bake element gently wipe around the element with warm water.

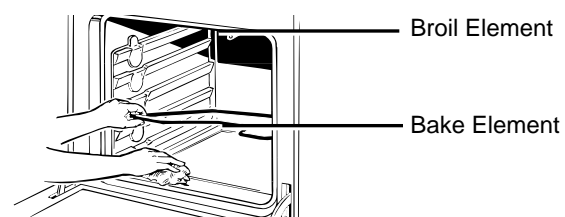

(continued next page)



# CARE AND CLEANING

(continued)

## Broiler Pan and Grid

**After broiling**, remove the broiler pan from the oven. Remove the grid from the pan. Carefully pour out grease from the pan into a proper container. Wash and rinse the broiler pan and grid in hot water with a soap-filled or plastic scouring pad.

**If food has burned on**, sprinkle the grid with detergent while hot and cover with wet paper towels or a dishcloth. Soaking the pan will remove burned on foods.

Both the broiler pan and grid may be cleaned with a commercial oven cleaner.



Both the broiler pan and grid can also be cleaned in the dishwasher.

Do not clean the broiler pan or grid in the self-cleaning oven.

Do not store a soiled broiler pan and grid anywhere in the range.

## Lift-Off Oven Door

**The oven door is removable**, but it is heavy. You may need help removing and replacing the door. Do not lift the door by the handle. This can cause the glass to break or can cause damage to the door.

**To remove the door**, open it a few inches to the special stop position that will hold the door open. Grasp firmly on each side and lift the door straight up and off the hinges.

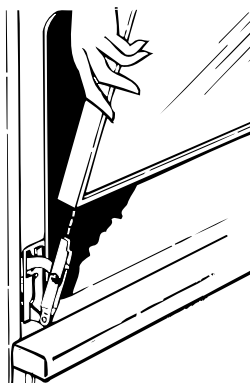

### NOTE:

- Be careful not to place hands between the hinge and the oven door frame as the hinge could snap back and pinch fingers.
- While working in the oven area, cover the hinges with towels or empty paper towel rolls to prevent pinched fingers and chipping the porcelain enamel on the frame.

**To replace the door**, make sure the hinges are in the special stop position. Position the slots in the bottom of the door squarely over the hinges. Then lower the door slowly and evenly over both hinges at the same time. If hinges snap back against the oven frame, pull them back out.

### TO CLEAN THE DOOR:

#### Inside of the door:

- Because the area inside the gasket is cleaned during the self clean cycle, you do not need to clean this by hand. Any soap left on the liner causes additional stains when the oven is heated.
- The area outside the gasket can be cleaned with a soap filled scouring pad.
- Do not rub or clean the door gasket—the fiberglass material of the gasket has an extremely low resistance to abrasion. An intact and well-fitting oven door gasket is essential for energy-efficient oven operation and good baking results. If you notice the gasket becoming worn, frayed or damaged in any way or if it has become displaced on the door, you should have it replaced.

**NOTE:** The gasket is designed with a gap at the bottom to allow for proper air circulation.

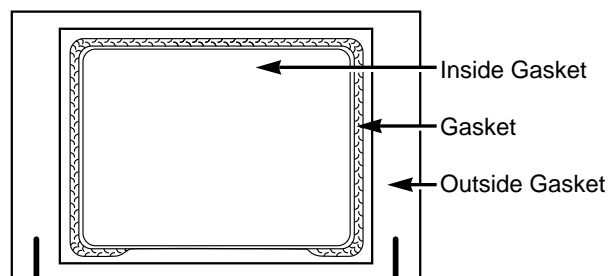

#### Outside of the door:

- Use soap and water to thoroughly clean the top, sides and front of the oven door. Rinse well.
- Spillage of marinades, fruit juices, tomato sauces and basting materials containing acids may cause discoloration and should be wiped up immediately. When surface is cool, clean and rinse.
- Do not use oven cleaners, cleansing powders or harsh abrasives on the outside of the door.

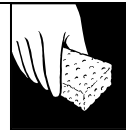

## Removable Storage Drawer

The storage drawer is a good place to store cookware and bakeware. Do not store plastics and flammable material in the drawer.

Do not overload the storage drawer. If the drawer is too heavy, it may slip off the track when opened. To open the drawer, grasp the center of the handle and pull straight out.

The storage drawer may be removed for cleaning under the range.

### To remove:

- Pull the drawer straight out and lift over the guide stops.

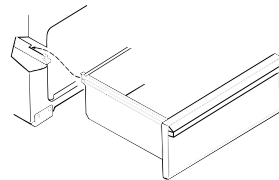

### To replace:

- Lift over the guide stops and slide the drawer into place.

### To clean the inside and outside:

- Wash with soap and water. Rinse well. Do not use cleansings powders or harsh abrasives which may scratch the surface.

## Oven Interior Light

**NOTE:** The glass cover should be removed only when cold. Wearing latex gloves may offer a better grip.

The light bulb is located on the back wall of the oven. Before replacing the bulb, disconnect electrical power to the range at the main fuse or circuit breaker panel or unplug the range from the electrical outlet. Let the bulb cool completely before removing it. For your safety, do not touch a hot bulb with a damp cloth. If you do, the bulb will break.

### To remove:

Unscrew the cover and remove the bulb.

### To replace:

Put in a new 40-watt appliance bulb.

### NOTE:

- A 40-watt appliance bulb is smaller than a standard 40-watt household bulb.
- Install and tighten the cover.
- Reconnect electrical power to the range.

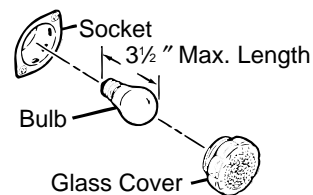

## Painted Surfaces

Painted surfaces include the outside oven door, sides, control panel and drawer front. Clean these with soap and water or a vinegar and water solution. **Do not use commercial oven cleaners, cleansings powders, steel wool or harsh abrasives on any painted surface.**

## Oven Vent Duct

The oven vent is located at the rear of the cooktop. Never cover the opening with aluminum foil or any other material. This would prevent the oven vent from working properly.

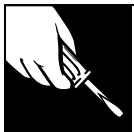

# ANTI-TIP DEVICE

## WARNING

- All ranges can tip.
- Injury could result.
- Install the Anti-tip device packed with the range.
- See the Installation Instructions.



## STABILITY DEVICE INSTALLATION INSTRUCTIONS FOR BRACKET KIT NO. 342473

### Tools needed:

- Phillips head screwdriver
- 1 3/8" open end or adjustable wrench

The bracket attaches to floor or wall to hold either the right or left rear leg leveler. If fastening to the floor, be sure that the screws do not penetrate electrical wiring or plumbing. If this cannot be determined, use shorter screws that will not penetrate through flooring.

The bracket is packed inside the oven. Remove and follow the instructions below.

1. Decide whether the bracket will be installed on the right or left side of the range location.
2. If the bracket side of the range is adjacent to a cabinet, place the bracket against back wall and cabinet as shown in Figure 1.

If there is no adjacent cabinet, determine where the location of the range side (painted outside panel) will be. Place the bracket with its outside edge at this location and against the back wall. See Figure 1.

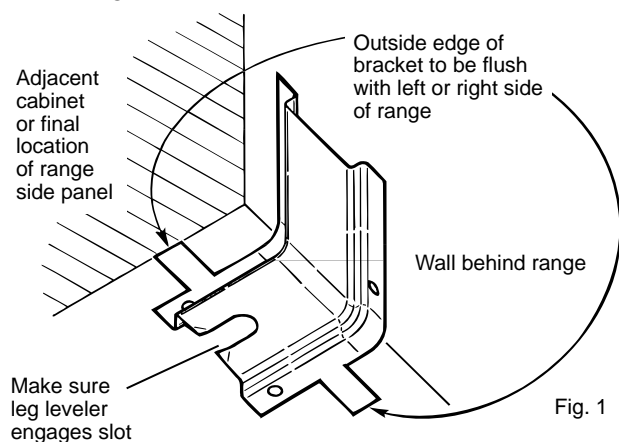

3. Determine whether you will anchor the bracket to the floor or wall. Fasten the bracket securely with the screws provided. The screws are self-drilling in wood, plywood, particle and chip board, and most metal framing. If attaching to masonry you can buy suitable screws and anchors at hardware stores. Use a masonry drill to drill the required holes.
4. Using the wrench, back out the four leg levelers at least two turns. See the Installation Instructions for more leveling information before positioning range.
5. Slide the range into place. Be sure the rear leg leveler fully engages the slot in the bracket. If the range cannot be moved back far enough for the rear leg leveler to enter the bracket, move the bracket forward as required and attach to the floor in the new location.

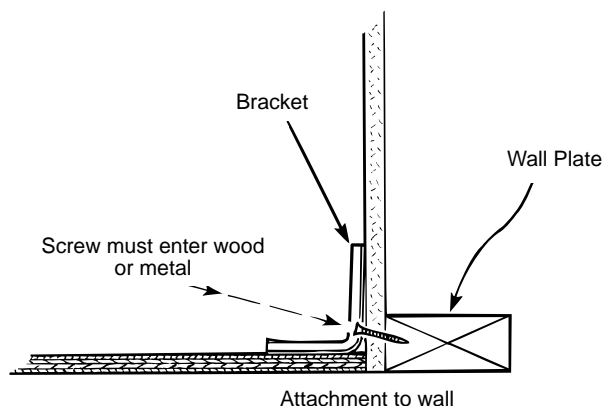

# QUESTIONS? USE THIS PROBLEM SOLVER



PROBLEM	POSSIBLE CAUSE
“F-AND A NUMBER” FLASH IN THE DISPLAY	<ul style="list-style-type: none"> <li>• If the time display flashes “F-and a number”, you have function error code. If a function error code appears during the self-cleaning cycle, check the oven door latch. The latch may have been moved, even if only slightly, from the latched position. Make sure the latch is moved to the right as far as it will go. Turn the Oven Temperature knob to OFF. Allow the oven to cool for one hour. Put the oven back into operation.</li> <li>• Disconnect all power to the range for 5 minutes and then reconnect power. If the failure code repeats, then call for service.</li> </ul>
SURFACE UNITS WILL NOT MAINTAIN A ROLLING BOIL OR FRYING RATE IS NOT FAST ENOUGH	<ul style="list-style-type: none"> <li>• You must use pans which are absolutely flat. If light can be seen between the pan bottom and a straight edge, the elements will not transfer heat properly.</li> <li>• Pan bottoms should closely match the diameter of the surface unit selected.</li> </ul>
COOKTOP FEELS HOT	<ul style="list-style-type: none"> <li>• The glass cooktop surfaces may seem hotter than you are used to. This is normal. <b>Make sure flat-bottomed pans are used.</b></li> </ul>
FOODS COOK SLOWLY	<ul style="list-style-type: none"> <li>• Improper cookware being used. Pan bottoms should be flat, fairly heavy-weight and the same diameter as the surface unit selected.</li> </ul>
SURFACE UNITS DO NOT WORK PROPERLY	<ul style="list-style-type: none"> <li>• Difficulty may be in the main distribution panel of your house, caused by a blown oven-circuit fuse, a tripped oven-circuit breaker, the main fuse or the main circuit breaker, depending on the nature of the power supply. If a circuit breaker is involved, reset it. If the control box uses fuses, the oven fuse (a cartridge-type) should be changed, <b>BUT ONLY BY SOMEONE FAMILIAR WITH ELECTRICAL CIRCUITS.</b> If after performing one of these procedures, the fuse blows or circuit breaker trips again, call for service. <b>NOTE:</b> Apartment tenants or condominium owners should ask their building management to perform this check before calling for service.</li> <li>• Cooktop surface unit controls are not properly set, or the wrong control knob is set for the surface unit you are using.</li> </ul>
TINY SCRATCHES (may appear as cracks) OR ABRASIONS ON RADIANT COOKTOP GLASS SURFACE	<ul style="list-style-type: none"> <li>• Incorrect cleaning methods have been used, cookware with rough bottoms has been used, or coarse particles (salt or sand) were between the cookware and the surface of cooktop. Use recommended cleaning procedures, be sure cookware bottoms and cookware are clean before use and use cookware with smooth bottoms. Tiny scratches are not removable but will become less visible in time as a result of cleaning.</li> </ul>
METAL MARKINGS (may appear as scratches)	<ul style="list-style-type: none"> <li>• Do not slide aluminum cookware across the surface. Use recommended cleaning procedure to remove marks.</li> <li>• Incorrect cleaning materials have been used, encrusted boilovers or grease spatters remain on the surface. Use a razor scraper and recommended cleaning procedure.</li> </ul>
DARK STREAKS OR SPECKS	<ul style="list-style-type: none"> <li>• Use a razor scraper and recommended cleaning procedure.</li> </ul>
AREAS OF DISCOLORATION ON COOKTOP	<ul style="list-style-type: none"> <li>• Marks from aluminum and copper pans as well as mineral deposits from water or food can be removed with Cook Top Cleaning Creme.</li> </ul>
HOT SUGAR MIXTURES/ PLASTIC MELTED TO THE SURFACE	<ul style="list-style-type: none"> <li>• See the Glass Ceramic Cooktop Cleaning section.</li> </ul>
FREQUENT CYCLING OFF AND ON OF SURFACE UNITS	<ul style="list-style-type: none"> <li>• Incorrect cookware used. Use only flat cookware to minimize cycling.</li> </ul>
THE DISPLAY GOES BLANK OR INDICATOR LIGHTS COME ON WHEN THE RANGE IS NOT IN USE	<ul style="list-style-type: none"> <li>• Disconnect power to the range at the fuse box or circuit breaker for at least 10 seconds. Turn power on and power up your range. If the indicator lights are still on, call for service.</li> </ul>
OVEN LIGHT DOES NOT WORK	<ul style="list-style-type: none"> <li>• Light bulb is loose or defective. Tighten or replace.</li> <li>• Switch operating oven light is broken. Call for service.</li> </ul>

*(continued next page)*



# THE PROBLEM SOLVER

(continued)

PROBLEM	POSSIBLE CAUSE
OVEN WILL NOT WORK	<ul style="list-style-type: none"><li>• Plug on range is not completely inserted in the electrical outlet.</li><li>• The circuit breaker in your house has been tripped, or a fuse has been blown.</li><li>• Oven controls not properly set.</li><li>• Door left in locked position after cleaning.</li></ul>
FOOD DOES NOT BROIL PROPERLY	<ul style="list-style-type: none"><li>• The Oven Temperature knob not set at BROIL.</li><li>• Door not left open to the broil stop position as recommended.</li><li>• Improper shelf position being used. See the Broiling Guide.</li><li>• Food is being cooked on hot pan.</li><li>• Cookware is not suited for broiling.</li><li>• Low voltage. See the Broiling section.</li><li>• Aluminum foil used on the broil pan grid has not been fitted properly and slit as recommended.</li></ul>
FOOD DOES NOT ROAST OR BAKE PROPERLY	<ul style="list-style-type: none"><li>• The Oven Temperature knob not set correctly.</li><li>• Shelf position is incorrect. See the Roasting or Baking sections.</li><li>• Oven shelf not level.</li><li>• Incorrect cookware or cookware of improper size is being used.</li><li>• Oven thermostat needs adjustment. See the Adjust the Oven Thermostat—<i>Do It Yourself</i> section.</li></ul>
CLOCK AND TIMER DO NOT WORK	<ul style="list-style-type: none"><li>• Make sure the electrical plug is plugged into a live, properly grounded power outlet.</li><li>• Check for power outage.</li><li>• Review the Oven Control, Clock and Timer section of this guide.</li></ul>
OVEN WILL NOT SELF-CLEAN	<ul style="list-style-type: none"><li>• Oven temperature is too high to set self-clean operation. Allow the range to cool to room temperature and reset the controls.</li><li>• Oven Temperature knob not set to AUTO SELF CLEAN.</li><li>• Door latch handle not moved all the way to the right.</li></ul>
OVEN DOOR ACCIDENTALLY LOCKED DURING COOKING	<ul style="list-style-type: none"><li>• Turn the Oven Temperature knob to OFF. Allow the oven to cool. Never force the door latch handle.</li></ul>
OVEN DOOR WILL NOT UNLOCK	<ul style="list-style-type: none"><li>• Oven must cool below locking temperature.</li></ul>
OVEN NOT CLEAN AFTER CLEAN CYCLE	<ul style="list-style-type: none"><li>• Oven controls not set properly.</li><li>• Heavily soiled ovens may need to self-clean again or for a longer period.</li><li>• Heavy spillovers should be cleaned before starting clean cycle.</li></ul>
AUTO SELF CLEAN LIGHT FLASHES	<ul style="list-style-type: none"><li>• The Oven Temperature knob is set at AUTO SELF CLEAN before the door latch handle is moved to the right.</li></ul>
OVEN TEMPERATURE TOO HOT OR TOO COLD	<ul style="list-style-type: none"><li>• Oven thermostat needs adjustment. See the Adjust the Oven Thermostat—<i>Do It Yourself</i> section.</li></ul>
“BURNING” OR “OILY” ODOR EMITTING FROM OVEN WHEN TURNED ON	<ul style="list-style-type: none"><li>• This is normal in a new oven and will disappear in time. To speed the process, set a self-clean cycle for a minimum of 3 hours. See the Operating the Self-Cleaning Oven section.</li></ul>
STRONG ODOR	<ul style="list-style-type: none"><li>• An odor from the insulation around the inside of the oven is normal for the first few times the oven is used. This is temporary.</li></ul>

**If you need more help...call, toll free:**

**GE Answer Center®**

**800.626.2000**

**consumer information service**

# We'll Be There

With the purchase of your new Hotpoint appliance, receive the assurance that if you ever need information or assistance, we'll be there. All you have to do is call—toll-free!

## **GE Answer Center<sup>®</sup>** **800.626.2000**

Whatever your question about any Hotpoint major appliance, GE Answer Center<sup>®</sup> information service is available to help. Your call—and your question—will be answered promptly and courteously. And you can call any time. GE Answer Center<sup>®</sup> service is open 24 hours a day, 7 days a week.

## **In-Home Repair Service** **800-GE-CARES (800-432-2737)**

Our consumer service professional will provide expert repair service on your Hotpoint appliance, scheduled at a time that's convenient for you. Many GE Consumer Service company-operated locations offer you service today or tomorrow, or at your convenience (7:00 a.m. to 7:00 p.m. weekdays, 9:00 a.m. to 2:00 p.m. Saturdays). Our factory-trained technicians know your appliance inside and out—so most repairs can be handled in just one visit.

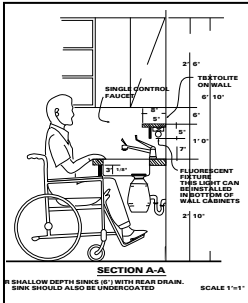

## **For Customers With Special Needs...** **800.626.2000**

Upon request, we will provide Braille controls for a variety of Hotpoint appliances, and a brochure to assist in planning a barrier-free kitchen for persons with limited mobility. To obtain these items, free of charge, call 800.626.2000.

Consumers with impaired hearing or speech who have access to a TDD or a conventional teletypewriter may call 800-TDD-GEAC (800-833-4322) to request information or service.

## **Service Contracts** **800-626-2224**

You can have the secure feeling that GE Consumer Service will still be there after your Hotpoint product warranty expires. Purchase a GE contract while your warranty is still in effect and you'll receive a substantial discount. With a multiple-year contract, you're assured of future service at today's prices.

## **Parts and Accessories** **800-626-2002**

Individuals qualified to service their own appliances can have parts or accessories sent directly to their home. Our parts system provides access to over 47,000 Genuine Renewal Parts...and all are fully warranted. VISA, MasterCard and Discover cards are accepted.

User maintenance instructions contained in this guide cover procedures intended to be performed by any user. Other servicing generally should be referred to qualified service personnel. Caution must be exercised, since improper servicing may cause unsafe operation.

# YOUR HOTPOINT ELECTRIC RANGE WARRANTY

Staple sales slip or cancelled check here. Proof of original purchase date is needed to obtain service under warranty.

## WHAT IS COVERED

### FULL ONE-YEAR WARRANTY

For one year from date of original purchase, we will provide, free of charge, parts and service labor in your home to repair or replace **any part of the range** that fails because of a manufacturing defect.

\*\*\*\*\*  
This warranty is extended to the original purchaser and any succeeding owner for products purchased for ordinary home use in the 48 mainland states, Hawaii and Washington, D.C. In Alaska the warranty is the same except that it is LIMITED because you must pay to ship the product to the service shop or for the service technician's travel costs to your home.

All warranty service will be provided by our Factory Service Centers or by our authorized Customer Care® servicers during normal working hours.

Should your appliance need service, during warranty period or beyond, call 800-GE-CARES (800-432-2737).

## WHAT IS NOT COVERED

- Service trips to your home to teach you how to use the product.

### Read your Use and Care material.

If you then have any questions about operating the product, please contact your dealer or our Consumer Affairs office at the address below, or call, toll free: GE Answer Center®  
800.626.2000  
consumer information service

- Improper installation.

If you have an installation problem, contact your dealer or installer. You are responsible for providing adequate electrical, gas, exhausting and other connecting facilities as described in the Installation Instructions provided with the product.

- Replacement of house fuses or resetting of circuit breakers.
- Damage to the Cooktop caused by use of cleaners other than the cooktop creme provided with the product.
- Damage to the cooktop caused by hardened spills of sugary materials or melted plastic that are not cleaned according to the directions in the Use and Care Guide.
- Damage to the product due to misuse or abuse.
- Failure of the product if it is used for other than its intended purpose or used commercially.
- Damage to product caused by accident, fire, floods or acts of God.

WARRANTOR IS NOT RESPONSIBLE FOR CONSEQUENTIAL DAMAGES.

Some states do not allow the exclusion or limitation of incidental or consequential damages, so the above limitation or exclusion may not apply to you. This warranty gives you specific legal rights, and you may also have other rights which vary from state to state. To know what your legal rights are in your state, consult your local or state consumer affairs office or your state's Attorney General.

**Warrantor: General Electric Company**

**If further help is needed concerning this warranty, write:  
Manager—Consumer Affairs, GE Appliances, Louisville, KY 40225**



Recycled Paper

Part No. 164D2966P215

Pub No. 39-4753

10-95 CG

# HOTPOINT

RB787

Printed in LaFayette, GA



## Free Manuals Download Website

<http://myh66.com>

<http://usermanuals.us>

<http://www.somanuals.com>

<http://www.4manuals.cc>

<http://www.manual-lib.com>

<http://www.404manual.com>

<http://www.luxmanual.com>

<http://aubethermostatmanual.com>

Golf course search by state

<http://golfingnear.com>

Email search by domain

<http://emailbydomain.com>

Auto manuals search

<http://auto.somanuals.com>

TV manuals search

<http://tv.somanuals.com>