



SA304X-8
electric oven

operating and installation instructions





SA304X-8
electric oven

operating and installation instructions



1. INSTRUCTIONS FOR USE	4
2. SAFETY PRECAUTIONS	6
3. ENVIRONMENTAL RESPONSIBILITY	8
4. GET TO KNOW YOUR OVEN	9
5. AVAILABLE ACCESSORIES	10
6. USING THE OVEN	15
7. COOKING WITH THE OVEN.....	26
8. CLEANING AND MAINTENANCE	35
9. EXTRAORDINARY MAINTENANCE	45
10. INSTALLING THE APPLIANCE	50



INSTRUCTIONS FOR THE USER: these contain user advice, description of the commands and the correct procedures for cleaning and maintenance of the appliance.



INSTRUCTIONS FOR THE INSTALLER: these instructions are intended for the qualified technician who must perform the installation, put it into operation and test the appliance.



1. INSTRUCTIONS FOR USE



THIS MANUAL IS AN INTEGRAL PART OF THE APPLIANCE. IT MUST BE KEPT IN ITS ENTIRETY AND IN AN ACCESSIBLE PLACE FOR THE WHOLE WORKING LIFE OF THE APPLIANCE.

CAREFUL READING OF THIS MANUAL AND ALL THE INSTRUCTIONS THEREIN BEFORE USING THE APPLIANCE IS ESSENTIAL. INSTALLATION MUST BE CARRIED OUT BY QUALIFIED PERSONNEL IN ACCORDANCE WITH THE REGULATIONS IN FORCE. THIS APPLIANCE IS INTENDED FOR HOUSEHOLD USE AND COMPLIES WITH THE EEC DIRECTIVES CURRENTLY IN FORCE. THE APPLIANCE HAS BEEN BUILT TO CARRY OUT THE FOLLOWING FUNCTIONS: COOKING FOOD; ALL OTHER USES ARE CONSIDERED UNSUITABLE.

THE MANUFACTURER CANNOT BE HELD LIABLE FOR USE OTHER THAN AS INDICATED.



IF THE APPLIANCE IS INSTALLED ON BOATS OR IN CARAVANS, DO NOT USE IT AS A ROOM HEATER.



DO NOT USE THIS APPLIANCE FOR HEATING ROOMS.



THIS APPLIANCE IS MARKED ACCORDING TO EUROPEAN DIRECTIVE 2002/96/EC ON WASTE ELECTRICAL AND ELECTRONIC EQUIPMENT (WEEE).

THIS DIRECTIVE DEFINES THE STANDARDS FOR THE COLLECTION AND RECYCLING OF WASTE ELECTRICAL AND ELECTRONIC EQUIPMENT APPLICABLE THROUGHOUT THE EUROPEAN UNION.



NEVER OBSTRUCT THE OPENINGS AND SLITS PROVIDED FOR VENTILATION AND HEAT DISPERSAL.



DO NOT REST ANY WEIGHT OR SIT ON THE OPEN DOOR OF THE APPLIANCE.



THE IDENTIFICATION PLATE WITH THE TECHNICAL DATA, SERIAL NUMBER AND BRAND NAME HAS BEEN VISIBLY AFFIXED TO THE APPLIANCE.

DO NOT REMOVE THIS PLATE FOR ANY REASON.



BEFORE THE APPLIANCE IS PUT INTO OPERATION, ALL THE PROTECTIVE FILMS APPLIED INSIDE OR OUTSIDE MUST BE REMOVED.



TAKE CARE THAT NO OBJECTS ARE STUCK IN THE DOOR OF THE OVEN.



THE APPLIANCE BECOMES VERY HOT INSIDE DURING USE. SUITABLE HEAT-PROOF GLOVES SHOULD BE WORN FOR ALL OPERATIONS.



General instructions

GB-IE



DO NOT USE STEEL SPONGES AND SHARP SCRAPERS AS THEY WILL DAMAGE THE SURFACE.

USE NORMAL NON-ABRASIVE PRODUCTS, INCLUDING WOODEN OR PLASTIC UTENSILS IF NECESSARY. RINSE THOROUGHLY AND DRY USING A SOFT CLOTH OR A MICROFIBRE CLOTH.

DO NOT ALLOW RESIDUES OF SUGARY FOODS (SUCH AS JAM) TO SET INSIDE THE OVEN. IF THEY ARE ALLOWED TO SET FOR TOO LONG, THEY COULD RUIN THE ENAMEL COVERING THE INSIDE OF THE OVEN.



DO NOT USE PLASTIC KITCHENWARE OR CONTAINERS. THE HIGH TEMPERATURES INSIDE THE OVEN COULD MELT THE PLASTIC, DAMAGING THE APPLIANCE.



DO NOT USE SEALED TINS OR CONTAINERS IN THE APPLIANCE. OVERPRESSURE MAY OCCUR INSIDE THE CONTAINERS DURING COOKING, CREATING A DANGER OF EXPLOSION.



DO NOT LEAVE THE APPLIANCE UNATTENDED DURING COOKING PROCESSES WHERE FATS OR OILS COULD BE RELEASED. FATS AND OILS MAY CATCH FIRE.



DO NOT COVER THE BOTTOM OF THE OVEN WITH ALUMINIUM OR TINFOIL SHEETS DURING COOKING AND DO NOT PLACE PANS OR TRAYS ON IT TO AVOID DAMAGE TO THE ENAMELLED SURFACE.



IF THE SURFACES ARE STILL VERY HOT DURING COOKING, DO NOT POUR WATER DIRECTLY ONTO THE TRAYS. THE STEAM COULD CAUSE SEVERE BURNS AND DAMAGE TO ENAMELLED SURFACES.



ALL COOKING OPERATIONS MUST TAKE PLACE WITH THE DOOR CLOSED.



2. SAFETY PRECAUTIONS

REFER TO THE INSTALLATION INSTRUCTIONS FOR THE SAFETY REGULATIONS FOR ELECTRIC OR GAS APPLIANCES AND VENTILATION FUNCTIONS.

IN YOUR INTERESTS AND FOR YOUR SAFETY THE LAW REQUIRES THAT THE INSTALLATION AND SERVICING OF ALL ELECTRICAL APPLIANCES IS CARRIED OUT BY QUALIFIED PERSONNEL IN ACCORDANCE WITH THE REGULATIONS IN FORCE.

OUR APPROVED INSTALLERS GUARANTEE A SATISFACTORY JOB.

GAS OR ELECTRICAL APPLIANCES MUST ALWAYS BE DISCONNECTED BY SUITABLY SKILLED PEOPLE.



BEFORE CONNECTING THE APPLIANCE TO THE POWER GRID, CHECK THE DATA ON THE PLATE AGAINST THE DATA FOR THE GRID ITSELF.



BEFORE CARRYING OUT INSTALLATION / MAINTENANCE WORK, MAKE SURE THAT THE APPLIANCE IS NOT CONNECTED TO THE POWER GRID.



THE PLUG TO BE CONNECTED TO THE POWER SUPPLY CABLE AND ITS SOCKET MUST BE OF THE SAME TYPE AND CONFORM TO THE REGULATIONS IN FORCE. THE SOCKET MUST BE ACCESSIBLE AFTER THE APPLIANCE HAS BEEN BUILT-IN. NEVER DISCONNECT THE PLUG BY PULLING ON THE CABLE.



IF THE POWER SUPPLY CABLE IS DAMAGED, CONTACT THE TECHNICAL SUPPORT SERVICE IMMEDIATELY AND THEY WILL REPLACE IT.



IT IS OBLIGATORY FOR ALL ELECTRICAL EQUIPMENT TO BE EARTHED ACCORDING TO THE METHODS LAID DOWN BY SAFETY REGULATIONS.



IMMEDIATELY AFTER INSTALLATION CARRY OUT A BRIEF INSPECTION TEST, FOLLOWING THE INSTRUCTIONS BELOW. SHOULD THE APPLIANCE NOT FUNCTION, DISCONNECT IT FROM THE ELECTRICITY SUPPLY AND CALL THE NEAREST TECHNICAL SUPPORT CENTRE. NEVER ATTEMPT TO REPAIR THE APPLIANCE.



NEVER PUT INFLAMMABLE OBJECTS IN THE OVEN: IF IT IS SWITCHED ON BY ACCIDENT, IT MAY CAUSE A FIRE.



DURING USE THE APPLIANCE BECOMES VERY HOT. TAKE CARE NOT TO TOUCH THE HEATING ELEMENTS INSIDE THE OVEN.



THIS APPLIANCE MAY NOT BE USED BY PEOPLE (INCLUDING CHILDREN) OF REDUCED PHYSICAL AND MENTAL CAPACITY, OR LACKING IN EXPERIENCE IN THE USE OF ELECTRICAL APPLIANCES, UNLESS THEY ARE SUPERVISED OR INSTRUCTED BY ADULTS RESPONSIBLE FOR THEIR SAFETY.



General instructions

GB-IE



DO NOT LET CHILDREN GO NEAR THE APPLIANCE WHEN IT IS IN OPERATION OR PLAY WITH IT AT ANY TIME.



DO NOT INSERT POINTED METAL OBJECTS (CUTLERY OR UTENSILS) INTO THE SLITS IN THE APPLIANCE.



IF THE APPLIANCE IS INSTALLED ON CARAVANS OR BOATS, IT MUST NOT BE USED TO HEAT ROOMS.



DO NOT USE STEAM JETS FOR CLEANING THE APPLIANCE. THE STEAM COULD REACH THE ELECTRONICS, DAMAGING THEM AND CAUSING SHORT-CIRCUITS.



DO NOT MODIFY THIS APPLIANCE.



DO NOT SPRAY ANY SPRAY PRODUCTS NEAR THE ELECTRICAL APPLIANCE WHILE IT IS IN OPERATION.
DO NOT USE SPRAY PRODUCTS WHILE THE PRODUCT IS STILL HOT.



The manufacturer cannot be held liable for damage to persons or things caused by failure to observe the above instructions, by interference with any part of the appliance or by the use of non-original spare parts.



3. ENVIRONMENTAL RESPONSIBILITY

Our product's packing is made of non-polluting materials, which are therefore compatible with the environment and recyclable. Please help by disposing of the packaging correctly. You can obtain the addresses of collection, recycling and disposal centres from your retailer or from the competent local organisations.



Do not discard the packaging or any part of it, or leave it unattended. It can constitute a suffocation hazard for children, especially the plastic bags.

Your old appliance also needs to be disposed of correctly.

Important: hand over your appliance to the local agency authorised for the collection of electrical appliances no longer in use. Correct disposal enables intelligent recovery of valuable materials.

Before disposing of your appliance it is important to remove doors and leave shelves in the same position as for use, to ensure that children cannot accidentally become trapped inside during play. It is also necessary to cut the connecting cable to the power grid, removing it along with the plug.



4. GET TO KNOW YOUR OVEN

Multifunction

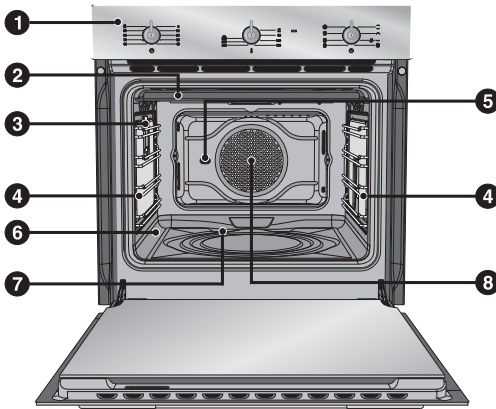

- 1 Control panel
- 2 Roof liner
- 3 Inside lights
- 4 Rack and tray support frames (on some models only)
- 5 Insert for the rotisserie rod (on some models only)
- 6 Bottom plate (on some models only)

Multifunction

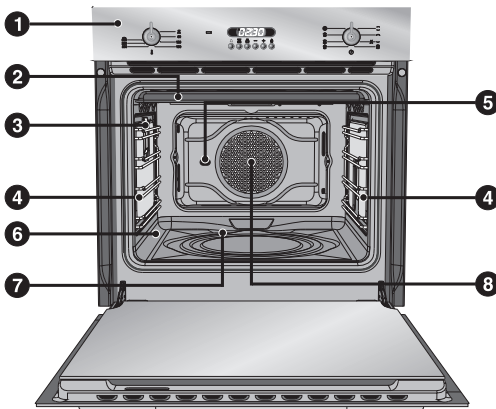

- 7 Pizza plate or cover recess (on some models only)
- 8 Oven fan

Pyrolytic

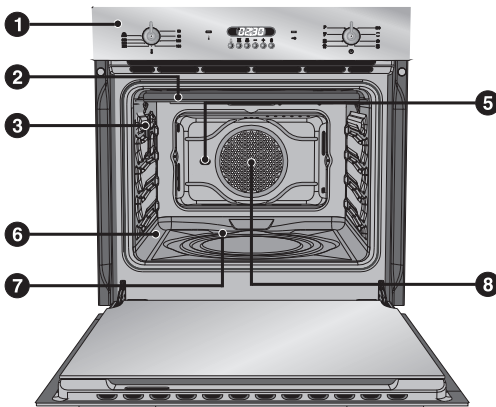



5. AVAILABLE ACCESSORIES

NOTE:

Some models are not provided with all accessories.

Rack: useful for holding cooking containers.
For use in ovens with frames.

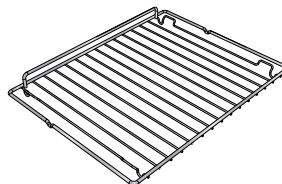

Rack: useful for holding cooking containers.
For use in ovens with moulded runners.

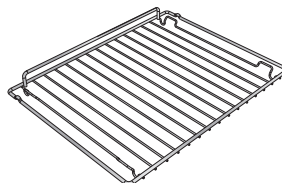

Tray rack: to be placed over the top of the oven tray; for cooking foods which may drip.



Oven tray: for collecting fat from foods placed on the rack above.



Handle: for removing hot racks and trays.

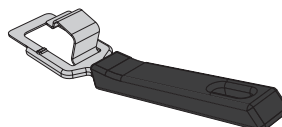

- Accessories available on request:
Original supplied and optional accessories may be ordered from any Authorised Support Centre.
- Use original SMEG accessories only.



The **rotisserie kit** is available on request, including the following accessories (to be used as described below):

Rotisserie frame: supports the rotisserie rod.

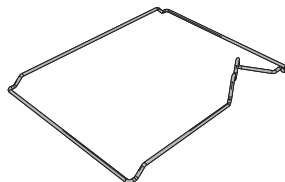

Rotisserie rod: for cooking chicken and all foods which require uniform cooking over their entire surface.



5.1 Using the rack or tray

The racks and trays are equipped with a mechanical safety lock which prevents them from being taken out accidentally. To insert the rack or tray correctly, check that the lock is facing downwards (as shown in the illustration on the right).

To remove the rack or tray, lift the front slightly.

The mechanical lock must always face the back of the oven.

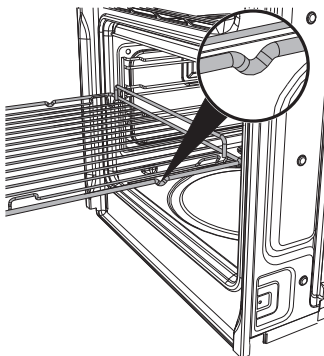

Ovens with frames

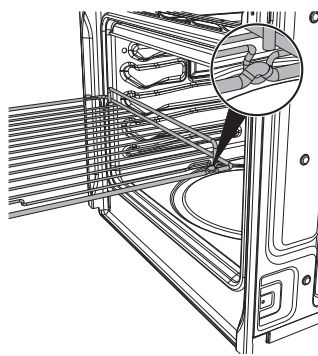

Ovens with runners



Insert racks and trays fully into the oven until they come to a stop.

5.2 Using the support rack



The support rack is inserted into the tray (as shown in the illustration).

Using this, foods can be cooked and the fat can be collected separately from the food which is being cooked.



5.3 Using the handle

The handle is used to extract hot trays and racks from the oven.

Use the accessory as shown in the illustrations.

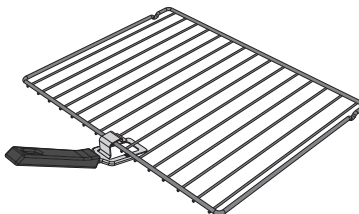
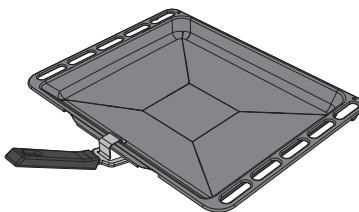



5.4 Using the rotisserie rod (on some models only)

When cooking with the rotisserie, position the frame on the third runner (see 6.2.1 Oven runners). Once the frame is inserted, the shaped part must sit facing outwards (as shown in the illustration).

Then prepare the rotisserie rod with the food, using the clip forks provided. So that you can handle the rod with the food on it readily, screw on the handle provided.

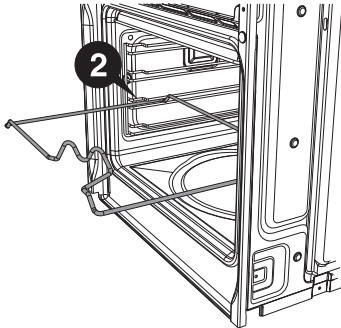

Ovens with frames

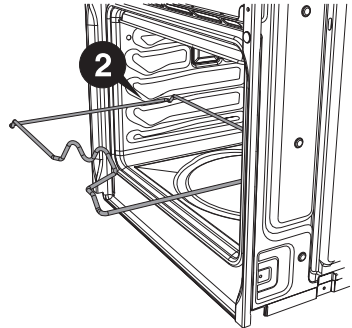

Ovens with runners

Having prepared the rotisserie rod with the food, position it on the guide frame as shown in the illustration.

Insert the rod into the hole (detail B) so that it connects with the rotisserie motor. Make sure that the pin is placed correctly on the guide frame (detail A).

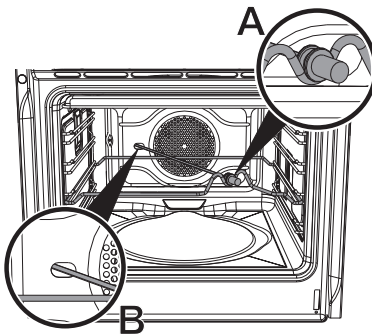

Ovens with frames

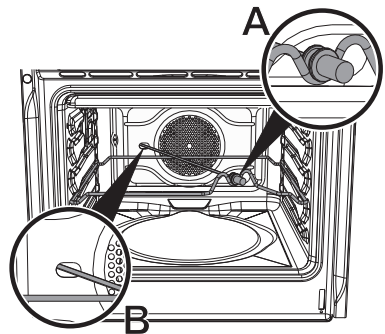

Ovens with runners



6. USING THE OVEN

6.1 Before using the appliance



- Remove any labels (apart from the technical data plate) from trays, dripping pans and the cooking compartment.
- Remove any protective film from the outside or inside of the appliance, including from accessories such as trays, dripping pans, the pizza plate or the base cover.
- Before using the appliance for the first time, remove all accessories from the oven compartment and wash them as indicated in "8. CLEANING AND MAINTENANCE".



Heat the empty appliance to the maximum temperature in order to remove any manufacturing residues which could affect the food with unpleasant odours.

6.2 General Description

6.2.1 Oven runners

The oven features **4 runners** for positioning trays and racks at different heights. The insertion heights are numbered from the bottom upwards (see illustration).

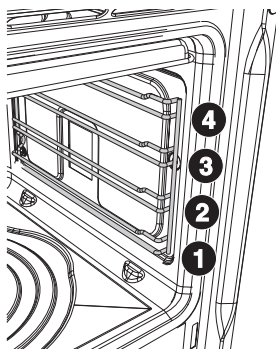

Ovens with frames

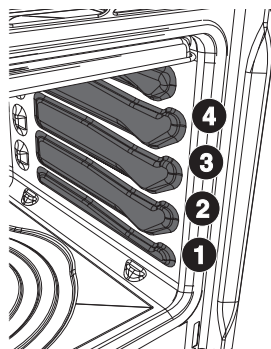

Ovens with runners



6.2.2 Cooling system

The appliance is equipped with a cooling system which comes into operation as soon as a cooking function starts. The fan causes a steady outflow of air from above the door which may continue for a brief period of time even after the oven has been turned off.

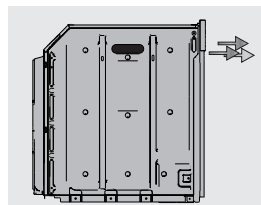

6.2.3 Oven inside lights

The oven lights come on when the door is opened or any function or recipe is selected, except for **P** (where present).



6.3 Warnings and general advice for usage



All cooking operations must be carried out with the door closed.



Cooking processes using the grill / fan-assisted grill must not last more than 20 minutes.



During cooking, do not cover the bottom of the oven with aluminium or tin foil and do not place pans or oven trays on it as this may damage the enamel coating. If you wish to use greaseproof paper, place it so that it will not interfere with the hot air circulation inside the oven.



For the best cooking results, we recommend placing cookware in the centre of the rack.

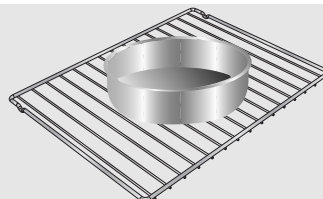

To prevent any steam in the oven from causing problems, open the door in two stages: half open (5 cm approx.) for 4-5 seconds and then fully open. If you need to access the food, always leave the door open for as short a time as possible to prevent the temperature in the oven from falling and ruining the food.

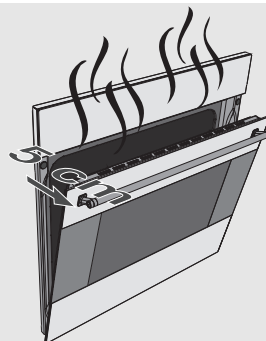

To prevent excessive amounts of condensation from forming on the internal glass, hot food should not be left inside the oven for too long after cooking.



6.4 Description of the controls on the front panel

All the appliance's control and monitoring devices are located together on the front panel.

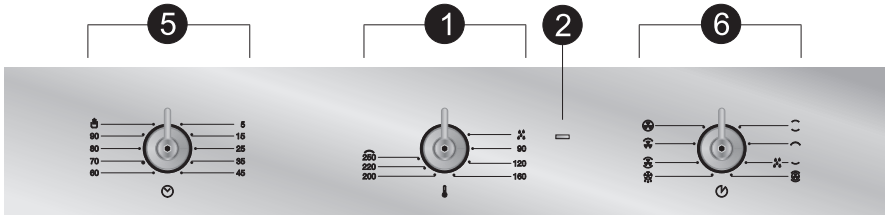

Multifunction model

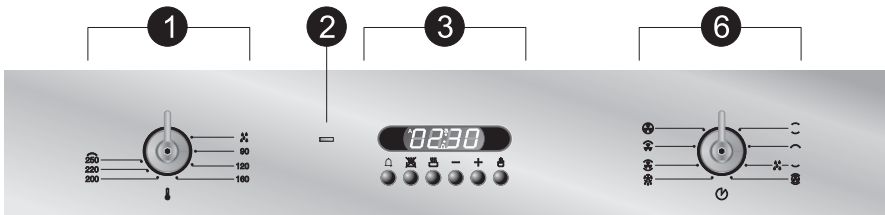

Multifunction model

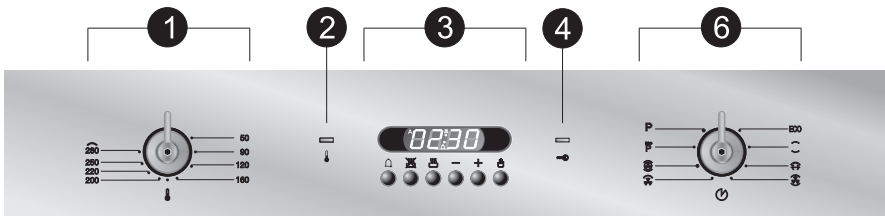

Pyrolytic Model

OVEN THERMOSTAT KNOB

1

This knob can be used to select the cooking temperature.

Turn the knob clockwise to the desired value, between 50°C and 250°C / 280°C (depending on the model).

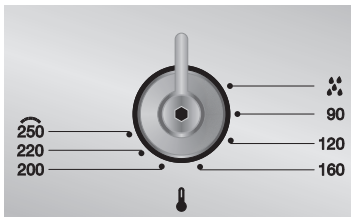

Multifunction model

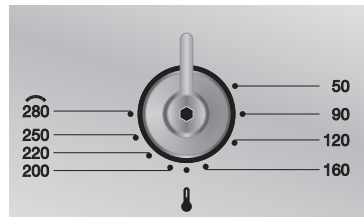

Pyrolytic Model



THERMOSTAT INDICATOR LIGHT (multifunction models)

2

The indicator light comes on to indicate that the oven is heating up.

It goes out when the set temperature is reached; When it flashes at regular intervals, the temperature inside the oven is being kept constantly at the set level.

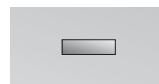

THERMOSTAT INDICATOR LIGHT (pyrolytic models)

2

When it flashes, it indicates that the oven is in the preheating phase prior to reaching the preset temperature.

Once the temperature has been reached, the light remains lit until the oven is switched off.



PROGRAMMING CLOCK (on some models only)

3

The programming clock can be used to display the current time or to set a timer or cooking programme.

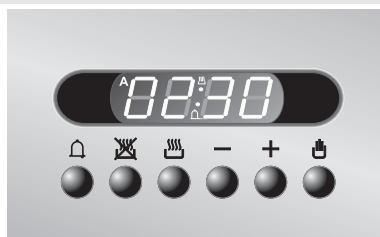

DOOR LOCK INDICATOR LIGHT (pyrolytic models)

4

When this light comes on, it indicates that the door lock device is activated. This device activates during the automatic cleaning cycle only.







5

TIMER KNOB (on some models only)

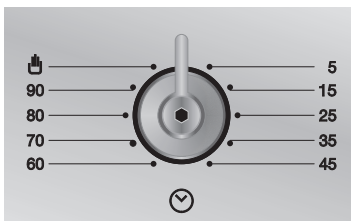
To set a cooking time, turn the knob clockwise to select the desired value in minutes. At the end, a buzzer will sound and the cooking process will be interrupted.



To start cooking with any of the functions, a cooking time must be set or the timer knob must be turned to  for cooking processes which are not timed.



FUNCTION KNOB

6

Turn the knob clockwise or anti-clockwise to select a function from the following options (see 7. COOKING WITH THE OVEN):

Some functions are not present on all models.

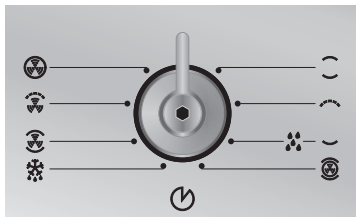

Multifunction model

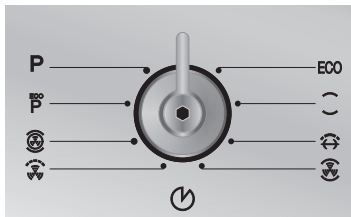

Pyrolytic Model



Eco



Static



Grill



Grill (Rotisserie)



Bottom



see 8.7 VAPOR CLEAN:
assisted oven cleaning (on
some models only)



Turbo



Defrosting



Fan-assisted static



Fan-assisted grill



Circular









Automatic cleaning cycle
see (8.6 Pyrolysis:
automatic oven cleaning (on
some models only)

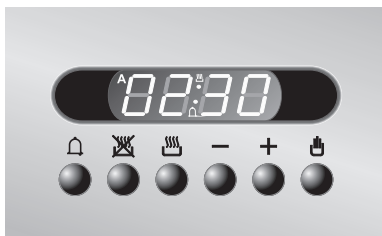





6.5 Electronic programmer (on some models only)



-  Timer button
-  End of cooking button
-  Cooking duration button
-  Value decrease button
-  Value increase button
-  Manual mode button

6.5.1 Setting the time

On the first use, or after a power failure, **00:00** will be flashing on the oven's display.







Press  to stop the flashing. The time can be set using  or . Hold down the button to increase or decrease rapidly.

6.5.2 Using the timer



Warning: the timer does not stop the cooking process. It only warns the user that the preset number of minutes have passed.

The timer can be activated at any time.



Press ; the display will show the numbers **00:00**; press and hold  and use  or  to set the desired number of minutes. When  is released, the countdown will start and  and  will appear on the display.



After the timer has been programmed, the display will go back to showing the current time; to display the remaining time, press .







6.5.3 Stopping the buzzer



The buzzer stops automatically after about seven minutes. It can be deactivated manually by pressing . If a semi-automatic or automatic cooking process is programmed, pressing  to deactivate the buzzer will ensure that cooking continues in manual mode.

6.5.4 Semi-automatic cooking



Semi-automatic cooking is the function which allows a cooking operation to be started and then ended after a specific length of time set by the user.





Having selected a function, press and hold ; the display will show the numbers ; press and hold  and simultaneously use  or  to set the desired number of minutes.







When  is released, the programmed cooking time will start and the display will show the current time together with  and **A** (to indicate that a programmed cooking process has been set).

6.5.5 Automatic cooking





Automatic cooking is the function which allows a cooking operation to be started at a set time and then ended after a specific length of time set by the user.

Having selected a function, press and hold ; the display will show the numbers ; press and hold  and simultaneously use  or  to set the desired number of minutes.

Press  and the sum of the current time plus the preset cooking time will appear on the display. Press and hold  and simultaneously press  or  to set the cooking end time. When  is released, the automatic cooking process will start and the display will show the current time together with  and **A** (to indicate that a programmed cooking process has been set).





After making the setting, press the  button to view the remaining cooking time; press the  button to view the cooking end time.



6.5.6 End of semi-automatic / automatic cooking



At the end of the cooking time the oven will switch off automatically and simultaneously a buzzer will start to sound intermittently. After the buzzer has been deactivated, the display will return to show the current time together with the  symbol to indicate that the oven has returned to manual use mode.

6.5.7 Deleting the set data

Having programmed a semi-automatic or automatic cooking process, this programming can be cancelled by holding down the key for the function which has just been programmed and simultaneously pressing  or  until  appears on the display.

The programmer will interpret the cancellation of the program as terminating the cooking process.

6.5.8 Modifying the set data

The set cooking data can be modified at any time by holding down the function button and at the same time pressing the buttons  or  to change the value.

6.5.9 Adjusting the buzzer volume

The buzzer volume can be set to 3 different levels. When the buzzer is in operation, press  to change the setting.



7. COOKING WITH THE OVEN

ECO:

ECO

Using the grill and the lower heating element in combination is particularly suitable for cooking on a single runner only, as it provides low energy consumption.



STATIC:



As the heat comes from above and below at the same time, this system is particularly suitable for certain types of food. Traditional cooking, also known as static or thermal radiation cooking, is suitable for cooking just one dish at a time. Perfect for all types of roasts, bread and cakes and in any case particularly suitable for fatty meats such as goose and duck.

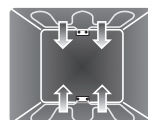

GRILL:



The heat coming from the grill element gives perfect grilling results, especially for thin and medium thickness meat and, in combination with the rotisserie (when present), it allows the food to be browned evenly at the end of cooking. Perfect for sausages, ribs and bacon. This function enables large quantities of food, particularly meat, to be grilled evenly. (3rd or 4th runner).

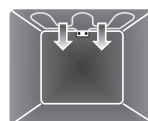

ROTISSERIE GRILL: (on the pyrolytic model only)



The rotisserie functions in combination with the grill element allow to perfectly brown food.

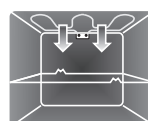

BOTTOM:



The heat coming solely from the bottom makes it possible to complete the cooking of foods that require a greater basic temperature, without affecting their browning. Perfect for cakes, pies, tarts and pizzas.

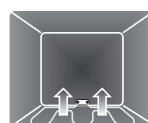

FAN-ASSISTED STATIC:



The operation of the fan, combined with traditional cooking, ensures uniform cooking even with complex recipes. Perfect for biscuits and cakes, even when simultaneously cooked on several levels.

(For multiple-level cooking, you are advised to use the 1st and 3rd runners.)





FAN-ASSISTED GRILL:



The air produced by the fan softens the strong heatwave generated by the grill, giving perfect grilling even with very thick foods. Perfect for large cuts of meat (e.g. shin of pork). We recommend using the 3rd runner.

In pyrolytic models, this function also includes defrosting and proving, see 7.4 Proving and defrosting functions.

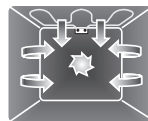

CIRCULAR:



The combination of the fan and the circular element (incorporated in the rear of the oven) enables different foods to be cooked on several levels, as long as they need the same temperature and cooking time. Hot air circulation ensures instant and uniform distribution of heat. It will be possible, for instance, to cook fish, vegetables and biscuits simultaneously (on different levels) without mixing smells and flavours.

(For multiple-level cooking, you are advised to use the 1st and 3rd runners.)

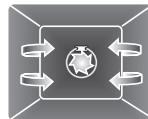

TURBO:



The combination of fan-assisted cooking and traditional cooking enables different foods to be cooked on several levels extremely quickly and efficiently, without any transfer of smells and flavours.

Perfect for large volumes that call for intense cooking.

(For multiple-level cooking, you are advised to use the 1st and 3rd runners.)



DEFROSTING: (see 7.4 Proving and defrosting functions)



Rapid defrosting is assisted by switching on the fan. The movement of air caused by the fan makes food defrost faster. The air circulating inside the oven is at room temperature.

(You are advised to use the 1st or 2nd runner)

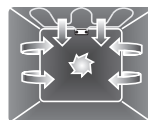



7.1 Cooking advice and instructions

7.1.1 General advice

We recommend preheating the oven before putting the food in. Do not put food into the compartment until the warning light has switched off to indicate that the preset temperature has been reached or until the display is flashing.

For cooking on several levels, we recommend using a fan-assisted function to achieve uniform cooking at all heights.

In general, it is not possible to shorten the cooking times by increasing the temperature (the food could be well-cooked on the outside and undercooked on the inside).

7.1.2 Advice for cooking meat

Cooking times, especially for meat, vary according to the thickness and quality of the food and to consumer's taste.

We recommend using a meat thermometer for meat when roasting it. Alternatively, simply press on the roast with a spoon: if it is hard, it is ready; if not, it needs another few minutes cooking.

7.1.3 Advice for cooking desserts and biscuits

Use dark metal moulds for desserts: they help to absorb the heat better.

The temperature and the cooking duration depend on the quality and consistency of the dough.

Check whether the dessert is cooked all the way through: at the end of the cooking time, put a toothpick into the highest point of the dessert. If the dough does not stick to the toothpick, the dessert is cooked.

If the dessert collapses when it comes out of the oven, on the next occasion reduce the set temperature by about 10°C, selecting a longer cooking time if necessary.

7.1.4 Advice for defrosting and proving

We recommend positioning frozen foods in a lidless container on the first runner of the oven.

The food must be defrosted without its wrapping.

Lay out the foodstuffs to be defrosted evenly, not overlapping.



When defrosting meat, we recommend using a rack positioned on the second runner with the food on it and a tray positioned on the first runner. In this way, the liquid from the defrosting food drains away from the food.

The most delicate parts can be covered with aluminium foil.

For successful proving, a container of water should be placed in the bottom of the oven.

7.1.5 Advice for cooking with the Grill and the Fan-assisted grill

Using the Grill function , meat can be grilled even when it is put into the oven cold; preheating is recommended if you wish to change the effect of the cooking.

With the Fan-assisted grill function , however, we recommend that you preheat the oven before grilling.

















7.2 To save energy

To save energy during use of the appliance, the following instructions may be followed:

- Stop cooking a few minutes before the time normally used. Cooking will continue for the remaining minutes with the heat which has accumulated inside the oven.
- Reduce any opening of the door to a minimum to avoid heat dispersal.
- Use the ECO function (on some models only) for cooking on a single runner.
- Keep the inside of the appliance clean at all times.























7.3 Cooking process information table

DISHES	WEIGHT	FUNCTION
FIRST COURSES		
LASAGNE	3 kg	 Static
OVEN-BAKED PASTA		 Static
MEAT		
ROAST VEAL	1 kg	 Fan-assisted static
LOIN OF PORK	1 kg	 Fan-assisted static
SHOULDER OF PORK	1 kg	 Turbo / Circular
ROAST RABBIT	1 kg	 Circular
TURKEY BREAST	1 kg	 Fan-assisted static
ROAST NECK OF PORK	1 kg	 Turbo
ROAST CHICKEN	1 kg	 Turbo
GRILLED MEATS		
PORK CHOPS		 Fan-assisted grill
FILLET OF PORK		 Grill
FILLET OF BEEF		 Grill
LIVER		 Fan-assisted grill
SAUSAGES		 Fan-assisted grill
MEAT BALLS		 Grill
ROTISSERIE MEATS		
CHICKEN		 Rotisserie grill
FISH		
SALMON TROUT	0.7 kg	 Fan-assisted static



RUNNER POSITION FROM BOTTOM	TEMPERATURE °C	TIME IN MINUTES	
1-2	220 - 230	40 - 50	
1-2	220 - 230	40	
2	180 - 190	70 - 80	
2	180 - 190	70 - 80	
2	180 - 190	90 - 100	
2	180 - 190	70 - 80	
2	180 - 190	110 - 120	
2	180 - 190	110 - 120	
2	190 - 200	60 - 70	
		1 ST SURFACE	2 ND SURFACE
4	250 - 280	7 - 9	5 - 7
3	250 - 280	9 - 11	5 - 9
3	250 - 280	9 - 11	9 - 11
4	250 - 280	2 - 3	2 - 3
3	250 - 280	7 - 9	5 - 6
3	250 - 280	7 - 9	5 - 6
On a rotisserie rod	250 - 280	60 - 70	
2	160 - 170	35 - 40	



DISHES	WEIGHT	FUNCTION
PIZZA		 Fan-assisted static
BREAD		 Circular
FOCACCIA		 -  Turbo / Circular
DESSERTS		
DOUGHNUT		 Fan-assisted static
FRUIT TART		 Fan-assisted static
FRUIT TART		 Static
SHORT PASTRY		 Circular
JAM TARTS		 -  Turbo / Circular
PARADISE CAKE		 Fan-assisted static
PARADISE CAKE		 Static
ECLAIR		 -  Turbo / Circular
LIGHT SPONGE CAKE		 Circular
RICE PUDDING		 -  Turbo / Circular
RICE PUDDING		 Static
CROISSANTS		 Circular
APPLE PIE		 Static

The times indicated in the following tables do not include the preheating times and are provided as a guide only. Always preheat the oven first and put food inside when the oven is hot.



RUNNER POSITION FROM BOTTOM	TEMPERATURE °C	TIME IN MINUTES
1	280	8
2	190 - 200	30 -35
2	180 - 190	15 -20
2	160 - 170	50 - 55
2	160 - 170	30 - 35
2	170	35 - 40
2	160 - 170	20 - 25
2	170	20 - 25
2	160 - 170	50 - 60
2	170	50 - 60
2	150 - 160	40 - 50
2	150 - 160	45 - 50
2	160	40 - 50
2	170	50 - 60
2	160	25 - 30
3	180	60

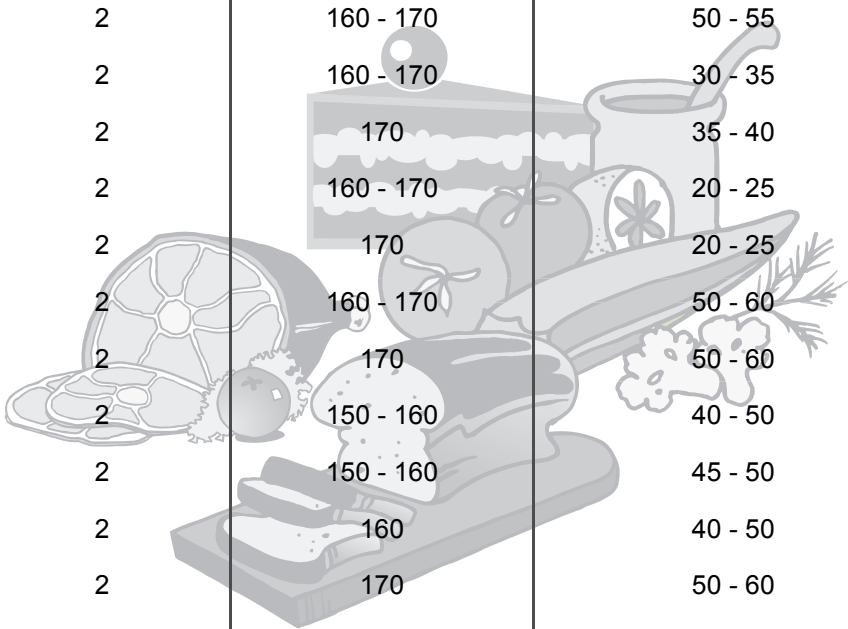



7.4 Proving and defrosting functions

On pyrolytic models only:

The special defrosting and proving functions are brought together under the same function indicated by .

The choice of temperature determines whether defrosting or proving takes place based on the table below.

Temperature (°C)	Function	Runner position from the bottom	Time in minutes
30	Defrosting	1	Depending on the quantity
40	Proving	1	



8. CLEANING AND MAINTENANCE



NEVER USE A STEAM JET FOR CLEANING THE APPLIANCE.



We recommend the use of cleaning products distributed by SMEG.

8.1 Cleaning stainless steel

To keep stainless steel in good condition it should be cleaned regularly after use. Let it cool first.

8.2 Ordinary daily cleaning

To clean and preserve the stainless steel surfaces, always use **only** specific products that do not contain abrasives or chlorine-based acids.

How to use: pour the product onto a damp cloth and wipe the surface, rinse thoroughly and dry with a soft cloth or a microfibre cloth.

8.3 Food stains or residues

Do not use steel sponges or sharp scrapers as they will damage the surface.

Use normal non-abrasive products and a wooden or plastic tool if necessary. Rinse thoroughly and dry with a soft cloth or a microfibre cloth.



Do not allow residues of sugary foods (such as jam) to set inside the oven. If left to set for too long, they might damage the enamel lining of the oven.



8.4 Cleaning the door glazing

The glass in the door should always be kept thoroughly clean. Use absorbent kitchen roll; remove stubborn dirt with a damp sponge and an ordinary detergent.



Do not use abrasive or corrosive cleaners for cleaning the door glazing. (e.g. powder products, oven-cleaner sprays, stain removers and metal scouring pads).

Do not use rough or abrasive materials or sharp metal scrapers to clean the oven's glass doors since they may scratch the surface.



8.5 Cleaning the inside of the oven

For the best oven upkeep, clean it regularly after having allowed it to cool.

- Take out all removable parts.
- Clean the oven racks with hot water and non-abrasive detergent. Rinse and dry.
- For easier cleaning, the door can be removed (see “9.2 Removing the door”).

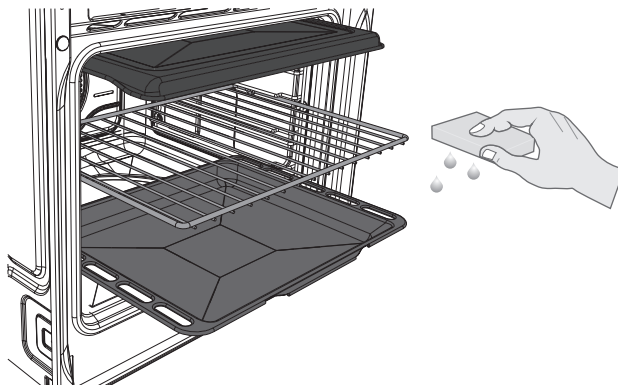

The oven should be operated at the maximum heat setting for 15/20 minutes after use of specific products, to burn off the residues left inside the oven.



On pizza models only, to clean the bottom of the oven, the following operations have to be carried out first:

Remove the cover then the base on which it is resting. The base must be lifted a few millimetres, then pulled outwards.

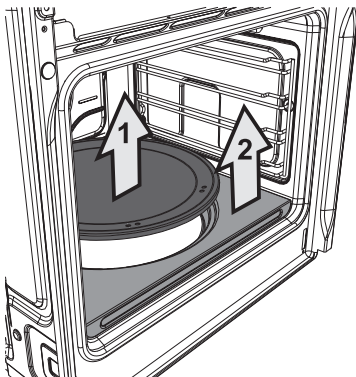

Ovens with frames

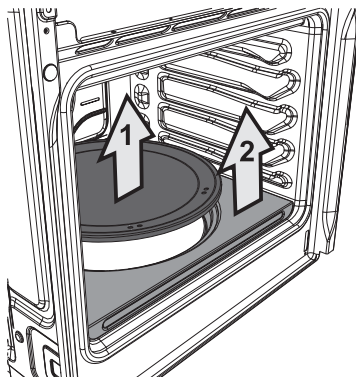

Ovens with runners

Lift up the edge of the lower heating element a few centimetres and clean the bottom.

Put the pizza plate support back in place, pushing it in until it hits the back of the oven, and push it down so that the heating element plate is embedded into the base itself.

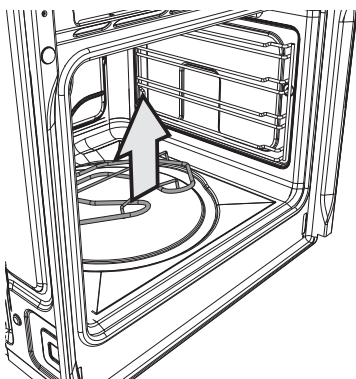

Ovens with frames

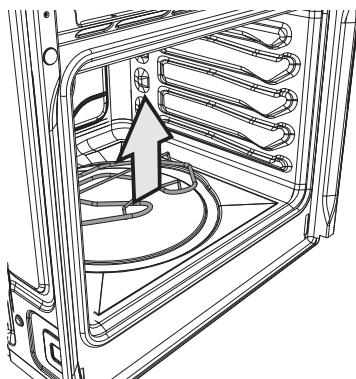

Ovens with runners



When the operation is complete, damp parts should be dried thoroughly.



8.5.1 Removing guide frames

Removing the guide frames makes it easier to clean the side parts, and it also needs to be done whenever the automatic cleaning cycle is used (only available on some models).

- To remove the guide frames, pull the frame towards the inside of the oven to unhook it from its housing **A**, then slide it out of the seats at the back **B**.
- When cleaning is complete, repeat the above procedures to put the guide frames back in.

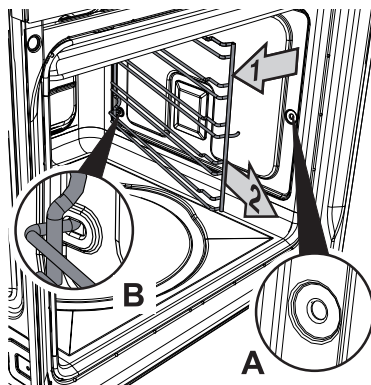



8.6 Pyrolysis: automatic oven cleaning (on some models only)

P

Pyrolysis is an automatic high-temperature cleaning procedure which causes dirt to dissolve. Thanks to this process, it is possible to clean the inside of the oven very easily.



During the first automatic cleaning cycle, unpleasant smells may occur due to the normal evaporation of oily manufacturing substances. This is an absolutely normal phenomenon which disappears after the first cleaning cycle.



Before starting the automatic cleaning cycle, make sure that the oven does not contain any foods or large spills from previous cooking operations.



During the pyrolysis cycle, a door locking device makes it impossible to open the door.



IF THE OVEN IS INSTALLED UNDERNEATH A HOB, MAKE SURE THAT THE BURNERS OR ELECTRIC PLATES REMAIN OFF DURING THE AUTOMATIC CLEANING CYCLE.



8.6.1 Before starting the automatic cleaning cycle

Pyrolysis may be carried out at any time of the day or night (if you wish to benefit from the lower cost of electricity overnight).

- Completely remove all accessories from inside the oven and the roof lining, as shown in the illustration.

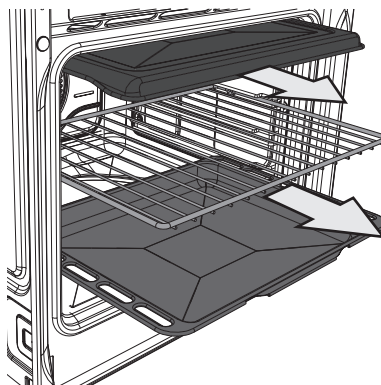

- Make sure that the oven door is firmly closed.

Refer to the following diagram for setting the cleaning cycle duration:

CLEANING DURATION	LIGHT DIRT	MEDIUM DIRT	HEAVY DIRT
	90 MIN.	135 MIN.	180 MIN.



During the automatic cleaning cycle, the fans produce a more intense level of noise due to a greater rotation speed; this is entirely normal and intended to facilitate heat dissipation.

At the end of pyrolysis, the fans will continue to operate for long enough to avoid overheating the walls of adjacent units and the front of the oven.



8.6.2 Setting the cleaning cycle

Turn the function selection knob to select one of the two cleaning cycles out of **ECO P** and **P**.

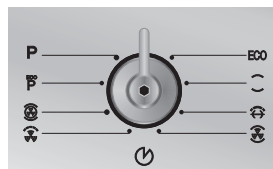

To start the cleaning cycle (Pyrolysis), press  followed by **+**.

Press and hold ; press **-** or **+** to set the duration of the cycle between a minimum of 1h 30m and a maximum of 3h 00m (apart from the **ECO P** cycle where the duration is set at 1h 30m).

Two minutes after the cleaning cycle (Pyrolysis) starts, a locking device which prevents opening of the door will be tripped. The relevant light will switch on to indicate that the locking device has been activated.



At the end of the cleaning cycle, the locking device will remain active until the temperature inside the oven has reached a safety threshold. When the oven has cooled down, collect the residues from automatic cleaning with a damp microfibre cloth.

To select a cleaning cycle with a delayed start, after setting the duration press .

The time when the cleaning cycle will terminate will appear on the display.

Press and hold , and press **-** or **+** to set the time at which you wish to terminate the cleaning cycle.



It is not possible to select any functions once the door locking device has been activated. Wait for  to go out.



8.7 VAPOR CLEAN: assisted oven cleaning (on some models only)



VAPOR CLEAN is an assisted cleaning procedure which facilitates the removal of dirt. Thanks to this process, it is possible to clean the inside of the oven very easily. The dirt residues are softened by the heat and water vapour for an easier removal afterwards.



Before starting the assisted cleaning cycle, make sure that the oven does not contain any foods or large spills from previous cooking operations.



Carry out assisted oven cleaning operations only when the oven is cold.

8.7.1 Before starting the assisted cleaning cycle

- Completely remove all accessories from inside the oven. The roof lining can be left inside the oven.

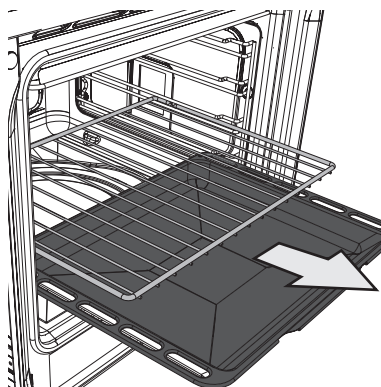

- Pour approx. 40cl of water onto the floor of the oven (as shown in the illustration). Make sure it does not overflow out of the cavity.

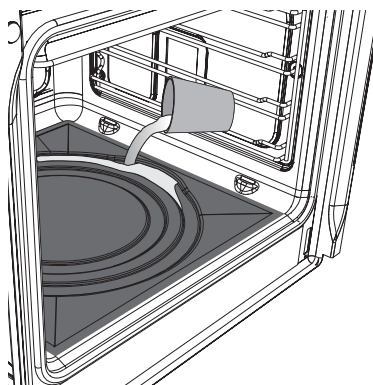



- Spray a water and washing up liquid solution inside the oven using a spray nozzle. Aim the spray towards the side walls, roof, floor and deflector (the coloured zone on the illustration to the side shows where the solution can be sprayed).

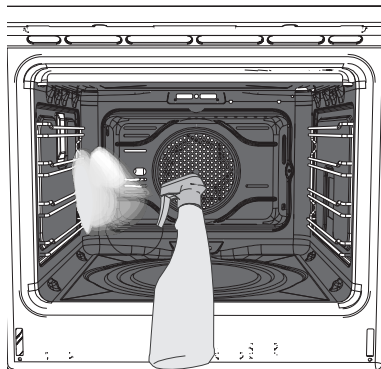



Do not spray excessive amounts of the water and washing up liquid solution. We recommend spraying approx. 20 times at the most.

- Close the door and set the assisted cleaning cycle.

8.7.2 Setting the assisted cleaning cycle

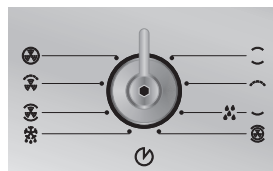
Turn the function selection knob to select the VAPOR CLEAN  cleaning cycle.



To start the cleaning cycle (VAPOR CLEAN), the temperature selection knob must be turned to .

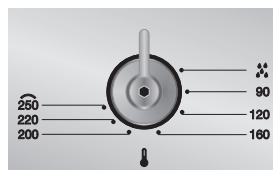

Leave the appliance in operation for 18 minutes. Then stop the cycle by turning the knobs back to "0".



8.7.3 End of the assisted cleaning cycle



The water remaining at the end of the assisted cleaning cycle cannot be left inside the oven for long (for example overnight).



You are advised to wear a pair of gloves during these processes.

At the end of the cleaning cycle, open the door and wipe away the less stubborn dirt with a microfibre cloth. Use an anti-scratch sponge with brass filaments on more difficult encrustations (we recommend removing the door to facilitate access to restricted spaces). Dry the oven with a microfibre cloth.

For improved hygiene and to avoid food being affected by any unpleasant odours, we recommend that the oven is dried using a fan function at 160°C for approximately 10 minutes.



9. EXTRAORDINARY MAINTENANCE

The oven may require extraordinary maintenance or replacement of parts subject to wear such as gaskets, bulbs, etc. The following instructions describe how to carry out these minor maintenance operations.



Before any intervention that requires access to live parts, disconnect the power supply of the appliance.

9.1 Replacing the light bulb

If a light bulb needs to be replaced because it is worn or burnt out (in multifunction models remove the guide frames; see “8.5.1 Removing guide frames”).

Then remove the bulb cover using a tool (e.g. a screwdriver).

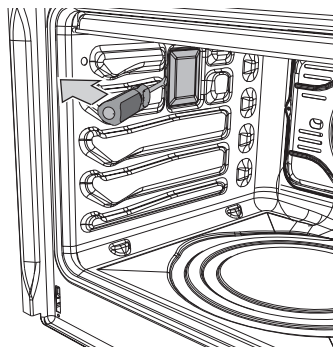
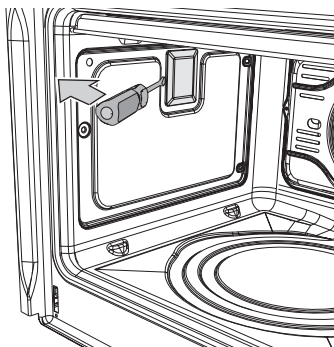

Remove the bulb by sliding it out as shown.

On some models only: the bulbs are halogen bulbs, so **do not touch them directly with your fingers**, wrap them in an insulating material.

Replace the bulb with one of the same type (25W). Replace the cover correctly, so that the moulded part of the glass is facing the door.

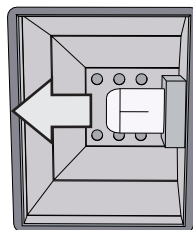

Press the cover down as far as it will go so that it attaches completely to the bulb support.



9.2 Removing the door

9.2.1 With moveable levers

Open the door completely.
Lift the levers **A** of the two hinges away from them until they engage.

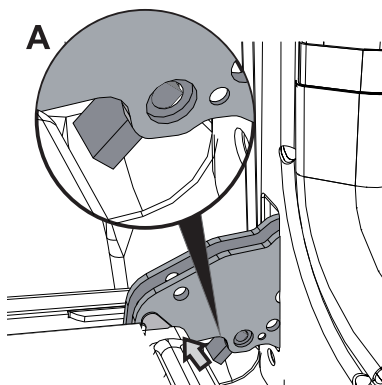

Grasp the door on both sides with both hands, lift it forming an angle of around 30° and remove it.

If the hinges have not unlocked, repeat the operation, raising the levers **A** and keeping the door slightly raised.

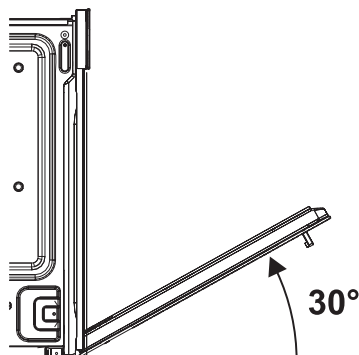

To reassemble the door, put the hinges in the relevant slots in the oven, making sure that the grooved sections **C** are resting completely in the slots. Lower the door and once it is in position, disengage the levers **A**.

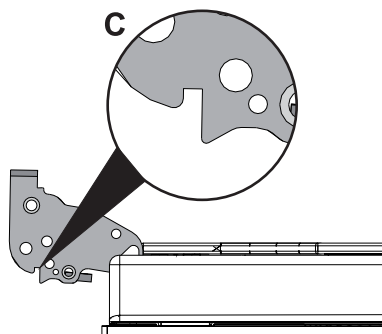



9.2.2 With pins

Open the door completely.
Insert two pins into the holes indicated **A** in the two hinges towards the back of them until they engage.

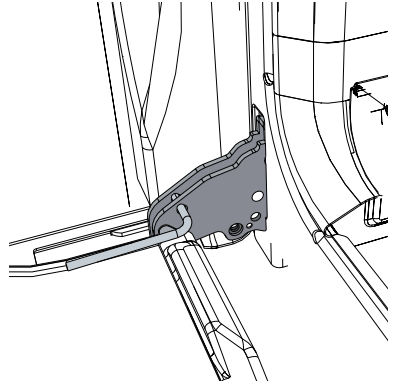

Grasp the door on both sides with both hands, lift it forming an angle of around 30° and remove it.

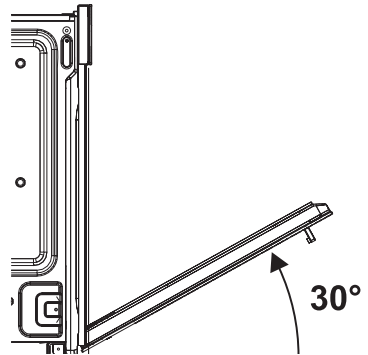

To reassemble the door, put the hinges in the relevant slots in the oven, making sure that the grooved sections **C** are resting completely in the slots. Lower the door and once it is in place remove the pins from the holes in the hinges.

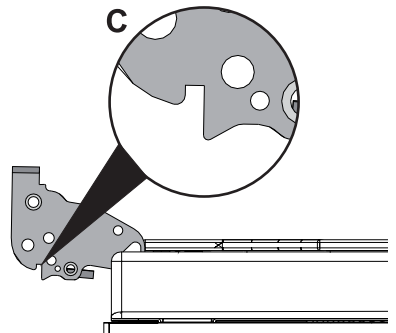



9.3 Removing the door seal

For multifunction models only:

To permit thorough cleaning of the oven, the door seal may be removed.

There are fasteners on all four sides to attach it to the edge of the oven. Pull the edges of the seal outwards to detach the fasteners.

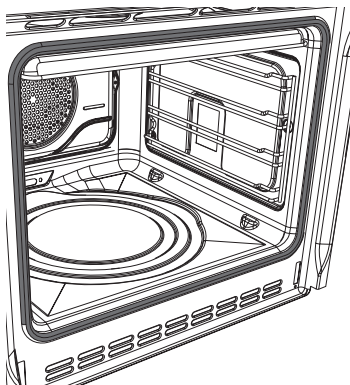

9.4 Removing the internal glass panels

The glass in the door should always be kept thoroughly clean. To facilitate cleaning, it is possible to remove the door (see 9.2 Removing the door) and place it on a canvas, or open it and lock the hinges in order to extract the glass panels.

The glass panels of the door can be completely removed by following the instructions provided below.



Warning: before removing the glass panels, make sure that at least one of the door's hinges has been locked in the open position as described in "9.2 Removing the door". This operation may have to be repeated during the glass removal process if the door is accidentally freed.



1

Removing the internal glass panel:

- Remove the internal glass panel by pulling it upwards, following the movement indicated by the arrows. Doing this detaches the 4 pins attached to the glass from their slots in the oven door.

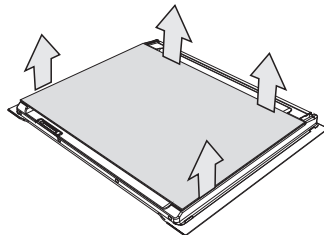

2

Removing the middle glass panels: (pyrolytic models)

- There are two middle glass panels in pyrolytic models, attached using 4 small locks. Remove the middle panels by lifting them upwards.

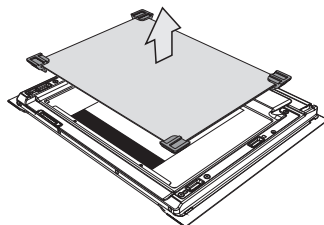

(Multifunction models)

- Multifunction models have a single middle panel. Remove the middle panel by lifting it upwards.

3

Cleaning:

- Now it is possible to clean the external glass panel and the panels removed previously. Use absorbent kitchen roll. In the case of stubborn dirt, wash with a damp sponge and neutral detergent.

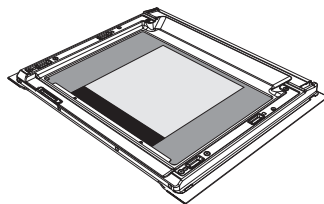

4

Replacing the glass panels:

- Replace the panels in the reverse of the order in which they were removed.
- Reposition the internal glass panel, taking care to centre and insert the 4 pins attached to the glass into their slots in the oven door by applying slight pressure.

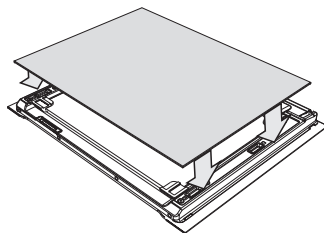



10. INSTALLING THE APPLIANCE

10.1 Electrical connection



The identification plate bearing the technical data, serial number and brand name is visibly positioned on the appliance.

Do not remove this plate for any reason.



The appliance must be connected to earth in compliance with electrical system safety regulations.



If a fixed connection is being used, fit the power line with an omnipolar circuit-breaker in accordance with the installation rules, located in a position which is easy to reach and near the appliance.



If a plug and socket connection is being used, make sure that the plug and socket are compatible. Avoid use of adapters and shunts as these could cause overheating and a risk of burns.

Operation at 220-240 V~: use a H05V2V2-F type **220-240V~** three-core cable (3 x 1.5 mm²).

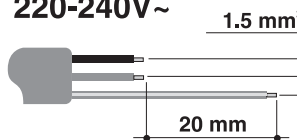

The end to be connected to the appliance must have an earth wire (yellow-green) at least 20 mm longer than the others.



WARNING: The values indicated above refer to the cross-section of the internal conductor.

10.2 Cable replacement

Should the supply cable need replacing, remove the back guard by unscrewing the screws to gain access to the terminal.

Replace the cable. The cable cross-section must be no less than 1.5 mm² (3 x 1.5) (see 10.1 Electrical connection).

Make sure that the cables (for the oven or any hob) follow the best route in order to avoid any contact with the oven.

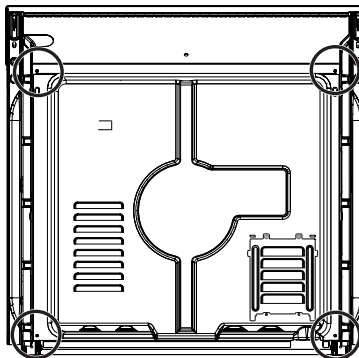

WARNING: The tightening torque of the screws of the terminal supply wires must be **1.5 - 2 Nm**.



10.3 Positioning the oven



Never use the oven door to lever the oven into place when fitting. Avoid exerting too much pressure on the door when open.



We recommend installing the oven with the help of a second person.



The base on which the oven is resting must be complete as shown in the illustrations below.

The oven is designed for mounting into any piece of furniture as long as it is heat-resistant (90°C).

Proceed according to the dimensions shown in Figures 1, 2 and 3.

For installing under a work top, follow the dimensions given in Figures 1 and 2.

For installing under a work top with combined cooking hobs, ensure a minimum clearance from any side walls of at least 110 mm.



When installing in tall units, comply with the dimensions shown in figures 1 and 2, bearing in mind that the top/rear of the unit must have an opening 35-40 mm deep.

Remove the screw covers on the frame and screw in the 2 screws **A** (fig. 5) to fix the appliance to the unit. Replace the screw covers. For installing beneath a countertop hob, allow for a rear and bottom clearance as shown in Figure 1 (ref. F).

See the relevant instructions for fitting and securing the appliance.

FIG.1

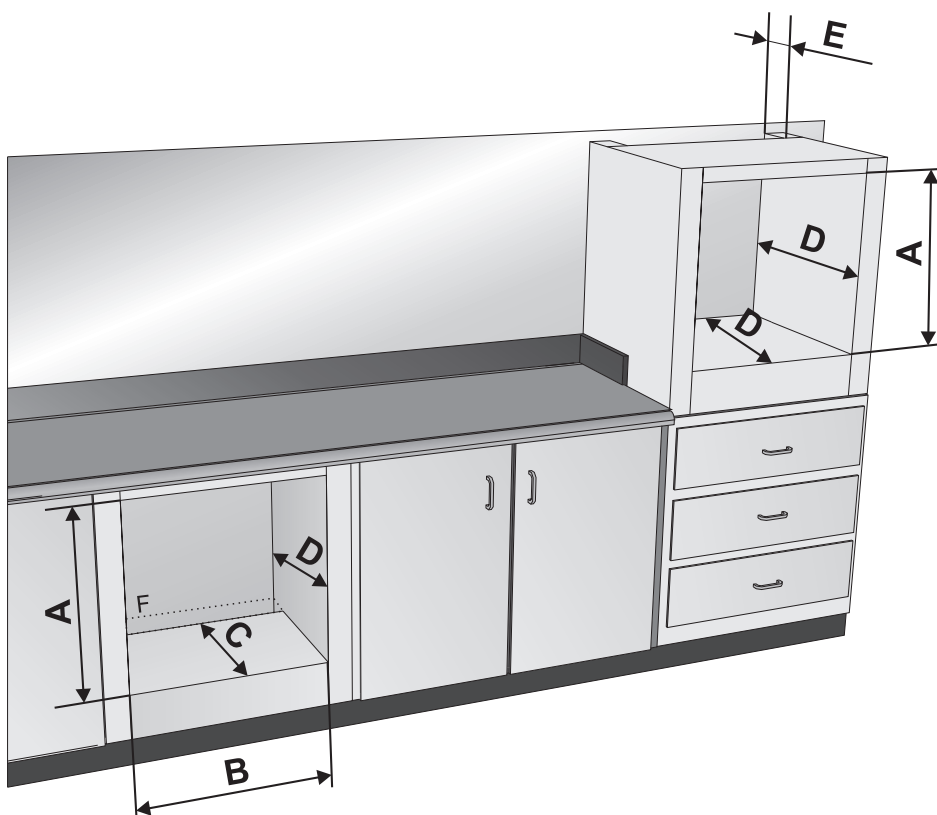

	A	B	C	D	E
Measurements (mm)	583 ÷ 585	554 ÷ 564	490 ÷ 500	560 min.	35 ÷ 40



FIG. 2

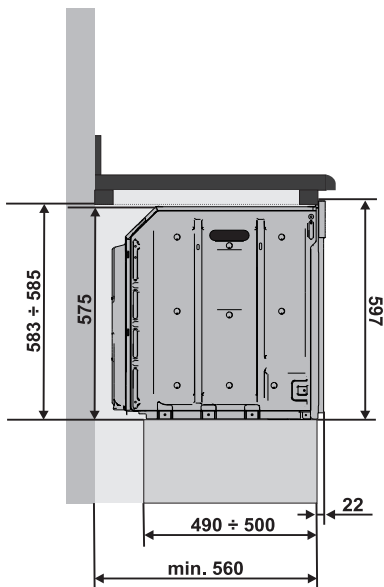

FIG. 3

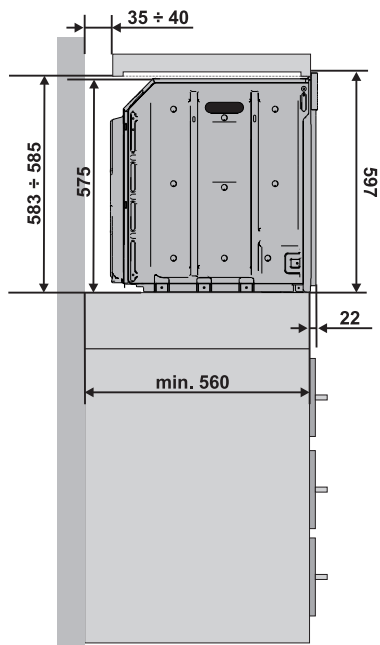

FIG. 4

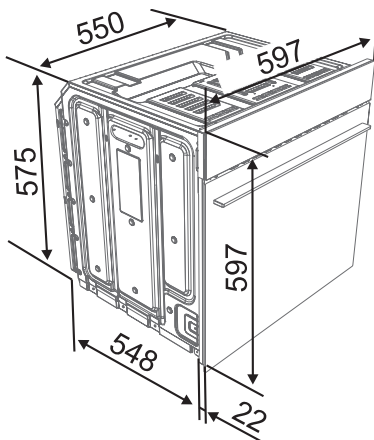
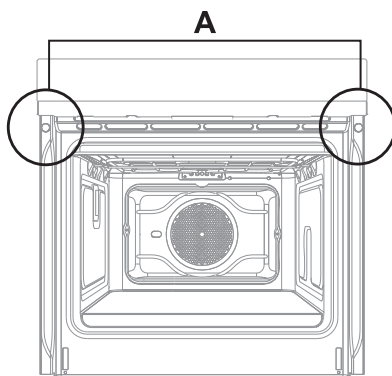
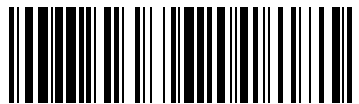

FIG. 5





914773682/ A

Free Manuals Download Website

<http://myh66.com>

<http://usermanuals.us>

<http://www.somanuals.com>

<http://www.4manuals.cc>

<http://www.manual-lib.com>

<http://www.404manual.com>

<http://www.luxmanual.com>

<http://aubethermostatmanual.com>

Golf course search by state

<http://golfingnear.com>

Email search by domain

<http://emailbydomain.com>

Auto manuals search

<http://auto.somanuals.com>

TV manuals search

<http://tv.somanuals.com>