

GE Consumer & Industrial  
Power Protection

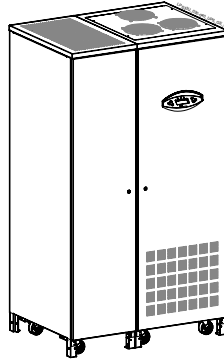

Operating Manual  
Uninterruptible Power supply

**Digital Energy™**  
*LP 33 Series*

30 & 40 kVA  
208 VAC UL / Series 0

**Manufactured by:**

GE Zenith Controls  
General Electric Company  
2501 Pecan Street  
Bonham, Texas 75418  
T 903 640 7900  
T 903 640 7900

[www.geindustrial.com/cwc/home](http://www.geindustrial.com/cwc/home)



GE imagination at work



Model: **LP 33 Series / 30 & 40 kVA** / Series 0  
Date of issue: 01/01/2005  
File name: OPM\_LPS\_3UO\_30K\_40K\_OUS\_V010  
Revision: 1.0  
Identification No.

<b>Up-dating</b>		
Revision	Concerns	Date

**COPYRIGHT © 2005 by GE Consumer & Industrial**

All rights reserved.

The information contained in this publication is intended solely for the purposes indicated.

The present publication and any other documentation supplied with the UPS system is not to be reproduced, either in part or in its entirety, without the prior written consent of **GE**.

The illustrations and plans describing the equipment are intended as general reference only and are not necessarily complete in every detail.

The content of this publication may be subject to modification without prior notice.

**Dear Customer,**

We thank you for selecting our products and are pleased to count you amongst our very valued customers at **GE**.

We trust that the use of the **LP 33 Series** Uninterruptible Power Supply system, developed and produced to the highest standards of quality, will give you complete satisfaction.

Please carefully read the *Installation Guide*. It contains all the necessary information about the installation of the UPS.  
Thank you for choosing **GE** !

	<p><b>START UP AND COMMISSIONING</b></p> <p>A GE Global Services Field Engineer must perform start-up and commissioning of the UPS. Please Contact G.E. Global Services at least two weeks prior to schedule start-up and commissioning at 1-800-637-1738, or by E-mail at <a href="mailto:gedeservices@indsys.ge.com">gedeservices@indsys.ge.com</a></p>
---	---

Manufactured by:

GE Digital Energy General Electric Company CH - 6595 Riazzino (Locarno) Switzerland

Distributed by:

--

Your service contact:

--

## Preface

Congratulations on your choice of a *LP 33 Series* Uninterruptible Power Supply (UPS). It will help eliminate load disturbances due to unexpected power problem.

This *Installation Guide* describes how to prepare the installation site, and it provides weight and dimensions and procedures for moving, installing and connecting the UPS.

While every care has been taken to ensure the completeness and accuracy of this manual, *GE* assumes no responsibility or liability for any losses or damages resulting from the use of the information contained in this document.

### WARNING!

*LP 33 Series / 30 & 40 kVA*, is a product that needs to be installed by a licensed and knowledgeable contractor.

We recommend that this manual be kept next to the UPS for future references. If any problems are encountered with the procedures contained in this manual, please contact your *Service Center* before you proceed.

This document shall not be copied or reproduced without the permission of *GE*.

Some of the information contained in this manual may be changed without notice to reflect technical improvements.

## Safety instructions

Read the safety instructions contained on the following pages carefully before the installation of the UPS, options and battery system.

Pay attention to the rectangular boxes included in the text:

They contain important information and warning concerning electrical connections and personnel safety.

# RPA

Redundant Parallel  
Architecture

***Parallel version secured with RPA***

***When included in the text, this symbol refers to operation needed only for parallel system.***

# Table of contents

Page

<b>1</b>	<b>SAFETY RULES</b> .....	<b>6</b>
<b>2</b>	<b>INTRODUCTION</b> .....	<b>9</b>
2.1	GENERAL DESCRIPTION.....	9
<b>3</b>	<b>DESCRIPTION</b> .....	<b>10</b>
3.1	BLOCK DIAGRAM AND MAIN ELEMENTS DESCRIPTION .....	10
3.2	OPERATION MODES.....	11
3.3	RPA PARALLEL SYSTEM.....	14
3.4	UPS PARALLELED ON THE SAME BATTERY.....	15
3.5	SERVICE AND TECHNICAL SUPPORT.....	16
3.6	RECYCLING AT THE END OF SERVICE LIFE .....	17
<b>4</b>	<b>LAYOUT</b> .....	<b>18</b>
4.1	LAYOUT <i>LP 33 SERIES / 30 &amp; 40 KVA</i> .....	18
<b>5</b>	<b>SYSTEM HANDLING</b> .....	<b>19</b>
5.1	CONTROL PANEL .....	19
5.2	COMMAND PUSH BUTTONS AND SWITCHES .....	20
<b>6</b>	<b>LCD SCREEN</b> .....	<b>21</b>
6.1	METERING SCREENS (METERING).....	21
6.2	EVENT SCREENS (ALARM).....	23
6.2.1	Alarms list.....	23
6.2.2	Messages list.....	26
6.2.3	Event report <i>LP 33 Series</i> .....	29
6.3	MENU SCREENS (MENU).....	30
6.3.1	User parameters screen.....	31
<b>7</b>	<b>OPERATION</b> .....	<b>35</b>
7.1	PROCEDURES FOR SINGLE <i>LP 33 SERIES</i> .....	35
7.1.1	Start-up of the <i>LP 33 Series</i> .....	35
7.1.2	UPS shutdown with load transfer on manual bypass (Q2) .....	37
7.1.3	Start-up following the operation on manual bypass (Q2).....	39
7.1.4	Complete shutdown .....	40
7.1.5	Restore to normal operation after "total off" .....	41
7.1.6	Restore to normal operation after "EPO – Emergency Power Off" .....	42
7.2	PROCEDURES FOR PARALLEL SYSTEM <i>LP 33 SERIES</i> .....	43
7.2.1	Parallel System start-up of the <i>LP 33 Series</i> .....	43
7.2.2	Parallel UPS shutdown with load transfer on manual bypass (Q2).....	45
7.2.3	Start-up following the operation on maintenance bypass (Q2).....	47
7.2.4	Shutdown of a single unit in a parallel system .....	48
7.2.5	Start-up an additional unit in a parallel system .....	49
7.2.6	Complete shutdown of a parallel system.....	50
7.2.7	Restore to normal operation after "total off" .....	51
7.2.8	Restore to normal operation after "EPO – Emergency Power Off" .....	52
<b>8</b>	<b>OPTIONS</b> .....	<b>53</b>
8.1	OPTIONS GENERAL VIEW .....	53
<b>9</b>	<b>MAINTENANCE</b> .....	<b>54</b>
9.1	GENERAL MAINTENANCE.....	54
9.2	COOLING FAN MAINTENANCE.....	54
9.3	BATTERY MAINTENANCE.....	54
9.4	SERVICE REQUIRED .....	55
<b>10</b>	<b>NOTES</b> .....	<b>56</b>
10.1	NOTES FORM.....	56

# 1 SAFETY RULES

With this document, **GE** gives to the user all the necessary information about the correct use of the UPS.

We recommend that this manual be kept next to the UPS for future references.

If any problems are encountered with the procedures contained in this manual, please contact the nearest **Service Center** before you proceed.

All UPS installation, maintenance and service work should be performed by qualified service personnel only.

The **KNOWLEDGE** and the **FULLY** compliance of the safety instructions and the warning contained in this manual are

## THE ONLY CONDITION

to avoid any dangerous situations during installation, operation, maintenance work, and to preserve the maximum reliability of the UPS system.



### NOTE !

*LP 33 Series / 30 & 40 kVA is a FCC Class A-UPS Product.*

While every care has been taken to ensure the completeness and accuracy of this manual, **GE** assumes no responsibility or liability for any losses or damages resulting from the use of the information contained in this document.

## GE

Refuses any responsibility in case of non-observance, unauthorised alterations or improper use of the delivered UPS.

## SAVE THESE INSTRUCTIONS

This manual contains important instructions for models **LP 33 Series / 10 & 20 kVA** that should be followed during installation and maintenance of the UPS and battery.

### GENERAL

- Move the UPS in an upright position in its original package to the final destination room.
- Check for sufficient floor and elevator loading capacity.
- Check the integrity of the UPS equipment carefully.  
If you notice visible damage, do not install or start the UPS. Contact the nearest Service Center immediately.
- **WARNING! RISK OF ELECTRICAL SHOCK:** Do not remove covers; there are no user serviceable parts inside.
- After switching off takes 5 minutes for the DC capacitors to discharge because a lethally high voltage remains at the terminals of the electrolytic capacitors.
- All maintenance and service work should be performed by qualified service personnel. The UPS contains its own energy source (battery).
- The field-wiring terminals may be electrically live, even when the UPS is disconnected from the utility.
- Dangerous voltages may be present during battery operation. The battery must be disconnected during maintenance or service work.
- This UPS contains potentially hazardous voltages.
- Be aware that the inverter can restart automatically after the utility voltage is restored.

### STORAGE

- Store the UPS in a dry location; storage temperature must be within -13°F (-25°C) to 131°F (55°C).
- If the unit is stored for a period exceeding 3 months, the battery must be recharged periodically (time depending on storage temperature).

### BATTERY

- The battery-voltage is dangerous for person's safety.
- When replacing the battery, use the same number, voltage (V) and capacity (Ah).
- Proper disposal or recycling of the battery is required.  
Refer to your local codes for disposal requirements.
- Never dispose of battery in a fire: They may explode.
- Do not open or mutilate battery: Their contents (electrolyte) may be extremely toxic. If exposed to electrolyte, wash immediately with plenty of water.
- Avoid charging in a sealed container.
- Never short circuit battery. When working with battery, remove watches, rings or other metal objects, and only use insulated tools.

# Safety symbols and warnings









## Safety warnings

The text of this manual contains some warnings to avoid risk to the persons and to avoid damages to the UPS system and the supplied critical loads.

The non-observance of the warnings reminding hazardous situations could result in human injury and equipment damages.

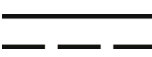
Please pay attention to the meaning of the following warnings and symbols.

Throughout this manual the following symbols are defined:

	<b>WARNING, if instruction is not followed injury or serious equipment damage may occur!</b>
	<b>CAUTION, internal parts have dangerous voltage present. Risk of electric shock!</b>
	<b>PE (Earth) – GND (Ground) PROTECTIVE GROUNDING TERMINAL: A terminal which must be connected to earth ground prior to making any other connection to the equipment.</b>
	<b>A terminal to which or from which an alternating (sine wave) current or voltage may be applied or supplied.</b>
	<b>A terminal to which or from which a direct current or voltage may be applied or supplied.</b>
	<b>This symbol indicated the word "phase".</b>
	<b>This symbol indicates the principal on/off switch in the on position.</b>
	<b>This symbol indicates the principal on/off switch in the off position.</b>





## 2 INTRODUCTION

### 2.1 GENERAL DESCRIPTION

The **LP 33 Series Uninterruptible Power Supply** (UPS) provides the energy supply for critical loads which need a reliable, continuous free from voltage disturbances and frequency fluctuations supply.

In case the *mains fails*, or it exceeds the permitted tolerances, the energy to supply the *load* is furnished by the **battery** with a backup time dependent on its capacity, until the mains recovers.

	<b>LP 33 Series</b> is a truly <i>VFI</i> double conversion <b>Uninterruptible Power Supply</b> (UPS), equipped with <i>automatic bypass</i> , where the <b>load</b> is normally supplied by the <b>inverter</b> .
	<b>LP 33 Series</b> can be configured, if chosen, for the <b>ECO Mode</b> permitting the maximum energy saving.

The main typical performances of the **LP 33 Series** system are the following:

- **VFI (Voltage Frequency Independent)** double conversion technology to provide an excellent quality power supply.
- Input power factor 0.8.
- Input current THD <10%.
- Automatic bypass and manual bypass to improve reliability and maintenance.
- Microprocessor controlled supervision.
- Dual AC inputs (optional).
- **ECO Mode** operation.
- Compact and agreeable design expressly conceived for "Office environment".
- Low level acoustic sound, 50 dB(A) (10 kVA), 55 dB(A) (20 kVA) and 61 dB (A) (30 & 40 kVA) to avoid noise to the persons operating in the same environment.
- Multi-language LCD screen.
- Total battery management: **SBM** (Superior Battery Management)
- High battery capacity, 22 minutes (10 kVA), 9 minutes (20 kVA), 29 minutes (30 kVA) and 19 minutes (40 kVA), with battery housed in the UPS cabinet.
- Wide rectifier input voltage tolerance: 152 ÷ 240 VAC (phase – phase).
- Wide rectifier input frequency tolerance: +/-10% (54 ÷ 66 for 60 Hz).
- **RPA** (Redundant Parallel Architecture) up to 4 units.
- **GE Connectivity**.
- Compliance with UL standard 1778.

# 3 DESCRIPTION

## 3.1 BLOCK DIAGRAM AND MAIN ELEMENTS DESCRIPTION

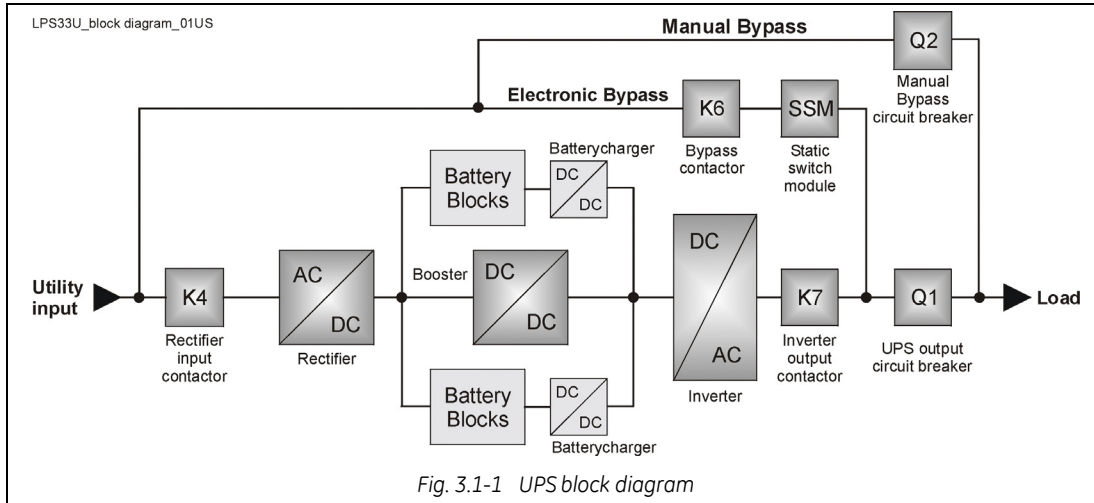

The Uninterruptible Power Supply System **LP 33 Series / 30 & 40 kVA** can be divided into the following main elements:

### Electronics

The UPS is designed with a microprocessor-controlled supervision and diagnostic system. Communication between user and UPS is achieved by the **front panel** consisting of an LCD screen, displaying the operation modes, the measurements and the events / alarms.

### Rectifier

The **rectifier** converts the 3-phase mains voltage into a controlled and regulated DC-voltage, in order to supply power to the **booster**, and to charge the **battery** through the **battery-charger**.

### Inverter

The **inverter** converts the DC voltage into a three-phase AC-voltage with constant amplitude and frequency, which is completely independent from the AC-input voltage.

### Automatic Bypass

The **automatic bypass** consists of a static semiconductor-switch (SSR: *Static Switch Relay*), used to provide an uninterrupted transfer of the **load** from **inverter** to **mains** when operating in **VFI Mode**. If chosen the **ECO Mode**, the SSM transfer the **load** from **mains** to **inverter** in case the utility fails.

### Back-Feed Protection

All **LP 33 Series** UPS's are equipped with an automatic system for the protection against voltage back feeding towards Utility, through the Bypass (Applied Standard IEC 62040-1).

This protection works automatically by opening **contactor K6** (in series with the thyristors of the static switch) and eventually **K7**, and acts in case of internal defects of the system, or due to wrong manipulations on the **maintenance bypass Q2**.

### Manual Bypass

The **manual bypass** consists of a pair of manual switches **Q1** and **Q2**, which allow the isolation of the UPS from the **load**, while still supplying the **load** with power directly from the **mains**.

### Battery

The **battery**, normally stored by the **battery-charger**, supplies the DC energy to **inverter** in the event of **mains** failure.

## 3.2 OPERATION MODES

This section describes the different possible operation modes of the UPS explaining the function of the main modules of the UPS.

### VFI (Voltage Frequency Independent) Mode operation

Under normal conditions the **load** is permanently powered by the **inverter** with constant amplitude and frequency.

The **rectifier**, powered by the **mains**, supplies the **inverter** and the **battery-charger** keeps the **battery** fully charged.

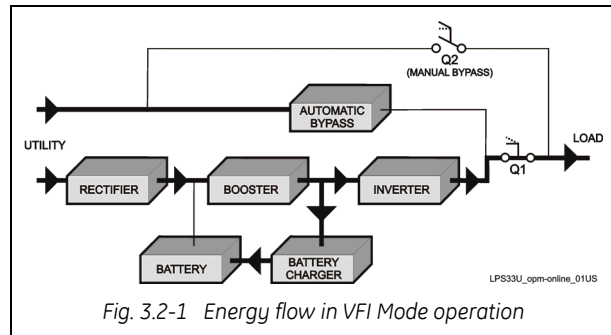

The **inverter** converts the DC voltage in a new AC sine wave voltage with constant amplitude and frequency independently from the input **mains** power.

### ECO Mode operation (Intelligent Energy Management)

When the **ECO Mode** is selected, and the **mains** power is available, the **load** is normally powered through the **automatic bypass**.

When the mains voltage is detected out of the prescribed tolerances, the **load** is automatically transferred to the **inverter**.

When the **mains** recovers, the **load** returns to the **automatic bypass** after a variable time defined by the control unit.

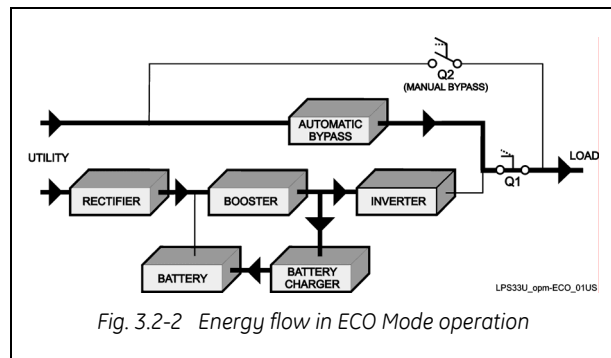

The **ECO Mode** can be configured directly by the user for higher efficiency, considering the **mains** reliability and criticality of the **load**.

The selection between the two operation modes "**VFI Mode** and **ECO Mode**", or switching between operation modes at required time, can be done through the UPS **control panel** (see Section 6.3.1-5).

**RPA**

Redundant Parallel  
Architecture

**In case of parallel system**

*ECO Mode cannot be enabled for RPA Parallel System.*

**Attention:** *A single unit equipped with a RPA - Parallel board, must be considered as parallel, thus disabling ECO Mode.*

## Automatic bypass operation

In **VFI** (Voltage Frequency Independent) operation mode, the **load** is permanently supplied by the **inverter** but, in case of trouble on the **inverter**, or when overload or short-circuit on the output occur, if the **mains** voltage do not exceed the admitted tolerances, the **load** is instantly transferred to the **mains** through the **automatic bypass**, taking advantage of the higher short circuit power.

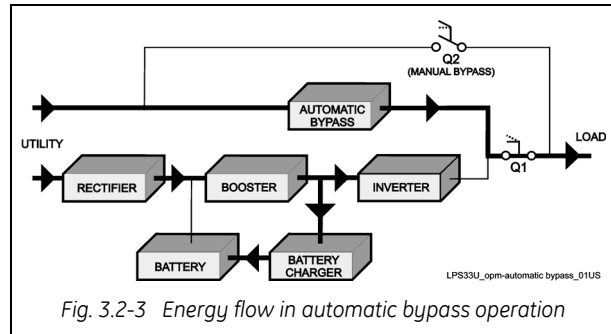

Fig. 3.2-3 Energy flow in automatic bypass operation

When the **inverter** recovers, the **load** will be re-transferred automatically to the **inverter**.

## RPA

Redundant Parallel Architecture

### In case of parallel system

Each unit has its own bypass.

All the bypasses in the system work together, their control being managed in the same manner by all units.

The units are continuously exchanging information before taking such decision.

In case the inverter of one unit fails, its bypass remains operating.

It is excluded only if the unit is separated from the common bus by opening its output switch **Q1**.

## Mains recovery operation

As soon as the **mains** recovers, the **rectifier** starts up automatically supplying the **inverter** and the **battery-charger** recharges the **battery**.

In case the **inverter** has been shut down following a complete discharge of the **battery**, when the **mains** recovers the system start up automatically.

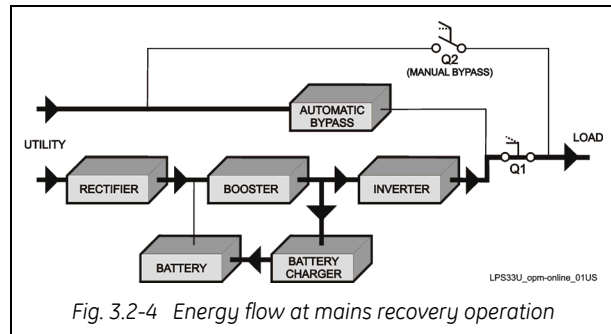

Fig. 3.2-4 Energy flow at mains recovery operation

When the energy stored in the **battery** is sufficient to ensure a minimum time of operation with the actual load, in case of a future **mains** failure, the **load** will be retransferred to **inverter** (if selected **VFI Mode**).

## RPA

Redundant Parallel Architecture

### In case of parallel system

When the AC input power recovers, **the rectifiers will start up sequentially** according to their number in the parallel system **in order to avoid an initial inrush current**.

**The inverters will start up automatically**, but only when the battery has recharged enough for a **minimum runtime** with the present load.

**When enough inverters to supply the load have been restarted, the load will be transferred from the automatic bypass back to the inverter bus-bars.**

## Manual bypass operation

The **manual bypass** circuit consisting of **Q1** and **Q2** manual switches, permits the transfer of the **load** directly to the **mains** without interruption, leaving the UPS galvanically separated from the output **load**.

This type of operation is normally used when the UPS system must be completely turned off for maintenance or reparation.

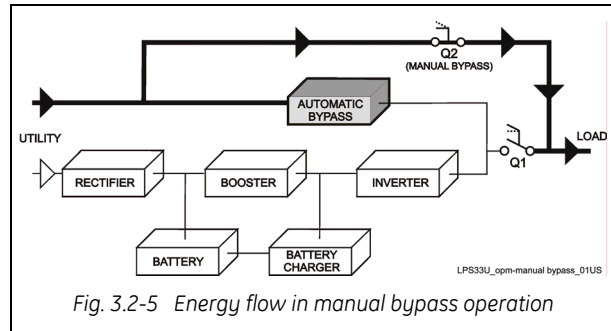

## Mains failure operation

In the event of a **mains** power failure, the **rectifier** and the **battery-charger** turn OFF, while the **inverter** continues to supply the **load** without interruption using the energy stored in the **battery**.

During the **battery** discharge, the LCD screen displays the remaining autonomy, based on the **battery** capacity and the applied **load**.

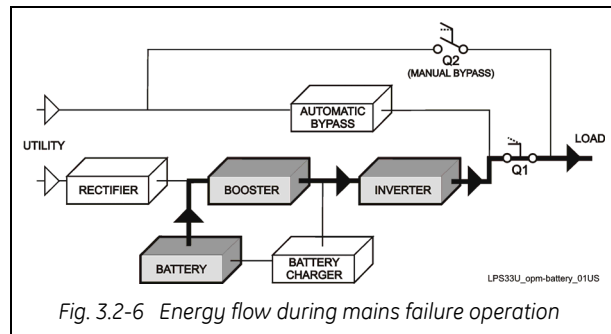

In the event of an extended mains failure, before the **battery** is fully discharged, the alarm "**stop operation**" warns the user that the UPS will start the shutdown procedures when the indicated time expired (normally 3 minutes).

# RPA

Redundant Parallel  
Architecture

## In case of parallel system

### With parallel system for power capacity:

- With the **bypass mains power available** as the warning "battery low" occurs on one unit, after timeout (selectable) the load is transferred to mains.
- With **missing bypass mains power** as the warning occurs on one unit, the system starts the timeout (selectable) of "Stop operation" and then the output load shuts down.

### With redundant parallel system:

- As the warning battery low occurs on one unit unnecessary to support the present load, after timeout (selectable) this unit shuts down and the load is shared between the other units. As the warning occurs on one unit necessary to support the present load, the system starts the timeout (selectable) of "stop operation" and then the output load shuts down.

### 3.3 RPA PARALLEL SYSTEM

The **RPA** (Redundant Parallel Architecture) allows to extend the unit to a parallel system with 2, 3, or 4 units **LP 33 Series** connected on the same bus, which ensure the highest reliability rate and increase the power availability.

#### **Parallel system for power capacity**

Two or more units can be paralleled in order to achieve output power superior to the maximum power delivered by a single UPS unit.

The maximum total load shared between the  $n$  parallel units can achieve the 100% of the installed nominal power system.

In the event of one unit fails, the load will be suddenly transferred to the mains by the bypass.

#### **Parallel system for redundancy**

The parallel system can be defined redundant only in case the nominal power rating of  $n-1$  units of  $n$  parallel units is sufficient to supply the required load power.

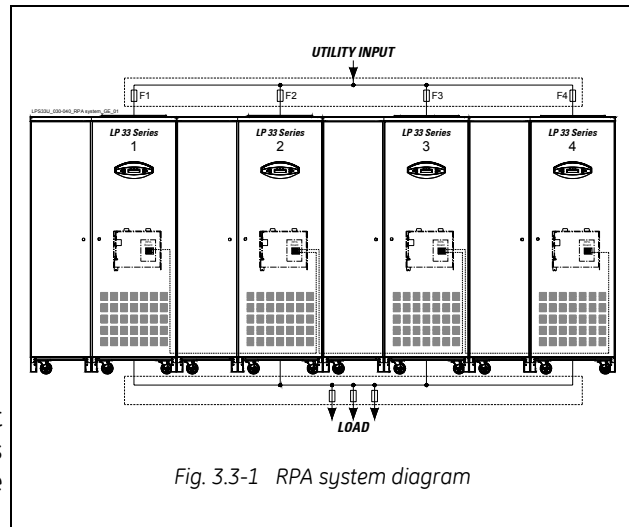

Fig. 3.3-1 RPA system diagram

The load in a *parallel redundant system*, is equally shared by  $n$  units connected on the output bars. Should one of the parallel units trip off-line, the remaining ( $n-1$ ) units will share the load maintaining the applications protected by inverter until the normal situation restores.

#### **Load sharing between parallel units**

The control bus exchanging the data between the microprocessors of the paralleled units provide for a constant proportional load sharing in every load condition.

#### **Management and synchronization of the parallel system**

All the units are identical without master and slaves.

One unit is arbitrarily selected as the reference (the first unit connected on power bus) being this unit the first synchronized with the mains voltage, and all the other units synchronize with the first one.

In case the reference unit fails or it is excluded from the parallel power bus any other unit will take over the reference role.

The AC input power source of all the bypasses must be the same for all the units of the parallel system excluding any phase shift between them.

#### **Control bus of the parallel system**

A high-speed serial bus, guarantees communication, synchronization and load sharing between the UPS modules.

Each module controls its own function, while the Master (each unit can be Master) controls and commands the status of the system.

	<p><b>NOTE !</b></p> <p>The parallel system exclude more rectifiers connected on common battery. No transformers, fuses or automatic circuit breakers should be inserted between the unit's output and the load common bus bars.</p>
---	--

### 3.4 UPS PARALLELED ON THE SAME BATTERY

**NOTE !**

A parallel system with a *Common Battery* for two or more *UPS*, requires a particular installation and adequate setting of some parameters, (accessible only through password), and can therefore only be done by a qualified GE engineer.

Usually each *UPS Unit* runs with its own *Battery*.

In case of parallel units running with a *Common Battery* (max. 4 *UPS* - see Fig. 3.4-1), the sharing circuit between the individual *UPS* is integrated in the communication bus of the system in order to assure an equal sharing of the *Rectifiers* output currents.

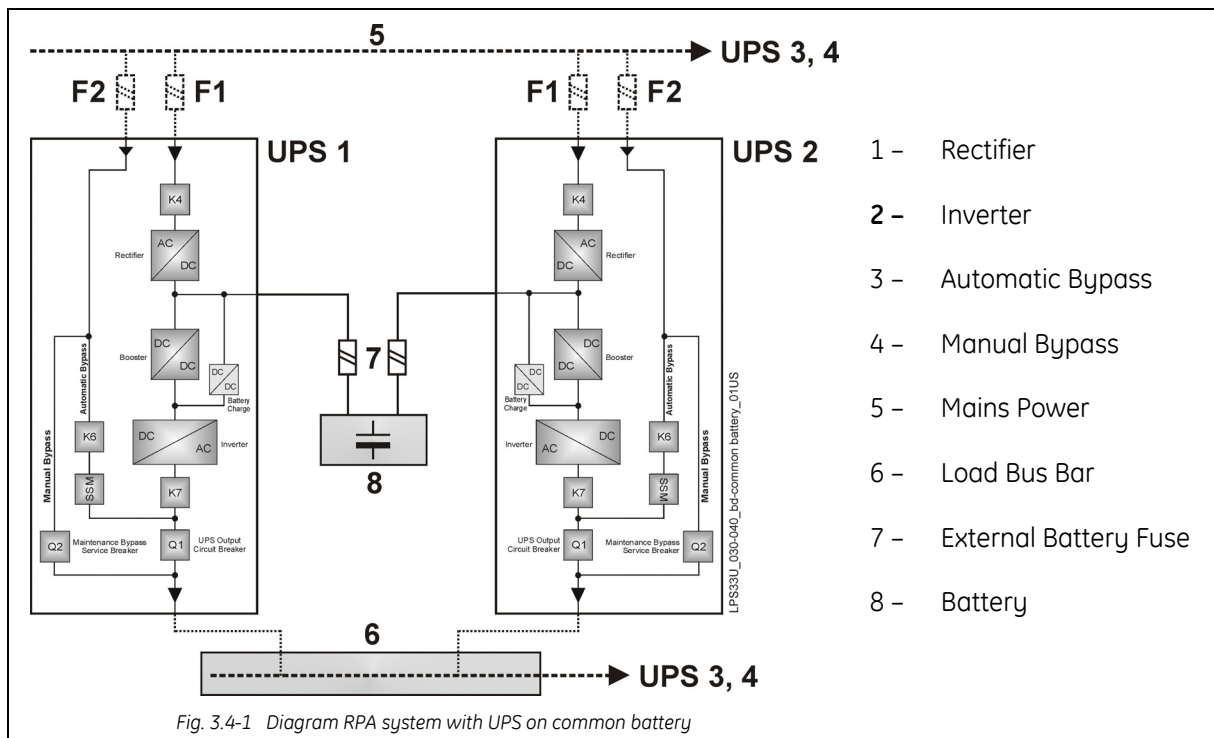

#### Pay attention to the following recommendations:

- The units delivered for this functioning mode needs a special parameters setting, so they must be prepared in advance before the installation.
- The installation must be performed only with the UPS system completely shut down.
- The AC *Rectifiers* input power (5) must be the same, with clockwise phase rotation for each unit.
- Each *Rectifier* must be set for the same floating DC voltage and the same *Battery* current limitation.
- It is mandatory to install the fuses / MCB (7) on each line connecting the *Rectifiers* to the common *Battery* for maintenance / safety reasons (see Section 4.7.2).
- In case a unit must be powered down for maintenance, switch-OFF the concerned unit before open the DC fuses / MCB on the *Battery* line (7).
- If an emergency generator set supplies the UPS, and the free contact "Generator ON" is connected to the *Customer Interface*, connect a separate NO free contact on each parallel unit.
- Do not connect the temperature sensor for automatic *battery floating voltage* compensation.
- Do not enable the function *Boost charge*.

### 3.5 SERVICE AND TECHNICAL SUPPORT

For any request of technical support please contact the supplier who provided the system.

Stamp of your Dealer or local responsible of the Technical Assistance  
(see page 3)

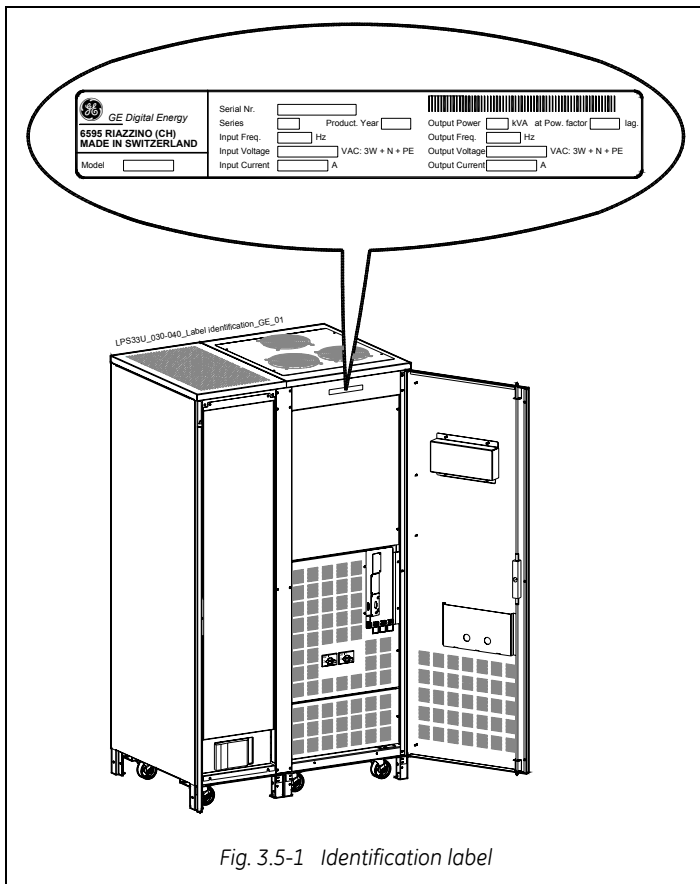

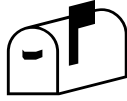

Fig. 3.5-1 Identification label

The requested data permitting to identify your UPS are marked on the **identification label** fixed on the front of the cabinet, behind the lower front door.

For fast and efficient Technical Support solutions, please mention the data marked on the identification label.



### 3.6 RECYCLING AT THE END OF SERVICE LIFE



**NOTE !**

This product has been designed to respect the environment, using materials and components respecting eco-design rules.

It does not contain CFCs (Carbon Fluor Clorid) or HCFCs (Halogen Carbon Fluor Clorid).



*GE, in compliance with environment protection recommends to the User that the UPS equipment, at the end of its service life, must be recovered conforming to the local applicable regulations.*



**WARNING !**

Leads contained in the batteries is a dangerous substance for the environment, therefore it must be correctly recycled by specialised companies!

# 4 LAYOUT

## 4.1 LAYOUT LP 33 Series / 30 & 40 kVA

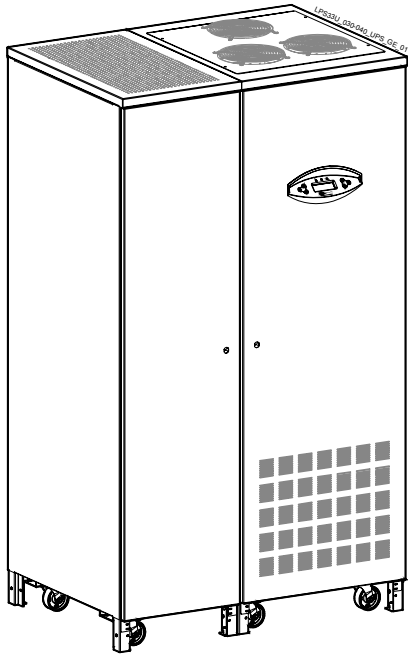

Fig. 4.1-1 General view

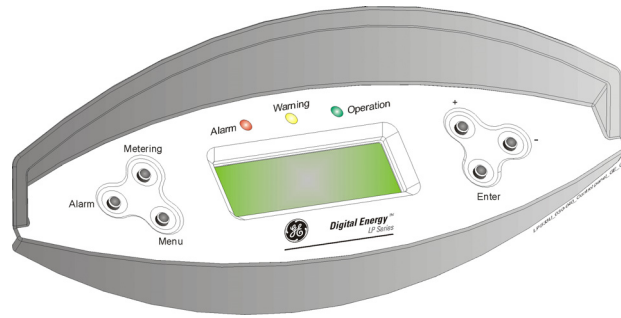

Fig. 4.1-3 Control panel

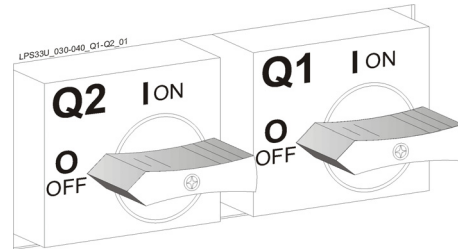

Fig. 4.1-4 Q1 & Q2 switches

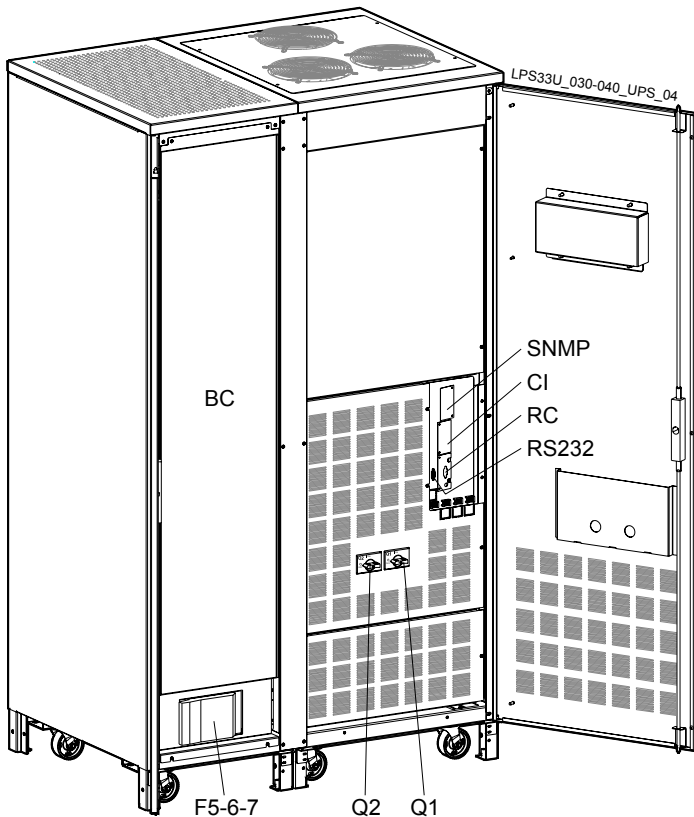

Fig. 4.1-2 General view with open door

- BC** Battery cabinet
- CI** Customer Interface Board (optional)
- F5-6-7** Battery fuses
- Q1** UPS output switch
- Q2** Manual bypass switch
- RC** Relay card
- SNMP** Advanced SNMP Card (optional)
- RS232** Serial port RS232

# 5 SYSTEM HANDLING

## 5.1 CONTROL PANEL

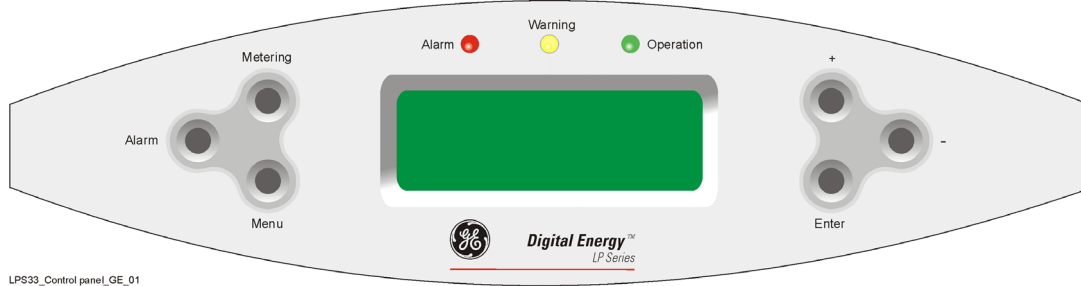

Fig. 5.1-1 Control panel

- LCD screen** Shows the UPS system data, events messages and UPS setting. The data is displayed on 4 rows, 20 characters each, allowing the operator to select between 7 languages: *English, German, French, Spanish, Italian, Finnish or Polish*. If there is no keypad activity during 1 minute the LCD screen will return to default screen.
- Metering** Shows electric parameters, operating statistics and some information screens (see Section 6.1).
- Alarm** Shows in chronological order, all the events occurred (alarms, messages, commands, handling, etc.) and resets general alarm / buzzer (see Section 6.2).
- Menu** Allows the user to adapt certain features of the UPS to his needs, to reset the command *total off*, to test the *LEDs panel*, and to command the *inverter ON/OFF* (see Section 6.3).
- +** Scroll to following screen.  
Entering in *PARAMETER MENU/USER*, allows to select the horizontal editable position.
- Entering in *Alarm* and *Metering*, scroll to previous screen.  
Entering in *menu* allows to select the row including the needed command.
- Enter** Confirms the selected command.  
Entering in *PARAMETER MENU/USER* allows the user to change the parameters.
- LED Alarm (red)** It warns about the imminent inverter stop and the consequent load shutdown as result of:
- The *battery* is fully discharged and the *load* cannot be transferred on *mains* (default parameter = 3 min.).
  - Overtemperature (default = 3 min.) or overload condition (125%-10 min, 150%-1 min.) and the *load* cannot be transferred on *mains*.
- LED Warning (yellow)** When blinking, it means the UPS is in alert condition with the buzzer sounding. The *yellow LED* will remain lit after pressing the key *Alarm*. It remains lit also when the output switch Q1 is open or battery disconnected.
- LED Operation (green)** When lit, it means the UPS is correctly operating and the *load* is powered by the *inverter*. When blinking, it means *SERVICE REQUIRED*

## 5.2 COMMAND PUSH BUTTONS AND SWITCHES

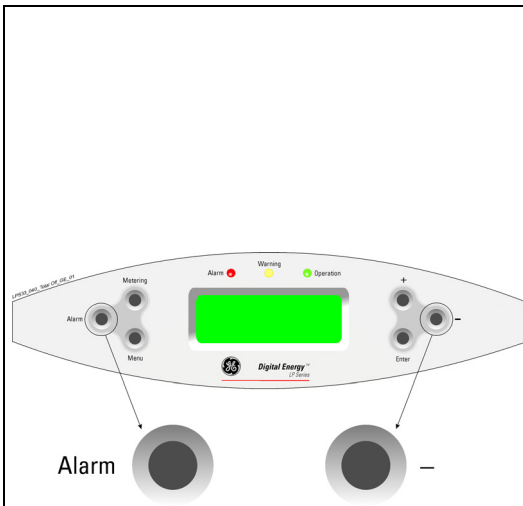

Fig. 6.2-1 Command total off

### **total off**

Press simultaneously the keys “**Alarm**” and “**-**” on the panel.

This will cause the opening of all *contactors* (K4, K6 and K7), shutdown of *booster*, *Inverter*, *battery-charger* and *SSM*.

**RPA**

Redundant Parallel Architecture

In a parallel system pressing **total off** on one unit all the units will shut down.



### **NOTE !**

Using the command *total off*, the *load* will be immediately powered down.

To restart the unit, command **total off** must be restored entering the screen

*MENU/RESET TOTAL OFF*

LAMP TEST

RESET TOTAL OFF \*

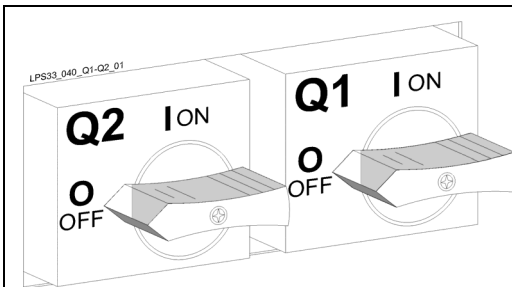

Fig. 6.2-2 Q1 & Q2 switches

**Q1 - UPS output switch**

**Q2 - Manual bypass switch**



### **NOTE !**

Do not switch ON Q1 and Q2 with *Inverter ON*.



### **NOTE !**

Mains failure of long duration or low Battery voltage will cause the automatic shutdown of the UPS, thus preventing damage to the Battery.

## 6 LCD SCREEN

Shows the UPS system data, events messages and UPS setting.

The data is displayed on 4 rows, 20 characters each, allowing the operator to select between 7 languages: **English, German, French, Spanish, Italian, Finnish and Polish**.

If there is no keypad activity during 1 minute the LCD screen will return to default screen.

### 6.1 METERING SCREENS (Metering)

This menu allows, when the keypad *Metering* is pressed, to show on the LCD panel a series of screens containing metering information about AC and DC parameters.

LP 33 40kVA P1  
APPLICATION ON UPS  
= 70%  
SERVICE REQUIRED

1. UPS family, nominal rating and for *RPA*: P + No. UPS.
2. Load status: application on UPS, on utility, supply off, manual bypass (appl. on manual dev.) and **ECO Mode**.
3. The load amount as a percentage of the nominal load (referred to the most loaded phase).
4. The signalling, combined with the green *LED Operation* blinking, is done only in case the respective parameter (protected by password) has been enabled. See *Section 8.4*.

Udcp=215V Udcn=215V  
Ubp=164V Ubn=164V O  
Charge Level = 100%  
Autonomy = 15min

1. Booster DC voltage + pole (*Udcp*) and – pole (*Udcn*).
2. Battery DC voltage + pole (*Ubp*), – pole (*Ubn*) and the status *SBM* (Superior Battery Management).

The functionality of *SBM* can help to reduce the Battery recharging time, and improve the lifetime of the Battery.

Beside the indication of the Battery voltage on the display, a letter shows, according to the table below, the operational status of *SBM*:

Sigle	Status of charger	Charter voltage	Description
<b>O</b>	OFF	0 VDC	Battery open circuit voltage
<b>T</b>	ON	Boost (176 VDC)	Boost charge with new Battery
<b>F</b>	ON	Floating (164 VDC)	Battery charged
<b>L</b>	ON	Floating (164 VDC)	Normal charge
<b>B</b>	ON	Boost (176 VDC)	Boost charge
<b>E</b>	ON	Boost (179 VDC)	Battery equalization

Access to the Parameters for setting the *SBM* mode is password protected.  
Please call your *Service Center*.

3. Battery charge level.
4. Estimated battery backup time with actual load.

MAINS  
f=60.0Hz  
U1=120V U2=119V  
U3=121V

1. Mains input voltage information screen.
2. Mains input frequency.
3. Mains line voltage L1 (A) and L2 (B) phases.
4. Mains line voltage L3 (C) phase.

RECTIFIER  
f=60.0Hz  
U1=120V U2=119V  
U3=121V

1. Rectifier input voltage information screen.
2. Mains input frequency.
3. Input line voltage L1 (A) and L2 (B) phases.
4. Input line voltage L3 (C) phase.

INVERTER: U1=120V  
U2=120V U3=120V  
Frequency = 60.0Hz  
Synchronized

1. Inverter voltage information screen.
2. Output inverter line voltage L1 (A), L2 (B) and L3 (C) phases
3. Output frequency.
4. Synchronization status inverter with respect to mains.

LOAD ON PHASE  
U1=120V I1=56A 50%  
U2=120V I2=50A 45%  
U3=120V I3=61A 55%

1. Load on output phases information screen.
2. Voltage, current and load percentage phase L1 (A).
3. Voltage, current and load percentage phase L2 (B).
4. Voltage, current and load percentage phase L3 (C).

MISCELLANEOUS  
Battery Temp. = +25°C  
UPS Oper Time= 450h  
INV Oper Time= 430h

1. Screen informing about the battery and time of operation.
2. Battery temperature.
3. Operating time (CPU powered) for the UPS (hours).
4. Operating time with inverter supplying the load (hours).

MAINS FAULTS STAT.  
Minor = 100  
Major = 150  
Overloads = 30

1. Screen informing about the quality of the input power.
2. The quantity of bypass mains out of tolerance faults.
3. The quantity of rectifier mains out of tolerance faults.
4. The total number of detected output overloads.

IDENTIFICATION  
LP 33 40kVA P1  
SW Version: x.x  
S/N: Q0040-0105-0001

1. Screen containing the data identifying the unit.
2. UPS family, nominal rating and for RPA: P + no. UPS.
3. The software version implemented on the control board.
4. The serial number of the unit.

ECO Mode RATE 100%  
NR FAST TRANSIENT  
<2ms >2ms >5ms >10ms  
25 10 7 3

- Screen containing the statistic evaluation in % (100= good; 0= bad) of the utility, for the *ECO Mode* operation.
4. The number of fast transients occurred on the bypass utility on the last seven days.

## 6.2 EVENT SCREENS (Alarm)

Each of the following listed **alarms** or **messages** can be displayed on the LCD screen or transmitted to a PC through the serial port *RS232* or the *SNMP card* (optional).

Entering the **Alarm** mode, the *LCD screen* displays a sequence of screens corresponding to the last 256 alarms & events, each screen indicating:

```
01.01.2005  12:15:45
NR=255  Status=A588
4580: INVERTER AND
MAINS SYNCHRONIZED
```

1. The exact date and time when the event occurred.
2. The number (255 being the most recent) and status code.
3. The software version implemented on control board and explicit text description of the event.

### 6.2.1 Alarms list

Are defined **alarms**: all the events which activate the *LED Warning* (yellow) and the *buzzer* in order to alert the user about an abnormal situation.

Code	Alarm	Meaning
4000	SETUP VALUES LOST	Parameters are lost and have been replaced with default values.
4001	REGULATION BOARD FAILURE	Voltage supply +/-15 VDC has been detected out of tolerance on the P1 – Control board or the programmable circuits are defective.
4004	UPS FAILURE	The master unit detected the slave unit missing on the communication bus even though switch Q1 is still closed.
4100	RECTIFIER FUSES FAILURE	The trip indicator mounted on rectifier input fuses indicates a blown fuse. The rectifier is turned Off (K4 open) and the load will be supplied by the battery.
4102	K4 CLOSING FAILURE	K4 not closed despite a closing command being done. The rectifier is switched OFF.
4103	K4 OPENING FAILURE	K4 not open despite an opening command being done. The rectifier is switched OFF.
4110	RECTIFIER MAINS OUT OF TOLERANCE	Rectifier input mains has been detected out of tolerance (voltage, frequency or phase).
4115	LOW BATTERY VOLTAGE	The battery has been discharged and reached “stop operation” time-out (default 3 minutes), the inverter will be shut down. It restarts automatically only when the battery has recovered energy to ensure min. a “stop operation” time to the actual load.
4116	HIGH BATTERY VOLTAGE	Dangerous high UDC-Voltage. Causes Inverter shutdown. Inverter restarts automatically after return to normal floating voltage.

Code	Alarm	Meaning
4118	BATTERY FAULT	During battery test the DC voltage falls under the critical level. If the boost voltage has not been reached within 24 hours, then the charge voltage returns to floating voltage. Battery test is stopped.
4130	TURN ON RECT. OR SHUTDOWN UPS	Rectifier and inverter are OFF. The DC power supply is discharging the battery slowly. Rectifier must be restarted or battery must be disconnected in order to avoid damages.
4140	RECTIFIER CONTROL FAILURE	Rectifier voltage hasn't reached the set value. Probably fault on regulation loop. The DC capacitors are not equally charged (more of 50 VDC of difference). The rectifier is switched OFF.
4301	INVERTER FUSES FAILURE	Inverter output fuses blown. Signaled by electronic detector. Inverter can be started manually after replacement of fuses.
4304	K7 CLOSING FAILURE	K7 not closed despite a closing command being done. Signaled by auxiliary contact. Load will be supplied by mains.
4305	K7 OPENING FAILURE	K7 not open despite an opening command being done. Signaled by auxiliary contact. Load will be supplied by mains.
4312	INV. VOLTAGE OUT OF TOLERANCE	Inverter output voltage is out of the tolerances defined in respective parameter ( $\pm 10\%$ ). Inverter is switched OFF.
4320	ISMAX DETECTION	Detection of inverter bridge (Is) current limitation cause inverter OFF and automatic restart (message 320). After 3 times inverter switches OFF for persistent Is max detection in time. Inverter switch OFF, and it can be restarted manually.
4340	INVERTER CONTROL FAILURE	The slave oscillator is not synchronized with the master, thus causing the shutdown of it's inverter.
4347	OSCILLATOR FAILURE	Auto calibration of the Inverters free-run frequency was not possible. The oscillator frequency of this unit is out of tolerance.
4402	RECTIFIER CANNOT BE TURNED ON	The rectifier cannot be turned on because the DC link voltage has not reached the requested value.
4404	K6 CLOSING FAILURE	K6 not closed despite a closing command being done. Signaled by auxiliary contact. The load cannot be supplied by electronic bypass.
4405	K6 OPENING FAILURE	K6 not open despite an opening command being done. Signaled by auxiliary contact.
4410	BYPASS MAINS OUT OF TOLERANCE	The mains bypass voltage is out of the tolerances ( $\pm 10\%$ ). K6 opens, synchronization with mains is inhibited and transfer to mains is blocked.



Code	Alarm	Meaning
4520	NO INVERTER POWER	The load supplied by utility is over 100%. The load remains blocked on utility as long as alarm overload is active.
4530	LOAD LOCKED ON MAINS	Load is locked on mains because 3 transfers on mains have been detected in a short time (default 30 seconds). Transfer will be free again after a time defined by respective parameter (default 30 seconds).
4531	LOAD ON MAINS BY ERROR DETECTOR	Load is transferred to mains because the error detector detected a disturbance on the output voltage.
4563	EMERGENCY OFF ACTIVATED	Alarm after detection of an Emergency Off from an external safety device connected on Customer Interface. Consequently K4, K6 and K7 open and shut down inverter, booster and rectifier.
4570	OVERLOAD	The UPS-System is in an overload condition >125% on inverter, or >150% on mains. A sequence of "stop operation" starts. Time out depending on load quantity.
4571	OVERLOAD: LOAD ON MAINS	With mains bypass supply available and load >115%, the load is transferred on mains. Load will be transferred again automatically on inverter when load will be <100%.
4581	INVERTER AND MAINS NOT SYNCH.	The voltages of mains and inverter are not synchronized, which causes the opening of K6.
4697	BATTERY OVERTEMPERATURE	The battery temperature exceeds the value inserted in parameter. Disabled with parameter (service only).
4698	BATTERY POWER INSUFFICIENT	In case of utility failure, with the actual load, the autonomy time would result below "stop operation" time (default 3 minutes).
4700	DC LOW	Battery voltage is at the lowest limit. Shutdown of inverter until the battery voltage reaches the value in respective parameter.
4900	LOAD LOCKED ON INVERTER	The load is locked on Inverter following 3 load transfers within 30 seconds. After time out of the value in respective parameter (default 30 seconds), bypass will be free.
4955	OVERTEMPERATURE	An overtemperature condition has been detected on inverter. Elapsed "stop operation" time, inverter shutdown. With mains available, load is transferred on mains.
4998	LOAD OFF DUE TO EXTENDED OVERLOAD	Load Off after time-out of "stop operation" for overload on inverter or bypass (time depending on the % of overload).
4999	LOAD OFF DUE TO UBATT OR TEMP.	Load Off after time-out of "stop operation" with missing mains due to battery low voltage or overtemperature condition.

## 6.2.2 Messages list

Are defined **messages**: all the recorded events which are referred to the operation status coherent with the normal situation of the UPS.

Code	Message	Meaning
4111	RECTIFIER MAINS OK	Rectifier input mains is again within the admitted tolerance (voltage, frequency and phase).
4114	UPS SHUTDOWN (LOW BATT VOLTAGE)	The UPS is in Load OFF status, resulting in Battery supply for the power supply. Should the Battery voltage decrease to a value below of the one set in a parameter, then power supply will shutdown to avoid damage to the Battery
4119	BATTERY TEST STARTED	Start of manual or automatic battery test. Rectifier output voltage is decreased to the value defined by respective parameter.
4120	BATTERY TEST STOPPED	End battery test. End of manual or automatic battery test. Rectifier output voltage is restored to floating voltage.
4141	ISMAX DETECTION BOOSTER	Detection of persistent booster (Is) current limitation.
4161	RECTIFIER ON	Rectifier received the command to switch ON.
4162	RECTIFIER OFF	Rectifier received the command to switch OFF for: input mains out of tolerance / EPO / UDC max.
4163	GENERATOR ON	Customer Interface (X1 / 11, 22) received a Gen set ON signaling. Operating mode dependent on setting of respective parameters.
4164	GENERATOR OFF	Customer Interface (X1 / 11, 22) received a Gen set OFF signaling. Function bypass enabled dependent on setting of respective parameter.
4302	INVERTER CANNOT BE TURNED ON	Inverter cannot be switched on because one of the following conditions are still present: <ul style="list-style-type: none"> <li>• Overtemperature;</li> <li>• Low battery voltage;</li> <li>• Inverter fuses;</li> <li>• Overload;</li> <li>• K7 opening failure;</li> <li>• High battery voltage;</li> <li>• DC low;</li> <li>• EPO (Emergency Power Off).</li> </ul>
4303	INVERTER CANNOT BE TURNED OFF	Inverter cannot be switched OFF, because the load cannot be transferred on mains (voltage out of tolerance, not synchronizing, bypass blocked).
4361	INVERTER ON	The command to start the inverter has been activated on the control panel.

Code	Message	Meaning
4362	INVERTER OFF	The command to switch OFF the inverter has been done by the control panel or automatically for alarm detection.
4411	BYPASS MAINS OK	Bypass input mains is again within the admitted tolerance (voltage, frequency and phase).
4500	COMMAND LOAD OFF	Disconnection of the load by opening K4, K6 and K7 for: EPO / Total Off / Overload / Stop operation.
4521	NO BYPASS POWER	With the load supplied by electronic bypass, a mains failure or K6 opening occurred.
4534	MULTIPLE LOAD TRANSFER	2 transfers inverter-mains have been detected in a short time, defined by respective parameter (default 30 seconds).
4535	BYPASS LOCKED	Transfer on mains not enabled due to settings of respective parameters. Contactor K6 is open.
4536	BYPASS FREE	Settings of respective parameters enable bypass transfer on mains. Contactor K6 can be closed.
4561	TOTAL OFF	Push-button Total Off behind the front door has been pressed, with the output circuit breaker Q1 closed.
4562	DETOUR ON	The auxiliary contact indicates that manual bypass Q2 has been closed.
4564	DETOUR OFF	The auxiliary contact indicates that manual bypass Q2 has been opened.
4567	COMMAND LOAD ON MAINS	The control unit received a command to transfer the load on mains.
4568	COMMAND LOAD ON INVERTER	The control unit received a command to transfer the load on inverter.
4572	NO MORE OVERLOAD	End of the overload condition previously detected with alarm 4570.
4580	INVERTER AND MAINS SYNCHRONIZED	The voltages of inverter and mains bypass are synchronized.
4582	COMMAND NOT TO SYNCHRONIZE	Command not to synchronize with mains has been done for: mains bypass out of tolerance (4410) or setting respective parameters.
4583	COMMAND TO SYNCHRONIZE	Command to synchronize with mains has been done for: mains BP OK (4410) or setting respective parameters.
4600	COMMAND UPS ON	The <i>ECO Mode</i> function has been disabled or the programmed time is expired. The UPS returns to <i>VFI Mode</i> supplying the load normally by inverter.
4601	COMMAND UPS STAND BY	The function <i>ECO Mode</i> is enabled, and according to the time program the UPS will run in <i>ECO Mode</i> , supplying the load normally by mains.

Code	Message	Meaning
4602	Q1 OPEN	The auxiliary contact indicates that the output switch Q1 has been opened.
4603	Q1 CLOSED	The auxiliary contact indicates that the output switch Q1 has been closed.
4699	BATTERY TEST IMPOSSIBLE	Not possible to start battery test (it is postponed) for: <ul style="list-style-type: none"> <li>• No mains rectifier or bypass;</li> <li>• Battery not fully charged;</li> <li>• Load is below 10% or above 80%.</li> </ul>
4763	REMOTE CONTROL ON	Inverter can be started or shutdown by remote control. Commands source can be chosen depending on the value of respective parameter (password required): 0 = Only local panel. 1 = Only serial port on CI (TLC). 2 = Both.
4764	REMOTE CONTROL OFF	Inverter can be started or shutdown by remote control. Commands source can be chosen depending on the value of respective parameter (password required): 0 = Only local panel. 1 = Only serial port on CI (TLC). 2 = Both.

### 6.2.3 Event report LP 33 Series

In case of failure or malfunction, before calling the nearest **Service Centre** please note the most important identification data of your UPS and the most recent events displayed.

In order to make the diagnosis easier for our **Diagnostic Centre** we suggest you make a copy of this page, fill it in with the requested data, and send it by fax.

<b>LP 33 Series</b>
---------------------

User: .....

.....

.....

.....

**LP 33 Series / ..... kVA**

UPS No.: ..... - ..... - .....      Series: .....

Responsible: .....

Date: ..... / ..... / .....      Signature: .....

Event No.	Code	Status	Date	Hour
255				
254				
253				
252				
251				
250				
249				
248				
247				
246				
245				
244				
243				
242				
241				
240				
239				
238				
237				
236				
235				
234				
233				
232				
231				
230				

*Description of repair action taken:*

.....

.....

.....

.....

.....

*Actual situation:*

.....

.....

.....

.....

.....

*Remarks:*

.....

.....

.....

.....

.....

## 6.3 MENU SCREENS (Menu)

Pressing the *menu* keypad a series of screens will be displayed, permitting the user to set some functions of the UPS, to restore the command **total off**, to perform the **LEDs TEST**, and to switch the **inverter ON/OFF**.

LP 33 40kVA P1  
UPS ON

1. UPS family, nominal rating and for RPA: P + No. UPS.
2. The operating mode of the UPS (UPS ON/OFF).

COMMAND MENU  
INVERTER ON \*

1. Screen inverter command.
2. Inverter ON.
3. Inverter OFF.  
(The visualization of \*, indicates the Inverter status).

LAMP TEST  
RESET TOTAL OFF \*

1. Signaling LEDs test and buzzer test.
2. Restore the output supply following the command *total off* (the asterisk \* beside the text means that the command *total off* has been activated with Q1 closed).

PARAMETER MENU  
LEVEL 1: USER  
LEVEL 2: SERVICE

1. Screen parameters set-up for user and service.
3. Level 1: this first level not protected by password allows the user to modify some parameters of the UPS (see *Section 6.3.1*).
4. Level 2: access protected by password reserved for service engineers.

ALARMS  
UPS FAILURE  
CALL SERVICE

1. Screen indicating the presence of alarm condition and the consequent operation mode.
2. UPS status: UPS shutdown due to UPS FAILURE (fuse blown) or abnormal conditions for UPS (OVERTEMPERATURE or MAINS FAILURE).
3. Action needed following the alarm condition CALL SERVICE or output statement which can be APPLIC. ON UTILITY if the output is powered by mains or APPLIC. PROTECTED when the load is normally powered by the inverter.

### 6.3.1 User parameters screen

This screen allows the user to modify some parameters permitting to adapt some functions of the UPS to his/her needs, described as follows.

This screen can be accessed by entering *MENU/PARAMETER MENU/LEVEL 1: USER* and confirming with the key **Enter**.

```
PARAMETER MENU

LEVEL 1: USER
LEVEL 2: SERVICE
```

In **PARAMETER MENU** the buttons **+ / - / Enter** perform the following functions:

- +** This key allows to scroll forward to the next screen and, once the key **Enter** has been pressed, to move the horizontal selection to the next editable position.
- This key allows to move the selection to the next parameter and, once the key **Enter** has been pressed, to change the value of the selected character by the underscore cursor.
- Enter** Start the editing for the currently selected parameter.

#### 1. Date and time set-up

```
DATE AND TIME
      D M Y
Date: 01.01.2005
Hour: 12:15:45
```

1. Date and time setup.
2. **D** = Day      **M** = Month      **Y** = Year.
3. Date set-up: the set value is thoroughly checked to be a correct format "**dd.mm.yyyy**".
4. Time set-up: the set value is thoroughly checked to be a correct format "**hh.mm.ss**".  
The time is specified in 24 hour format.

#### 2. Modem protocol set-up

```
PROTOCOL SETUP
Modem enabled = N
Init=BEQV1X3&D0S0=2
Alarm=N      Delay=30s
```

1. Modem protocol set-up.
2. **Y**: enables or **N**: disables the modem call.
3. **Init**: this parameter presents the modem initialization string. It can be 39 characters long and considers that a blank character terminates the string. If no blank character is found then all 39 characters are used.
4. **Alarm**: **Y/N** controls the automatic events signaling through modem. If this parameter is set to **Y** (yes) the UPS itself will call the remote location when a new event occurs.  
**Delay**: This parameter controls the delay between the occurrence of a new event and the modem dialing. It is useful because since the events typically do not occur isolated but in certain sequences, you can eliminate the need for multiple dial-outs for such a sequence of events.

### 3. Telephone numbers set-up

Tel1:	
Tel1 enabled:	N
Tel2:	
Tel2 enabled:	N

**Tel1:** This parameter specifies a first tel. number to be used for modem dial-out.  
The telephone number has a maximum of 39 characters and cannot contain intermediate blank.  
If the desired number is shorter than 39 characters, finish the string with blanks.

**Tel1 enabled:** this parameter Y/N specifies if the **first telephone number** will be used for dial-out.

**Tel2:** it records the second dial-out number.

**Tel2 enabled:** this parameter Y/N specifies if the **second telephone number** will be used for dial-out.

**Tel3:** it records the third dial-out number.

**Tel3 enabled:** this parameter Y/N specifies if the **third telephone number** will be used for dial-out.

**Tel4:** it records the fourth dial-out number.

**Tel4 enabled:** this parameter Y/N specifies if the **fourth telephone number** will be used for dial-out.

### 4. LCD Display

LCD Display UPS NAME: LP 33  Language = ENGLISH
--

1. LCD display screen.
2. **UPS name:** the user can choice the name of the UPS model showed on the main page (11 digits).
4. **Language:** his parameter allows the choice of language used to display the information.  
Valid choices are *English, German, French, Spanish, Italian, Finnish and Polish.*

### 5. Operation mode selection (VFI Mode or ECO Mode)

ECO Mode <u>Y</u> d1 d2 d3 d4 d5 d6 d7 HOURS SELECTED 24 24 12 12 12 12 12
---



#### NOTE!

The ECO Mode can only be activated on single units.

1. **ECO Mode**  
This parameter (values **Y / N**) enables or disables the operation in **ECO Mode**.

If the value is **Y** and the current time is in the interval for the current day, the *ECO Mode* is active.

The activation / disactivation of *ECO Mode* is indicated each time in the event list.

In order to check the *inverter* function, at least **1 minute** of *VFI Mode* must be programmed during the week (the **Y / N** parameter is automatically disabled if this condition is not satisfied).

In case this minimum time in *VFI Mode* is not respected, the *ECO Mode* will be disabled.

If the value is **N**, the UPS is normally operating in **VFI / double conversion** mode at all times.



2. **d1 ÷ d7: Enabling time in function of weekdays.**

For the weekdays from **d1** to **d7** (*Saturday to Friday*) the edit mode (edit day) allows to define time intervals when the UPS is operating in *ECO Mode*.

The hour is given in 24-hour format.

These intervals are defined by:

**ECO Mode START:** the hour of the day after which the *ECO Mode* is enabled.  
The *ECO Mode* is enabled until the following *ECO STOP* time is reached (the *ECO STOP* time of the same day if this is later than the *ECO START* time, the *ECO STOP* time of the following day otherwise).

**ECO Mode STOP:** the hour of the day before which the *ECO Mode* is enabled.

The *ECO Mode* is enabled starting from the preceding *ECO START* time (the *ECO START* time of the same day if this is earlier than the *ECO STOP* time, the *ECO START* time of the previous day otherwise).

Identical times for *ECO START* and *ECO STOP* maintain the existing mode only in case the previous command was *ECO START* and the following command will be *ECO STOP*.

3. **HOURS SELECTED:** The number of *ECO Mode* hours per weekday (from **d1 - Saturday** to **d7 - Friday**) is displayed in the operation mode parameter window (ceiling value).

To better understand the *ECO Mode* programming, some typical examples are shown:

**Example 1:** For continuous *ECO Mode* set the *ECO START* times to **00:00** and the *ECO STOP* times to **23:59** for all weekdays, but almost **1 day must have 1 minute of VFI** programming: i.e **d2 - Sunday** 00:00 to 23:58).

Weekday	d1 - Saturday	d2 - Sunday	d3 - Monday	d4 - Tuesday	d5 - Wednesday	d6 - Thursday	d7 - Friday
<b>ECO START</b>	00:00	00:00	00:00	00:00	00:00	00:00	00:00
<b>ECO STOP</b>	23:59	23:58	23:59	23:59	23:59	23:59	23:59

**Example 2:** *ECO Mode STOP before ECO Mode START.*

*ECO START* 18:00, *ECO STOP* 06:00 for weekday **d4 - Tuesday**.

Means that on **d4 - Tuesday** the *ECO Mode* is active between 00:00 and 06:00 and between 18:00 and 23:59.

Weekday	d1 - Saturday	d2 - Sunday	d3 - Monday	d4 - Tuesday	d5 - Wednesday	d6 - Thursday	d7 - Friday
<b>ECO START</b>	00:00	00:00	00:00	18:00	00:00	00:00	00:00
<b>ECO STOP</b>	23:59	23:59	23:59	06:00	23:59	23:59	23:59

**Example 3:** *ECO Mode during the night and week-end.*

If the *ECO Mode* must be enabled all nights (**d3 - Monday ÷ d7 - Friday**) between 18:00 in the evening and 06:00 of the following morning and during all Saturday (**d1**) and Sunday (**d2**), the corresponding parameters are:

Weekday	d1 - Saturday	d2 - Sunday	d3 - Monday	d4 - Tuesday	d5 - Wednesday	d6 - Thursday	d7 - Friday
<b>ECO START</b>	00:00	00:00	18:00	18:00	18:00	18:00	18:00
<b>ECO STOP</b>	23:59	23:59	06:00	06:00	06:00	06:00	06:00

**Example 4:** If the *ECO Mode* must be enabled on *Monday (d3)* and *Tuesday (d4)* between 18:00 in the evening and 06:00 of the following morning, on *Friday (d7)* between 12:00 and 13:00, during all *Saturday (d1)* and on *Sunday (d2)* until 20:00, the corresponding parameters are.

Weekday	d1 - Saturday	d2 - Sunday	d3 - Monday	d4 - Tuesday	d5 - Wednesday	d6 - Thursday	d7 - Friday
<b>ECO START</b>	00:00	00:00	18:00	18:00	00:00	00:00	12:00
<b>ECO STOP</b>	23:59	20:00	23:59	06:00	06:00	00:00	13:00

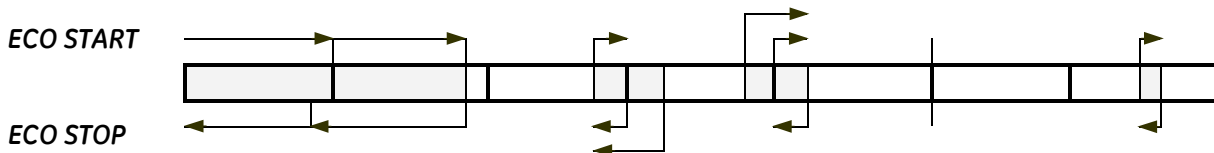

In dark colour are displayed the times with *ECO Mode* operation.

The arrows indicate the conditions given by the *ECO START* and *ECO STOP* times introduced with the parameters.

Note that on day **d6 - Tuesday** the interval has length 0 (zero), therefore the *ECO Mode* is not enabled on this day.

**Example 5:** An equivalent set of parameters for Example 4 is.

Weekday	d1 - Saturday	d2 - Sunday	d3 - Monday	d4 - Tuesday	d5 - Wednesday	d6 - Thursday	d7 - Friday
<b>ECO START</b>	00:00	00:00	18:00	18:00	06:00	09:00	12:00
<b>ECO STOP</b>	23:59	20:00	18:00	06:00	06:00	09:00	13:00

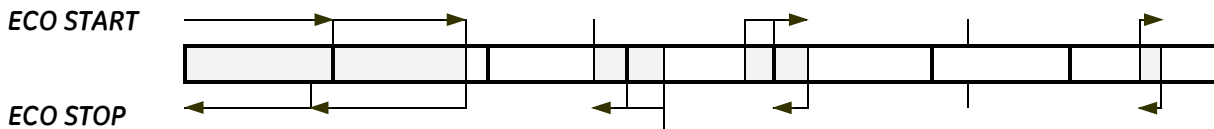

The *ECO Mode* is active from 18:00 of weekday **d3 - Monday** until 06:00 of weekday **d4 - Tuesday** (as indicated by the *ECO STOP* time of weekday **d4 - Tuesday**).

The *ECO STOP* time of weekday **d3 - Monday** has no effect as it is followed by the *ECO STOP* time of weekday **d4 - Tuesday**.

It can be, without change of meaning, any time between 18:00 and 23:59.

Similarly, the *ECO Mode* is active from 18:00 of weekday **d4 - Tuesday** until 06:00 of weekday **d5 - Wednesday**.

The *ECO START* time of weekday **d5 - Wednesday** has no effect as it is preceded by the *ECO START* time of weekday **d4 - Tuesday**.

It can be, without change of meaning, any time between 00:00 and 06:00.

	<p><b>To avoid undesired <i>ECO Mode</i> operation, verify:</b></p> <ul style="list-style-type: none"> <li>• <b>Date and Time (first page of parameter).</b></li> <li>• <b><i>ECO Mode</i> screen how many hours of <i>ECO Mode</i> operation have been selected for each day of the week.</b></li> </ul>
--	---

	<p><b>NOTE !</b></p> <p><b>The <i>ECO Mode</i> becomes active only if the load is supplied from inverter.</b></p>
--	---

# 7 OPERATION

## 7.1 PROCEDURES FOR SINGLE LP 33 Series

### 7.1.1 Start-up of the LP 33 Series

	<p>Before connecting hazardous voltages, make sure that:</p> <ul style="list-style-type: none"><li>• The connection to the electrical system has been performed by qualified personnel;</li><li>• The <i>equipment frame</i> has been correctly grounded to the <i>main earth</i>;</li><li>• Make sure that <i>mains input</i> protection is removed;</li><li>• All the <i>panels</i> removed to allow the UPS connection have been correctly reinstalled;</li><li>• The UPS switches <i>Q1</i> and <i>Q2</i> are OFF (Pos. 0);</li><li>• The <i>battery fuses F5, F6, F7</i> (and eventual external fuses in case of external battery) are removed.</li></ul>
---	--

This procedure must be performed for the first start-up following the installation, with the UPS completely switched Off and not powered.

This procedure presupposes that the *load* is not yet supplied by the UPS system.

	<p><b>NOTE !</b></p> <p>The UPS can be started-up using the <i>battery supply</i> in case the <i>input mains</i> should be unavailable.</p> <p>To avoid an incidental <i>battery</i> discharge, it is recommended to proceed to the UPS start-up having the <i>input mains</i> available.</p>
---	---

**1. Switch ON the mains power at the input distribution panel.**

As a result the UPS performs a self-test and the LCD will show the following screen:

```
EXECUTING MAINBOARD
SELF TEST
00000000000
SELF TEST OK!
```

	<p><b>NOTE !</b></p> <p>In case the alarm "<i>4410 - Mains bypass out of tolerance</i>" persists, please contact your <i>Service Center</i>.</p>
---	--

**2. Insert the battery fuses F5, F6, F7 and eventual external fuses in case of external battery.**

Continue ►

3. **Switch On the output switch Q1 (Pos. I).**

The output will be supplied by the *mains* through the *bypass*.

LP 33 40kVA  
**APPLICAT. ON UTILITY**  
= 70%

Verify, selecting the screen *METERING/Udcp* and *Udcn*, that the booster voltage has reached about **215 VDC**.

Udcp=**215V** Udcn=**215V**  
Ubp=164V Ubn=164V F  
Charge level = 100%  
Autonomy = 800min

4. **Switch On the inverter entering the screen:**

*MENU/COMMAND MENU/INVERTER ON*

COMMAND MENU  
**INVERTER ON** \*  
INVERTER OFF

Some seconds later the *load* will be transferred on *inverter* and the main screen will display: **APPLICATION ON UPS**

LP 33 40kVA  
**APPLICATION ON UPS**  
= 70%

5. **Operation mode selection.**

**LP 33 Series** is delivered normally selected for permanent *VFI* operation.

*ECO Mode* can be enabled and the *ECO START* time & *ECO STOP* time can be programmed for each day of the week (see Section 6.3.1-5).

**END OF PROCEDURE**



**NOTE !**

Even if the UPS is delivered with the *battery* fully charged, they could be partially discharged during transportation or storage.

It is recommended to recharge the battery during a few hours in order to provide the complete *battery* energy stored to the load in the event of *mains failure*.

## 7.1.2 UPS shutdown with load transfer on manual bypass (Q2)

The purpose of this procedure is to supply the *load* directly by *mains* through **manual bypass Q2**.

This procedure is normally performed when the UPS must be completely switched OFF for maintenance or service purpose, performed by an authorized *Service Center*.



### NOTE !

This procedure must not be performed if the UPS is used as *frequency converter*.

### 1. Switch OFF the inverter by entering the screen:

MENU/COMMAND MENU/**INVERTER OFF**

**Attention:** to switch OFF permanently the *inverter* the key **Enter** must be pressed **2 times**.

COMMAND MENU  
INVERTER ON  
**INVERTER OFF** \*

The output will be supplied by the mains through the *automatic bypass*.

LP 33 40kVA  
**APPLICAT. ON UTILITY**  
= 70%

### 2. Switch ON the maintenance bypass Q2 (Pos. I).

LP 33 40kVA  
**APPL. ON MANUAL DEV.**  
= 70%

### 3. Switch OFF the output switch Q1 (Pos. 0).

### 4. Perform the command total off.

### 5. Remove the battery fuses F5, F6, F7 and eventual external fuses in case of external battery.

Continue ►

6. **In order to discharge the DC link capacitors, start once more the inverter through the screen:**

MENU/COMMAND MENU/INVERTER ON

COMMAND MENU  
**INVERTER ON** \*  
 INVERTER OFF

**Remark:** command *INVERTER ON* will be enabled only when the inverter voltage of each phase decreases below **7 VAC** (about 30 seconds).

INVERTER: U1= **7V**  
 U2= **7V** U3= **7V**  
 Frequency = 60.0Hz  
 Synchronized

Before proceeding to step 7, check on the display panel that the *DC link voltage* (both polarities) *Udcp* and *Udcn* has reached the minimum voltage of **5 VDC** (about 30 seconds).

Udcp= **5V** Udcn= **5V**  
 Ubp=0V Ubn=0V 0  
 Charge level = 0%  
 Autonomy = 0min

7. **Switch OFF the inverter by entering the screen:**

MENU/COMMAND MENU/INVERTER OFF

COMMAND MENU  
 INVERTER ON  
**INVERTER OFF** \*

The *load* is now powered directly by *mains* through the *manual bypass Q2*.

END OF PROCEDURE



**WARNING !**

The UPS cabinet contains parts electrically live.  
 Apart from the front door, do not open any other part of the UPS.



**NOTE !**

With separate mains inputs, it's possible to disconnect mains rectifier.

### 7.1.3 Start-up following the operation on manual bypass (Q2)

This procedure presupposes that the *load* is powered by the *manual bypass* switch:

- The *inverter* is switched OFF;
- The *manual bypass* switch Q2 is switched ON (pos. I);
- The output switch Q1 is switched OFF (Pos. 0);
- The *battery fuses* F5, F6, F7 (and eventual external fuses in case of external battery) are removed.



#### NOTE !

This procedure must not be used if the UPS is used as *frequency converter*.

1. **Insert the battery fuses F5, F6, F7 and eventual external fuses in case of external battery.**
2. **Switch ON the output switch Q1 (Pos. I).**

3. Only in case it has been previously activated (\* present beside the text *RESET TOTAL OFF*), restore the command **total off** by entering the screen:  
*MENU/RESET TOTAL OFF*

LED TEST  
**RESET TOTAL OFF** \*

4. **Switch OFF the maintenance bypass Q2 (Pos. 0).**  
Verify, selecting the screen *METERING/Udcp* and *Udcn*, that the *booster* voltage has reached about **215 VDC**.

Udcp=215V Udcn=215V  
Ubp=164V Ubn=164V F  
Charge level = 100%  
Autonomy = 800min

5. **Switch ON the inverter by entering the screen:**  
*MENU/COMMAND MENU/INVERTER ON*

COMMAND MENU  
**INVERTER ON** \*  
INVERTER OFF

Some seconds later the *load* will be transferred on *inverter* and the main screen will display: **APPLICATION ON UPS**

LP 33 40kVA  
**APPLICATION ON UPS**  
= 70%

**END OF PROCEDURE**

### 7.1.4 Complete shutdown

As a result of this procedure the UPS is completely switched OFF and not powered.



#### NOTE !

This procedure involves all equipment powered by UPS, to be shut down.

1. Perform the command *total off*.
2. Switch OFF the output switch Q1 (Pos. 0).
3. Remove the battery fuses F5, F6, F7 and eventual external fuses in case of external battery.

4. In order to discharge the DC link capacitors, start once more the inverter through the screen:

MENU/COMMAND MENU/INVERTER ON

**Remark:** command *INVERTER ON* will be enabled only when the inverter voltage of each phase decreases below **7 VAC** (about 30 seconds).

Before proceeding to step 5, check on the display panel that the DC link voltage (both polarities) *Udcp* and *Udcn* has reached the minimum voltage of **5 VDC** (about 30 seconds).

COMMAND MENU  
INVERTER ON \*INVERTER OFF

INVERTER: U1= **7V**  
U2= **7V** U3= **7V**  
Frequency = 60.0Hz  
Synchronized

Udcp= **5V** Udcn= **5V**  
Ubp=0V Ubn=0V 0  
Charge level = 0%  
Autonomy = 0min

5. Switch OFF the inverter by entering the screen:

MENU/COMMAND MENU/INVERTER OFF

COMMAND MENU  
INVERTER ON  
INVERTER OFF \*

6. Switch OFF the mains power at the AC input distribution panel.

#### END OF PROCEDURE



#### CAUTION !

If the above procedure is not completely performed, it could cause serious damages to the UPS.



#### WARNING !

In case the procedure described on step "4 - discharge DC link capacitors" cannot be completely performed, the DC capacitors could be charged with dangerous voltage for about 15 minutes.

Wait until capacitors are completely discharged before starting the UPS again.

Apart from the front door, do not open any other part of the UPS.



### 7.1.5 Restore to normal operation after "total off"



**NOTE !**

Make sure the UPS to be status of the activation of "total off", i. e. Q1 closed, Q2 open and the *battery fuses F5, F6, F7* (and eventual external fuses in case of external battery) connected.

View of the panel after pressing the button "total off":

- All *Contactors* are open.
- *Booster, inverter and Static-Switch* shutdown.

LP 33 40kVA  
**APPLICAT. SUPPLY OFF**  
= 0%

**1. Reset "total off".**

Restore the command "total off" by entering the screen:  
*MENU/RESET TOTAL OFF*

The load is supplied by the *mains* through the *automatic bypass*.

The *booster* starts automatically.

The *LCD screen* must display the status:  
**APPLICATION ON BYPASS**

LED TEST  
**RESET TOTAL OFF** \*

LP 33 40kVA  
**APPLICATION ON BYPASS**  
= 70%

**2. Switch ON the inverter by entering the screen:**

*MENU/COMMAND MENU/INVERTER ON*

The *LCD screen* must display the status:  
**APPLICATION ON UPS**

COMMAND MENU  
**INVERTER ON** \*  
INVERTER OFF

LP 33 40kVA  
**APPLICATION ON UPS**  
= 70%

**END OF PROCEDURE**

## 7.1.6 Restore to normal operation after "EPO – Emergency Power Off"



### NOTE !

Make sure the UPS to be status of the activation of "EPO", i. e. Q1 closed, Q2 open and the *battery fuses F5, F6, F7* (and eventual external fuses in case of external battery) connected.

View of the panel after pressing the button "EPO":

- All *Contactors* are open.
- *Booster, inverter and Static-Switch* shutdown.

LP 33 40kVA  
**APPLICAT. SUPPLY OFF**  
= 0%

### 1. Reset the button "EPO".

Press *Alarm*, to reset *alarm and buzzer*.

01.01.2005 12:15:45  
NR=255 Status=A588  
4563: EMERGENCY OFF  
ACTIVATED

### 2. Reset the UPS by entering the screen: MENU/COMMAND MENU/INVERTER OFF

COMMAND MENU  
INVERTER ON \***INVERTER OFF**

The load is supplied by the *mains* through the *automatic bypass*.

The *booster* starts automatically.

The *LCD screen* must display the status:

**APPLICATION ON BYPASS**

LP 33 40kVA  
**APPLICATION ON BYPASS**  
= 70%

### 3. Switch ON the inverter by entering the screen: MENU/COMMAND MENU/INVERTER ON

The *load* will be automatically transferred from *mains* to the *inverter*.

The *LCD screen* must display the status:

**APPLICATION ON UPS**

COMMAND MENU  
**INVERTER ON** \*  
INVERTER OFF

LP 33 40kVA  
**APPLICATION ON UPS**  
= 70%

**END OF PROCEDURE**

## 7.2 PROCEDURES FOR PARALLEL SYSTEM LP 33 Series

### 7.2.1 Parallel System start-up of the LP 33 Series

	<p>Before connecting hazardous voltages, make sure that:</p> <ul style="list-style-type: none"> <li>• The connection to the electrical system has been performed by qualified personnel;</li> <li>• The <i>equipment frame</i> has been correctly grounded to the <i>main earth</i>;</li> <li>• Make sure that <i>mains input</i> protection is removed;</li> <li>• All the <i>panels</i> removed to allow the UPS connection have been correctly reinstalled;</li> <li>• The UPS switches Q1 and Q2 are OFF (Pos. 0);</li> <li>• The <i>battery fuses F5, F6, F7</i> (and eventual external fuses in case of external battery) are removed.</li> </ul>
---	---

This procedure must be performed for the first start-up following the installation, with all the units completely switched Off and not powered.

This procedure presupposes that the *load* is not yet supplied by the UPS system.

	<p><b>NOTE !</b></p> <p>The UPS can be started-up using the <i>battery supply</i> in case the <i>input mains</i> should be unavailable.</p> <p>To avoid an incidental <i>battery</i> discharge, it is recommended to proceed to the UPS start-up having the <i>input mains</i> available.</p>
---	---

1. **Switch ON the mains power for each unit at the input distribution panel.**

As a result each unit performs a self-test and the LCD will show the following screen:

<p>EXECUTING MAINBOARD SELF TEST 0000000000 SELF TEST OK!</p>
---

The LCD screen will display the number of the unit in the parallel system (*P1, P2, P3 or P4*).

	<p><b>NOTE !</b></p> <p>In case the alarm "4410 - Mains bypass out of tolerance" persists, please contact your <i>Service Center</i>.</p>
---	---

2. **Insert the battery fuses F5, F6, F7 (and eventual external fuses in case of external battery) on each unit.**

Continue ►

3. **Switch ON the output switch Q1 (Pos. I) on each unit.**

When the last Q1 will be closed, the output will be supplied by the mains through all *bypass*.

LP 33 40kVA P1  
**APPLICAT. ON UTILITY**  
= 70%

Verify, selecting the screen METERING/*Udcp* and *Udcn*, that the booster voltage has reached about **215 VDC**.

Udcp=**215V** Udcn=**215V**  
Ubp=164V Ubn=164V F  
Charge level = 100%  
Autonomy = 800min

4. **Switch ON the inverter on the first unit entering the screen:**  
*MENU/COMMAND MENU/INVERTER ON*

COMMAND MENU  
**INVERTER ON** \*  
INVERTER OFF

5. **Switch ON the inverter on the other units in the same manner.**  
(Do not start the next *inverter* until the sequence of the previous one ends – about 10 seconds).

COMMAND MENU  
**INVERTER ON** \*  
INVERTER OFF

Some seconds later the *load* will be transferred on inverter and the main screen of each unit will display:

**APPLICATION ON UPS**

LP 33 40kVA P1  
**APPLICATION ON UPS**  
= 70%

**END OF PROCEDURE**

	<p><b>NOTE !</b></p> <p>Even if the UPS is delivered with the <i>battery</i> fully charged, they could be partially discharged during transportation or storage.</p> <p>It is recommended to recharge the battery during a few hours in order to provide the complete <i>battery</i> energy stored to the load in the event of <i>mains failure</i>.</p>
---	--

## 7.2.2 Parallel UPS shutdown with load transfer on manual bypass (Q2)

The purpose of this procedure is to supply the *load* directly by *mains* through **manual bypass Q2**.

This procedure is normally performed when the UPS must be completely switched OFF for maintenance or service purpose, performed by an authorized *Service Center*.

1. **Switch OFF the inverter on each unit entering the screen:**  
MENU/COMMAND MENU/INVERTER OFF

**Attention:** to switch OFF permanently the *inverter* the key **Enter** must be pressed **2 times**.

```
COMMAND MENU
INVERTER ON
INVERTER OFF *
```

The output will be supplied by the mains through all *automatic bypass*.

```
LP 33 40kVA P1
APPLICAT. ON UTILITY
= 70%
```

2. **Switch ON the maintenance bypass Q2 (I) on each unit.**

```
LP 33 40kVA P1
APPL. ON MANUAL DEV.
= 70%
```

3. **Switch OFF the output switch Q1 (O) on each unit.**

4. **Perform the command total off on each unit.**

5. **Remove the battery fuses F5, F6, F7 (and eventual external fuses in case of external battery) on each unit.**

Continue ►

6. **In order to discharge the DC link capacitors, start once more the inverter on each unit through the screen:**  
 MENU/COMMAND MENU/INVERTER ON

COMMAND MENU  
**INVERTER ON** \*  
 INVERTER OFF

**Remark:** command *INVERTER ON* will be enabled only when the inverter voltage of each phase decreases below **7 VAC** (about 30 seconds).

INVERTER: U1= **7V**  
 U2= **7V** U3= **7V**  
 Frequency = 60.0Hz  
 Synchronized

Before proceeding to step 7, check on the display panel that the *DC link voltage* (both polarities) *Udcp* and *Udcn* has reached the minimum voltage of **5 VDC** (about 30 seconds).

Udcp= **5V** Udcn= **5V**  
 Ubp=0V Ubn=0V 0  
 Charge level = 0%  
 Autonomy = 0min

7. **Switch OFF the inverter on each unit entering the screen:**  
 MENU/COMMAND MENU/INVERTER OFF

COMMAND MENU  
 INVERTER ON  
**INVERTER OFF** \*

The *load* is now supplied directly from the mains through the manual switches Q2.

**END OF PROCEDURE**

	<p><b>WARNING !</b></p> <p>The UPS cabinet contains parts electrically live.          Apart from the front door, do not open any other part of the UPS.</p>
---	---

	<p><b>NOTE !</b></p> <p>With separate mains inputs, it's possible to disconnect mains rectifier.</p>
---	--

### 7.2.3 Start-up following the operation on maintenance bypass (Q2)

This procedure presupposes that the *load* is powered by the *manual bypass* switch:

- The *inverter* is switched OFF;
- The *manual bypass* switch Q2 is switched ON (Pos. I);
- The output switch Q1 is switched OFF (Pos. 0);
- The *battery fuses* F5, F6, F7 (and eventual external fuses in case of external battery) are removed.

1. **Insert the rectifier input fuses F1, F2, F3 and the battery fuses F9, F10, F11 / F13, F14, F15 (and eventual external battery fuses) on each unit.**

2. **Switch ON the output switch Q1 (Pos. I) on each unit.**

3. Only in case it has been previously activated (\* present beside the text *RESET TOTAL OFF*), restore the command *total off* on **any one of the units** by entering the screen:

*MENU/RESET TOTAL OFF*

```
LED TEST
RESET TOTAL OFF *
```

4. **Open the maintenance bypass switch Q2 (Pos. 0) on each unit.**

Verify, selecting the screen *METERING/Udcp* and *Udcn*, that the booster voltage has reached about **215 VDC** on each unit.

```
Udcp=215V   Udcn=215V
Ubp=164V    Ubn=164V F
Charge level = 100%
Autonomy    = 800min
```

5. **Switch ON the inverter on each unit entering the screen:**

*MENU/ COMMAND MENU /INVERTER ON*

(Do not start the next *inverter* until the sequence of the previous one ends – about 10 seconds).

The *load* will be automatically transferred from *mains* to the *inverters* as the needed power requested from the applied load is achieved on *inverter* side.

The main screen of each unit will display:

**APPLICATION ON UPS**

```
COMMAND MENU
INVERTER ON *
INVERTER OFF
```

```
LP 33   40kVA P1
APPLICATION ON UPS
= 70%
```

**END OF PROCEDURE**

## 7.2.4 Shutdown of a single unit in a parallel system

With purpose to separate one unit from the parallel system.

1. **Switch OFF the inverter only on this unit entering the screen:**  
MENU/COMMAND MENU/INVERTER OFF

**Attention:** to switch OFF permanently the *inverter* the key **Enter** must be pressed **2 times**.

```
COMMAND MENU
INVERTER ON
INVERTER OFF *
```

2. **Switch OFF the output switch Q1 (0) only on this unit.**
3. **Perform the command total off only on this unit.**
4. **Remove the battery fuses F5, F6, F7 (and eventual external fuses in case of external battery) only on this unit.**

5. **In order to discharge the DC link capacitors, start once more the inverter only on this unit through the screen:**  
MENU/COMMAND MENU/INVERTER ON

**Remark:** command *INVERTER ON* will be enabled only when the inverter voltage of each phase decreases below **7 VAC** (about 30 seconds).

```
COMMAND MENU
INVERTER ON *
INVERTER OFF
```

```
INVERTER:      U1= 7V
U2= 7V         U3= 7V
Frequency = 60.0Hz
Synchronized
```

Before proceeding to step **6**, check on the display panel that the *DC link voltage* (both polarities) *Udcp* and *Udcn* has reached the minimum voltage of **5 VDC** (about 30 seconds).

```
Udcp= 5V      Udcn= 5V
Ubp=0V        Ubn=0V 0
Charge level  = 0%
Autonomy     = 0min
```

6. **Switch OFF the inverter only on this unit entering the screen:**  
MENU/COMMAND MENU/INVERTER OFF

```
COMMAND MENU
INVERTER ON
INVERTER OFF *
```

7. **Switch OFF the mains power only on this unit at the AC input distribution panel.**

**END OF PROCEDURE**



### **WARNING !**

In case the unit should be disconnected and removed from the operating system, the operation must be performed by qualified persons.

If an intermediate unit must be disconnected from a parallel system pay attention do not open the control bus: keep the plugs J3 and J4 connected to the board "P16 - Connector adapter RPA" (see Section 4.8.4).



## 7.2.5 Start-up an additional unit in a parallel system

	<p>Before connecting hazardous voltages, make sure that:</p> <ul style="list-style-type: none"> <li>• The connection to the electrical system has been performed by qualified personnel;</li> <li>• The <i>equipment frame</i> has been correctly grounded to the <i>main earth</i>;</li> <li>• Make sure that <i>mains input</i> protection is removed;</li> <li>• All the <i>panels</i> removed to allow the UPS connection have been correctly reinstalled;</li> <li>• The UPS switches <i>Q1</i> and <i>Q2</i> are OFF (Pos. 0);</li> <li>• The <i>battery fuses F5, F6, F7</i> (and eventual external fuses in case of external battery) are removed.</li> </ul>
---	---

This procedure must be performed when the *load* is supplied by the other units of the UPS system and an additional unit must be switched ON and connected to the parallel bus in order to share the load with each other.

This unit must be completely switched OFF and not powered.

1. **Switch ON the mains power at the input distribution pane on this unit.**

As a result the UPS performs a self-test and the *LCD* will show the following screen:

```
EXECUTING MAINBOARD
SELF TEST
00000000000
SELF TEST OK!
```



### NOTE!

In case the alarm "4410 - Mains bypass out of tolerance" persists, please contact your *Service Center*.

2. **Insert the battery fuses F5, F6, F7 (and eventual external fuses in case of external battery) on this unit.**
3. **Switch ON the output switch Q1 (Pos. I) on this unit.**

```
LP 33    40kVA P2
APPLICAT. ON UTILITY
= 70%
```

Verify, selecting the screen *METERING/Udcp* and *Udcn*, that the *booster* voltage has reached about **215 VDC** of this unit.

```
Udcp=215V   Udcn=215V
Ubp=164V    Ubn=164V F
Charge level = 100%
Autonomy    = 800min
```

4. **Switch ON the inverter of this unit entering the screen:**  
*MENU/COMMAND MENU/INVERTER ON*

```
COMMAND MENU
INVERTER ON      *
INVERTER OFF
```

When the inverter will be synchronized, the unit will be automatically connected with the parallel bus-bar and the load will be shared with the other units.

The main screen of each unit will display: **APPLICATION ON UPS**

```
LP 33    40kVA P2
APPLICATION ON UPS
= 70%
```

**END OF PROCEDURE**

## 7.2.6 Complete shutdown of a parallel system

As a result of this procedure the parallel system is completely switched OFF and not powered.

	<b>NOTE !</b> This procedure involves all equipment powered by parallel system, to be shut down.
---	---

1. Perform the command total off on any one of the units.
2. Switch OFF the output switch Q1 (Pos. 0) on each unit.
3. Remove the battery fuses F5, F6, F7 (and eventual external fuses in case of external battery) on each unit.

4. In order to discharge the DC link capacitors, start once more the inverter on each unit through the screen:

MENU/COMMAND MENU/INVERTER ON

**Remark:** command *INVERTER ON* will be enabled only when the inverter voltage of each phase decreases below **7 VAC** (about 30 seconds).

Before proceeding to step 5, check on the display panel that the DC link voltage (both polarities) *Udcp* and *Udcn* has reached the minimum voltage of **5 VDC** (about 30 seconds).

COMMAND MENU	
INVERTER <u>ON</u>	*
INVERTER OFF	

INVERTER:	U1= 7V
	U2= 7V      U3= 7V
Frequency =	60.0Hz
	Synchronized

Udcp= 5V	Udcn= 5V
Ubp=0V	Ubn=0V 0
Charge level =	0%
Autonomy =	0min

5. Switch OFF the inverter on each unit entering the screen:  
MENU/COMMAND MENU/INVERTER OFF

MENU COMANDI	
INVERTER ON	
INVERTER <u>OFF</u>	*

6. Switch OFF the mains power of each unit at the AC input distribution panel.

END OF PROCEDURE

	<b>CAUTION !</b> If the above procedure is not completely performed, it could cause serious damages to the UPS.
---	--

	<b>WARNING !</b> In case the procedure described on step "4 - discharge DC link capacitors" cannot be completely performed, the DC capacitors could be charged with dangerous voltage for about 15 minutes. Wait until capacitors are completely discharged before starting the UPS again. Apart from the front door, do not open any other part of the UPS.
---	---

## 7.2.7 Restore to normal operation after "total off"



### NOTE !

Make sure the all units of the parallel system to be status of the activation of "total off", i. e. Q1 closed, Q2 open the *battery fuses F5, F6, F7* (and eventual external fuses in case of external battery) connected.

View of the panel after pressing the button "total off":

- All *Contactors* are open.
- *Booster, inverter eand Static-Switch* shutdown.

LP 33 40kVA P1  
**APPLICAT. SUPPLY OFF**  
= 0%

### 1. Reset "total off" of the parallel system.

Restore the command "total off", on any one of the units, by entering the screen: **MENU/RESET TOTAL OFF**

The load is supplied by the *mains* through the *automatic bypass*.

The *booster* starts automatically.

The *LCD screen* must display on all *Units* the status:

**APPLICATION ON BYPASS**

LED TEST  
**RESET TOTAL OFF** \*

LP 33 40kVA P1  
**APPLICATION ON BYPASS**  
= 70%

### 2. Switch ON the inverter on first unit by entering the screen:

**MENU/COMMAND MENU/INVERTER ON**

In case of sufficient output power, the output will transfer to *Inverter*.

COMMAND MENU  
**INVERTER ON** \*  
INVERTER OFF

### 3. Switch ON the inverter on the other units by entering the screen: **MENU/COMMAND MENU/INVERTER ON**

(Do not start the next *inverter* until the sequence of the previous one ends – about 10 seconds).

As soon as the output power of the *inverters* is sufficient to supply the *load*, the output of the units with running *inverter* will transfer to *inverter*.

The *LCD screen* must display on all *Units* the status:

**APPLICATION ON UPS**

COMMAND MENU  
**INVERTER ON** \*  
INVERTER OFF

LP 33 40kVA P1  
**APPLICATION ON UPS**  
= 70%

**END OF PROCEDURE**

## 7.2.8 Restore to normal operation after “EPO – Emergency Power Off”

	<p><b>NOTE !</b></p> <p>Make sure the all units of the parallel system to be status of the activation of <i>EPO</i>, i. e. <i>Q1</i> closed, <i>Q2</i> open and the <i>battery fuses F5, F6, F7</i> (and eventual external fuses in case of external battery) connected.</p>
---	--

View of the panel after pressing the button “EPO”:

- All *Contactors* are open.
- *Booster, inverter* and *Static-Switch* shutdown.

LP 33 40kVA P1  
**APPLICAT. SUPPLY OFF**  
 = 0%

1. **Reset the button “EPO”.**

Press *Alarm*, to reset *alarm* and *buzzer*.

01.01.2005 12:15:45  
 NR=255 Status=A588  
 4563: EMERGENCY OFF  
 ACTIVATED

2. **Reset all UPS by entering the screen:**

MENU/COMMAND MENU/**INVERTER OFF**

The load is supplied by the *mains* through the *automatic bypass*.

The *booster* starts automatically.

The *LCD screen* must display on all *Units* the status:

**APPLICATION ON BYPASS**

COMMAND MENU  
 INVERTER ON \*

**INVERTER OFF**

LP 33 40kVA P1  
**APPLICATION ON BYPASS**  
 = 70%

3. **Switch ON the inverter on first unit by entering the screen:**

MENU/COMMAND MENU/**INVERTER ON**

In case of sufficient output power, the output will transfer to *Inverter*

COMMAND MENU  
**INVERTER ON** \*

INVERTER OFF

4. **Switch ON the inverter on the other units by entering the screen:** MENU/COMMAND MENU/**INVERTER ON**

(Do not start the next *inverter* until the sequence of the previous one ends – about 10 seconds).

As soon as the output power of the *inverters* is sufficient to supply the *load*, the output of the units with running *inverter* will transfer to *inverter*.

The *LCD screen* must display on all *Units* the status:

**APPLICATION ON UPS**

MENU COMANDI  
**INVERTER ON** \*

INVERTER OFF

LP 33 40kVA P1  
**APPLICATION ON UPS**  
 = 70%

**END OF PROCEDURE**

# 8 OPTIONS

## 8.1 OPTIONS GENERAL VIEW

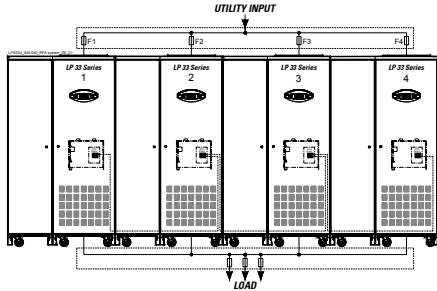

### **RPA kit** *Redundant Parallel Architecture*

Allows to extend the unit to a parallel system with 2, 3, or 4 units connected on the same bus, which ensure the highest reliability rate and increase the power availability without prior investments.

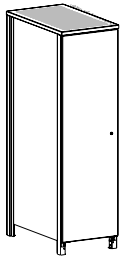

### **Additional battery charge**

For battery with extended backup time (max. 15A).

Dimensions (WxDxH): 16.93" x 28.55" x 70.95" / 430 x 725 x 1802 mm

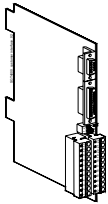

### **Customer Interface**

The *Customer Interface* allows the client the exchange of information (monitoring and control) with the following interfaces:

- Serial port *RS232*.
- 6 programmable output channels.
- 2 programmable input channels, of witch one for *GEN-ON*.
- *EPO* (Emergency Power Off).

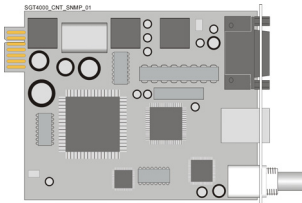

### **Advanced SNMP Card** *Simple Network Management Protocol*

The *Advanced SNMP Card* is an interface to the *Ethernet Network*, and provides UPS information via the standard *SNMP Protocol* (UPS-MIB (RFC-1628); GE Single MIB; GE Parallel MIB).

The UPS can therefore be managed by a *Network Management System (NMS)* or by our applications (for instance *JUMP*), which uses this information to determine the state of the UPS in order to guarantee safe and orderly shutdown of the server, when needed.

# JUMP

Java®  
Universal Management Platform

### **Connectivity Software**

*JUMP Software Suite / IRIS Service, etc.*

Software application for the control and monitoring of the UPS.

# 9 MAINTENANCE



## WARNING !

All maintenance and service works must be performed by **QUALIFIED SERVICE PERSON**.

## 9.1 GENERAL MAINTENANCE

When used properly, the **LP 33 Series** UPS is virtually maintenance free.

Take care of proper environmental conditions (see Installation Guide - *Section 3.5 – Ventilation & Cooling*) and keep air inlets/outlets free from dust and any other obstacle.

## 9.2 COOLING FAN MAINTENANCE

The expected operational life of the cooling fans is approximately **40.000 hours** of continuous operation.

A high ambient temperature will shorten this operational life.

## 9.3 BATTERY MAINTENANCE

The service life of the battery is from **3 to 6 years**, depending on the operating temperature and on the number of discharge cycles.

The UPS **LP 33 Series** offers the possibility of *SBM (Superior Battery Management)*.

The function *SBM* can be activated through a service Parameter.

The functionality of *SBM* reduces the Battery recharging time together with improved lifetime of the Battery.

As a healthy battery is essential to the performance of the UPS, an automatic or manual battery test can be performed regularly to ensure failsafe operation, in order to check if the battery can provide the expected backup time in case of mains failure.

We recommend the battery test be performed at least every **1 month**, especially if the battery is not sufficiently discharged during normal operation.

Since the parameter enabling the *battery test* protected by *user password*, please contact your **Service Center** for more information.

Please consider that, if you did a full battery test to verify the full runtime of the battery, the charger needs at least **8 hours** to recharge the battery up to **90%** of its capacity.

To guarantee that the battery is fully charged, the UPS system should be in operation for at least **12 hours every 3 months**.

When the condition of the battery is critical, the warning signal will be activated (general alarm, buzzer and alarm message "4118 - Battery fault").

In this case the battery must be replaced as soon as possible.

Please contact your **Service Center**.

## 9.4 SERVICE REQUIRED

LP 33 40 kVA  
APPLICATION ON UPS  
= 70%  
**SERVICE REQUIRED**

If this lamp lights up during the normal operation (service parameter with password), the performances of the UPS remain the same, but that means the unit has not been serviced for the last **20.000 hours** by a qualified *GE Service Engineer*.

Some components of the UPS which need periodic maintenance, if not replaced, could cause a reliability reduction of the supply system.

We highly recommend that you contact your **Service Center** for preventive maintenance work.

### **NOTE !**

Ask to your local *Service Center* to submit the form of *Preventive Maintenance Contract* suitable for your specific needs.

# 10 NOTES

## 10.1 NOTES FORM

It is recommended to note in this section **Notes**, with date and short description all the operations performed on the UPS, as: maintenance, components replacement, abnormal situations, etc. .

<i>Date</i>	<i>Description</i>	<i>Done by</i>



## RIDER FOR WARRANTY FOR SALE OF *SitePro*<sup>™</sup>, DIGITAL ENERGY<sup>™</sup> *SG Series* and *LP Series* UPS.

This Rider incorporates by reference the Terms and Conditions in GE Industrial Systems (herein called GE) GETC2003, and includes the following additional provisions contained herein.

In the event of conflict between this Rider and GETC2003, the Rider shall take precedence.

### Limitation on use with life support equipment:

Customer understands and agrees that the products sold hereunder are not intended for application or use, and shall not be used: (i) in conjunction with or for life support equipment when failure of any product can be reasonably be expected to cause failure of or diminish the effectiveness of such life support Customer represents and warrants that it shall NOT USE THE PRODUCTS FOR ANY SUCH PURPOSES, OR PERMIT OTHERS TO USE THE PRODUCTS FOR ANY SUCH PURPOSES.

If, in breach of the foregoing, any such use occurs, Seller shall have no liability for any resulting damage or injury, in addition to any other legal or equitable rights of Seller, Customer shall indemnify Seller against any such liability, whether arising as a result of breach of contract, warranty, indemnity, tort (including negligence), strict liability or otherwise.

**WARRANTY:** Seller warrants to Customer that during the "Warranty Period" applicable for its *SitePro*, Digital Energy<sup>™</sup> *SG Series* and *LP Series* UPS Product furnished hereunder (the "Product") will be free from defects in material, workmanship and title.

The warranty period ("Warranty Period") for the specified Product begins on the earlier of three (3) months after the delivery date or upon commissioning of the Product (if applicable) and ends at the end of the period as set forth below:

The Warranty Period for the specified Product is as follows:

<b><i>SitePro / Digital Energy<sup>™</sup> SG Series UPS</i></b>	<b>12 Months</b>
<b><i>LP Series UPS</i></b>	<b>24 Months</b>

In no case does this warranty apply to any failure or nonconformance with specifications caused by or attributable to any associated or complementary products not supplied under these Terms and Conditions, nor shall it in any case apply to the quantity or quality of the product of Customer or the process of manufacture on which any products are used.

The warranties and remedies set forth herein are conditioned upon (a) proper transportation, handling, storage, installation, commissioning, operation, use and maintenance in conformance with the operation instruction manuals (including revisions thereto) provided by Seller, any applicable recommendations of Seller and any applicable laws, regulations or codes (b) repair or modification pursuant to Seller's instructions or approval and (c) Customer promptly notifying Seller of any defects and, if required, promptly making the Product available for correction at Customer's expense. This warranty shall not apply (a) if Customer or any other unauthorized person has made any modifications, alterations or repairs to the Product not authorized by Seller, including Customer's use of parts in conjunction with the Product (excluding batteries) not admitted or delivered by Seller, (b) to a Product with removed or altered serial numbers, (c) to a Product damaged by acts of God, sources external to the Product, misuse, accident, abuse, neglect, negligence, or use beyond rated capacity, and (d) if GE authorized field service technician does not commission Digital Energy<sup>™</sup> *SG Series* UPS and *SitePro* UPS.

If any Product or service fails to meet the foregoing warranties (except title), Seller shall thereupon correct any such failure either, at its option, by (i) repairing any defective or damaged part or Product and/or reperforming any defective service or (ii) making available, F.O.B. at Seller's facility, place of manufacture or other mutually agreed upon point of shipment, any necessary repaired or replacement parts; provided, however, that prior to repairing any defective or damaged part or Product, Seller shall have received, at Customer's cost, such part or Product in need of repair or replacement.

If reperformance is not practicable, Seller will furnish without charge services in an amount essentially equal to those that, in the sole judgment of Seller, would have been required for reperformance.

Where a failure cannot be corrected by Seller's reasonable efforts, the parties will negotiate an equitable adjustment in price.

In providing a replacement Product or parts, Seller reserves the right to use refurbished circuit boards, which shall be warranted in accordance with this Warranty Provision.

The correction of any failure or the supply of repaired or replacement parts or Products pursuant to this Warranty Provision shall not extend the duration of the applicable Warranty Period.

Seller does not warrant the following items: (i) computer hardware, (ii) any computer software, including software provided by Seller with any Product, (iii) products or services obtained from others or (iv) any batteries used in conjunction with the products, including those provided by Seller, and in regard to these items, only the warranty of the manufacturer, if any, shall apply.

Seller's obligation under this Provision entitled "Warranty" shall terminate immediately upon any modification of the Product by Customer unless made with the approval of Seller.

The Warranty Period applicable to each Product can be extended, if Customer purchases an extended warranty from Seller.

If Customer purchases an extended warranty from Seller, the terms of such extended warranty shall supersede these warranty provisions.

THE PRECEDING PARAGRAPHS OF THIS WARRANTY PROVISION SET FORTH THE EXCLUSIVE CLAIMS (EXCEPT AS TO TITLE) BASED ON DEFECT IN OR FAILURE OF A PRODUCT, WHETHER THE CLAIM IS IN CONTRACT, INDEMNITY, WARRANTY, TORT (INCLUDING NEGLIGENCE), STRICT LIABILITY OR OTHERWISE.

Upon the expiration of the applicable Warranty Period, all such liability shall terminate and Customer shall have a reasonable time, not to exceed thirty (30) days after the applicable Warranty Period, to give written notice of any defects that appeared during the Warranty Period.

THE FOREGOING WARRANTIES ARE EXCLUSIVE AND IN AND IN LIEU OF ALL OTHER WARRANTIES, WHETHER WRITTEN, ORAL, IMPLIED OR STATUTORY.

NO IMPLIED STATUTORY WARRANTY OF MERCHANTABILITY OR FITNESS FOR A PARTICULAR PURPOSE SHALL APPLY.

**INSTALLATION AND COMMISSIONING OF INSTALLABLE SYSTEMS:** If the Products cannot be installed immediately after delivery, Customer is responsible for maintaining proper storage conditions according to operating manuals and any other instructions provided by Seller.

Installable Products may only be installed by certified electrical installers and must be installed according to Seller's specifications, appropriate national electrical codes and accepted standards of workmanship.

For purposes of these GE Terms and Conditions, "Installable Products" shall mean Products that require the services of a certified electrical installer to be connected to the power grid.

The commissioning of installable Products may only be done by a technician authorized by Seller and must be done according to Seller's specifications.

For purposes of these GE Terms and Conditions, "commissioning" shall mean the start-up of the installable Products and the testing of the installable Products in connection with the load.

If commissioning is to be performed by Seller, Seller may refuse to commission the installable Products, if the operating conditions at Customer's site do not allow safe commissioning and operation of the installable Products.

Any costs resulting from a delay in commissioning will be charged to Customer.

## Free Manuals Download Website

<http://myh66.com>

<http://usermanuals.us>

<http://www.somanuals.com>

<http://www.4manuals.cc>

<http://www.manual-lib.com>

<http://www.404manual.com>

<http://www.luxmanual.com>

<http://aubethermostatmanual.com>

Golf course search by state

<http://golfingnear.com>

Email search by domain

<http://emailbydomain.com>

Auto manuals search

<http://auto.somanuals.com>

TV manuals search

<http://tv.somanuals.com>