



Use and Care Guide

Gas Slide-in Range



Safety [instructions.....	2-6
Anti-Tip Device	2,4, 25



Operating Instructions, Tips	
Aluminum Foil	5, 14-17,23
Clock and Timer	10
Features	7
Oven	10-18
Baking	12-14
Broiling, Broiling Guide	17, 18
Control Settings	12, 16, 18
Light; Bulb Replacement	11, 21
Preheating	12
Roasting, Roasting Guide	15, 16
Surface Cooking	8,9
Control Settings	8, 9
Cooktop Comparison	8
Cookware Tips	9



Care and Cleaning	19-24
Broiler Pan and Rack	22
Continuous-Clean Oven	24
Cooktop	19
Oven Bottom	23
Oven Door	21



Problem solver	26
Thermostat Adjustment-	
<i>Do It Yourself</i>	14
More questions ?...call	
GE Answer Center® 800.626.2000	



Flooring and Leveling	6
Flooring Under the Range	6
Leveling the Range	6
Removal of Packaging Tape	6
Removing Packaging Materials	6



Consumer Services	27
Appliance Registration	2
Important Phone Numbers	27
Model and Serial Number Location	2
Warranty	Back Cover



HELP US HELP YOU...

Read this guide carefully.

It is intended to help you operate and maintain your new range properly.

Keep it handy for answers to your questions.

If you don't understand something or need more help, call:

GE Answer Center®

800.626.2000

24 hours a day, 7 days a week

Write down the model and serial numbers.

You'll find the model and serial numbers on two labels on the range front frame near the broiler drawer.

These numbers are also on the Consumer Product Ownership Registration Card that came with your range. Before sending in this card, please write these numbers here:

Model Number

Serial Number

Use these numbers in any correspondence or service calls concerning your range.

If you received a damaged range...

Immediately contact the dealer (or builder) that sold you the range.

Save time and money. Before you request service . . .

Check the Problem Solver in the back of this guide. It lists causes of minor operating problems that you can correct yourself.



A WARNING

- ALL RANGES CAN TIP
- INJURY TO PERSONS COULD RESULT
- INSTALL ANTI-TIP DEVICES PACKED WITH RANGE
- SEE INSTALLATION INSTRUCTIONS

WARNING: If the information in this guide is not followed exactly, a fire or explosion may result causing property damage, personal injury or death.

- Do not store or use gasoline or other flammable vapors and liquids in the vicinity of this or any other appliance.
- WHAT TO DO IF YOU SMELL GAS
 - Do not try to light any appliance.
 - Do not touch any electrical switch; do not use any phone in your building.
 - Immediately call your gas supplier from a neighbor's phone. Follow the gas supplier's instructions.
 - If you cannot reach your gas supplier, call the fire department.
- Installation and service must be performed by a qualified installer, service agency or the gas supplier.

IF YOU NEED SERVICE

To obtain service, see the Consumer Services page in the back of this guide.

To obtain replacement parts, contact GE/Hotpoint Service Centers.

We're proud of our service and want you to be pleased. If for some reason you are not happy with the service you receive, here are three steps to follow for further help.

FIRST, contact the people who serviced your appliance. Explain why you are not pleased. In most cases, this will solve the problem.

NEXT, if you are still not pleased, write all the details—including your phone number—to:

Manager, Consumer Relations
 GE Appliances
 Appliance Park
 Louisville, KY 40225

FINALLY, if your problem is still not resolved, write:

Major Appliance Consumer Action Panel
 20 North Wacker Drive
 Chicago, IL 60606

IMPORTANT SAFETY INSTRUCTIONS

Read all instructions before using this appliance.



IMPORTANT SAFETY NOTICE

- The California Safe Drinking Water and Toxic Enforcement Act requires the Governor of California to publish a list of substances known to the state to cause cancer, birth defects or other reproductive harm, and requires businesses to warn customers of potential exposure to such substances.
- Gas appliances can cause minor exposure to four of these substances, namely benzene, carbon monoxide, formaldehyde and soot, caused primarily by the incomplete combustion of natural gas or LP fuels. Properly adjusted burners, indicated by a bluish rather than a yellow flame, will minimize incomplete combustion. Exposure to these substances can be minimized by venting with an open window or using a ventilation fan or hood.

When You Get Your Range

- **Have the installer show you the location of the range gas cut-off valve and how to shut off if necessary.**
- **Have** your range installed and properly grounded by a qualified installer, in accordance with the Installation Instructions. Any adjustment and service should be performed only by qualified gas range installers or service technicians.
- Do not attempt to repair or replace any part of your range unless it is specifically recommended in this guide. All other servicing should be referred to a qualified technician.
- Plug your range into a 120-volt grounded outlet only. Do not remove the round grounding prong from the plug. If in doubt about the grounding of the home electrical system, it is your personal responsibility and obligation to have an ungrounded outlet replaced with a properly grounded, three-prong outlet in accordance with the National Electrical Code. Do not use an extension cord with this appliance.
- Be sure **all** packaging materials are removed from the **range** before operating it to prevent fire or smoke damage should the packaging material ignite.
Locate the range out of kitchen traffic path and out of drafty locations to prevent pilot outage and poor air circulation.

- Be sure your range is correctly adjusted by a qualified service technician **or installer for the type of gas (natural or LP) that is to be used.** Your range can be converted for use with either type of gas. See the Installation Instructions.

WARNING: These adjustments must be made by a qualified service technician in accordance with the manufacturer's instructions and all codes and requirements of the authority having jurisdiction. Failure to follow these instructions could result in serious injury or property damage. The qualified agency performing this work assumes responsibility for the conversion.

- After prolonged use of a range, high floor temperatures may result and many **floor** coverings will not withstand this kind of use. Never install the range over vinyl tile or linoleum that cannot withstand such type of use. Never install it directly over interior kitchen carpeting.

Using Your Range

- Do not leave children alone or unattended where a range is hot or in operation. They could be seriously burned.
- Do not allow anyone to **climb**, stand or hang on the oven door, broiler drawer or **cooktop**. They could damage the range and even tip it over, causing severe personal injury.
- **CAUTION: ITEMS OF INTEREST TO CHILDREN SHOULD NOT BE STORED IN CABINETS ABOVE A RANGE OR ON THE BACKSPASH OF A RANGE—CHILDREN CLIMBING ON THE RANGE TO REACH ITEMS COULD BE SERIOUSLY INJURED.**
- For continuous clean models, do not use oven cleaners on any of the continuous cleaning surfaces. Continuous cleaning surfaces can be identified by their rough surface finish.
- Teach children not to play with the controls or any other part of the range.
- Never leave the oven door open when you are not watching the range.
- Always keep combustible wall coverings, curtains or drapes a safe distance from your range.

(continued next page)



IMPORTANT SAFETY INSTRUCTIONS

(continued)

A WARNING—

All ranges can tip and injury could result. To prevent accidental tipping of the range, attach it to the wall or floor by installing the Anti-Tip device supplied. Make sure the chain fits securely into the slot in the bracket.

If you pull the range out from the wall for any reason, make sure the device is properly engaged when you push the range back against the wall. If it is not, there is a possible risk of the range tipping over and causing injury if you or a child stand, sit or lean on an open door.

Please refer to the Anti-Tip device information in “this guide. Failure to take this precaution could result in tipping of the range and injury.

Do not allow the chain or bracket to damage the gas plumbing in any way.

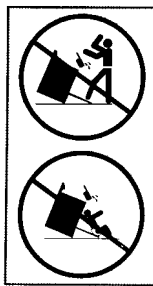

- Let the burner grates and other surfaces cool before touching them or leaving them where children can reach them.
- Never wear loose fitting or hanging garments while using the appliance. Be careful when reaching for items stored in cabinets over the cooktop. Flammable material could be ignited if brought in contact with flame or hot oven surfaces and may cause severe burns.
- For your safety, never use your appliance for warming or heating the room.
- **Always** keep dish towels, dish cloths, pot holders and other linens a safe distance from your range.
- Always keep wooden and plastic utensils and canned food a safe distance away from your range.
- Do not leave **paper** products, cooking utensils or food in the oven when not in use.
- Do not store flammable materials in the oven, or **the** broiler drawer or near the **cooktop**.
- Do not store or use combustible materials, gasoline or other flammable vapors and liquids in the vicinity of this or any other appliance.
- Do not let cooking grease or other flammable materials accumulate in or near the range.



- Do not use water on grease fires. Never pick up a flaming pan. Turn the controls off. Smother a flaming pan on a surface burner by covering the pan completely with a well-fitting lid, cookie sheet or flat tray. Use a multi-purpose dry chemical or foam-type fire extinguisher.

Flaming grease outside a pan can be put out by covering it with baking soda or, if available, by using a multi-purpose dry chemical or foam-type fire extinguisher.

Flame in the oven can be smothered completely by closing the oven door and turning the oven off or by using a multi-purpose dry chemical or foam-type fire extinguisher.

- When cooking pork, follow the directions exactly and always cook the meat to an internal temperature of at least 170°F. This assures that, in the remote possibility that trichina may be present in the meat, it will be killed and the meat will be safe to eat.

Surface Cooking

- Always use the **LITE** position when igniting top burners and make sure the burners have ignited.
- Never leave the surface burners unattended at high flame settings. Boilovers cause smoking and greasy spillovers that may catch on fire.
- Adjust the top burner flame size so it does not extend beyond the edge of the cookware. Excessive flame is hazardous.



- Use only dry pot **holders**—moist or damp pot holders on hot surfaces may result in burns from steam. Do not let pot holders come near open flames when lifting cookware. Do not use a towel or other bulky cloth. Such cloths can catch fire on a hot burner.
- To **minimize** the possibility of burns, ignition of flammable materials and spillage, turn cookware handles toward the side or back of the range without extending over adjacent burners.
- Always turn the surface burner controls off before removing cookware.
- Carefully watch foods being fried at a high flame setting.



Never block the vents (air openings) of the range. They provide the air inlet and outlet that are necessary for the range to operate properly with correct combustion. Air openings are located at the rear of the cooktop and at the top of the oven door.

- Do not use a wok on the cooking surface if the wok has a round metal ring that is placed over the burner grate to support the wok. This ring acts as a heat trap, which may damage the burner grate and burner head. Also, it may cause the burner to work improperly. This may cause a carbon monoxide level above that allowed by current standards, resulting in a health hazard.
- Foods for frying should be as dry as possible. Frost on frozen foods or moisture on fresh foods can cause hot fat to bubble up and over the sides of the pan.
- Use the least **possible amount of fat for effective shallow or deep-fat frying**. Filling the pan too full of fat can cause spillovers when food is added.
- If a combination of oils or fats will be used in frying, stir together before heating or as fats melt slowly.
- Always heat fat slowly, and watch as it heats.
- Use a deep fat thermometer whenever possible to prevent overheating fat beyond the smoking point.
- Never try to move a pan of hot fat, especially a deep fat fryer. Wait until the fat is cool.
- Never leave jars or cans of fat drippings on or near your range.
- Never **clean the cooktop** surface when it is hot. Some cleaners produce noxious fumes and wet cloths could cause steam burns if used on a hot surface.
- Use proper pan size—Avoid pans that are unstable or easily tipped. Select cookware having flat bottoms large enough to cover burner grates. To avoid spillovers, make sure cookware is large enough to contain the food properly. This will both save cleaning time and prevent hazardous accumulations of food, since heavy spattering or spillovers left on range can ignite. Use pans with handles that can be easily grasped and remain cool.
- When using glass cookware, make sure it is designed for top-of-range cooking.

- Keep all plastics away from the top burners.

- **Do not leave plastic items on the cooktop**—they may melt if close to the vent.

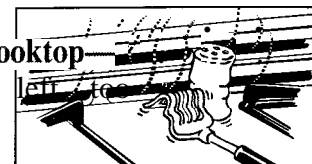

- Do not leave any items on the **cooktop**. The hot air from the vent may ignite flammable items and will increase pressure in closed containers, which may cause them to burst.
- To avoid the possibility of a burn, always be certain that the controls for all burners are at the off position and all grates are cool before attempting to remove them.
- When flaming foods are under the hood, turn the fan off. The fan, if operating, may spread the flames.
- If the range is located near a window, do not hang long curtains that could blow over the top burners and create a fire hazard.
- If you smell gas, turn off the gas to the range and call a qualified service technician. Never use an open flame to locate a leak.

Baking, Broiling and Roasting

- Do not use the oven for a storage area. Items stored in the oven can ignite.
- Stand away from the range when opening the door of a hot oven. The hot air and steam that escapes can cause burns to hands, face and eyes.
- Keep the oven free from grease buildup.
- Place the oven shelf in the desired position while the oven is cool.
- Pulling out the shelf to the shelf-stop is a convenience in lifting heavy foods. It is also a precaution against burns from touching hot surfaces of the door or oven walls.
- Do not heat unopened food containers in the oven. Pressure could build up and the container could burst, causing an injury.
- Do not **use aluminum foil anywhere in the oven except as described in this guide**. Misuse could result in a fire hazard or damage to the range.

(continued next page)



IMPORTANT SAFETY INSTRUCTIONS

(continued)

- When using cooking or roasting bags in the oven, follow the manufacturer's directions.
- Do not use your oven to dry newspapers. If overheated, they can catch fire.
- Use only glass cookware that is recommended for use in gas ovens.
- Always remove the broiler pan from the oven as soon as you finish broiling. Grease left in the pan can catch fire if oven is used without removing the grease from the broiler pan.
- Make sure the broiler pan and rack are in place correctly to reduce the possibility of a grease fire.
- When broiling, if meat is too close to the flames, the fat may ignite. Trim excess fat to prevent excessive flare-ups.
- If you should have a grease fire in the broiler pan, turn off oven, and keep oven door closed to contain fire until it burns out.

Cleaning Your Range

- Clean **only** parts listed in this Use and Care Guide.
- Keep range clean and free of accumulations of grease or **spillovers**, which may ignite.

SAVE THESE INSTRUCTIONS



FLOORING AND LEVELING

Flooring Under the Range

Your range, like so many other household items, is heavy and can settle into soft floor coverings such as cushioned vinyl or carpeting. When moving the range on this type of flooring, it should be installed on a 1/4-inch-thick sheet of plywood (or similar material) as follows:

When the floor covering ends at the front of the range, the area that the range will rest on should be built up with plywood to the same level or higher than the floor covering. This will allow the range to be moved for cleaning or servicing.

Leveling the Range

Use a 1 1/8" open-end or adjustable wrench to equally back out the four legs. The flanges (rims) below the sides of the cooktop must be raised above the top of the countertop. Carefully slide the range into its installation space. Observe that it is clearing the countertop. Then place a spirit level or a glass measuring cup partially filled with water on one of the oven shelves to check for levelness.

If using a spirit level, take two readings, with the level placed diagonally first in one direction and then the other.

Adjust the four legs carefully. Level the range front to back and side to side. The range legs must rest on the floor. The range **must not hang** from the countertop.

How to Remove Packaging Tape

To assure no damage is done to the finish of the product, the safest way to remove packaging tape adhesive on new appliances is an application of a household liquid dishwashing detergent, mineral oil or cooking oil. Apply with a soft cloth and allow to soak. Wipe dry and then apply an appliance polish to thoroughly clean and protect the surface.

NOTE: The plastic tape must be removed from the chrome trim on range parts. It cannot be removed if it is baked on.

Removing Packaging Materials

Check your range to insure all packaging materials and protective tape covering are removed from areas such as the door trim, cooktop frame, under burner caps, end caps, etc. before using.

FEATURES OF YOUR RANGE

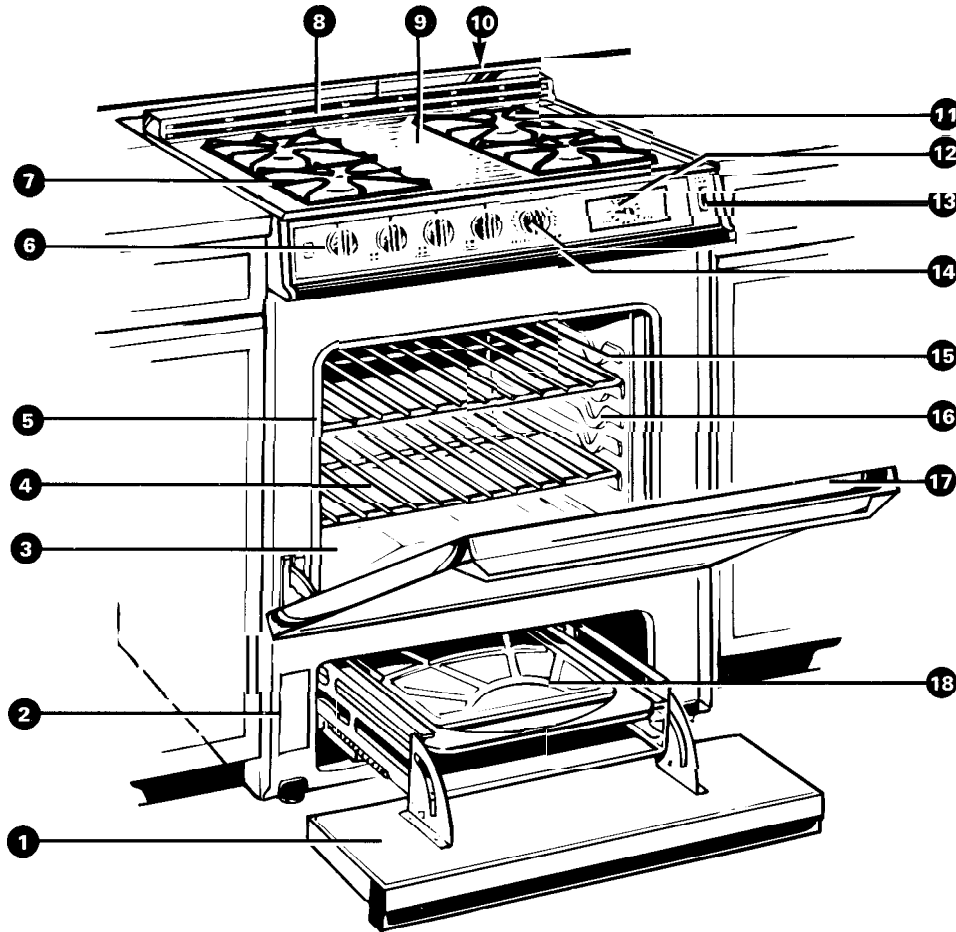

Flooring and Leveling

Heat Res of Your Range

Feature Index	Explained on page
1 Broiler Drawer	3, 17, 18, 22
2 Model and Serial Numbers	2
3 Removable Oven Bottom	23, 24
4 Oven Shelves with Stop-Locks	5, 11, 12, 14, 20
5 Continuous-Cleaning Oven Interior	24
6 Surface Burner Controls	8, 19
7 Surface Burners and Grates	8, 20, 21
8 Oven Vent	5, 11, 22
9 Lift-Up Cooktop Locks in up position to simplify cleaning underneath.	3, 19
10 Anti-Tip Device	2, 4, 25

Feature Index	Explained on page
11 Drip Pans	21
12 Clock and Timer	10
13 Oven Light Switch Lets you turn interior oven light on and off.	11
14 Oven Temperature Control	10
15 Oven Interior Light	11, 22
16 Oven Shelf Supports Shelf positions for cooking are suggested in the Baking and Roasting sections.	11, 12, 15
17 Lift-Off Oven Door Easily removed for oven cleaning.	21
18 Broiler Pan and Rack	5, 15, 17, 18, 22







HOW DOES THIS COOKTOP COMPARE WITH YOUR OLD ONE?

Your new cooktop has gas burners. If you are used to cooking with induction or other electric surface units, you will notice some differences when you use gas burners.

The best types of cookware to use, plus heat-up and cool-down times, depend upon the type of burner or surface unit you have.

The following chart will help you to understand the differences between gas burner cooktops and any other type of cooktop you may have used in the past.

Type of Cooktop	Description	How It Works
Gas Burners 	Regular or sealed gas burners use either LP gas or natural gas.	Flames heat the pans directly. Pan flatness is not critical to cooking results, but pans should be well balanced. Gas burners heat the pan right away and change heat settings right away. When you turn the control off, cooking stops right away.
Radiant (Glass Ceramic) Cooktop 	Electric coils under a glass-ceramic cooktop.	Heat travels to the glass surface and then to the cookware, so pans must be flat on the bottom for good cooking results. The glass cooktop stays hot enough to continue cooking after it is turned off. Remove the pan from the surface unit if you want cooking to stop.
Induction 	High frequency induction coils under a glass surface.	Pans must be made of ferrous metals (metal that attracts a magnet). Heat is produced by a magnetic circuit between the coil and the pan. Heats up right away and changes heat settings right away, like a gas cooktop. After turning the control off, the glass cooktop is hot from the heat of the pan, but cooking stops right away.
Electric Coil 	Flattened metal tubing containing electric resistance wire suspended over a drip pan.	Heats by direct contact with the pan and by heating the air under the pan. For best cooking results, use good quality pans. Electric coils are more forgiving of warped pans than radiant or solid disks. Heats up quickly but does not change heat settings as quickly as gas or induction. Electric coils stay hot enough to continue cooking for a short time after they are turned off.
Solid Disk 	Solid cast iron disk sealed to the cooktop surface.	Heats by direct contact with the pan, so pans must be flat on the bottom for good cooking results. Heats up and cools down more slowly than electric coils. The disk stays hot enough to continue cooking after it is turned off. Remove the pan from the solid disk if you want the cooking to stop.

SURFACE COOKING

Electric Ignition

Your surface burners are lit by electric ignition, eliminating the need for standing pilot lights with constantly burning flames.

In case of a power failure, you can light the surface burners on your range with a match. Hold a lit match to the burner, then push in and turn the control knob to the LITE position. **Use extreme caution when lighting burners in this manner.**

Surface burners in use when an electrical power failure occurs will continue to operate normally.

Surface Burner Controls

The knobs that turn the surface burners on and off are located on the lower control panel in front of the burners.

The two knobs on the left control the left front and left rear burners. The two knobs on the right control the right front and right rear burners.

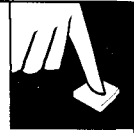

Light a Surface Burner

Push the control knob in and turn it **counterclockwise** to LITE. You will hear a little “clicking” noise—the sound of the electric spark igniting the burner.

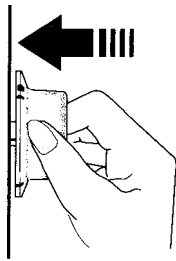

After the burner ignites, turn the knob to adjust the flame size.

After Lighting a Burner

Check to be sure the burner you turned on is the one you want to use.

Do not operate a burner for an extended period of time without cookware on the grate. The finish on the grate may chip without cookware to absorb the heat.

Be sure the burners and grates are cool before you place your hand, a pot holder, cleaning cloths or other materials on them.

How to Select Flame Size

Watch the flame, not the knob, as you reduce heat.

The flame size on a gas burner should match the cookware you are using. **FOR SAFE HANDLING OF COOKWARE, NEVER LET THE FLAME EXTEND UP THE SIDES OF THE COOKWARE.** Any flame larger than the bottom of the cookware is wasted and only serves to heat the handle.

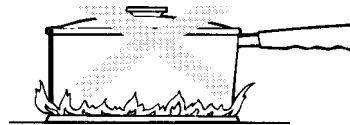

Top-of-Range Cookware

Aluminum: Medium-weight cookware is recommended because it heats quickly and evenly. Most foods brown evenly in an aluminum skillet. Use saucepans with tight-fitting lids for cooking with minimum amounts of water.

Cast Iron: If heated slowly, most skillets will give satisfactory results.

Enamelware: Under some conditions, the enamel of some cookware may melt. Follow cookware manufacturer’s recommendations for cooking methods.

Glass: There are two types of glass cookware—those for oven use only and those for top-of-range cooking (saucepans, coffee and teapots). Glass conducts heat very slowly.

Heatproof Glass Ceramic: Can be used for either surface or oven cooking. It conducts heat very slowly and cools very slowly. Check cookware manufacturer’s directions to be sure it can be used on gas ranges.

Stainless Steel: This metal alone has poor heating properties, and is usually combined with copper, aluminum or other metals for improved heat distribution. Combination metal skillets usually work satisfactorily if they are used with medium heat as the manufacturer recommends.



CLOCK AND TIMER

To Set the Clock

Push in the knob and turn the clock hands to the right to the correct time. Then let the knob out and continue turning to OFF.

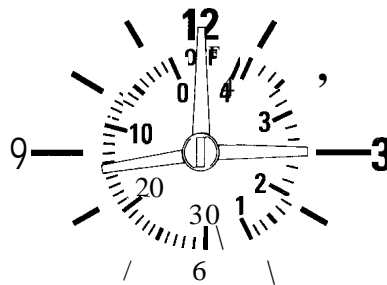

Timer

The Timer has been combined with the range clock. Use it to time all your precise cooking operations. You'll recognize the Timer as the pointer which is different in color than the clock hands.

Minutes are marked up to 30 (can be set for up to 45 minutes) and hours are marked up to 4 on the center ring of the clock.

To set the Timer, turn the knob to the left, without pushing in, until the pointer reaches the number of minutes or hours you want to time.

At the end of the set time, a buzzer sounds to tell you time is up. Turn the knob, without pushing in, until the pointer reaches OFF and the buzzer stops.

USING YOUR OVEN

Before Using Your Oven

1. Look at the controls. Be sure you understand how to set them properly.
2. Check the oven interior. Look at the shelves. Take a practice run at removing and replacing them properly to give sure, sturdy support.
3. Read over the information and tips that follow.
4. Keep this guide handy so you can refer to it especially during the first weeks of using your new range.

Electric Ignition

The oven burner and broil burner on your range are lit by electric ignition.

To light the burner, turn the OVEN TEMP knob to the desired temperature. The burner should light within 60 seconds. You will hear a little clicking noise—the sound of the electric spark igniting the burner.

Power Outage

CAUTION: DO NOT MAKE ANY ATTEMPT TO OPERATE THE ELECTRIC IGNITION OVEN DURING AN ELECTRICAL POWER OUTAGE. Neither the oven nor the broiler can be lit during an electrical power outage.

If the oven is in use when a power outage occurs, the oven burner shuts off and cannot be re-lit until power is restored.

Oven Moisture

As your oven heats up, the temperature change of the air in the oven may cause water droplets to form on the door glass. These droplets are harmless and will evaporate as the oven continues to heat up.



Oven Shelves

The shelves are designed with stop-locks so when placed correctly on the shelf supports, they will stop before coming completely out of the oven and will not tilt when you are removing food from them or placing food on them.

When placing cookware on a shelf, pull the shelf out to the bump on the shelf support. Place the cookware on the shelf, then slide the shelf back into the oven. This will eliminate reaching into the hot oven.

To remove a shelf from the oven, pull it toward you, tilt the front end upward and pull the shelf out.

To replace, place the shelf on the shelf support with stop-locks (the curved extension of the shelf) facing up and toward the rear of the oven. Tilt up the front and push the shelf toward the back of the oven until it goes past the bump on the shelf support. Then lower the front of the shelf and push it all the way back.

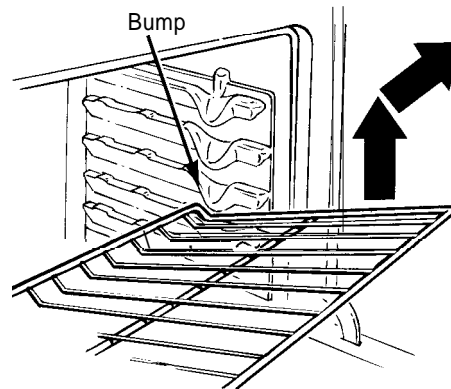

Shelf Positions

The oven has four shelf supports identified in this illustration as A (bottom), B, C and D (top).

Shelf positions for cooking are suggested in the Baking and Roasting sections.

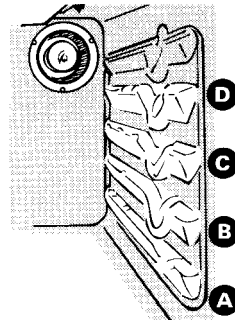

Oven Vent

Your oven is vented through duct openings at the center rear of the range. Do not block these ducts when cooking in the oven—it is important that the flow of hot air from the oven and fresh air to the oven burner be uninterrupted. Avoid touching the vent openings or nearby surfaces during oven or broiler operation—they may become hot.

- Vent openings and nearby surfaces may become hot. Do not touch them.
- Handles of pots and pans on the cooktop may become hot if left too close to the vent.

- Do not leave plastic items on the cooktop—they may melt if left too close to the vent.
- Do not leave any items on the cooktop. The hot air from the vent may ignite flammable items and will increase pressure in closed containers, which may cause them to burst.
- Metal items will become very hot if they are left on the cooktop, and could cause burns.

Oven Light

Use the switch on the control panel to turn the light on and off.



BAKING

Your oven temperature is controlled very accurately using an oven control system. It is recommended that you operate the range for a number of weeks to become familiar with you new oven's performance.

If you think an adjustment is necessary, see the Adjust the Oven Thermostat section. It lists easy *Do It Yourself* instructions on how to adjust the thermostat.

NOTE: When the oven is hot, the top and outside surfaces of the range get hot too.

How to Set Your Range for Baking

To avoid possible burns, place the shelves in the correct position before you turn the oven on.

1. Close the oven door, turn the OVEN TEMP knob to the desired temperature and preheat the oven for at least 10 minutes if preheating is necessary.

2. Check food for doneness at minimum time on recipe. Cook longer if necessary.

3. Turn the OVEN TEMP knob to OFF and then remove the food from the oven.

Oven Shelves

Arrange the oven shelf or shelves in the desired locations while the oven is cool. The correct shelf position depends on the kind of food and the browning desired. As a general rule, place most foods in the middle of the oven, on either shelf position B or C. See the chart for suggested shelf positions.

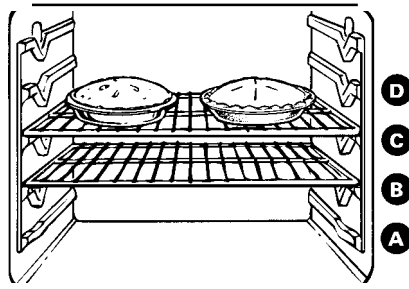

Type of Food	Shelf Position
Angel food cake	A
Biscuits or muffins	B or C
Cookies or cupcakes	B or C
Brownies	B or C
Layer cakes	B or C
Bundt or pound cakes	A or B
Pies or pie shells	B or C
Frozen pies	A (on cookie sheet)
Casseroles	B or C
Roasting	A or B

Preheating

Preheating is necessary for good results when baking cakes, cookies, pastry and breads. For most casseroles and roasts, preheating is not necessary. For ovens without a preheat indicator light or tone, preheat 10 minutes. After the oven is preheated, place the food in the oven as quickly as possible to prevent heat from escaping.

Preheat the oven if the recipe calls for it. Preheat means bringing the oven up to the specified temperature before putting the food in the oven. To preheat, set the oven at the correct temperature—selecting a higher temperature does not shorten preheat time.

Baking Pans

Use the proper baking pan. The type of finish on the pan determines the amount of browning that will occur.

- Dark, rough or dull pans absorb heat resulting in a browner, crisper crust. Use this type for pies.
- Shiny, bright and smooth pans reflect heat, resulting in a lighter, more delicate browning. Cakes and cookies require this type of pan.
- Glass baking dishes absorb heat. When baking in glass baking dishes, the temperature may need to be reduced by 25°F.
- If you are using dark non-stick pans, you may find that you need to reduce the oven temperature 25°F. to prevent overbrowning.



an Placement

For even cooking and proper browning, there must be enough room for air circulation in the oven. Baking results will be better if baking pans are centered as much as possible rather than being placed to the front or to the back of the oven.

Pans should not touch each other or the walls of the oven. Allow 1- to 1½-inch space between pans as well as from the back of the oven, the door and the sides. If you need to use two shelves, stagger the pans so one is not directly above the other.

Baking Guides

When using prepared baking mixes, follow the package recipe or instructions for the best baking results.

Cookies

When baking cookies, flat cookie sheets (without sides) produce better-looking cookies. Cookies baked in a jelly roll pan (short sides all around) may have darker edges and pale or light browning may occur.

Do not use a cookie sheet so large that it touches the walls or the door of the oven. Never entirely cover a shelf with a large cookie sheet.

For best results, use only one cookie sheet in the oven a time.

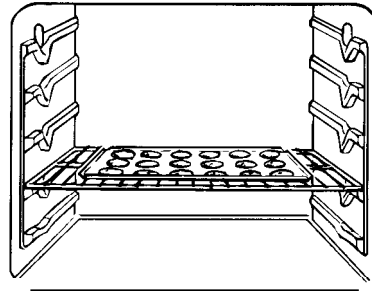

Cakes

When baking cakes, warped or bent pans will cause uneven baking results and poorly shaped products. A cake baked in a pan larger than the recipe recommends will usually be crisper, thinner and drier than it should be. If baked in a pan smaller than recommended, it may be undercooked and batter may overflow. Check the recipe to make sure the pan size used is the one recommended.

Pies

For best results, bake pies in dark, rough or dull pans to produce a browner, crisper crust. Frozen pies in foil pans should be placed on an aluminum cookie sheet for baking since the shiny foil pan reflects heat away from the pie crust; the cookie sheet helps retain it.

(continued next page)



BAKING

(continued)

Aluminum Foil

Never entirely cover a shelf with aluminum foil. This will disturb the heat circulation and result in poor baking. A smaller sheet of foil may be used to catch a spillover by placing it on a lower shelf several inches below the food.

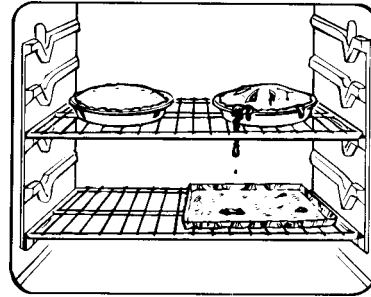

Don't Peek

Set the timer for the estimated cooking time and do not open the door to look at your food. Most recipes provide minimum and maximum baking times such as "bake 30-40 minutes."

DO NOT open the door to check until the minimum time. Opening the oven door frequently during cooking allows heat to escape and makes baking times longer. Your baking results may also be affected.

ADJUST THE OVEN THERMOSTAT—*DO IT YOURSELF!*

You may find that your new oven cooks differently than the one it replaced. We recommend that you use your new oven for a few weeks to become more familiar with it, following the times given in your recipes as a guide.

If you think your new oven is too hot or too cold, you can adjust the thermostat yourself. If you think it is too hot, adjust the thermostat to make it cooler. If you think it is too cool, adjust the thermostat to make it hotter.

We do not recommend the use of inexpensive thermometers, such as those found in grocery stores, to check the temperature setting of your new oven. These thermometers may vary 20-40 degrees.

To Adjust the Thermostat: Bottom screw moves toward

1. Pull the OVEN TEMP knob off the shaft, look at the back of the knob and note the current setting before making any adjustment. The knob is factory set with the top screw directly under the pointer.

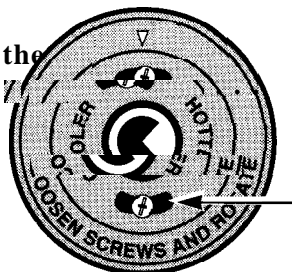

Back of the OVEN TEMP knob

- Loosen both screws on back of the knob.
- Hold the knob as shown in the illustration of the back of the OVEN TEMP knob and turn so the bottom screw moves in the desired direction. You will hear and feel notches as you turn the knob. Each notch changes the temperature about 10° Fahrenheit.

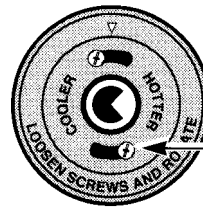

The bottom screw moves toward HOTTER to increase the temperature.

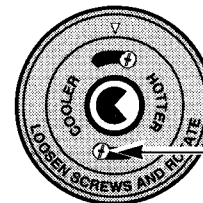

The bottom screw moves toward COOLER to decrease the temperature.

- Tighten the screws.
 - Return the knob to the range.
- Re-check oven performance before making any additional adjustments.

ROASTING



Roasting is cooking by dry heat. Tender meat or poultry can be roasted uncovered in your oven. Roasting temperatures, which should be low and steady, keep spattering to a minimum.

Roasting is really a baking procedure used for meats. Therefore, the oven controls are set to Baking. (You may hear a slight clicking sound, indicating the oven is working properly.)

Most meats continue to cook slightly while standing after being removed from the oven. The standing time recommended for roasts is 10 to 20 minutes to allow the roast to firm up, making it easier to carve. The internal temperature will rise about 5° to 10°F.; to compensate for the temperature rise, if desired, remove the roast from the oven sooner at 5° to 10°F. less than the temperature on the guide.

Remember that food will continue to cook in the hot oven and therefore should be removed when the desired internal temperature has been reached.

1. Position the oven shelf at the second from the bottom position (B) for a small size roast (3 to 5 lbs.) and at the bottom position (A) for larger roasts.
2. Check the weight of the meat. Place meat fat-side-up or poultry breast-side-up on roasting rack in a shallow pan. The melting fat will baste the meat. Select a pan as close to the size of the meat as possible. (The broiler pan with rack is a good pan for this.)
3. Turn the OVEN TEMP knob to the desired temperature. See the Roasting Guide for temperatures and approximate cooking times.
4. When roasting is complete, turn the OVEN TEMP knob to OFF and then remove the food from the oven.

Use of Aluminum Foil

You can use aluminum foil to line the broiler pan. This makes clean-up easier when using the pan for marinating, cooking with fruits, cooking heavily cured meats or basting food during cooking. Press the foil tightly around the inside of the pan.

(continued next page)

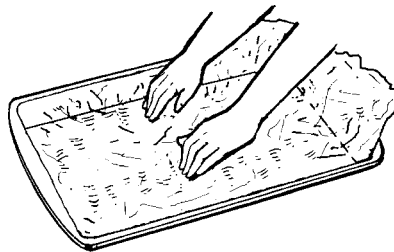



ROASTING

(continued)

Questions and Answers

Q. Is it necessary to check for doneness with a meat thermometer?

A. Checking the finished internal temperature at the completion of cooking time is recommended. Temperatures are shown in the Roasting Guide section. For roasts over 8lbs., check with thermometer at half-hour intervals after half the cooking time has passed.

Q. Why is my roast crumbling when I try to carve it?

A. Roasts are easier to slice if allowed to cool 10 to 20 minutes after removing them from the oven. Be sure to cut across the grain of the meat.

Q. Do I need to preheat my oven each time I cook a roast or poultry?

A. It is not necessary to preheat your oven.

Q. When buying a roast, are there any special tips that would help me cook it more evenly?

A. Yes. Buy a roast as even in thickness as possible, or buy rolled roasts.

Q. Can I seal the sides of my foil "tent" when roasting a turkey?

A. Sealing the foil will steam the meat. Leaving it unsealed allows the air to circulate and brown the meat.

ROASTING GUIDE

Frozen Roasts

Frozen roasts of beef, pork, lamb, etc., can be started without thawing, but allow 10 to 25 minutes per pound additional time (10 minutes per pound for roasts under 5 pounds, more time for larger roasts).

Make sure poultry is thawed before roasting. Unthawed poultry often does not cook evenly. Some commercial frozen poultry can be cooked successfully without thawing. Follow the directions given on the package label.

Type	Oven Temperature	Doneness	Approximate Roasting Time in Minutes per Pound		Internal Temperature °F.
Meat					
Tender cuts; rib, high quality sirloin tip, rump or top round*	325°	Rare: Medium: Well Done:	3 to 5 lbs. 24-33 35-39 40-45	6 to 8 lbs. 18-22 22-29 30-35	1400-150°† 150°-1600 170°-185°
Lamb leg or bone-in shoulder*	325°	Rare: Medium: Well Done:	21-25 25-30 30-35	20-23 24-28 28-33	140°-1500t 1500-1600 1700-185°
Veal shoulder, leg or loin*	325°	Well Done:	35-45	30-40	170°-1800
Pork loin, rib or shoulder*	325°	Well Done:	35-45	30-40	1700-180°
Ham, precooked	325°	To Warm:	17-20 minutes per pound (any weight)		115°-120°
Poultry					
Chicken or Duck	325°	Well Done:	3 to 5 lbs. 35-40	Over 5 lbs. 30-35	1850-1900
Chicken pieces	350°	Well Done:	35-40		1850-190°
Turkey	325°	Well Done:	10 to 15 lbs. 18-25	Over 15 lbs. 15-20	In thigh: 185°-1900

*For boneless rolled roasts over 6 inches thick, add 5 to 10 minutes per pound to times given above.

†The U.S. Department of Agriculture says "Rare beef is popular, but you should know that cooking it to only 140°F. means some food poisoning organisms may survive." (Source: Safe Food Book. Your Kitchen Guide. USDA Rev. June 1985.)

BROILING



Broiling is cooking food by direct heat from above the food. Your range has a convenient compartment below the oven for broiling. It also has a specially designed broiler pan and rack that allows dripping fat to drain away from the foods and be kept away from the high heat of the gas flame.

Distance from the heat source may be changed by positioning the broiler pan and rack on one of three shelf positions in the broiler compartment—A (bottom of broiler compartment), B (middle) and C (top).

Both the oven and broiler compartment doors should be closed during broiling.

Turn most foods using tongs once during cooking; (the exception is thin fillets of fish; oil one side, place that side down on the broiler rack and cook without turning until done). Time the foods for about one-half the total cooking time, turn the food, then continue to cook to the preferred doneness.

1. If the meat has fat or gristle around the edge, cut vertical slashes through it about 2 inches apart. If desired, the fat may be trimmed, leaving a layer about 1/8-inch thick.
2. Remove the broiler pan and rack from the broiler compartment and place the food on the rack.
3. Pull out the broiler drawer and position the broiler pan on the preferred rack position in the compartment placing the sump area of the broiler pan to the front of the drawer.

Placing the food closer to the flame increases the exterior browning of the food, but also increases the spattering and the possibility of the fats and meat juices igniting.

4. Close the broiler door and turn the OVEN TEMP knob to BROIL.
5. Turn the OVEN TEMP knob to OFF. Remove the broiler pan from the compartment and serve the food immediately. Leave the pan outside the compartment to cool.

Use of Aluminum Foil

You can use aluminum foil to line your broiler pan and broiler rack. However, you must mold the foil tightly to the rack and cut slits in it just like the rack.

Without the slits, the foil will prevent fat and meat juices from draining into the broiler pan. The juices could become hot enough to catch on fire. If you do not cut the slits, you are frying, not broiling.

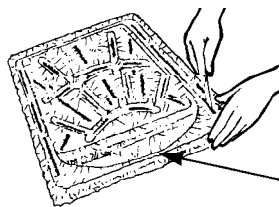

Always place sump to the front of the drawer.

Broiling Tips

- Use tongs to turn the meat over—pierced meat loses juices.
- Steaks and chops should be at least 1-inch thick for best broiling results. Pan broil thinner ones.

Questions and Answers

Q. Why are meats not turning out as brown as they should?

A. Check to see if you are using the recommended shelf position. Broil for the longest period of time indicated in the Broiling Guide. Turn the food only once during broiling.

Q. Should I salt the meat before broiling?

A. No. Salt draws out the juices and allows them to evaporate. Always salt after cooking. Piercing the meat with a fork also allows juices to escape. Turn the meat with tongs instead of a fork.

Q. When broiling, is it necessary to always use a rack in the pan?

A. Yes. Using the rack suspends the meat over the pan. As the meat cooks, the juices fall into the pan, thus keeping meat drier. Juices are protected by the rack and stay cooler, thus preventing excessive spatter and smoking.

(continued next page)



BROILING GUIDE

- Always use the broiler pan and rack that comes with your oven. It is designed to minimize smoking and spattering by trapping the juices in the shielded lower part of the pan.
- For steaks and chops, slash fat evenly around the outside edges of the meat. To slash, cut crosswise through outer fat surface just to the edge of the meat. Use tongs to turn the meat over to prevent piercing the meat and losing juices.
- If desired, marinate meats or chicken before broiling. Or brush with barbecue sauce last 5 to 10 minutes only.
- When arranging the food on the pan, do not let fatty edges hang over the sides because dripping fat will soil the oven.
- Broiler does not need to be preheated. However, for very thin foods, or to increase browning, preheat if desired.
- Frozen steaks can be conventionally broiled by positioning the oven shelf at next lowest shelf position and increasing cooking time given in this guide 1½ times per side.

Food	Quantity and/or Thickness	Broil Position	First Side Time, Minutes	Second Side Time, Minute:	Comments
Bacon	1/2-lb. (about 8 thin slices)	B	3½	3	Arrange in single layer.
Ground Beef Well Done	1-lb. (4 patties) 1/2 to 3/4-inch thick	B	8-9	6-7	Space evenly. Up to 8 patties take about same time.
Beef Steaks Rare	1-inch thick (1-1X lbs.)	B	9	7	Steaks less than 1-inch cook through before browning. Pan frying is recommended.
Medium		B	12	5-6	
Well Done		B	13	8-9	
Rare	1 ½-inch thick (2-2½ lbs.)	B, C	10	6-7	Slash fat.
Medium		B	15	12-14	
Well Done		B	25	16-18	
Chicken	1 whole (2 to 2½-lbs.), split lengthwise	A	30-35	25-30	Reduce times about 5 to 10 minutes per side for cut-up chicken. Brush each side with melted butter. Broil with skin-side-down first.
Bakery Products Bread (Toast) or Toaster Pastries	2-4 slices 1 pkg. (2) 2-split	C	2-3	1/2-1	Space evenly. Place English muffins cut-side-up and brush with butter, if desired.
English Muffins		C	3-5		
Lobster Tails	2-4 (6 to 8-oz. each)	B	13-16	Do not turn over.	Cut through back of shell, spread open. Brush with melted butter before broiling and after half of broiling time.
Fish	1-lb. fillets 1/4 to 1/2-inch thick	B, C	5	5	Handle and turn very carefully. Brush with lemon butter before and during cooking, if desired. Preheat broiler to increase browning.
Ham Slices Precooked	1-inch thick	B	8	8	Increase times 5 to 10 minutes per side for 1 ½-inch thick or home cured.
Pork Chops Well Done	2 (1/2-inch) 2 (1-inch thick), about 1 lb.	B B	10 13	4-5 9-12	Slash fat.
Lamb Chops Medium	2 (1-inch) about 10-1 2 oz. 2 (1 k-inch), about 1 lb.	B	8	4-7	Slash fat.
Well Done		B	10	10	
Medium		B	10	4-6	
Well Done		B	17	12-14	
Wieners, similar precooked sausages, bratwurst	1-lb. pkg. (10)	B, C	6	1-2	If desired, split sausages in half lengthwise; cut into 5-to 6-inch pieces.

CARE AND CLEANING

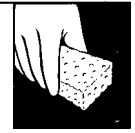

Proper care and cleaning are important so your range will give you efficient and satisfactory service. Follow these directions carefully in caring for it to help assure safe and proper maintenance.

BE SURE ELECTRICAL POWER IS OFF BEFORE CLEANING ANY PART OF THE RANGE.

Control Panel and Knobs

Clean up any spills or splatters with a damp cloth. Remove heavier soil with warm, soapy water.

Clean the control panel with mild liquid dish detergent and a soft cloth. Rub the control panel lightly. **CAUTION:** Do not use abrasives of any kind on the control panel.

The control knobs may be removed for easier cleaning.

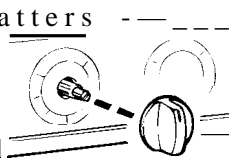

Before removing the knobs for cleaning, please note that the knobs on the left side and the knobs on the right side are in the proper OFF position. When replacing the knobs, check the OFF position to insure proper alignment.

To remove the knob, pull it straight off the stem. When removing a knob, it may be helpful to slip a thin cloth (such as a handkerchief or a piece of string under and around the knob edge) and pull up.

Wash the knobs in soap and water but do not soak. Dry and return the control knobs to the range.

Brushed Chrome Cooktop

Clean the brushed chrome top with warm, soapy water. Use an Ami® brand cleanser and immediately dry it with a clean, soft cloth. Take care to dry the surface following the "grain." To help prevent finger marks after cleaning, spread a thin film of baby oil on the surface. Wipe away excess oil with a clean, soft cloth.



Lift-Up Cooktop

Clean the area under the cooktop often. Built-up soil, especially grease, may catch fire.

To make cleaning easier, the entire cooktop may be lifted up and supported in the up position.

Be sure all burners are turned off before raising the cooktop. Then remove the grates and drips pans, grasp the two front burners wells and lift up. Dual support rods will hold the cooktop up while you clean underneath it.

After cleaning under the cooktop with hot, soapy water and clean cloth, lower the cooktop. Be careful not to pinch your fingers.

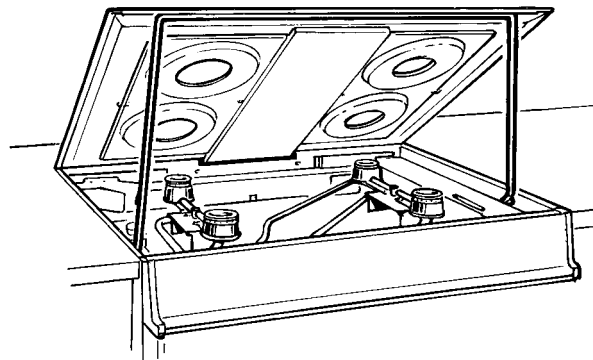

(continued next page)

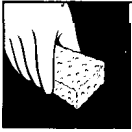

CARE AND CLEANING

Oven Shelves

Clean the shelves with a mild abrasive cleanser or steel wool. After cleaning, rinse the shelves with clean water and dry with a clean cloth.

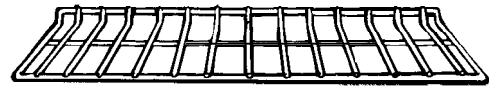

Range Top Burners

The holes in the burners must be kept clean at all times for proper ignition and an even, unhampered flame.

You should clean the burners routinely, especially after bad spillovers which could clog these holes. Burners lift out for cleaning if the shipping screws were removed at installation.

NOTE: A screw holds each burner in place to keep them from wobbling around during shipment. Remove and discard the shipping screws. Be careful not to remove the screws from the igniter bracket.

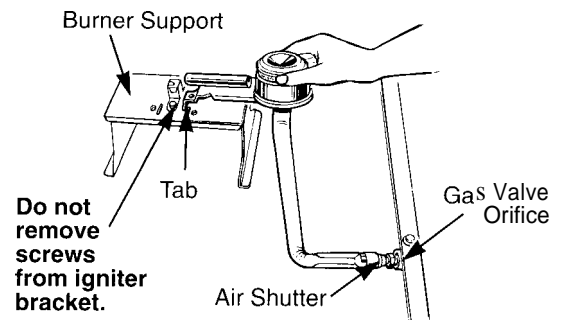

To remove the burners:

1. Grasp the burner head and tilt it to the right to release the two tabs from slots in the burner support.
2. Lift the end of the burner assembly, then pull away from the front of the range to free the air shutter from the gas valve orifice.

To remove burned-on food, soak the burners in a solution of mild liquid detergent and water. Soak the burners for 20 to 30 minutes. If the food doesn't rinse off completely, scrub them with soap and water and a brush or plastic pad. Do not use steel wool or abrasive cleansers because they will clog the burner openings and scratch the burners. If the holes become clogged, clean them with a small sewing needle or a small safety pin.

Do not attempt to clean burners in an automatic dishwasher. Loosened food soil can clog burner holes, and the strong action of the dishwasher detergent can damage the burner heads.

Before putting the burners back, shake out excess water and dry them thoroughly by setting them in a warm oven for 30 minutes.

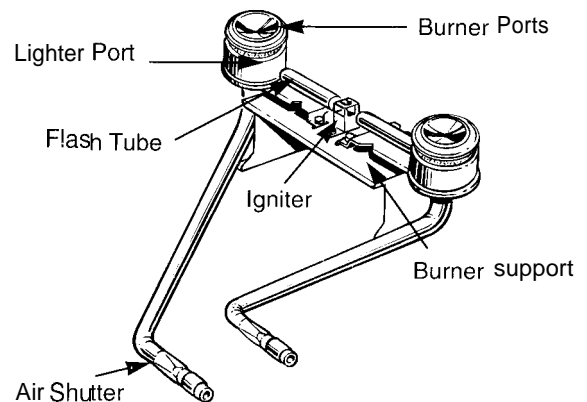

To replace the burners:

1. Slip the air shutter over the gas valve orifice.
2. Lower the burner assembly and hook the tabs in the slots in the burner support.
3. Be sure both tabs are in their slots, that the burner sits level and straight, and that the flash tube forms a straight line from the igniter to the burner.



Burner Grates

Porcelain enamel burner grates should be washed regularly and, of course, after spillovers. Wash them in hot, soapy water and rinse with clean water. Dry the grates with a cloth—don't put them back on the range wet. When replacing the grates, be sure they're positioned securely over the burners.



To get rid of burned-on food, place the grates in a covered container or plastic bag. Add 1/4 cup ammonia and let them soak for 30 minutes. Wash, rinse well and dry.

Although they're durable, the grates will gradually lose their shine, regardless of the best care you can give them. This is due to their continual exposure to high temperatures.

Do not operate a burner for an extended period of time without cookware on the grate. The finish on the grate may chip without cookware to absorb the heat.

Drip Pans

Remove the grates. Then lift out the chrome-plated drip pans. Wash them in hot, soapy water. Rinse them with clean, hot water and polish them dry with a cloth. Never use abrasive cleansers or steel wool—they'll scratch the surface. Instead, soak the drip pans for about 20 minutes in slightly diluted liquid cleanser or mild solution of ammonia and water (1/2 cup of ammonia to one gallon of water).

After soaking, wash them in hot, soapy water. Rinse with clean water and polish with a clean, soft cloth.

The drip pans may also be cleaned in the dishwasher.

Lift-Off Oven Door

The oven door is removable, but it's heavy. You may need help moving and replacing the door. Do not lift the door by the handle. This can cause the glass to break or can cause damage to the door.

To **remove the door**, open it a few inches to the special stop position that will hold the door open. Grasp firmly on each side and lift the door straight up and off the hinges.

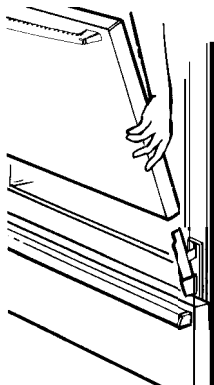

NOTE:

- Be careful not to place hands between the hinge and the oven door frame as the hinge could snap back and pinch fingers.
- While working in the oven area, cover the hinges with towels or empty paper towel rolls to prevent pinched fingers and chipping the porcelain enamel on the frame.

To **replace the door**, make sure the hinges are in the special stop position. Position the slots in the bottom of the door squarely over the hinges at the same time. If the hinges snap back against the oven frame, pull them back out.

TO CLEAN THE DOOR:

Inside of door:

- **Soap and water will normally do the job.** Heavy spattering or spillovers may require cleaning with a mild abrasive cleaner. Soapy, wet metal pads may also be used. Do not allow food spills with a high sugar or acid content (such as milk, tomatoes, sauerkraut, fruit juices or pie filling) to remain on the surface. They may cause a dull spot even after cleaning.
- **If necessary, you may use an oven cleaner.** Follow the package directions. Do not use oven cleaners, cleansing powders or harsh abrasives on the outside of the door.

Outside of door:

- Use soap and water to thoroughly clean the top, sides and front of the oven door. DO NOT let water run down through openings in the top of the door. Rinse well. You may also use a glass cleaner to clean the glass on the outside of the door.
- Spillage of marinades, fruit juices, tomato sauces and basting materials containing acids may cause discoloration and should be wiped up immediately. When the surface is cool, clean and rinse.

(continued next page)

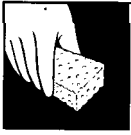

CARE AND CLEANING

(continued)

Oven Light Bulb

The light bulb is located in the upper right corner of the oven. Before replacing the bulb, disconnect electrical power to range at the main fuse or circuit breaker panel or unplug the range from the electrical outlet. Let the bulb cool completely before removing it. Do not touch a hot bulb with a damp cloth as the bulb will break.

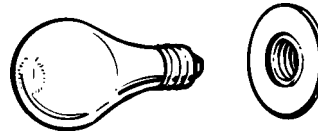

Broiler Pan and Rack

After broiling, remove the broiler pan from the broiler drawer. Remove the rack from the pan. Carefully pour out grease from the pan into a proper container. Wash and rinse the broiler pan and rack in hot water with a soap-filled or plastic scouring pad.

If food has burned on, sprinkle the rack with detergent while hot and cover with wet paper towels or a dishcloth. Soaking the pan will remove burned on foods.

Both the broiler pan and rack may be cleaned with a commercial oven cleaner.

Both the broiler pan and rack can also be cleaned in the dishwasher.

Do not store a soiled broiler pan and rack anywhere in the range.

Broiler Drawer

To remove:

1. When the broiler is cool, remove the rack and pan.
2. Pull the broiler drawer out until it stops, then push it back in about one inch.
3. **Grasp the handle, lift and pull the broiler drawer out (lift the rollers located under the drawer over the roller guides in the range).**

To replace:

1. Put the rollers under the broiler drawer behind the roller guide stops in the range.
2. Hold the broiler drawer in the raised position as you slide it partway into the range. Then lower the drawer and push it completely closed.

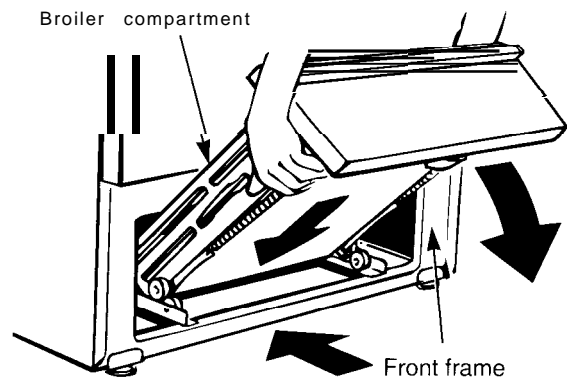

Oven Vent

The oven is vented through an opening at the rear of the cooktop. Never cover the opening with aluminum foil or any other material. This would prevent the oven vent from working properly.

Clean the oven vent grille with Bon Ami®.



movable Oven Bottom

The oven bottom can be removed to make cleaning easier.

To remove:

1. Grasp the oven bottom at finger slots on each side.
2. Lift front edge of **the oven bottom** enough to raise the tabs from slots in the front frame.
3. Push the oven bottom back about 1/4" to release the flange from the front frame, then pull out.

To replace the oven bottom:

1. Slide the oven bottom into the oven so rear tabs fit into slots in the rear wall of the oven.
2. **Grasp the oven bottom at finger slots and push it back and then down** to hook the flange under the front frame.
3. **Fit the front tabs into slots in front frame.**

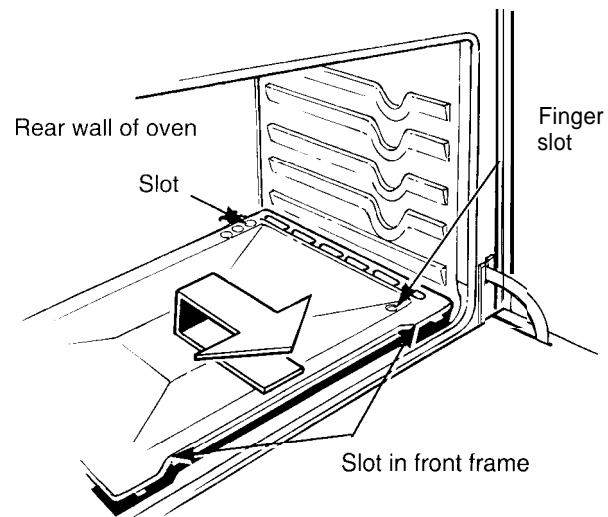

The oven bottom has a porcelain enamel finish.

To make cleaning easier, protect the oven bottom from excessive spillovers. This is particularly important when baking a fruit pie or other foods with high acid content. Hot fruit fillings or foods that are high in acid content such as milk, tomato or sauerkraut and sauces with vinegar or lemon juice, may cause pitting and damage to the porcelain enamel surface.

To protect the oven bottom surface, place a piece of aluminum foil slightly larger than the baking dish on the shelf below to catch any boilovers. It should not completely cover the shelf as this would cause uneven heat in the oven. Aluminum foil should not be placed on the oven bottom.

If a spillover does occur on the oven bottom, allow the oven to cool first. Remove the oven bottom for easier cleanup and to prevent damage to the continuous cleaning oven coating.

Frequent wipings with mild soap and water (particularly after cooking meat) will prolong the time between major cleanings. Rinse thoroughly. Soap left on the oven bottom can cause stains.

For heavy soil, use a mild abrasive cleaner and follow label instructions, using a thin layer of cleaner. Use of rubber gloves is recommended. Wipe or rub lightly on stubborn spots. A commercial oven cleaner may also be used, following package directions.

Painted Surfaces

Painted surfaces include the control panel and drawer front. Clean these with soap and water or a vinegar and water solution. Do not use commercial oven cleaners, cleansing powders, steel wool or harsh abrasives on any painted surface.

(continued next page)

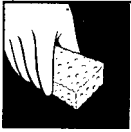

CARE AND CLEANING

(continued)

Continuous-Cleaning Oven Interior

Special Care of Continuous-Cleaning Oven Interior:

Do not attempt to clean the oven until you have read this section.

The Continuous-Cleaning Oven cleans itself while cooking. The oven interior is finished with a special coating that cannot be cleaned in the usual manner with soap, detergents, steel wool pads, commercial oven cleaners, coarse abrasive pads or coarse brushes. Use of such cleansers and/or the use of oven sprays will cause permanent damage.

The special coating is a porous ceramic material, which is dark in color and feels slightly rough to the touch. If magnified, the surface would appear as peaks, valleys and sub-surface "tunnels." This rough finish tends to prevent grease spatters from forming little beads or droplets that run down the side walls of a hard-surface oven liner, leaving unsightly streaks that require hand cleaning. Instead, when spatter hits the porous finish, it is dispersed and partially absorbed. This spreading action increases the exposure of oven soil to heated air and makes it somewhat less noticeable.

Soil may not disappear completely and at some time after extended usage, stains may appear that cannot be removed.

The special coating works best on small amounts of spatter. It does not work well with larger spills, especially sugars, egg or dairy mixtures.

This special coating is not used on the oven shelves, the oven bottom or on the inside of the oven door. Remove these to clean with a commercial oven cleaner to prevent damaging the Continuous-Cleaning Oven coating.

Use care in removing and replacing the shelves and dishes in order to avoid scratching, rubbing or otherwise damaging the porous finish on the oven walls.

To Clean the Continuous-Cleaning Oven:

1. Let range parts cool before handling. We recommend rubber gloves be worn when cleaning.
2. Remove shelves and cookware, including the broiler pan and rack.
3. Soil visibility may be reduced by operating the oven at 400°F. Close the door and set temperature control to 400°F. Time for at least 4 hours. Repeated cycles may be necessary before improvement in appearance is apparent.

Remember: During the operation of the oven, the door, window and other range surfaces will get hot enough to cause burns. Do not touch. Let the range cool before replacing the oven shelves.

4. If a spillover or heavy soiling occurs on the porous surface, as soon as the oven has cooled, remove as much of the soil as possible using a small amount of water and a stiff-bristle nylon brush. Use water sparingly and change it frequently, keeping it as clean as possible, and be sure to blot it up with paper towels, cloths or sponges. Do not rub or scrub with paper towels, cloths or sponges, since they will leave unsightly lint on the oven finish. If water leaves a white ring on the finish as it dries, apply water again and blot it with a clean sponge, starting at the edge of the ring and working toward the center.

Do not use soap, detergent, steel wool pads, commercial oven cleaner, silicone oven sprays, coarse pads or coarse brushes on the porous surface. These products will spot, clog and damage the porous surface and reduce its ability to work.

Do not scrape the porous surface with a knife or spatula— they could permanently damage the finish.

ANTI-TIP DEVICE



Before placing range in the counter, notice the location of the stability bracket which is already attached to the back of the range. This location should work for most installations. However, it may be more convenient to hook the stability chain to the unit when the stability bracket is attached to the upper set of holes in the back of the range. See Fig. A. The upper level set of holes are intended for use with a backsplash kit. If the backsplash is not being used, make sure that there are no structural supports for the countertop which will interfere with the stability bracket when located in the upper set of holes.

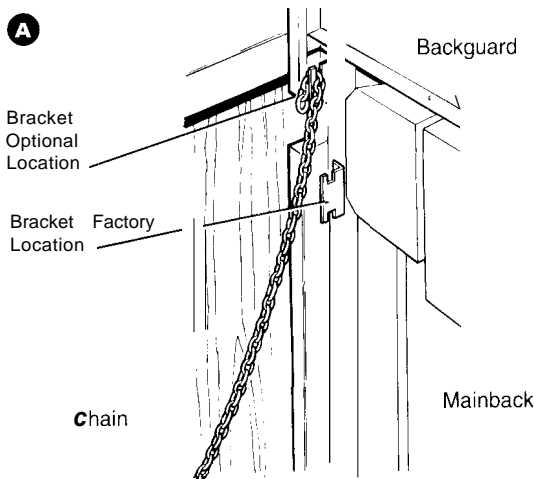

2. Fasten one end of the stability chain to the floor or wall with the long screw and washer supplied. See Fig. B. Make certain the screw is going into the wall plate at the base of the wall or one of the studs in the base of the wall. See Fig. C. Whether you attach the chain to the wall or floor, be certain that the screw is in at least 3/4 inch thickness of wood other than baseboard and that there are no electrical wires or plumbing in the area which the screw could penetrate. Attach the stability chain in a location which will allow the chain to be in line with the bracket side to aide as much as possible when attached to the unit. Test to see if the chain is securely fastened by tugging on the chain.

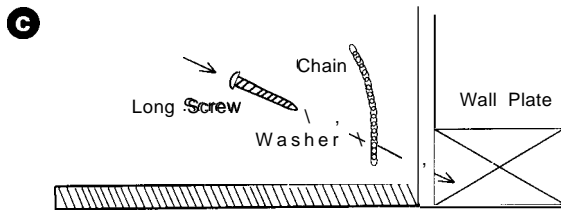
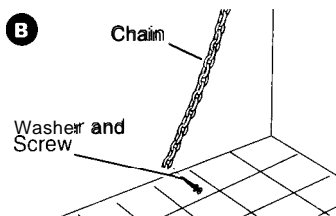

- Temporarily attach the loose end of the chain to the rear of the countertop with the tape from the packaging. See Fig. D.
- Place the range in the counter cutout leaving just enough room between the back of the range and the wall to reach the stability bracket.
- Hook the loose end of the chain onto the bracket by slipping the nearest link of the chain into the slot in the bracket. See Fig. A and make sure the chain is pulled as tight as possible and that there is no excess slack in the chain after the chain is attached to the bracket.

A CAUTION: Excessive slack in the chain could allow the range to tip over.

- Slide the range all the way back into the counter. Once the range is pushed back in place, there will be a small amount of slack in the chain. This is normal.

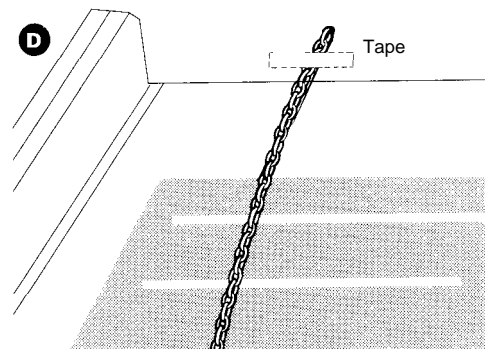

NOTE:

- If attaching to masonry, you can buy suitable screws and anchors at hardware stores. Use a masonry drill to drill the required holes.
- If range is removed for cleaning or any other reason, make sure chain is reattached.

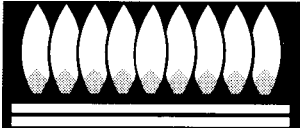
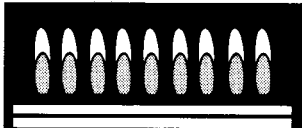
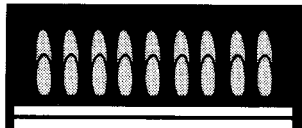

QUESTIONS? USE THIS PROBLEM SOLVER

PROBLEM	POSSIBLE CAUSE
TOP BURNERS DO NOT LIGHT OR DO NOT BURN EVENLY	<ul style="list-style-type: none"> • Pilots are not lit. Make sure electrical plug is plugged into a live power outlet. • Burner holes on the side or around the top of burner may be clogged. Remove burners and clean them with a small sewing needle or small safety pin. Make sure you do not enlarge the holes. • Burners may not be fitted correctly onto the mounting brackets. Remove and reinstall them properly.
BURNERS HAVE YELLOW OR YELLOW-TIPPED FLAMES	<div style="display: flex; justify-content: space-around; align-items: center;">    </div> <p>(A) Yellow flames— Call for service .</p> <p>(B) Yellow tips on inner cones—Normal for LP gas</p> <p>(C) Soft blue flames— Normal for natural gas</p> <ul style="list-style-type: none"> • If burner flames look like (A), call for service. Normal burner flames should look like (B) or (C), depending on the type of gas you use. • With LP gas, some yellow tipping on inner cones is normal.
BURNER FLAMES VERY LARGE OR YELLOW	<ul style="list-style-type: none"> • If range is connected to LP gas, check all steps in the Installation Instructions.
FOOD DOES NOT BROIL PROPERLY	<ul style="list-style-type: none"> • Oven controls not properly set. See the Broiling section. • Door not closed. • Improper shelf position being used. See the Broiling section. • Food is being cooked on a hot pan. • Cookware is not suited for broiling. • Aluminum foil used on the broiler pan rack has not been fitted properly and slit as recommended. • Oven bottom not securely seated in position.
FOOD DOES NOT ROAST OR BAKE PROPERLY	<ul style="list-style-type: none"> • Oven control not properly set. See the Baking or Roasting section. • Shelf position is not correct. • Incorrect cookware or cookware of improper size is being used. • Oven thermostat needs adjustment. See the Adjust the Oven Thermostat— <i>Do It Yourself</i> section. • Clock not set correctly. • Aluminum foil used improperly in the oven. • Oven bottom not securely seated in position.
CLOCK DOES NOT WORK	<ul style="list-style-type: none"> • Range electrical plug must be securely seated in a live power outlet. Check for blown fuse or tripped circuit breaker.
OVEN TEMPERATURE TOO HOT OR TOO COLD	<ul style="list-style-type: none"> • Oven thermostat needs adjustment. See the Adjust the Oven Thermostat— <i>Do It Yourself</i> section.
OVEN LIGHT DOES NOT COME ON	<ul style="list-style-type: none"> • Bulb may be loose or burned out. • Electrical plug must be plugged into a live power outlet. • Switch operating oven light is broken. Call for service.
STRONG ODOR	<ul style="list-style-type: none"> • An odor from the insulation around the inside of the oven is normal for the first few times oven is used. This is temporary. • Improper air/gas ratio in oven. Call for service.
“BURNING” OR “OILY” ODOR EMITTING FROM OVEN WHEN TURNED ON	<ul style="list-style-type: none"> • This is normal in a new oven and will disappear in time.

If you need more help... call, toll free: GE Answer Center,[®] S00.626.2000, consumer information service

We'll Be There

With the purchase of your new GE appliance, receive the assurance that if you ever need information or assistance from GE, we'll be there. All you have to do is call—toll-free!

GE Answer Center[®] **800.626.2000**

Whatever your question about any GE major appliance, GE Answer Center[®] information service is available to help. Your call and your question—will be answered promptly and courteously. And you can call any time. GE Answer Center[®] service is open 24 hours a day, 7 days a week.

In-Home Repair Service **800-GE-CARES (800-432-2737)**

A GE consumer service professional will provide expert repair service, scheduled at a time that's convenient for you. Many GE Consumer Service company-operated locations offer you service today or tomorrow, or at your convenience (7:00 a.m. to 7:00 p.m. weekdays, 9:00 a.m. to 2:00 p.m. Saturdays). Our factory-trained technicians know your appliance inside and out—so most repairs can be handled in just one visit.

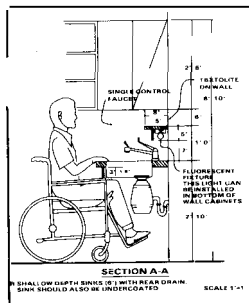

For Customers With Special Needs... **800.626.2000**

Upon request, GE will provide Braille controls for a variety of GE appliances, and a brochure to assist in planning a barrier-free kitchen for persons with limited mobility. To obtain these items, free of charge, call 800.626.2000.

Consumers with impaired hearing or speech who have access to a TDD or a conventional teletypewriter may call 800-TDD-GEA[®] (800-833-4322) to request information or service.

Service Contracts **800-626-2224**

You can have the secure feeling that GE Consumer Service will still be there after your warranty expires. purchase a GE contract while your warranty is still in effect and you'll receive a substantial discount. With a multiple-year contract, you're assured of future service at today's prices.

Parts and Accessories **800-626-2002**

Individuals qualified to service their own appliances can have needed parts or accessories sent directly to home. The GE parts system provides access to over 10,000 parts, and all GE Genuine Renewal Parts are fully warranted. VISA, MasterCard and Discover cards are accepted.

User maintenance instructions contained in this guide cover procedures intended to be performed by any user. Other servicing generally should be referred to qualified service personnel. Caution must be exercised, since improper servicing may cause unsafe operation.

**YOUR GE GAS RANGE
WARRANTY**

Staple sales slip or cancelled check here. Proof of original purchase date is needed to obtain service under warranty.

WHAT IS COVERED

FULL ONE-YEAR WARRANTY

For one year from date of original purchase, we will provide, free of charge, parts and service labor in your home to repair or replace **any part of the range** that fails because of a manufacturing defect.

This warranty is extended to the original purchaser and any succeeding owner for products purchased for ordinary home use in the 48 mainland states, Hawaii and Washington, D.C. In Alaska the warranty is the same except that it is LIMITED because you must pay to ship the product to the service shop or for the service technician's travel costs to your home.

All warranty service will be provided by our Factory Service Centers or by our authorized Customer Care[®] servicers during normal working hours.

Should your appliance need service, during warranty period or beyond, call 800-GE-CARES (800-432-2737).

WHAT IS NOT COVERED

- Service trips to your home to teach you how to use the product.

Read your Use and Care material.

If you then have any questions about operating the product, please contact your dealer or our Consumer Affairs office at the address below, or call, toll free:

GE Answer Center[®]
800.626.2000
consumer information service

- Improper installation

If you have an installation problem, contact your dealer or installer. You are responsible for providing adequate electrical, gas, exhausting and other connecting facilities as described in the Installation Instructions provided with the product.

- Replacement of house fuses or resetting of circuit breakers.
- Failure of the product if it is used for other than its intended purpose or used commercially.
- Damage to product caused by accident, fire, floods or acts of God.

WARRANTOR IS NOT RESPONSIBLE FOR CONSEQUENTIAL DAMAGES.

Some states do not allow the exclusion or limitation of incidental or consequential damages, so the above limitation or exclusion may not apply to you. This warranty gives you specific legal rights, and you may also have other rights which vary from state to state. To know what your legal rights are in your state, consult your local or state consumer affairs office or your state's Attorney General.

Warrantor: General Electric Company

**If further help is needed concerning this warranty, write:
Manager—Consumer Affairs, GE Appliances, Louisville, KY 40225**



Recycled Paper

Part No. 164 D2966P118

Pub No. 49-8597

295 CG

JGSC12

Printed in LaFayette, GA

Free Manuals Download Website

<http://myh66.com>

<http://usermanuals.us>

<http://www.somanuals.com>

<http://www.4manuals.cc>

<http://www.manual-lib.com>

<http://www.404manual.com>

<http://www.luxmanual.com>

<http://aubethermostatmanual.com>

Golf course search by state

<http://golfingnear.com>

Email search by domain

<http://emailbydomain.com>

Auto manuals search

<http://auto.somanuals.com>

TV manuals search

<http://tv.somanuals.com>