



GE Appliances

Self-Cleaning Halogen/Radiant  
**+ Ranges**



**Owner's Manual**

JBP90

JBP95

GE Answer Center® 800.626.2000

Part No. 164D3333P033 Pub. No. 49-8779

Download from [www.Somanuals.com](http://www.Somanuals.com). All Manuals Search And Download.

# Congratulations! You Are Now Part of the GE Family.

---

Welcome to the GE family. We're proud of our quality products and we are committed to providing dependable service. You'll see it in this easy-to-use Owner's Manual and you'll hear it in the friendly voices of our customer service department.

Best of all, you'll experience these values each time you use your range. That's important, because your new range will be part of your family for many years. And we hope you will be part of ours for a long time to come.

We thank you for buying GE. We appreciate your purchase and hope you will continue to rely on us whenever you need quality appliances for your home.

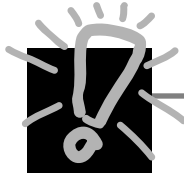

---

## **Important!**

***Staple sales slip or cancelled check here.***

*Proof of the original purchase date is needed to obtain service under the warranty.*



---

***Write the model and serial numbers here.***

#

---

#

*You can find them on a label behind the range door or behind the storage drawer.*

# GE & You, A Service Partnership.

Ask any GE appliance owner and they will tell you we stand behind our products with unmatched quality service. However, did you know that most questions result from simple problems that you can easily fix yourself in just a few minutes? This Owner's Manual can tell you how.



## Read this Manual

Inside you will find many helpful hints on how to use and maintain your range properly. Just a little preventive care on your part can save you a great deal of time and money over the life of your range.



## Review the Section on Troubleshooting Tips

You'll find many answers to common problems here. If you review our chart of Troubleshooting Tips first, you may not need to call for service at all.



## If You Need Service

If you do need service, you can relax knowing help is only a phone call away. A list of toll-free customer service numbers is included in the back section. Or you can always call the GE Answer Center® at 800.626.2000, 24 hours a day, 7 days a week.

### Safety Information

Anti-Tip Device . . . . .	4
Safety Precautions . . . . .	5-7
Oven . . . . .	8, 9
Radiant Surface Units . . . . .	10-12

Safety Information

### Operating Instructions

Using the Surface Units . . .	13, 14
Using the Oven . . . . .	16-29
Using the Clock and Timer . . .	21
Timed Baking and Roasting . . .	22, 23
Oven Thermostat . . . . .	33
Care and Cleaning . . . . .	37-43

Operating Instructions

### Installation Instructions

Before You Begin . . . . .	44
Prepare the Opening . . . . .	45
Flooring . . . . .	46
Electrical Connection . . . . .	46-51
Anti-Tip Bracket . . . . .	52
Leveling . . . . .	52

Installation Instructions

### Troubleshooting Tips

Before You	
Call For Service . . . . .	53-58

Troubleshooting Tips

### Customer Service

Warranty . . . . .	59
Service Telephone Numbers . . . . .	Back Cover

Customer Service

# IMPORTANT SAFETY INFORMATION. READ ALL INSTRUCTIONS BEFORE USING.

## **!** WARNING!

For your safety, the information in this manual must be followed to minimize the risk of fire or explosion, electric shock, or to prevent property damage, personal injury, or loss of life.



## **!** WARNING ANTI-TIP DEVICE

**All ranges can tip and injury could result.**

To prevent accidental tipping of the range, attach it to the wall and floor by installing the Anti-Tip device supplied.



To check if the device is installed and engaged properly, remove the kick panel or storage drawer and inspect the rear leveling leg. Make sure it fits securely into the slot.



If you pull the range out from the wall for any reason, make sure the device is properly engaged when you push the range back against the wall. If it is not, there is a possible risk of the range tipping over and causing injury if you or a child stand, sit or lean on an open door.

Please refer to the Anti-Tip device information in this manual. Failure to take this precaution could result in tipping of the range and injury.



## IMPORTANT SAFETY NOTICE

The California Safe Drinking Water and Toxic Enforcement Act requires the Governor of California to publish a list of substances known to the state to cause birth defects or other reproductive harm, and requires businesses to warn customers of potential exposure to such substances.

The fiberglass insulation in self-clean ovens gives off a very small amount of carbon monoxide during the cleaning cycle. Exposure can be minimized by venting with an open window or using a ventilation fan or hood.

Fluorescent light bulbs contain mercury. If your model has a surface light, you must recycle the fluorescent light bulb according to local, state and federal codes.

*Use this appliance only for its intended purpose as described in this Owner's Manual.*



## SAFETY PRECAUTIONS

*When using electrical appliances, basic safety precautions should be followed, including the following:*

- Be sure your appliance is properly installed and grounded by a qualified technician in accordance with the provided installation instructions.
- Do not attempt to repair or replace any part of your range unless it is specifically recommended in this manual. All other servicing should be referred to a qualified technician.
- Before performing any service, disconnect the range power supply at the household distribution panel by removing the fuse or switching off the circuit breaker.
- Do not leave children alone—children should not be left alone or unattended in an area where an appliance is in use. They should never be allowed to sit or stand on any part of the appliance.
- Do not allow anyone to climb, stand or hang on the door, storage drawer or cooktop. They could damage the range and even tip it over, causing severe personal injury.
- Do not store flammable materials in an oven or near the cooktop.
- **CAUTION:** Items of interest to children should not be stored in cabinets above a range or on the backsplash of a range—children climbing on the range to reach items could be seriously injured.
- Never wear loose-fitting or hanging garments while using the appliance. Be careful when reaching for items stored over the range. Flammable material could be ignited if brought in contact with hot surface units or heating elements and may cause severe burns.

# IMPORTANT SAFETY INFORMATION. READ ALL INSTRUCTIONS BEFORE USING.



## **⚠ WARNING!** SAFETY PRECAUTIONS

- Use only dry pot holders—moist or damp pot holders on hot surfaces may result in burns from steam. Do not let pot holders touch hot surface units or heating elements. Do not use a towel or other bulky cloth.
  - For your safety, never use your appliance for warming or heating the room.
  - Do not store or use combustible materials, gasoline or other flammable vapors and liquids in the vicinity of this or any other appliance.
  - Keep the hood and grease filters clean to maintain good venting and to avoid grease fires.
  - Do not let cooking grease or other flammable materials accumulate in or near the range.
  - Do not use water on grease fires. Never pick up a flaming pan. Turn the controls off. Smother a flaming pan on a surface unit by covering the pan completely with a well-fitting lid, cookie sheet or flat tray. Use a multi-purpose dry chemical or foam-type fire extinguisher.
- Flaming grease outside a pan can be put out by covering it with baking soda or, if available, by using a multi-purpose dry chemical or foam-type fire extinguisher. Flame in the oven can be smothered completely by closing the oven door and turning the oven off or by using a multi-purpose dry chemical or foam-type fire extinguisher.

- Do not touch the surface units, the heating elements or the interior surface of the oven. These surfaces may be hot enough to burn even though they are dark in color. During and after use, do not touch, or let clothing or other flammable materials contact, the surface units, areas nearby the surface units or any interior area of the oven; allow sufficient time for cooling first.

Potentially hot surfaces include the cooktop, areas facing the cooktop, oven vent opening, surfaces near the opening, crevices around the oven door and metal trim parts above the door.

**REMEMBER :** The inside surface of the oven may be hot when the door is opened.



## WHEN COOKING PORK . . .

*When cooking pork, follow the directions exactly and always cook the meat to an internal temperature of at least 170°F. This assures that, in the remote possibility that trichina may be present in the meat, it will be killed and the meat will be safe to eat.*

# **IMPORTANT SAFETY INFORMATION. READ ALL INSTRUCTIONS BEFORE USING.**

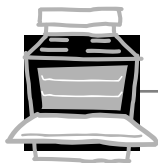

## **⚠ WARNING!** *OVEN*

- Stand away from the range when opening the oven door. Hot air or steam which escapes can cause burns to hands, face and/or eyes.
- Do not heat unopened food containers. Pressure could build up and the container could burst, causing an injury.
- Keep the oven vent unobstructed.
- Keep the oven free from grease buildup.
- Place the oven shelf in the desired position while the oven is cool. If shelves must be handled when hot, do not let pot holder contact the heating elements.
- Pulling out the shelf to the stop-lock is a convenience in lifting heavy foods. It is also a precaution against burns from touching hot surfaces of the door or oven walls.
- When using cooking or roasting bags in the oven, follow the manufacturer's directions.
- Do not use the oven to dry newspapers. If overheated, they can catch on fire.
- Do not use the oven for a storage area. Items stored in an oven can ignite.
- Do not leave paper products, cooking utensils or food in the oven when not in use.



## SELF-CLEANING OVEN

- Do not clean the door gasket. The door gasket is essential for a good seal. Care should be taken not to rub, damage or move the gasket.
- Clean only parts listed in this Owner's Manual.
- Do not use oven cleaners. No commercial oven cleaner or oven liner protective coating of any kind should be used in or around any part of the oven. Residue from oven cleaners will damage the inside of the oven when the self-clean cycle is used.
- Before self-cleaning the oven, remove the broiler pan, grid and other cookware.
- Be sure to wipe up excess spillage before starting the self-cleaning operation.
- If the self-cleaning mode malfunctions, turn the oven off and disconnect the power supply. Have it serviced by a qualified technician.

# IMPORTANT SAFETY INFORMATION. READ ALL INSTRUCTIONS BEFORE USING.



## **⚠ WARNING!**

### HALOGEN/RADIANT SURFACE UNITS

*Use proper pan size—select cookware having flat bottoms large enough to cover the surface unit heating element. The use of undersized cookware will expose a portion of the surface unit to direct contact and may result in ignition of clothing. Proper relationship of cookware to surface unit will also improve efficiency.*

- Never leave the surface units unattended at high heat settings. Boilovers cause smoking and greasy spillovers that may catch on fire.
- Avoid scratching the glass cooktop. The cooktop can be scratched with items such as sharp instruments, rings or other jewelry and rivets on clothing.
- To minimize the possibility of burns, ignition of flammable materials and spillage, the handle of a container should be turned toward the center of the range without extending over nearby surface units.
- Do not operate the halogen/radiant surface units if the glass is broken. Spillovers or cleaning solution may penetrate a broken cooktop and create a risk of electrical shock. Contact a qualified technician immediately should your glass cooktop become broken.
- Never use the glass cooktop surface as a cutting board.
- Do not place or store items that can melt or catch fire on the glass cooktop, even when it is not being used.
- Be careful when placing spoons or other stirring utensils on glass cooktop surface when it is in use. They may become hot and could cause burns.

- Use little fat for effective shallow or deep fat frying. Filling the pan too full of fat can cause spillovers when food is added.
- If a combination of oils or fats will be used in frying, stir together before heating, or as fats melt slowly.
- Always heat fat slowly, and watch as it heats.
- Use a deep fat thermometer whenever possible to prevent overheating fat beyond the smoking point.
- Always turn the surface units off before removing cookware.
- When flaming foods are under the hood, turn the fan off. The fan, if operating, may spread the flame.
- Keep an eye on foods being fried at high or medium high heat settings.
- Foods for frying should be as dry as possible. Frost on frozen foods or moisture on fresh foods can cause hot fat to bubble up and over the sides of the pan.

## **IMPORTANT SAFETY INFORMATION. READ ALL INSTRUCTIONS BEFORE USING.**



### **⚠ WARNING!**

#### **HALOGEN/RADIANT SURFACE UNITS**

*Use care when touching the cooktop. The glass surface of the cooktop will retain heat after the controls have been turned off.*

- Clean the cooktop with caution. If a wet sponge or cloth is used to wipe spills on a hot surface unit, be careful to avoid steam burns. Some cleaners can produce noxious fumes if applied to a hot surface.
- When the cooktop is cool, use only the recommended cleaning cream to clean the cooktop.
- To avoid possible damage to the cooking surface, do not apply cleaning cream to the glass surface when it is hot.
- After cleaning, use a dry cloth or paper towel to remove all cleaning cream residue.
- Read and follow all instructions and warnings on the cleaning cream labels.

**NOTE:** We recommend that you avoid wiping any surface unit areas until they have cooled and the indicator light has gone off. Sugar spills are the exception to this. Please see *Cleaning the glass cooktop* section.



### **REMEMBER...**

*Your continued health and safety are important to us. Please read and follow this Safety Information carefully. We want you to remain a happy and healthy part of our GE family.*

### **SAVE THESE INSTRUCTIONS**

## Using the surface units.

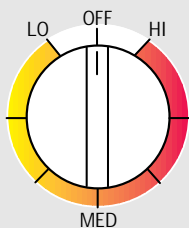

Be sure you turn the control knob to **OFF** when you finish cooking.

### How to Set

Push the knob in and turn in either direction to the setting you want.

At both **OFF** and **HI** the control **clicks** into position. You may hear slight **clicking** sounds during cooking, indicating the control is keeping the power level you set.

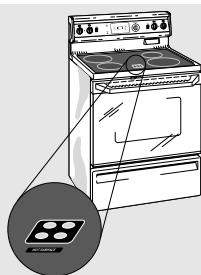

### Indicator Lights

A **HOT SURFACE** indicator light will glow when any halogen/radiant element is turned on, and will remain on until the surface is cool enough to touch.

A surface unit **ON** indicator light will glow when **any** surface unit is on.

**NOTE:** The surface unit **ON** indicator light may glow between the surface control settings of **LO** and **OFF**, but there is no power to the surface units.

### About the radiant surface units...

The radiant cooktop features heating units beneath a smooth glass surface.

**NOTE:** A slight odor is normal when a new cooktop is used for the first time. It is caused by the heating of new parts and insulating materials and will disappear in a short time.

The surface unit will cycle on and off to maintain your selected control setting.

It is safe to place hot cookware from the oven or surface on the glass surface when the surface is cool.

Even after the surface units are turned off, the glass cooktop retains enough heat to continue cooking. To avoid over-cooking, remove pans from the surface units when the food is cooked. Avoid placing anything on the surface unit until it has cooled completely.

- Water stains (mineral deposits) are removable using the cleaning cream or full strength white vinegar.
- Use of window cleaner may leave an iridescent film on the cooktop. The cleaning cream will remove this discoloration.
- Don't store heavy items above the cooktop. If they drop onto the cooktop, they can cause damage.
- Do not use the surface as a cutting board.



Never cook directly on the glass.  
Always use cookware.



Always place the pan in the center of the surface unit you are cooking on.

## Using the surface units

### Differences Between Halogen and Radiant Units

Halogen units have radiant coils in the center that do not glow as brightly as the outer halogen coils.

Some cooktops have both radiant and halogen surface units. This is how they differ.

- Halogen units are much brighter than the radiant units. Radiant units have a dull red glow.
- Halogen units hum louder than radiant units when they are first turned on.
- Halogen and radiant units cycle on and off frequently. This is normal. You will notice the cycling more on the halogen units because of their brightness.
- Halogen units click when they cycle on and off. Radiant units do not. This is due to the different switches used on halogen units.
- Radiant coils take about 10 seconds longer to glow than halogen units.

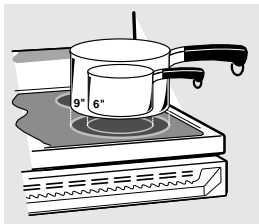

The right front surface unit has 2 cooking sizes to select from so you can match the size of the unit to the size of the cookware you are using.

### Dual Surface Unit Switch

To use the small (6 inch) surface unit, push in the left portion of the **COIL SIZE** switch next to the control knob.

To use the large (9 inch) surface unit, push in the right portion of the **COIL SIZE** switch.

### Temperature Limiter

Every halogen and radiant surface unit has a temperature limiter.

The temperature limiter protects the glass cooktop from getting too hot.

The temperature limiter may cycle the units off for a time if:

- The pan boils dry.
- The pan bottom is not flat.
- The pan is off center.
- There is no pan on the unit.

## Selecting types of cookware.

The following information will help you choose cookware which will give good performance.



Do not slide cookware across the cooktop because it can scratch the glass—the glass is scratch resistant, not scratch proof.

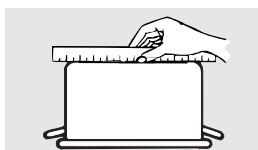

Check pans for flat bottoms by using a straight edge.

### Stainless Steel:

*recommended*

### Aluminum:

*heavy weight recommended*

Good conductivity. Aluminum residues sometimes appear as scratches on the cooktop, but can be removed if cleaned immediately. Because of its low melting point, thin weight aluminum should not be used.

### Copper Bottom:

*recommended*

Copper may leave residues which can appear as scratches. The residues can be removed, as long as the cooktop is cleaned immediately. However, do not let these pots boil dry. Overheated metal can bond to glass cooktops. An overheated copper bottom pot will leave a residue that will permanently stain the cooktop if not removed immediately.

### Porcelain Enamel Covered Cast Iron:

*recommended*

As long as the cookware is covered completely with porcelain enamel, this cookware is recommended. Caution is recommended for cast iron cookware that is not completely covered with smooth porcelain enamel, as it may scratch the glass ceramic cooktop.

### Glass-ceramic:

*usable, but not recommended*

Poor performance. May scratch the surface.

### Stoneware:

*usable, but not recommended*

Poor performance. May scratch the surface.

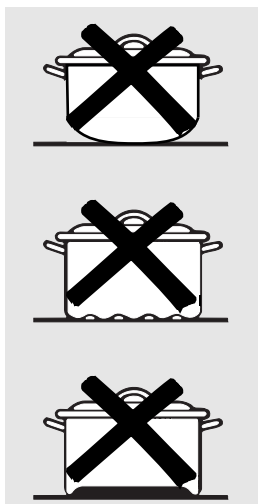



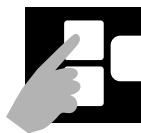
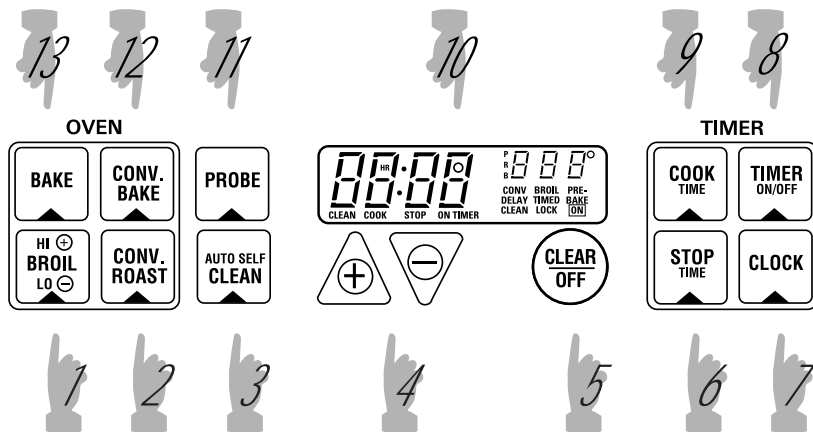

Pans with rounded, curved, ridged or warped bottoms are not recommended.

## Using the oven controls.

Throughout this manual, features and appearance may vary from your model.





### Clock and Timer Features

-  **STOP TIME**  
Press this pad and the + or - pad to delay the starting of your oven up to 9 hours and 55 minutes.
-  **CLOCK**  
Press this pad before setting the clock.
-  **TIMER ON/OFF**  
Press this pad to select the timer feature.
-  **COOK TIME**  
Press this pad and then press the + or - pad to set the amount of time you want your food to cook. The oven will shut off when the Cook Time has run out.

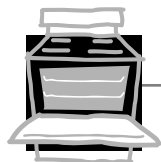









## Oven Control Settings

- 
**1 BROIL HI/LO Pad**  
 Press this pad to select the broil function.
- 
**2 CONV. ROAST Pad**  
 Press this pad to select roasting with the convection function.
- 
**3 AUTO SELF CLEAN**  
 Press this pad to select the self-cleaning function. See the *Using the self-cleaning oven* section.

**NOTE:** Do not lock the oven door with the latch during cooking. The latch is used for self-cleaning only.

- 
**4 + and – Pads**  
 These pads allow you to set times up to 9 hours and 55 minutes. Short taps to these pads change the time or temperature by small amounts. Press and hold the pad to change the time or temperature by larger amounts.
- 
**5 CLEAR/OFF Pad**  
 Press this pad to cancel **ALL** oven operations except the clock and timer.
- 
**10 Display**  
 Shows the time of day, oven temperature, whether the oven is in the bake, broil or self-cleaning mode and the times set for the timer on automatic oven operations.

**If “F-and a number” flash in the display and the oven control signals, this indicates a function error code.** If the function error code appears during the self-cleaning function check the oven door latch—the latch handle may have been moved, even if only slightly, from the latched position. Make sure the handle is to the right as far as it will go. Press the **CLEAR/OFF** pad. Allow the oven to cool for one hour. If the function error code repeats, disconnect the power to the range and call for service.

- 
**11 PROBE Pad**  
 Press this pad when using the probe to cook food.
- 
**12 CONV. BAKE Pad**  
 Press this pad to select baking with the convection function.
- 
**13 BAKE Pad**  
 Press this pad to select the bake function.

## Using the oven.

To avoid possible burns, place the shelves in the desired position before you turn the oven on.

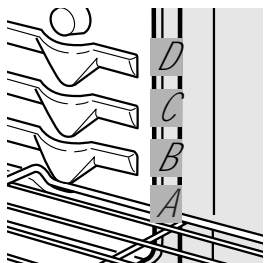

The oven has 4 shelf positions.

### Before you begin...

The shelves have stop-locks, so that when placed correctly on the supports, they will stop before coming completely out, and will not tilt.

When placing and removing cookware, pull the shelf out to the bump on the shelf support.

**To remove a shelf**, pull it toward you, tilt the front end up and pull it out.

**To replace**, place the end of the shelf (stop-locks) on the support, tilt up the front and push the shelf in.

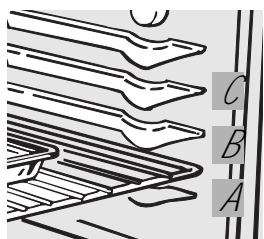

### How to Set the Oven for Baking or Roasting

- 1 Press the **BAKE** pad.
- 2 Press the **+** or **-** pad until the desired temperature is displayed.
- 3 Check food for doneness at minimum time on recipe. Cook longer if necessary.
- 4 Press the **CLEAR/OFF** pad when cooking is complete.

Type of Food	Shelf Position
Angel food cake and frozen pies (on cookie sheet)	A
Bundt or pound cakes	A or B
Biscuits, muffins, brownies, cookies, cupcakes, layer cakes, pies	B or C
Casseroles	B or C

## Preheating and Pan Placement

Preheat the oven if the recipe calls for it. To preheat, set the oven at the correct temperature. Preheating is necessary for good results when baking cakes, cookies, pastry and breads.

Baking results will be better if baking pans are centered as much as possible. Pans should not touch each other or the walls of the oven. If you need to use two shelves, stagger the pans so one is not directly above the other.

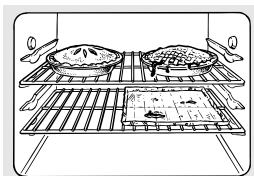

Aluminum foil may be used to catch a spillover.

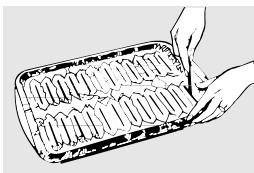

### Aluminum Foil

Never entirely cover a shelf with aluminum foil. This will disturb the heat circulation and result in poor baking.

A smaller sheet of foil may be used to catch a spillover by placing it on a lower shelf several inches below the food.

You can also use aluminum foil to line the broiler pan and broiler grid. However, you must mold the foil tightly to the grid and cut slits in it just like the grid.

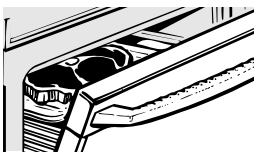

Leave the door open to the broil stop position. The door stays open by itself, yet the proper temperature is maintained in the oven.

### How to Set the Oven for Broiling

- 1 Place the meat or fish on the broiler grid in the broiler pan.
- 2 Follow suggested shelf positions in the *Broiling guide*.
- 3 Press the **BROIL HI/LO** pad.
- 4 Press the **+** pad once for **HI Broil**. To change to **LO Broil**, press the **-** pad once.
- 5 When broiling is finished, press the **CLEAR/OFF** pad.

## Broiling guide

Food	Quantity and/ or Thickness	Shelf Position	First Side Time (min.)	Second Side Time (min.)	Comments
<b>Bacon</b>	1/2 lb. (about 8 thin slices)	C	4½	4½	Arrange in single layer.
<b>Ground Beef</b> Well Done	1 lb. (4 patties) 1/2 to 3/4" thick	C	10	7	Space evenly. Up to 8 patties take about same time.
<b>Beef Steaks</b> Rare Medium Well Done	1" thick (1 to 1½ lbs.)	C C C	6 8 12	5 6 11	Steaks less than 1" thick cook through before browning. Pan frying is recommended.
Rare Medium Well Done	1½" thick (2 to 2½ lbs.)	C C C	10 15 25	7-8 14-16 20-25	Slash fat.
<b>Chicken</b>	1 whole (2 to 2½ lbs.), split lengthwise	A	35	10-15	Reduce time about 5 to 10 minutes per side for cut-up chicken. Brush each side with melted butter. Broil skin-side-down first.
<b>Lobster Tails</b>	2-4 (6 to 8 oz. each)	B	13-16	Do not turn over.	Cut through back of shell. Spread open. Brush with melted butter before broiling and after half of broiling time.
<b>Fish</b>	1-lb. fillets 1/4 to 1/2" thick	C	5	5	Handle and turn very carefully. Brush with lemon butter before and during cooking, if desired. Preheat broiler to increase browning.
<b>Ham Slices</b> (precooked)	1" thick	B	8	8	Increase time 5 to 10 minutes per side for 1½" thick or home cured ham.
<b>Pork Chops</b> Well Done	2 (1½" thick) 2 (1" thick), about 1 lb.	C B	10 13	10 13	Slash fat.
<b>Lamb Chops</b> Medium Well Done	2 (1" thick), about 10 to 12 oz.	C C	10 12	9 10	Slash fat.
Medium Well Done	2 (1½" thick), about 1 lb.	C B	14 17	12 12-14	

## Using the clock and timer.



Make sure the clock is set to the correct time of day.

The clock must be set for the automatic oven timing functions to work properly. The time of day cannot be changed during a timed baking or self-cleaning cycle.

### To Set the Clock:

- 1 Press the **CLOCK** pad.
- 2 Press the + and – pads.
- 3 Press the **CLOCK** pad to start.



The timer is a minute timer only.  
The timer does not control oven operations. The maximum setting on the timer is 9 hours and 55 minutes.

### To Set the Timer:

- 1 Press the **TIMER ON/OFF** pad.
- 2 Press the + and – pads until the amount of time you want shows in the display. The timer will start automatically within a few seconds of releasing the pad.

### To Reset the Timer:

If the display is still showing the time remaining, you may change it by pressing the the + and – pads until the time you want appears in the display.

If the remaining time is not in the display, recall the remaining time by pressing the **TIMER ON/OFF** pad and then pressing the the + and – pads until the new time you want shows in the display.

### To Cancel the Timer:

Press the **TIMER ON/OFF** pad once. To cancel the timer press the **TIMER ON/OFF** pad again and hold for 4 seconds.

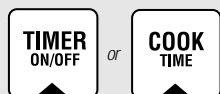

### End of Cycle Tones

Clear the tones by pressing the pad of the function you are using.

If you would like to remove the signal that beeps every 6 seconds, press and hold the **CLEAR/OFF** pad for 10 seconds.

To return the signal, press and hold the **CLEAR/OFF** pad for 10 seconds.

## Using the timed baking and roasting features.

Do not latch the oven door during timed cooking. The latch is used for self-cleaning only.

**NOTE:** Foods that spoil easily, such as milk, eggs, fish, stuffings, poultry and pork, should not be allowed to sit for more than 1 hour before or after cooking. Room temperature promotes the growth of harmful bacteria. Be sure that the oven light is off because heat from the bulb will speed harmful bacteria growth.

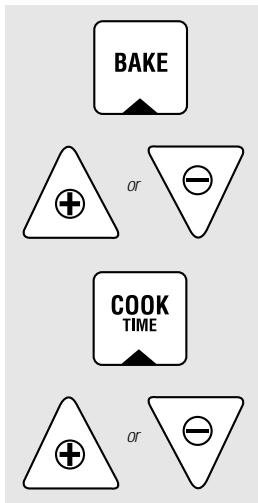

### How to Set an Immediate Start and Automatic Stop

Make sure the oven clock shows the correct time of day.

- 1 Press the **BAKE** pad.
- 2 Using the **+** or **-** pad, enter the desired temperature.
- 3 Press the **COOK TIME** pad.
- 4 Using the **+** or **-** pad, enter the desired baking time.

The word **ON** and **100°** will be displayed. The cook time will begin to count down. As the oven heats up, the display will show the changing temperature. When the oven reaches the temperature you set, 3 beeps will sound.

At the end of timed baking, the display will show **0HR:00 COOK TIME** and the oven will turn off. The end of cycle tone will sound.

Press the **CLEAR/OFF** pad to clear the display.

## How to Set a Delay Start and Automatic Stop

Make sure the oven clock shows the correct time of day.

- 1 Press the **BAKE** pad.
- 2 Using the **+** or **-** pad, enter the desired temperature.
- 3 Press the **COOK TIME** pad.
- 4 Using the **+** or **-** pad, enter the desired baking time.
- 5 Press the **STOP TIME** pad. The display prompts you to set the stop time you want. It also shows the earliest stop time you can set. Change the stop time by pressing the **+** or **-** pad until the desired stop time and **STOP TIME** appear in the display. The words **DELAY TIMED BAKE** appear in the display.

The oven will turn on automatically. The word **ON** and **100°** will be displayed. The cook time will begin to count down.

As the oven heats up, the display will show the changing temperature. The oven will cook for the programmed cooking time and shut off automatically.

At the end of timed baking, the display will show **0HR:00 COOK TIME** and the oven will turn off. The end of cycle tone will sound.

Press the **CLEAR/OFF** pad to clear the display.

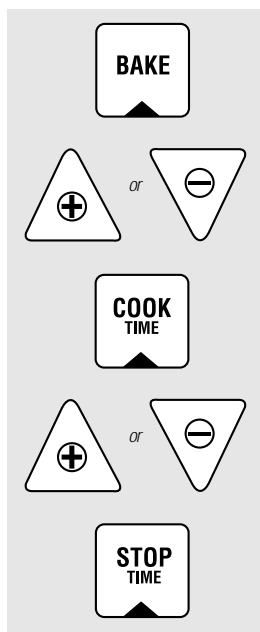

## Using the probe.

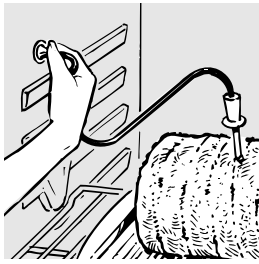

The temperature probe has a skewer-like probe at one end and a plug at the other end that goes into the outlet on the oven wall.

The probe is designed for use in high temperatures. Use of probes other than the one provided with this product may result in damage to the probe.

*Never leave your probe inside the oven during a self-cleaning cycle.*

Use the handles of the probe and plug when inserting and removing them from the meat and wall outlet.

- To avoid damaging your probe, do not use tongs to pull on the cable when removing it.
- To avoid breaking the probe, make sure food is completely defrosted before inserting.
- To prevent possible burns, do not unplug the probe from the outlet until the oven has cooled.

*Do not store the probe in the oven.*

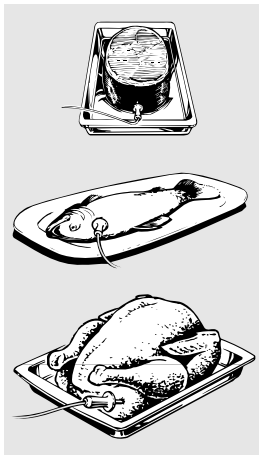

After preparing the meat and placing it on a trivet or on the broiler pan grid, follow these directions for proper probe placement.

- 1 Lay the probe on the outside of the meat along the top or side and mark with your finger where the edge of the meat comes to on the probe. The point should rest in the center of the thickest meaty part of the roast.
- 2 Insert the probe into the meat up to the point marked off with your finger. It should not touch the bone, fat or gristle.

*No more than 2 inches of the probe, not counting the handle, should be left exposed outside the meat.*

For roasts with no bone, insert the probe into the meatiest part of the roast. For bone-in ham or lamb, insert the probe into the center of the lowest large muscle or joint.

Insert the probe into the center of dishes such as meat loaf or casseroles. When cooking fish, insert the probe from just above the gill into the meatiest area, parallel to the backbone.

Insert the probe into the meatiest part of the inner thigh from below and parallel to the leg of a whole turkey.



For many foods, especially roasts and poultry, internal food temperature is the best test for doneness. The temperature probe takes the guesswork out of roasting by cooking foods to the exact doneness you want.

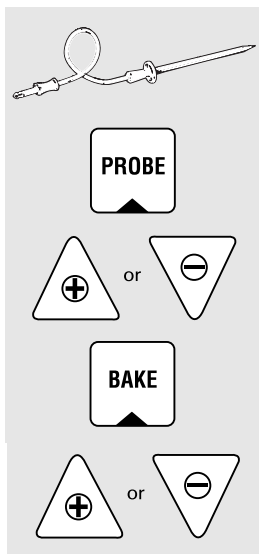

### How to set the oven for roasting when using the probe.

- 1 Insert the probe into the meat.
- 2 Plug the probe into the outlet on the oven wall. Make sure it's pushed all the way in. Close the oven door.
- 3 Press the **PROBE** pad.

The display will flash **PROBE** and the oven control will signal if the probe is inserted into the outlet, but the oven is not programmed for the probe.

- 4 Press the + or - pad until the desired internal probe temperature is displayed.
- 5 Press the **BAKE** pad.
- 6 Press the + or - pad. The last oven set temperature appears in the display. Continue pressing until the desired oven temperature is displayed.

When the oven starts to heat, the words **BAKE ON** and the roasting temperature you set will be in the display. After a few seconds, the words **LO PROBE** will replace the roasting temperature in the display.

After the internal temperature of the meat reaches 100°F., the changing internal temperature will be shown in the display.

- 7 When the internal temperature of the meat reaches the number you have set, the probe and the oven turn off and the oven control signals. To stop the signal, press the **CLEAR/OFF** pad. Use hot pads to remove the probe from the food. Do not use tongs to pull on it—they might damage it.

To change the oven temperature during the Roast cycle, press the **BAKE** pad and then the + or - pad to get the new temperature.

- If the probe is removed from the food before the final temperature is reached, a tone will sound and the display will flash until the probe is removed from the oven.
- You can use the timer even though you cannot use timed oven operations.

## Using the convection oven.

The convection oven fan shuts off when the oven door is opened. **DO NOT** leave the door open for long periods of time while using convection cooking or you may shorten the life of the convection heating element.

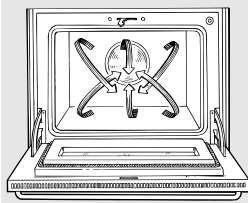

In a convection oven, a fan circulates hot air over, under and around the food. This circulating hot air is evenly distributed throughout the oven cavity. As a result, foods are evenly cooked and browned—often in less time with convection heat.

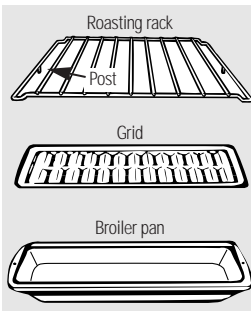

To help you understand the difference between convection bake and roast and traditional bake and roast, here are some general guidelines.

### Convection Bake

- Ideal for evenly browned baked foods cooked on all 3 shelves.
- Good for large quantities of baked foods.
- Good results with cookies, biscuits, muffins, brownies, cupcakes, cream puffs, sweet rolls, angel food cake and bread.

Heat comes from the heating element in the rear of the oven. The convection fan circulates the heated air evenly, over and around the food. Preheating is not necessary with foods having a bake time of over 15 minutes.

### Convection Roast

- Good for large tender cuts of meat, uncovered.

Heat comes from the top heating element. The convection fan circulates the heated air evenly over and around the food. Meat and poultry are browned on all sides as if they were cooked on a rotisserie. Using the roasting rack provided, heated air will be circulated over, under and around the food being roasted. The heated air seals in juices quickly for a moist and tender product while, at the same time, creating a rich golden brown exterior.

*Roasts or poultry should be cooked on the lowest shelf position (A) on a shelf.*

When you are convection roasting it is important that you use the broiler pan and grid and the special roasting rack for best convection roasting results. The pan is used to catch grease spills and the grid is used to prevent grease spatters. Place the meat on the special roasting rack. The rack holds the meat. The rack allows the heated air to circulate under the meat and increase browning on the underside of the meat or poultry.

- Place the shelf in the lowest shelf position (A).
- Place the grid on the broiler pan and put the roasting rack over them making sure the posts on the roasting rack fit into the holes in the broiler pan.

## Adapting Recipes...

You can use your favorite recipes in the convection oven. Recipe conversion is as easy as 1, 2, 3.

- 1 When roasting, reduce normal roasting time by 25%.
- 2 When baking, reduce baking temperature by 25°F.
- 3 No need to preheat when cooking longer than 15 minutes.

- For more information on adapting recipes, see the *Convection Cookbook*.
- Use pan size recommended.
- Some package instructions for frozen casseroles or main dishes have been developed using commercial convection ovens. For best results in this oven, preheat the oven and use the temperature on the package.

## Cookware for Convection Cooking

Before using your convection oven, check to see if your cookware leaves room for air circulation in the oven. If you are baking with several pans, leave space between them. Also, be sure the pans do not touch each other or the walls of the oven.

### Paper and Plastic

Heat-resistant paper and plastic containers that are recommended for use in regular ovens can be used in convection ovens. Plastic cookware that is heat-resistant to temperatures of 400°F. can also be used.

### Metal and Glass

Any type of cookware will work in your convection oven. However, metal pans heat the fastest and are recommended for convection baking.

- Darkened or matte-finished pans will bake faster than shiny pans.
- Glass or ceramic pans cook more slowly.

When baking cookies, you will get the best results if you use a flat cookie sheet instead of a pan with low sides.

For recipes like oven-baked chicken, use a pan with low sides. Hot air cannot circulate well around food in a pan with high sides.

## Using the convection oven.

Do not lock the oven door with the door latch during convection cooking. The latch is used for self-cleaning only.

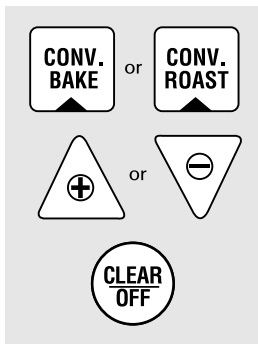

### How to Set the Oven for Convection Baking or Roasting

- 1 Press the **CONV. BAKE** or **CONV. ROAST** pad.
- 2 Press the **+** or **-** pad. The last oven set temperature appears in the display. Continue pressing until the desired temperature is displayed.

To change the oven temperature, press the **CONV. BAKE** or **CONV. ROAST** pad and then the **+** or **-** pad to get the new temperature.

When the oven starts to heat, the word **ON** and the changing temperature, starting at 100° F., will be displayed. When the oven reaches the temperature you set, 3 beeps will sound.

- 3 Press the **CLEAR/OFF** pad when finished.

#### NOTE:

- You will hear a fan while cooking with convection. The fan will stop when the door is opened but the heat will not turn off.
- You may hear the oven clicking during baking. This is normal.

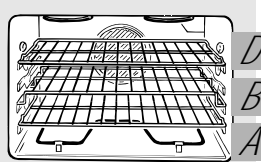

When convection baking with only 1 shelf, follow the shelf positions recommended in the Using the oven section.

### Multi-Shelf Baking

Because heated air is circulated evenly throughout the oven, foods can be baked with excellent results on 2 or 3 shelves at a time. Multi-shelf baking may increase cook times slightly for some foods but the overall result is time saved. Cookies, muffins, biscuits, and other quickbreads give very good results with multi-shelf baking.

When baking on 3 shelves, divide the oven into thirds by placing the offset shelf in the second (B) shelf position and the straight shelves in first (A) and fourth (D) shelf position.

For 2-shelf baking, place the straight shelves in the A and C positions.

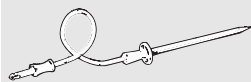

For best results when roasting large turkeys and roasts, we recommend using the probe included in the convection oven.



To change the oven temperature during the Convection Roast cycle, press the CONV. ROAST pad and then press the + or - pad to get the new desired temperature.

## How to Set the Oven for Convection Roasting when Using the Probe

Do not lock the oven door with the latch during convection roasting. The latch is used for self-cleaning only.

The display will flash **PROBE** and the oven control will signal if the probe is inserted into the outlet, but the oven is not programmed for the probe.

- 1 Place the shelf in the lowest position (A). Insert the probe into the meat.
- 2 Plug the probe into the outlet on the oven wall. Make sure it is pushed all the way in. Close the oven door.
- 3 Press the **PROBE** pad.
- 4 Press the + or - pad until the desired internal probe temperature is displayed.
- 5 Press the **CONV. ROAST** pad.
- 6 Press the + or - pad. The last oven set temperature appears in the display. Continue pressing until the desired oven temperature is displayed.

When the oven starts to heat, the words **CONV ON** and the roasting temperature you set will be in the display.

After a few seconds, the words **LO PROBE** will replace the roasting temperature in the display.

After the internal temperature of the meat reaches 100°F., the changing internal temperature will be shown in the display.

- 7 When the internal temperature of the meat reaches the number you have set, the probe and the oven turn off and the oven control signals. To stop the signal, press the **CLEAR/OFF** pad. Use hot pads to remove the probe from the food. Do not use tongs to pull on it—they might damage it.

**CAUTION:** To prevent possible burns, do not unplug the probe from the oven outlet until the oven has cooled. Do not store the probe in the oven.

### NOTE:

- If the probe is removed from the food before the final temperature is reached, a tone will sound and the display will flash until the probe is removed from the oven.
- You will hear a fan while cooking with this feature. The fan will stop when the door is opened but the heat will not turn off.
- You can use the timer even though you cannot use timed oven operations.

## Convection roasting guide

Meats			Minutes/Lb.	Oven Temp.	Internal Temp.	
Beef	Rib, Boneless Rib, Top Sirloin (3 to 5 lbs.)	Rare	20–24	325°F.	140°F.†	
		Medium	24–28	325°F.	160°F.	
		Well	28–32	325°F.	170°F.	
	Beef Tenderloin	Rare	10–14	325°F.	140°F.†	
		Medium	14–18	325°F.	160°F.	
	Pot Roast Chuck, Rump (2½ to 3 lbs.)		35–45	300°F.	170°F.	
Pork	Bone-in, Boneless (3 to 5 lbs.)		23–27	325°F.	170°F.	
		Chops	2 chops	30–35 total	325°F.	170°F.
		(1/2 to	4 chops	35–40 total	325°F.	170°F.
		1" thick)	6 chops	40–45 total	325°F.	170°F.
Ham	Canned, Butt, Shank (3 to 5 lbs. fully cooked)		14–18	325°F.	140°F.	
Lamb	Bone-in, Boneless (3 to 5 lbs.)	Medium	17–20	325°F.	160°F.	
		Well	20–24	325°F.	170°F.	
Seafood	Fish, whole (3 to 5 lbs.)		30–40 total	400°F.		
	Lobster Tails (6 to 8 oz. each)		20–25 total	350°F.		
Poultry	Whole Chicken (2½ to 3½ lbs.)		24–26	350°F.	180°–185°F.	
	Cornish Hens Unstuffed (1 to 1½ lbs.)		50–55 total	350°F.	180°–185°F.	
	Stuffed (1 to 1½ lbs.)		55–60 total	350°F.	180°–185°F.	
	Duckling (4 to 5 lbs.)		24–26	325°F.	180°–185°F.	
	Turkey, whole*					
Unstuffed (10 to 16 lbs.)	8–11		325°F.	180°–185°F.		
Unstuffed (18 to 24 lbs.)	7–10		325°F.	180°–185°F.		
Turkey Breast (4 to 6 lbs.)	16–19		325°F.	170°F.		

\* Stuffed birds generally require 30–45 minutes additional roasting time. Shield legs and breast with foil to prevent over-browning and drying of skin.

† The U.S. Department of Agriculture says "Rare beef is popular, but you should know that cooking it to only 140°F. means some food poisoning organisms may survive." (Source: Safe Food Book. Your Kitchen Guide. USDA Rev. June 1985.)

## Using the timed features for convection baking.

Do not lock the oven door with the latch during timed cooking. The latch is used for self-cleaning only.

**NOTE:** Foods that spoil easily, such as milk, eggs, fish, stuffings, poultry and pork, should not be allowed to sit for more than 1 hour before or after cooking. Room temperature promotes the growth of harmful bacteria. Be sure that the oven light is off because heat from the bulb will speed harmful bacteria growth.

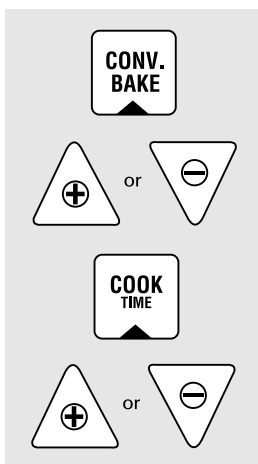

The oven will turn on immediately and cook for a selected length of time. At the end of the cooking time the oven will turn off automatically.

*Make sure the oven clock shows the correct time of day.*

- 1 Press the **CONV. BAKE** pad.
- 2 Press the **+** or **-** pad until the desired temperature is displayed.
- 3 Press the **COOK TIME** pad.
- 4 Press the **+** or **-** pad until the desired length of baking time appears in the display. The minimum Cook Time you can set is 10 minutes.

The words **TIMED CONV BAKE** and **COOK TIME** will be displayed along with the oven temperature that you set and the cook time that you entered. When the oven starts to heat, the word **ON** and the changing temperature, starting at 100° F., will be displayed. When the oven reaches the temperature you set, 3 beeps will sound. The oven will continue to cook for the programmed amount of time, then shut off automatically.

- 5 At the end of Timed Convection Bake the display will show **0HR:00 COOK TIME** and the oven will turn off. The end of cycle tone will sound. Press the **CLEAR/OFF** pad to clear the display if necessary.
- 6 Remove the food from the oven. Remember, foods that are left in the oven continue cooking after the controls are off.

**NOTE:** You will hear a fan while cooking with this feature. The fan will stop when the door is opened but the heat will not turn off.

## Using the timed features for convection baking.

Do not lock the oven door with the latch during timed cooking. The latch is used for self-cleaning only.

**NOTE:** Foods that spoil easily, such as milk, eggs, fish, stuffings, poultry and pork, should not be allowed to sit for more than 1 hour before or after cooking. Room temperature promotes the growth of harmful bacteria. Be sure that the oven light is off because heat from the bulb will speed harmful bacteria growth.

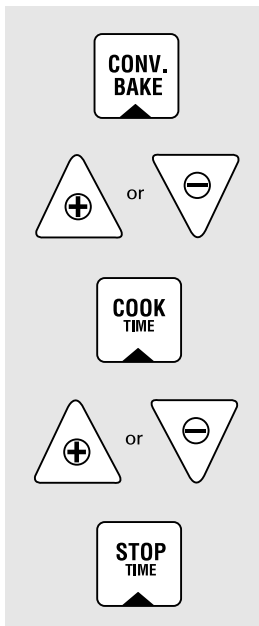

You can set the oven control to delay-start the oven, cook for a specific length of time and then turn off automatically.

- 1 Press the **CONV. BAKE** pad.
- 2 Press the **+** or **-** pad until the desired temperature is displayed.
- 3 Press the **COOK TIME** pad.
- 4 Press the **+** or **-** pad until the desired cooking time appears in the display.
- 5 Press the **STOP TIME** pad.

The control automatically sets the Stop Time by adding the Cook Time to the time of day.

- 6 Change the Stop Time by pressing the **+** or **-** pad until the desired Stop Time appears in the display. The words **DELAY TIMED CONV BAKE** and **STOP TIME** appear in the display.

The oven will turn on automatically. When the oven starts to heat, the word **ON** and the changing oven temperature, starting at 100° F., will be displayed. The oven will continue to cook for the programmed time and shut off automatically.

At the end of Timed Convection Bake, the display will show **0HR:00**, **COOK TIME** and the oven will turn off. The end of cycle tone will sound.

- 7 Press the **CLEAR/OFF** pad to clear the display if necessary. When baking is finished, remove the food from the oven. Remember, even though the oven shuts off automatically, foods continue cooking after the controls are off.

**NOTE:** You will hear a fan while cooking with this feature. The fan will stop when the door is opened but the heat will not turn off.



## Adjust the oven thermostat—Do it yourself!

You may find that your new oven cooks differently than the one it replaced. Use your new oven for a few weeks to become more familiar with it. If you still think your new oven is too hot or too cold, you can adjust the thermostat yourself.

Do not use inexpensive thermometers, such as those found in grocery stores, to check the temperature setting of your oven. These thermometers may vary 20–40 degrees.

**NOTE:** This adjustment will not affect the broiling or the self-cleaning temperatures. The adjustment will be retained in memory after a power failure.

### To Adjust the Thermostat

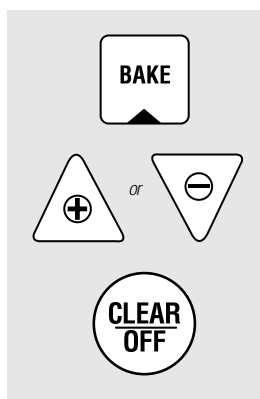

- 1 Press the **BAKE** pad.
- 2 Select an oven temperature between 500°F and 550°F.
- 3 Immediately, before **ON** appears, press and hold the **BAKE** pad for about 4 seconds. The time display will change to the oven adjustment display.
- 4 The oven temperature can be adjusted up to (+) 35°F. hotter or (-) 35°F. cooler. Use the + or - pad to select the desired change in the display.
- 5 When you have made the adjustment, press the **CLEAR/OFF** pad to go back to the time of day display. Use your oven as you would normally.

**NOTE:** The thermostat adjustment for Baking does not affect Convection Baking or Convection Roasting. To adjust these, press the **CONV. BAKE** or the **CONV. ROAST** pad instead of the **BAKE** pad when following the directions under To Adjust the Thermostat.

## Using the self-cleaning oven.

Never force the latch handle. Forcing the handle will damage the door lock mechanism.

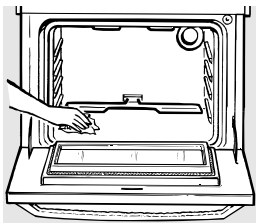

Wipe up heavy soil on the oven bottom.

### Before a Clean Cycle

The range must be completely cool in order to set the self-clean cycle.

We recommend venting with an open window or using a ventilation fan or hood during the first self-clean cycle.

Remove all cookware and any aluminum foil from the oven.

The oven shelves can be self-cleaned, but they will darken, lose their luster and become hard to slide.

Do not use abrasives or oven cleaners. Clean the top, sides and outside of the oven door with soap and water.

The enamel grid and broiler pan may be cleaned in the self-cleaning oven. However, to help prevent heavy smoke caused by self-cleaning the greasy soil in the pan, you must first clean off the excess grease.

Make sure the oven light bulb cover is in place and the oven light is off.

Never force the latch handle. Forcing the handle will damage the door lock mechanism.



### How to Set the Oven for Cleaning

- 1 Latch the door.
- 2 Press the **AUTO SELF CLEAN** pad.
- 3 Using the + or - pad, enter the desired clean time.

Clean cycle time is normally 3 hours. You can change the clean time to between 2 hours and 4 hours, depending on how dirty your oven is.

The self-clean cycle will automatically begin after **CLEAN** is displayed and the time for the clean cycle is set. The words **ON** and **LOCK** will appear in the display. It will not be possible to open the oven door until the temperature drops below the lock temperature and the **LOCK** light goes off.

When the **LOCK** light is off, slide the latch handle to the left as far as it will go and open the door.

- The word **door** will be displayed, the word **LOCK** will flash and the oven control will signal if you set the clean cycle and forget to close the oven door.
- To stop a clean cycle, press the **CLEAR/OFF** pad. When the **LOCK** light goes off and the oven has cooled below the locking temperature, open the door.

## Using the self-cleaning oven.

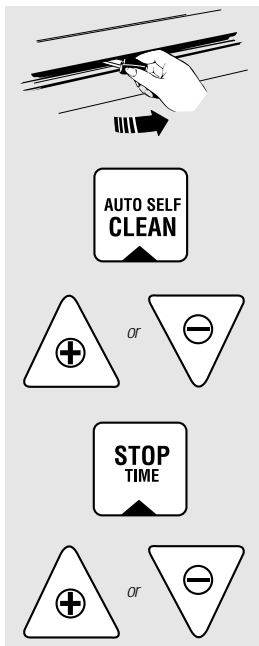

### How to Delay the Start of Cleaning

- 1 Latch the door.
- 2 Press the **AUTO SELF CLEAN** pad.
- 3 Using the + or - pad, enter the desired clean time.
- 4 Press the **STOP TIME** pad. The earliest stop time you can set will appear in the display.
- 5 Using the + or - pad, enter the desired stop time.

The self-clean cycle will automatically begin after **CLEAN** is displayed and the time for the clean cycle is reached. The words **ON** and **LOCK** will appear in the display. It will not be possible to open the oven door until the temperature drops below the lock temperature and the **LOCK** light goes off.

When the **LOCK** light is off, slide the latch handle to the left as far as it will go and open the door.

### After a Clean Cycle

You may notice some white ash in the oven. Wipe it up with a damp cloth after the oven cools.

*If white spots remain, remove them with a soap-filled steel wool pad and rinse thoroughly with a vinegar and water mixture.*

These deposits are usually a salt residue that cannot be removed by the clean cycle.

If the oven is not clean after one clean cycle, repeat the cycle.

- You cannot set the oven for cooking until the oven is cool enough for the door to be unlatched.
- While the oven is self-cleaning, you can press the **CLOCK** pad to display the time of day. To return to the clean countdown, press the **COOK TIME** pad.
- If the shelves become hard to slide, wipe the shelf supports with cooking oil.

## Care and cleaning of the range.



If your range is removed for cleaning, servicing or any reason, be sure the anti-tip device is re-engaged properly when the range is replaced. Failure to take this precaution could result in tipping of the range and cause injury.

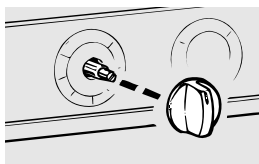

Pull the knob straight off the stem.

### Control Panel and Knobs

Clean up spatters with a damp cloth. Remove heavier soil with warm, soapy water.

*Do not use abrasives of any kind on the control panel.*

The control knobs may be removed for easier cleaning. To remove a knob, pull it straight off the stem. Wash the knobs in soap and water but do not soak.

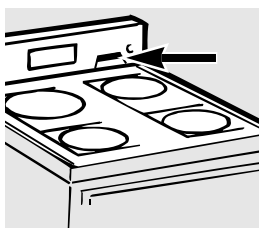

Oven vent location

### Oven Vent

The oven is vented through an opening at the rear of the cooktop.

*Never cover the opening with aluminum foil or any other material.*

### Painted Surfaces

Painted surfaces include the sides and the drawer front.

Clean these with soap and water or a vinegar and water solution.

Do not use commercial oven cleaners, cleaning powders, steel wool or harsh abrasives on any painted surface.

## Care and cleaning of the range.

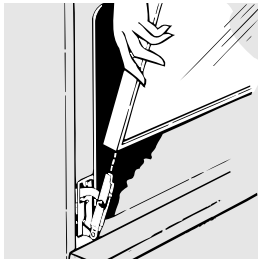

Lift the door straight up and off the hinges.

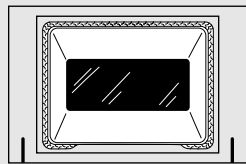

The gasket is designed with a gap at the bottom to allow for proper air circulation.

### Lift-Off Oven Door

The oven door is removable for cleaning.

*Do not lift the door by the handle.*

**To remove the door**, open it to the special stop position. Grasp firmly on each side and lift the door straight up and off the hinges.

*Do not place hands between the hinge and the oven door frame.*

**To replace the door**, make sure the hinges are in the special stop position. Position the slots in the bottom of the door squarely over the hinges and slowly lower it over both hinges.

### To clean the inside of the door:

- Because the area inside the gasket is cleaned during the self-clean cycle, you do not need to clean this by hand.
- The area outside the gasket and the front frame can be cleaned with a soap-filled scouring pad, hot water and detergent. Rinse well with a vinegar and water solution.

*Do not rub or clean the door gasket—it has an extremely low resistance to abrasion.*

- If you notice the gasket becoming worn, frayed or damaged in any way or if it has become displaced on the door, you should have it replaced.

### To clean the outside of the door:

- Use soap and water to thoroughly clean the top, sides and front of the oven door. Rinse well. You may also use a glass cleaner to clean the glass on the outside of the door. Do not let water drip into the vent openings.
- Spillage of marinades, fruit juices, tomato sauces and basting materials containing acids may cause discoloration and should be wiped up immediately. When surface is cool, clean and rinse.
- Do not use oven cleaners, cleaning powders or harsh abrasives on the outside of the door.

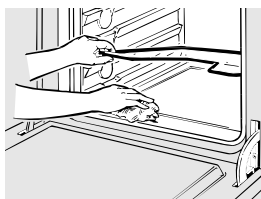

### Oven Heating Elements

Do not clean the bake element or the broil element.  
Any soil will burn off when the elements are heated.

To clean the oven floor, gently lift the bake element.  
Clean with warm soapy water.

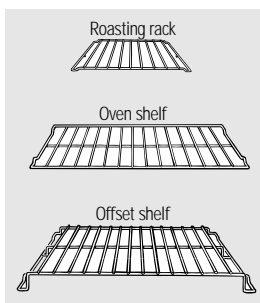

### Oven Shelves and Convection Roasting Rack

Clean the oven shelves (including the offset shelf) and the convection roasting rack with an abrasive cleanser or steel wool. After cleaning, rinse the shelves and rack with clean water and dry with a clean cloth.

**NOTE:** The oven shelves and convection roasting rack may be cleaned in the self-cleaning oven, however, the shelves will darken in color, lose their luster and become hard to slide if cleaned during the self-cleaning cycle. You can wipe the shelf supports with cooking oil after self-cleaning to make the shelves slide more easily.

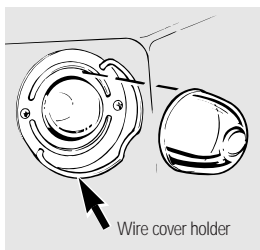

### Oven Light Replacement

**CAUTION:** Before replacing your oven light bulb, disconnect the electrical power to the range at the main fuse or circuit breaker panel.

Be sure to let the light cover and bulb cool completely.

**To remove the cover:**

- 1 Hold a hand under the cover so it doesn't fall when released. With fingers of the same hand, firmly push back the wire cover holder. Lift off the cover.

*Do not remove any screws to remove the cover.*

- 2 Replace bulb with a 40-watt household appliance bulb.

**To replace the cover:**

- 1 Place it into groove of the light receptacle. Pull wire forward to the center of the cover until it snaps into place.
- 2 Connect electrical power to the range.

## Care and cleaning of the range.

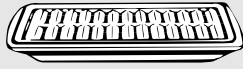

After broiling remove the broiler pan from the oven.

### Broiler Pan & Grid

After broiling, remove the broiler pan from the oven. Remove the grid from the pan. Carefully pour out the grease from the pan into a proper container.

Wash and rinse the broiler pan and grid in hot water with a soap-filled or plastic scouring pad.

If food has burned on, sprinkle the grid with detergent while hot and cover with wet paper towels or a dishcloth. Soaking the pan will remove burned-on foods.

The broiler pan may be cleaned with a commercial oven cleaner. If the grid is grey enamel, it can also be cleaned with an oven cleaner. If the grid is chrome, do not use an oven cleaner to clean it.

Both the broiler pan and grid can also be cleaned in the dishwasher.

*Do not store a soiled broiler pan and grid anywhere in the range.*

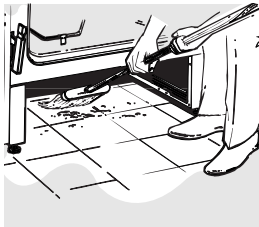

Clean under the range.

### How to Remove the Storage Drawer or Kick Panel to Clean Under the Range

*To remove the storage drawer:*

- 1 Pull the drawer out all the way.
- 2 Tilt up the front and remove it.

*To replace the storage drawer:*

- 1 Insert glides at the back of the drawer beyond the stop on range glides.
- 2 Lift the drawer if necessary to insert easily.
- 3 Let the front of the drawer down, then push in to close.

*To remove the kick panel,* pull it straight out at the bottom.

*To replace the panel,* first hook the top tabs on and then the bottom tabs.



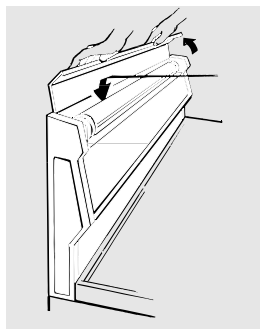

### Cooktop Surface Light

When changing a cooktop light, do not touch the metal at the ends of the light.

The cooktop light is easily replaced with a fluorescent tube of the same wattage. Before changing the light, pull the plug to the range or disconnect the power at the main fuse or circuit breaker panel.

#### To remove:

- 1 Lift the light cover by pulling the bottom edge toward you and then up.
- 2 Place fingers on top near each end of the light.
- 3 Roll the top of the light gently toward the front of the range and gently pull the light from the socket, making sure it does not hit the light cover.

#### To replace:

- 1 Place fingers on the top near each end of the light.
- 2 Press the light into the slots until it snaps into place.
- 3 Move light cover down and snap into place.

### Sure Grip Handle

The *sure grip* door handle is easy to keep clean.

Soil will easily wash off with soap and water or a non-abrasive all-purpose cleaner.

Avoid using heavy-duty all-purpose cleaners and detergents as they may contain chemicals which might harm the *sure grip* handle.

## Cleaning the glass cooktop.

Clean the glass surface with cleaning cream before you use the cooktop for the first time. Also, clean the glass surface after each use. This helps protect the top and makes clean-up easier.

**To clean the cooktop seal**, let a wet cloth rest on it for a few minutes, then wipe clean. Use a mild detergent if needed.

*Do not use a knife or any sharp object on the seal because it will cut or damage it.*

### Daily Cleaning

Use only a recommended cleaning cream, such as Cerama Brite or the Cooktop Cleaning Creme, on the glass cooktop.

To maintain and protect the surface of your new glass cooktop follow these steps.

Before you use the cooktop for the first time, clean it with cleaning cream. This helps protect the top and makes clean-up easier.

- Clean the surface with the cleaning cream after each use.
- Rub a few drops (less is better) of the cleaning cream onto soiled area using a damp paper towel. Buff with a dry paper towel until all soil and cream are removed.

### For heavy, burned-on soil:

- 1 Apply a few drops of the cleaning cream to the (cool) soiled area.
- 2 Using a damp paper towel, rub the cream into the burned-on area. As with any burned-on spill, this may require some effort.
- 3 Carefully scrape soil with razor scraper. Hold scraper at a 30° angle against the glass cooktop.
- 4 If any soil remains, repeat the steps listed above. For additional protection, after all soil has been removed, polish the entire surface with the cleaning cream.
- 5 Buff with a dry paper towel.

To order more cream and/or scrapers for cleaning your glass cooktop, please call our toll-free number:

**National Parts Center**  
800-626-2002

**Cleaner** ..... # WX10X300  
**Scraper** ..... # WX5X1614  
**Cream & scraper kit** ... # WB64X5027

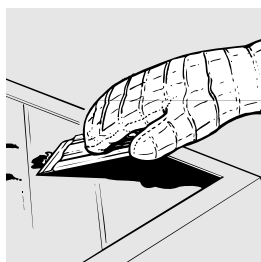

Using a razor scraper will not damage the surface if the 30° angle is maintained.

## Special Care

Be sure to use a new sharp razor scraper. Do not use a dull or nicked blade.

Sugary spillovers (such as jellies, fudge, candy syrups) or melted plastics can cause pitting of the surface of your cooktop (not covered by the warranty) unless the spill is removed while still hot. Special care should be taken when removing hot substances.

- 1 Turn off all surface units affected by the spillover. Remove hot pans.
- 2 Wearing an oven mitt, hold the razor scraper at a 30° angle to the cooktop. Scrape the hot spill to a cool area outside the surface unit.
- 3 With the spill in a cool area, use a dry paper towel to remove any excess. Any spillover remaining should be left until the surface of the cooktop has cooled. Do not continue to use the soiled surface unit until all of the spillover has been removed. Follow the steps under *Heavy Soil* to continue the cleaning process.

**NOTE:** If pots with a thin overlay of aluminum, copper or enamel are allowed to boil dry, the overlay may bond with the glass cooktop and leave a black discoloration. This should be removed immediately before heating again or the discoloration may be permanent.

## Installation of the range.

Read these instructions completely and carefully.



### Before You Begin

**IMPORTANT:** Save these instructions for the local electrical inspector's use.

**IMPORTANT: OBSERVE ALL GOVERNING CODES AND ORDINANCES.**

**NOTE TO INSTALLER:** Leave these instructions with the appliance after installation is completed.

**NOTE TO CONSUMER:** Keep this Owner's Manual and Installation Instructions for future use.

**NOTE:** This appliance must be properly grounded.



### Tools You Will Need

- Large blade screwdriver
- 1/4" hex head nutdriver
- Channel lock pliers or small ratchet wrench with 3/16" socket (for leveling range)



### Electrical Requirements

**CAUTION, FOR PERSONAL SAFETY: DO NOT USE AN EXTENSION CORD WITH THIS APPLIANCE.**

**REMOVE HOUSE FUSE OR OPEN CIRCUIT BREAKER BEFORE BEGINNING INSTALLATION.**

This appliance must be supplied with the proper voltage and frequency, and connected to an individual, properly grounded branch circuit, protected by a circuit breaker or time delay fuse, as noted on the rating plate.

*Wiring must conform to National Electric Codes.*

If the electric service provided does not meet the above specifications, have a licensed electrician install an approved outlet.

Because range terminals are not accessible after range is in position, flexible service conduit or cord must be used.

Read these instructions completely and carefully.

## Prepare the Opening

Allow  $1\frac{1}{2}$ " spacing from the range to adjacent vertical walls above cooktop surface.

Allow  $30$ " minimum clearance between surface units and bottom of unprotected wood or metal top cabinet, and  $15$ " minimum between countertop and adjacent cabinet bottom.

*EXCEPTION: Installation of a listed microwave oven or cooking appliance over the cooktop shall conform to the installation instructions packed with that appliance.*

If cabinet storage is installed, reduce risk by installing a range hood that projects horizontally a min. of  $5$ " beyond the bottom of the cabinets. Make sure the wall covering, countertops and cabinets around the range can withstand heat generated by the range, oven or cooktop up to  $200^{\circ}\text{F}$ .

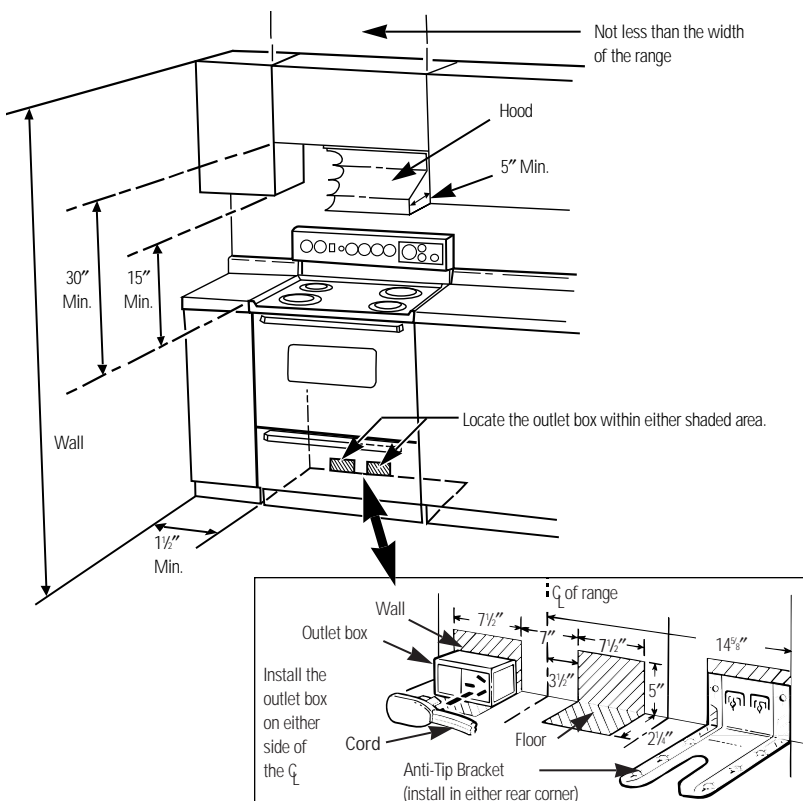

## Installation of the range.

*Read these instructions completely and carefully.*

### **Flooring Under the Range**

*Your range, like many other household items, is heavy and can settle into soft floor coverings such as cushioned vinyl or carpeting.*

When moving the range on this type of flooring, it should be installed on a 1/4" thick sheet of plywood (or similar material) as follows:

When the floor covering ends at the front of the range, the area that the range will rest on should be built up with plywood to the same level or higher than the floor covering. This will allow the range to be moved for cleaning or servicing.

### **Prepare for Electrical Connection**

*Effective January 1, 1996 the National Electric Code requires that new construction (not existing) utilize a 4-conductor connection to an electric range.*

*When installing an electric range in new construction follow Steps 3 and 5 for 4-wire connection.*

Use only a 3-conductor or a 4-conductor UL-listed range cord. These cords may be provided with ring terminals on wire and a strain relief device.

A range cord rated at 40 amps with 125/250 minimum volt range is required. A 50 amp range cord is not recommended but if used, it should be marked for use with nominal 1 3/8" diameter connection openings. Care should be taken to center the cable and strain relief within the knockout hole to keep the edge from damaging the cable.

**NOTE:** *A 4-conductor cord is to be used when the appliance is installed in a mobile home or when local codes do not permit grounding through the neutral. If conduit is being used, go to Step 6 or 7.*

### 3 Power Cord Strain Relief Installation

- a Remove the lower rear range wiring cover to expose the connector block and bracket.
- b Remove the knockout ring (1 $\frac{3}{8}$ "") located on bracket directly below the connector. To remove the knockout, use a pair of pliers to bend the knockout ring away from the bracket and twist until ring is removed.

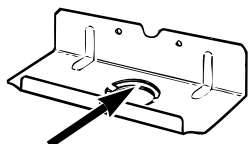

Knockout ring in bracket.

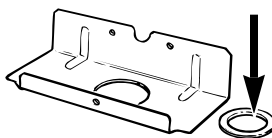

Knockout ring removed.

- c Assemble the strain relief in the hole. Insert the power cord through the strain relief and tighten. Allow enough slack to easily attach the cord terminals to the connector block. If tabs are present at the end of the winged strain relief, they can be removed for better fit.

**NOTE:** Do not install the power cord without a strain relief.

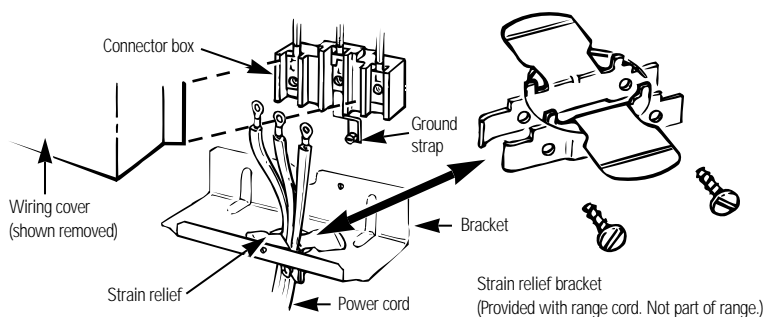

## Installation of the range.

Read these instructions completely and carefully.

### 4 3-Wire Power Cord Installation

**⚠ WARNING:** The neutral or ground wire of the power cord must be connected to the neutral terminal located in the center of the connector block. The power leads must be connected to the outside (brass colored) terminals.

Remove the 3 wire terminal screws from the connector block. Insert screws through each power cord terminal ring and into the connector block until the screws engage the nuts. Be certain that the center wire is connected to the center screw of the connector block. Tighten screws securely.

Do NOT remove ground strap connection.

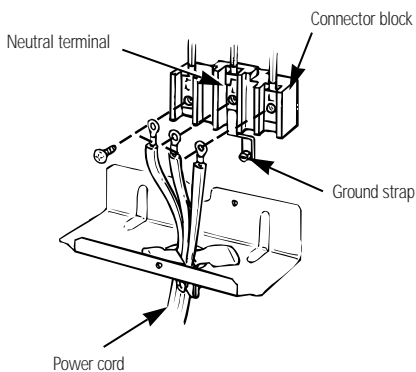



## 4-Wire Power Cord Installation

**⚠ WARNING:** The neutral wire of the supply circuit is connected to the neutral terminal located in the center of the connector block. The power leads must be connected to the outside (brass colored) terminals. The 4th grounding lead must be connected to the frame of the range with the grounding plate and grounding screw.

- a Remove the 3 screws from the connector block.
- b Remove the grounding screw and strap from the connector block middle location and the screw connection to the frame of the range.
- c Insert screws through each power cord terminal ring and into connector block until screw engages nut. Be certain that the center wire is connected to the center screw of the connector block. Tighten screws securely.
- d Attach ground wire to the frame of the range.

Before

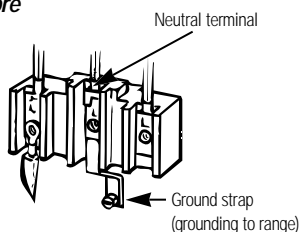

After

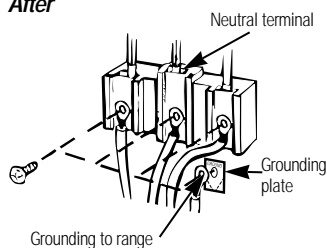

## Installation of the range.

Read these instructions completely and carefully.

### 6 3-Wire Conduit Installation

Remove the 3 screws from the connector block. Insert bare wires between the connector block terminals and movable nuts. Tighten screws securely. Do not remove ground strap connection.

**WARNING:** Connector block is approved for copper wire connection only. If aluminum wire is used, see note below.

#### NOTE: ALUMINUM WIRING

Do not connect aluminum wire to the connector block.

Use copper building wire rated for the correct amperage and voltage to make 3 (three) 3" copper jumper wires. Connect wire as per Step 6 or 7 depending on number of wires.

Splice copper wires to aluminum wiring using special connector terminals designed and UL-approved for joining copper to aluminum and follow the connector manufacturer's recommended procedure closely.

Wire used, location and enclosure of splices, etc., must conform to good wiring practices and local codes.

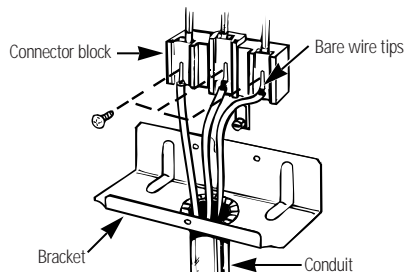
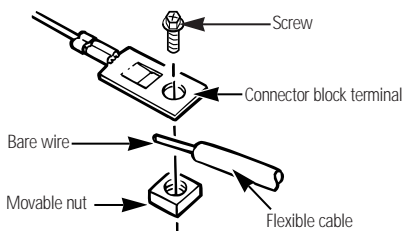

## 4-Wire Conduit Installation

Remove the 3 screws from the connector block. Remove the grounding strap from the connector block middle location and the screw connecting it to the frame of the range. Insert bare wires between the connector block terminals and movable nuts. Tighten screws securely. Attach ground wire to the frame of the range.

**WARNING:** Connector block is approved for copper wire connection only. If aluminum wire is used, see note below.

### NOTE: ALUMINUM WIRING

Do not connect aluminum wire to connector block.

Use copper building wire rated for the correct amperage and voltage to make 3 (three) 3" copper jumper wires. Connect wire as per Step 6 or 7 depending on number of wires.

Splice copper wires to aluminum wiring using special connector terminals designed and UL-approved for joining copper to aluminum and follow the connector manufacturer's recommended procedure closely.

*Wire used, location and enclosure of splices, etc., must conform to good wiring practices and local codes.*

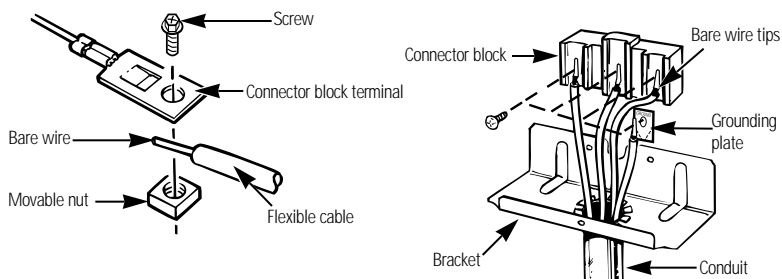

## Installation of the range.

Read these instructions completely and carefully.

### Anti-Tip Bracket Installation

An **Anti-Tip bracket** is supplied with instructions for installation in a variety of locations. The instructions include a template, a parts list and a list of tools necessary to complete the installation. Read the *Important Safety Information* and the instructions that fit your situation before beginning installation.

#### WARNING

- Range must be secured by **Anti-Tip bracket** supplied.
- See instructions to install (supplied with bracket).
- Unless properly installed, the range could be tipped by stepping or sitting on the door. Injury might result from spilled hot liquids or from the range itself.

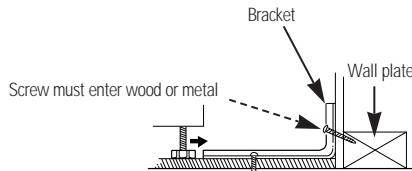

Typical installation of anti-tip bracket attachment to wall.

### Leveling the Range

The range must be level. Leveling feet are located at each corner of the base of the range. Remove the storage drawer or kick panel (depending on your model) and using channel locks, rotate the leveling feet in and out as required to level the range. (For instructions on how to remove and replace the storage drawer or the kick panel, see the *Care and cleaning of the range* section.)

On some models, there are plastic covers which may be removed for easy adjustment (just squeeze and pull).

One of the rear leveling feet will engage the **Anti-Tip bracket** (allow for some side to side adjustment). Allow a minimum clearance of 1/8" between the range and the leveling foot that is to be installed into the **Anti-Tip bracket**.

Check the range for proper installation into the **Anti-Tip bracket** by removing the kick panel or storage drawer and inspecting the rear leveling leg. Make sure it fits securely into the slot.

### Final Check

Be sure all range controls are in the OFF position before leaving the range.

## Before you call for service...



### Troubleshooting Tips

Save time and money! Review the charts on the following pages first and you may not need to call for service.

<b>Problem</b>	<b>Possible Causes</b>	<b>What To Do</b>
<i>Frequent cycling off and on of surface units</i>	<b>Improper cookware being used.</b>	<ul style="list-style-type: none"> <li>• Use only flat cookware to minimize cycling.</li> </ul>
<i>Surface units will not maintain a rolling boil or cooking is not fast enough</i>	<b>Improper cookware being used.</b>	<ul style="list-style-type: none"> <li>• Use pans which are absolutely flat and match the diameter of the surface unit selected.</li> </ul>
<i>Surface units do not work properly</i>	<b>A fuse in your home may be blown or the circuit breaker tripped.</b>	<ul style="list-style-type: none"> <li>• Replace fuse or reset circuit breaker.</li> </ul>
	<b>Cooktop controls improperly set.</b>	<ul style="list-style-type: none"> <li>• Check to see the correct control is set for the surface unit you are using.</li> </ul>
<i>Tiny scratches (may appear as cracks) or abrasions on radiant cooktop glass surface</i>	<b>Incorrect cleaning methods being used.</b>	<ul style="list-style-type: none"> <li>• Use recommended cleaning procedures.</li> </ul>
	<b>Cookware with rough bottoms being used or coarse particles (salt or sand) were between the cookware and the surface of the cooktop.</b>	<ul style="list-style-type: none"> <li>• Be sure cookware bottoms and cookware are clean before use. Use cookware with smooth bottoms. Tiny scratches are not removable but will become less visible in time as a result of cleaning.</li> </ul>
	<b>Cookware has been slid across the cooktop surface.</b>	
<i>Areas of discoloration on the cooktop</i>	<b>Improper cookware being used.</b>	<ul style="list-style-type: none"> <li>• Marks from aluminum and copper pans as well as mineral deposits from water or food can be removed with the cleaning cream.</li> </ul>
<i>Hot sugar mixtures or plastic melted to the surface</i>	<b>Hot cooktop came into contact with these substances.</b>	<ul style="list-style-type: none"> <li>• See the <i>Cleaning the glass cooktop</i> section.</li> </ul>

## Before you call for service...



### Troubleshooting Tips

<i>Problem</i>	<i>Possible Causes</i>	<i>What To Do</i>
<i>Oven light does not work</i>	<b>Light bulb is loose or defective.</b>	<ul style="list-style-type: none"> <li>• Tighten or replace the bulb.</li> </ul>
	<b>Switch operating light is broken.</b>	<ul style="list-style-type: none"> <li>• Call for service.</li> </ul>
<i>Oven will not work</i>	<b>Plug on range is not completely inserted in the electrical outlet.</b>	<ul style="list-style-type: none"> <li>• Make sure electrical plug is plugged into a live, properly grounded outlet.</li> </ul>
	<b>A fuse in your home may be blown or the circuit breaker tripped.</b>	<ul style="list-style-type: none"> <li>• Replace fuse or reset circuit breaker.</li> </ul>
	<b>Oven controls improperly set.</b>	<ul style="list-style-type: none"> <li>• See the <i>Using the oven</i> section.</li> </ul>
	<b>Door left in the locked position.</b>	<ul style="list-style-type: none"> <li>• If necessary, allow the oven to cool then unlock the door.</li> </ul>
<i>Control signals after entering cook time or stop time</i>	<b>You forgot to enter a bake temperature.</b>	<ul style="list-style-type: none"> <li>• Press the <b>CLEAR/OFF</b> pad and begin again.</li> </ul>

<b>Problem</b>	<b>Possible Causes</b>	<b>What To Do</b>
<b>Food does not broil properly</b>	<b>Oven is not set at BROIL.</b>	<ul style="list-style-type: none"> <li>• Make sure you press the <b>BROIL HI/LO</b> pad.</li> </ul>
	<b>Door not open to the broil stop position as recommended.</b>	<ul style="list-style-type: none"> <li>• See the <i>Using the oven</i> section.</li> </ul>
	<b>Improper shelf position being used.</b>	<ul style="list-style-type: none"> <li>• See the <i>Broiling guide</i>.</li> </ul>
	<b>Food being cooked in a hot pan.</b>	<ul style="list-style-type: none"> <li>• Use the broiling pan and grid that came with your range. Make sure it is cool.</li> </ul>
	<b>Cookware not suited for broiling.</b>	<ul style="list-style-type: none"> <li>• Use the broiling pan and grid that came with your range.</li> </ul>
	<b>Aluminum foil used on the broiling pan and grid has not been fitted properly and slit as recommended.</b>	<ul style="list-style-type: none"> <li>• See the <i>Using the oven</i> section.</li> </ul>
	<b>In some areas the power (voltage) may be low.</b>	<ul style="list-style-type: none"> <li>• Preheat the broil element for 10 minutes.</li> <li>• Broil for the longest period of time recommended in the <i>Broiling guide</i>.</li> </ul>
<b>Food does not bake or roast properly</b>	<b>Oven controls improperly set.</b>	<ul style="list-style-type: none"> <li>• See the <i>Using the oven</i> section.</li> </ul>
	<b>Shelf position is incorrect or the shelf is not level.</b>	<ul style="list-style-type: none"> <li>• See the <i>Using the oven</i> section.</li> </ul>
	<b>Incorrect cookware or cookware of improper size being used.</b>	<ul style="list-style-type: none"> <li>• See the <i>Using the oven</i> section.</li> </ul>
	<b>Oven thermostat needs adjustment.</b>	<ul style="list-style-type: none"> <li>• See the <i>Adjust the oven thermostat—Do it yourself!</i> section.</li> </ul>

## Before you call for service...



### Troubleshooting Tips

<b>Problem</b>	<b>Possible Causes</b>	<b>What To Do</b>
<i>Oven temperature too hot or too cold</i>	<b>Oven thermostat needs adjustment.</b>	<ul style="list-style-type: none"> <li>• See the <i>Adjust the oven thermostat—Do it yourself!</i> section.</li> </ul>
<i>Clock and timer do not work</i>	<b>Plug on range is not completely inserted in the electrical outlet.</b>	<ul style="list-style-type: none"> <li>• Make sure electrical plug is plugged into a live, properly grounded outlet.</li> </ul>
	<b>A fuse in your home may be blown or the circuit breaker tripped.</b>	<ul style="list-style-type: none"> <li>• Replace fuse or reset circuit breaker.</li> </ul>
<i>Oven will not self-clean</i>	<b>Oven controls improperly set.</b>	<ul style="list-style-type: none"> <li>• See the <i>Using the clock and timer</i> section.</li> </ul>
	<b>The oven temperature is too high to set a self-clean operation.</b>	<ul style="list-style-type: none"> <li>• Allow the range to cool to room temperature and reset the controls.</li> </ul>
	<b>Oven controls improperly set.</b>	<ul style="list-style-type: none"> <li>• See <i>Using the self-cleaning oven</i> section.</li> </ul>
<i>Oven door is not in the locked position.</i>	<b>Oven door is not in the locked position.</b>	<ul style="list-style-type: none"> <li>• Make sure you move the door latch handle all the way to the right.</li> </ul>
	<b>Oven door locked during cooking.</b>	<ul style="list-style-type: none"> <li>• Press the <b>CLEAR/OFF</b> pad. Allow the oven to cool. Never force the door latch handle.</li> </ul>
<i>Oven starts a self-clean cycle when you wanted to bake, roast or broil</i>	<b>Oven door locked during cooking.</b>	<ul style="list-style-type: none"> <li>• Press the <b>CLEAR/OFF</b> pad. Allow the oven to cool. Never force the door latch handle.</li> </ul>
<i>“Crackling” or “popping” sound</i>	<b>This is the sound of the metal heating and cooling during both the cooking and cleaning functions.</b>	<ul style="list-style-type: none"> <li>• This is normal.</li> </ul>



<b>Problem</b>	<b>Possible Causes</b>	<b>What To Do</b>
<i>Excessive smoking</i>	<b>Excessive soil.</b>	<ul style="list-style-type: none"> <li>• Press the <b>CLEAR/OFF</b> pad. Open the windows to rid the room of smoke. Wait until the <b>LOCK</b> light goes off. Wipe up the excess soil and reset the clean cycle.</li> </ul>
<i>Oven door will not unlock</i>	<b>Oven too hot.</b>	<ul style="list-style-type: none"> <li>• Allow the oven to cool below locking temperature.</li> </ul>
<i>Oven not clean after a clean cycle</i>	<b>Oven controls not properly set.</b>	<ul style="list-style-type: none"> <li>• See <i>Using the self-cleaning oven</i> section.</li> </ul>
	<b>Oven was heavily soiled.</b>	<ul style="list-style-type: none"> <li>• Clean up heavy spillovers before starting the clean cycle. Heavily soiled ovens may need to self-clean again or for a longer period of time.</li> </ul>
<i>Oven door is crooked</i>	<b>The door is out of position.</b>	<ul style="list-style-type: none"> <li>• Because the oven door is removable, it sometimes gets out of position during installation. To straighten the door, push down on the high corner.</li> </ul>
<i>"door" appears in the display</i>	<b>The self-clean cycle has been selected but the door is not locked.</b>	<ul style="list-style-type: none"> <li>• Move the door latch handle all the way to the right.</li> </ul>
	<b>The latch handle was moved to the right but a program other than self-clean was selected.</b>	<ul style="list-style-type: none"> <li>• Press the <b>CLEAR/OFF</b> pad and begin again.</li> </ul>

## Before you call for service...



### Troubleshooting Tips

<b>Problem</b>	<b>Possible Causes</b>	<b>What To Do</b>
<b>LOCK light is on when you want to cook</b>	<b>The oven door was accidentally locked.</b>	<ul style="list-style-type: none"> <li>• Press the <b>CLEAR/OFF</b> pad. Allow the oven to cool. Never force the door latch handle.</li> </ul>
<b>"F—and a number" flash in the display</b>	<b>You have a function error code.</b>	<ul style="list-style-type: none"> <li>• If a function error code appears during the self-cleaning cycle, check the oven door latch. The latch may have been moved, even if only slightly, from the locked position. Make sure the latch is moved to the right as far as it will go. Press the <b>CLEAR/OFF</b> pad. Allow the oven to cool for one hour. Put the oven back into operation.</li> <li>• Disconnect all power to the range for 5 minutes and then reconnect power. If the function error code repeats, call for service.</li> </ul>
<b>Power outage</b>	<b>Power outage or surge.</b>	<ul style="list-style-type: none"> <li>• Reset the clock. If the oven was in use, you must reset it by pressing the <b>CLEAR/OFF</b> pad, setting the clock and resetting any cooking function.</li> </ul>

## GE Electric Range Warranty



All warranty service provided by our Factory Service Centers, or an authorized Customer Care<sup>®</sup> technician. For service, call 800-GE-CARES.

<b>For The Period Of:</b>	<b>We Will Replace, At No Charge To You:</b>
<b>One Year</b> From the date of the original purchase	<b>Any part</b> of the range which fails due to a defect in materials or workmanship. During this <b>full one-year warranty</b> , we will also provide, <b>free of charge</b> , all labor and in-home service to replace the defective part.
<b>Five Years</b> From the date of the original purchase	<b>A replacement glass cooktop</b> if it should: crack due to thermal shock; discolor; crack at the rubber seal between the glass cooktop and the porcelain edge. It will also be replaced if the pattern wears off or if any of the radiant surface units burn out. During this <b>five-year limited warranty</b> , you will be responsible for any labor or in-home service costs.

### What GE Will Not Cover:

- Service trips to your home to teach you how to use the product.
- Improper installation.
- Failure of the product if it is abused, misused, or used for other than the intended purpose or used commercially.
- Damage to the glass cooktop caused by use of cleaners other than the recommended cleaning creams.
- Damage to the glass cooktop caused by hardened spills of sugary materials or melted plastic that are not cleaned according to the directions in the Owner's Manual.
- Replacement of house fuses or resetting of circuit breakers.
- Damage to the product caused by accident, fire, floods or acts of God.
- Incidental or consequential damage to personal property caused by possible defects with this appliance.

This warranty is extended to the original purchaser and any succeeding owner for products purchased for home use within the USA. In Alaska, the warranty excludes the cost of shipping or service calls to your home.

Some states do not allow the exclusion or limitation of incidental or consequential damages. This warranty gives you specific legal rights, and you may also have other rights which vary from state to state. To know what your legal rights are, consult your local or state consumer affairs office or your state's Attorney General.

## Service Telephone Numbers.

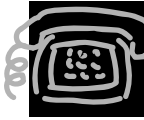

### GE Answer Center® 800.626.2000

The GE Answer Center® is open 24 hours a day, 7 days a week.



### In-Home Repair Service 800-GE-CARES (800-432-2737)

Expert GE repair service is only a phone call away.



### Special Needs Service 800.626.2000

#### TDD 800-TDD-GEAC (800-833-4322)

GE offers, free of charge, a brochure to assist in planning a barrier-free kitchen for persons with limited mobility.



### Service Contracts 800-626-2224

Purchase a GE service contract while your warranty is still in effect and you'll receive a substantial discount. GE Consumer Service will still be there after your warranty expires.

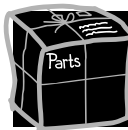

### Parts and Accessories 800-626-2002

Individuals qualified to service their own appliances can have parts or accessories sent directly to their homes (VISA, MasterCard and Discover cards are accepted).

*Instructions contained in this manual cover procedures to be performed by any user. Other servicing generally should be referred to qualified service personnel. Caution must be exercised, since improper servicing may cause unsafe operation.*



### Service Satisfaction

If you are not satisfied with the service you receive from GE, follow these three steps. **First**, contact the people who serviced your appliance. **Next**, if you are still not pleased, write all the details—including your phone number—to: Manager, Consumer Relations, GE Appliances, Appliance Park, Louisville, KY 40225. **Finally**, if your problem is still not resolved, write:

Major Appliance Consumer Action Program  
20 North Wacker Drive, Chicago, IL 60606.

## Free Manuals Download Website

<http://myh66.com>

<http://usermanuals.us>

<http://www.somanuals.com>

<http://www.4manuals.cc>

<http://www.manual-lib.com>

<http://www.404manual.com>

<http://www.luxmanual.com>

<http://aubethermostatmanual.com>

Golf course search by state

<http://golfingnear.com>

Email search by domain

<http://emailbydomain.com>

Auto manuals search

<http://auto.somanuals.com>

TV manuals search

<http://tv.somanuals.com>