

Owner's Manual

Range



Electric Ranges

*Coil Top and
Radiant Top Models*

GE Answer Center® 800.626.2000

Part No. 164D3333P159 Pub. No. 49-8927 1-99 CG

Download from Www.Somanuals.com. All Manuals Search And Download.

Congratulations! ***You Are Now Part of Our Family.***

Welcome to our family. We're proud of our quality products and we are committed to providing dependable service. You'll see it in this easy-to-use Owner's Manual and you'll hear it in the friendly voices of our customer service department.

Best of all, you'll experience these values each time you use your range. That's important, because your new range will be part of your family for many years. And we hope you will be part of ours for a long time to come.

We thank you for buying our product. We appreciate your purchase and hope you will continue to rely on us whenever you need quality appliances for your home.



Important!

Staple sales slip or cancelled check here.

Proof of the original purchase date is needed to obtain service under the warranty.



Write the model and serial numbers here.

You can find them on a label behind the range door or behind the storage drawer.



A Service Partnership.

Ask owners of any of our appliances and they will tell you we stand behind our products with unmatched quality service. However, did you know that most questions result from simple problems that you can easily fix yourself in just a few minutes? This Owner's Manual can tell you how.



Read this Manual

Inside you will find many helpful hints on how to use and maintain your range properly. Just a little preventive care on your part can save you a great deal of time and money over the life of your range.



Review the Section on Troubleshooting Tips

You'll find many answers to common problems here. If you review our chart of Troubleshooting Tips first, you may not need to call for service at all.



If You Need Service

If you do need service, you can relax knowing help is only a phone call away. A list of toll-free customer service numbers is included in the back section. Or you can always call the GE Answer Center[®] at 800.626.2000, 24 hours a day, 7 days a week.

Safety Information

Anti-Tip Device	4
Safety Precautions	5-7
Oven	8
Self-Cleaning Oven	9
Surface Units	10-12

Safety Information

Operating Instructions

Using the Surface Units . . .	13-16
Using the Oven	17-27
Using the Clock and Timer . . .	22
Timed Baking and Roasting . .	23
Oven Thermostat	24, 25
Using the Self-Cleaning Oven	26, 27
Care and Cleaning	28-36

Operating Instructions

Installation Instructions

Before You Begin	37
Prepare the Opening	38
Flooring	39
Electrical Connection	39-44
Anti-Tip Bracket	45
Leveling	45

Installation Instructions

Troubleshooting Tips

Before You	
Call For Service	46-52

Troubleshooting Tips

Customer Service

Warranty	55
Service Telephone	
Numbers	Back Cover

Customer Service

IMPORTANT SAFETY INFORMATION. READ ALL INSTRUCTIONS BEFORE USING.

! WARNING!

For your safety, the information in this manual must be followed to minimize the risk of fire or explosion, electric shock, or to prevent property damage, personal injury, or loss of life.



! WARNING ANTI-TIP DEVICE

All ranges can tip and injury could result.

To prevent accidental tipping of the range, attach it to the wall and floor by installing the Anti-Tip device supplied.



To check if the device is installed and engaged properly, remove the storage drawer and inspect the rear leveling leg. Make sure it fits securely into the slot.



If you pull the range out from the wall for any reason, make sure the device is properly engaged when you push the range back against the wall. If it is not, there is a possible risk of the range tipping over and causing injury if you or a child stand, sit or lean on an open door.

Please refer to the Anti-Tip device information in this manual. Failure to take this precaution could result in tipping of the range and injury.



IMPORTANT SAFETY NOTICE

The California Safe Drinking Water and Toxic Enforcement Act requires the Governor of California to publish a list of substances known to the state to cause cancer, birth defects or other reproductive harm, and requires businesses to warn customers of potential exposure to such substances.

The fiberglass insulation in self-clean ovens gives off a very small amount of carbon monoxide during the cleaning cycle. Exposure can be minimized by venting with an open window or using a ventilation fan or hood.

Use this appliance only for its intended purpose as described in this Owner's Manual.



SAFETY PRECAUTIONS

When using electrical appliances, basic safety precautions should be followed, including the following:

- Be sure your appliance is properly installed and grounded by a qualified technician in accordance with the provided installation instructions.
- Do not attempt to repair or replace any part of your range unless it is specifically recommended in this manual. All other servicing should be referred to a qualified technician.
- Before performing any service, disconnect the range power supply at the household distribution panel by removing the fuse or switching off the circuit breaker.
- Do not leave children alone—children should not be left alone or unattended in an area where an appliance is in use. They should never be allowed to sit or stand on any part of the appliance.
- Do not allow anyone to climb, stand or hang on the door, storage drawer or cooktop. They could damage the range and even tip it over, causing severe personal injury.
- Do not store flammable materials in an oven or near the cooktop.
- **CAUTION:** Items of interest to children should not be stored in cabinets above a range or on the backsplash of a range—children climbing on the range to reach items could be seriously injured.
- Never wear loose-fitting or hanging garments while using the appliance. Be careful when reaching for items stored over the range. Flammable material could be ignited if brought in contact with hot surface units or heating elements and may cause severe burns.

IMPORTANT SAFETY INFORMATION. READ ALL INSTRUCTIONS BEFORE USING.



! WARNING! **SAFETY PRECAUTIONS**

- Use only dry pot holders—moist or damp pot holders on hot surfaces may result in burns from steam. Do not let pot holders touch hot surface units or heating elements. Do not use a towel or other bulky cloth.
- For your safety, never use your appliance for warming or heating the room.
- Do not store or use combustible materials, gasoline or other flammable vapors and liquids in the vicinity of this or any other appliance.
- Keep the hood and grease filters clean to maintain good venting and to avoid grease fires.
- Do not let cooking grease or other flammable materials accumulate in or near the range.
- Do not use water on grease fires. Never pick up a flaming pan. Turn the controls off. Smother a flaming pan on a surface unit by covering the pan completely with a well-fitting lid, cookie sheet or flat tray. Use a multi-purpose dry chemical or foam-type fire extinguisher. Flaming grease outside a pan can be put out by covering it with baking soda or, if available, by using a multi-purpose dry chemical or foam-type fire extinguisher. Flame in the oven can be smothered completely by closing the oven door and turning the oven off or by using a multi-purpose dry chemical or foam-type fire extinguisher.

- Do not touch the surface units, the heating elements or the interior surface of the oven. These surfaces may be hot enough to burn even though they are dark in color. During and after use, do not touch, or let clothing or other flammable materials contact, the surface units, areas nearby the surface units or any interior area of the oven; allow sufficient time for cooling first.

Potentially hot surfaces include the cooktop, areas facing the cooktop, oven vent opening, surfaces near the opening, crevices around the oven door and metal trim parts above the door.

REMEMBER : The inside surface of the oven may be hot when the door is opened.



COOK MEAT AND POULTRY THOROUGHLY...

Cook meat and poultry thoroughly—meat to at least an INTERNAL 160°F. and poultry to at least an INTERNAL 180°F. Cooking to these temperatures usually protects against foodborne illness.

IMPORTANT SAFETY INFORMATION. READ ALL INSTRUCTIONS BEFORE USING.

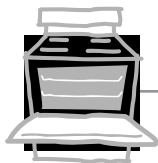

⚠ WARNING! OVEN

- Stand away from the range when opening the oven door. Hot air or steam which escapes can cause burns to hands, face and/or eyes.
- Do not heat unopened food containers. Pressure could build up and the container could burst, causing an injury.
- Keep the oven vent unobstructed.
- Keep the oven free from grease buildup.
- Place the oven shelf in the desired position while the oven is cool. If shelves must be handled when hot, do not let pot holder contact the heating elements.
- Pulling out the shelf to the stop-lock is a convenience in lifting heavy foods. It is also a precaution against burns from touching hot surfaces of the door or oven walls.
- When using cooking or roasting bags in the oven, follow the manufacturer's directions.
- Do not use the oven to dry newspapers. If overheated, they can catch on fire.
- Do not use the oven for a storage area. Items stored in an oven can ignite.
- Do not leave paper products, cooking utensils or food in the oven when not in use.



SELF-CLEANING OVEN *(on some models)*

- Do not clean the door gasket. The door gasket is essential for a good seal. Care should be taken not to rub, damage or move the gasket.
- Clean only parts listed in this Owner's Manual.
- Do not use oven cleaners on self-clean models. No commercial oven cleaner or oven liner protective coating of any kind should be used in or around any part of the oven. Residue from oven cleaners will damage the inside of the oven when the self-clean cycle is used.
- Before self-cleaning the oven, remove the broiler pan, grid and other cookware.
- Be sure to wipe up excess spillage before starting the self-cleaning operation.
- If the self-cleaning mode malfunctions, turn the oven off and disconnect the power supply. Have it serviced by a qualified technician.

IMPORTANT SAFETY INFORMATION. READ ALL INSTRUCTIONS BEFORE USING.



⚠ WARNING! SURFACE UNITS—ALL MODELS

Use proper pan size—select cookware having flat bottoms large enough to cover the surface unit heating element. The use of undersized cookware will expose a portion of the surface unit to direct contact and may result in ignition of clothing. Proper relationship of cookware to surface unit will also improve efficiency.

- Never leave the surface units unattended at high heat settings. Boilovers cause smoking and greasy spillovers that may catch on fire.
- Use little fat for effective shallow or deep fat frying. Filling the pan too full of fat can cause spillovers when food is added.
- If a combination of oils or fats will be used in frying, stir together before heating, or as fats melt slowly.
- Always heat fat slowly, and watch as it heats.
- Only certain types of glass, glass/ceramic, earthenware or other glazed containers are suitable for cooktop service; others may break because of the sudden change in temperature.
- To minimize the possibility of burns, ignition of flammable materials and spillage, the handle of a container should be turned toward the center of the range without extending over nearby surface units.
- Always turn the surface units off before removing cookware.
- When flaming foods under the hood, turn the fan on.
- Use a deep fat thermometer whenever possible to prevent overheating fat beyond the smoking point.
- Keep an eye on foods being fried at high or medium high heat settings.
- Foods for frying should be as dry as possible. Frost on frozen foods or moisture on fresh foods can cause hot fat to bubble up and over the sides of the pan.

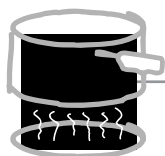

⚠ WARNING!

RADIANT SURFACE UNITS (on some models)

Use care when touching the cooktop. The glass surface of the cooktop will retain heat after the controls have been turned off.

- When the cooktop is cool, use only the recommended cleaning cream to clean the cooktop.
- To avoid possible damage to the cooking surface, do not apply cleaning cream to the glass surface when it is hot.
- After cleaning, use a dry cloth or paper towel to remove all cleaning cream residue.
- Read and follow all instructions and warnings on the cleaning cream labels.
- Never use the glass cooktop surface as a cutting board.
- Avoid scratching the glass cooktop. The cooktop can be scratched with items such as sharp instruments, rings or other jewelry and rivets on clothing.
- Do not place or store items that can melt or catch fire on the glass cooktop, even when it is not being used.
- Do not operate the radiant surface units if the glass is broken. Spillovers or cleaning solution may penetrate a broken cooktop and create a risk of electrical shock. Contact a qualified technician immediately should your glass cooktop become broken.
- Be careful when placing spoons or other stirring utensils on glass cooktop surface when it is in use. They may become hot and could cause burns.
- Clean the cooktop with caution. If a wet sponge or cloth is used to wipe spills on a hot surface unit, be careful to avoid steam burns. Some cleaners can produce noxious fumes if applied to a hot surface.

NOTE: We recommend that you avoid wiping any surface unit areas until they have cooled and the indicator light has gone off. Sugar spills are the exception to this. Please see *Cleaning the glass*

IMPORTANT SAFETY INFORMATION. READ ALL INSTRUCTIONS BEFORE USING.



⚠ WARNING! **COIL SURFACE UNITS** *(on some models)*

- Clean the cooktop with caution. If a wet sponge is used to wipe spills on a hot cooktop, be careful to avoid steam burns.
- To avoid the possibility of a burn or electric shock, always be certain that the controls for all surface units are at the **OFF** position and all coils are cool before attempting to lift or remove a unit.
- Do not immerse or soak the removable surface units. Do not put them in a dishwasher.
- Be sure the drip pans and the vent duct are not covered and are in place. Their absence during cooking could damage range parts and wiring.
- Do not use aluminum foil to line the drip pans or anywhere in the oven except as described in this manual. Misuse could result in a shock, fire hazard or damage to the range.



Read and follow this Safety Information carefully.

SAVE THESE INSTRUCTIONS

Using the surface units.

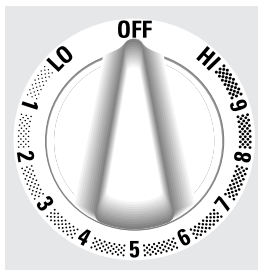

Be sure you turn the control knob to OFF when you finish cooking. (appearance may vary)

How to Set

Push the knob in and turn in either direction to the setting you want.

At both **OFF** and **HI** the control **clicks** into position. You may hear slight **clicking** sounds during cooking, indicating the control is keeping the power level you set.

Indicator Lights (on radiant glass models only)

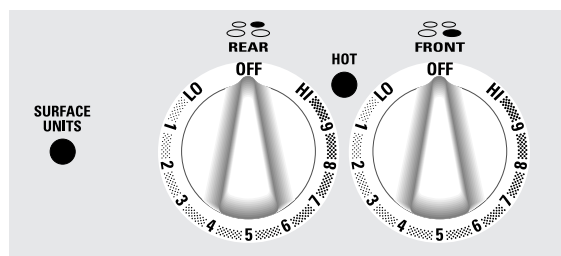

A **HOT** indicator light will glow when any radiant element is turned on, and will remain on until the surface is cool enough to touch.

A **SURFACE UNITS** on indicator light will glow when any surface unit is on.

NOTE: The **SURFACE UNITS** on indicator light may glow between the surface control settings of **LO** and **OFF**, but there is no power to the surface units.

Using the radiant surface units *(on some models)*



Never cook directly on the glass.
Always use cookware.



Always place the pan in the center of
the surface unit you are cooking on.

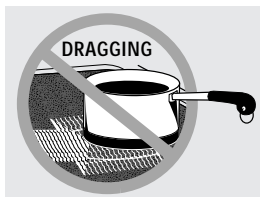

About the radiant surface units...

The radiant cooktop features heating units beneath a smooth glass surface.

NOTE: A slight odor is normal when a new cooktop is used for the first time. It is caused by the heating of new parts and insulating materials and will disappear in a short time.

The surface unit will cycle on and off to maintain your selected control setting.

It is safe to place hot cookware from the oven or surface on the glass surface when the surface is cool.

Even after the surface units are turned off, the glass cooktop retains enough heat to continue cooking. To avoid over-cooking, remove pans from the surface units when the food is cooked. Avoid placing anything on the surface unit until it has cooled completely.

- Water stains (mineral deposits) are removable using the cleaning cream or full strength white vinegar.
- Use of window cleaner may leave an iridescent film on the cooktop. The cleaning cream will remove this discoloration.
- Don't store heavy items above the cooktop. If they drop onto the cooktop, they can cause damage.
- Do not use the surface as a cutting board.

Do not slide cookware across the cooktop because it can scratch the glass—the glass is scratch resistant, not scratch proof.

Selecting types of cookware for radiant glass cooktop models.

The following information will help you choose cookware which will give good performance on glass cooktops.

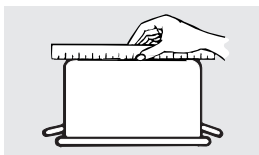

Check pans for flat bottoms by using a straight edge.



Pans with rounded, curved, ridged or warped bottoms are not recommended.

Stainless Steel:

recommended

Aluminum:

heavy weight recommended

Good conductivity. Aluminum residues sometimes appear as scratches on the cooktop, but can be removed if cleaned immediately. Because of its low melting point, thin weight aluminum should not be used.

Copper Bottom:

recommended

Copper may leave residues which can appear as scratches. The residues can be removed, as long as the cooktop is cleaned immediately. However, do not let these pots boil dry. Overheated metal can bond to glass cooktops. An overheated copper bottom pot will leave a residue that will permanently stain the cooktop if not removed immediately.

Porcelain Enamel Covered Cast Iron:

recommended

As long as the cookware is covered completely with porcelain enamel, this cookware is recommended. Caution is recommended for cast iron cookware that is not completely covered with smooth porcelain enamel, as it may scratch the glass ceramic cooktop.

Glass-ceramic:

usable, but not recommended

Poor performance. May scratch the surface.

Stoneware:

usable, but not recommended

Poor performance. May scratch the surface.

Selecting types of cookware for coil cooktop models.

The following information will help you choose cookware which will give good performance on coil cooktops.

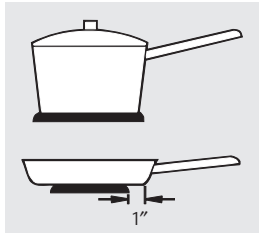

Not over 1 inch

Surface Cookware Tips

Use medium- or heavy-weight cookware. Aluminum cookware conducts heat faster than other metals. Cast-iron and coated cast-iron cookware are slow to absorb heat, but generally cook evenly at low to medium heat settings. Steel pans may cook unevenly if not combined with other metals.

For best cooking results, pans should be flat on the bottom. Match the size of the saucepan to the size of the surface unit. The pan should not extend over the edge of the surface unit more than 1 inch.

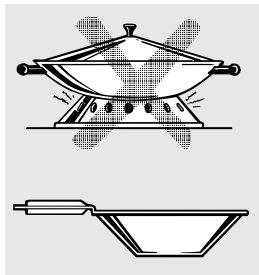

Use only flat-bottomed woks.

Wok Cooking

We recommend that you use only a flat-bottomed wok. They are available at your local retail store.

Do not use woks that have support rings. Use of these types of woks, with or without the ring in place, can be dangerous. Placing the ring over the surface unit will cause a build-up of heat that will damage the porcelain cooktop. Do not try to use such woks without the ring. You could be seriously burned if the wok tipped over.

Using the oven controls.

Throughout this manual, features and appearance may vary from your model.

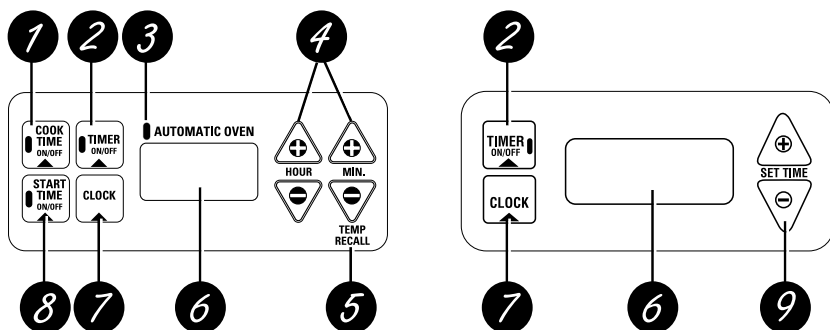

Clock and Timer Features

- 1** *COOK TIME ON/OFF Pad*
Press this pad and then press the **HOUR** and **MIN.** pads to set the amount of time you want your food to cook. Turn the Oven Temperature knob to the desired temperature. The oven will shut off when the Cook Time has run out.
- 2** *TIMER ON/OFF Pad*
Press this pad to select the timer feature.
- 3** *AUTOMATIC OVEN Light*
This lights anytime the oven has been programmed.
- 4** *HOUR and MIN. Pads*
These pads allow you to set times up to 11 hours and 59 minutes.
- 5** *TEMP RECALL*
Press the **-** pad above **TEMP RECALL** to display the selected oven temperature.
- 6** *Display*
Shows the time of day and the time set for the timer.
- 7** *CLOCK Pad*
Press this pad before setting the clock.
- 8** *START TIME ON/OFF Pad*
Press this pad and the **HOUR** and **MIN.** pads to delay the starting of your oven up to 11 hours and 59 minutes.
- 9** *SET TIME +/- Pads*
These pads allow you to set the clock and timer.



Using the oven controls. (on some models)

Throughout this manual, features and appearance may vary from your model.

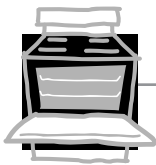
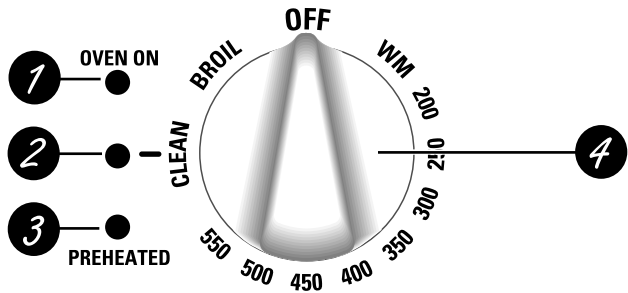

Oven Control Settings

On some models you may use the oven light switch to turn the light on and off when the door is closed.

- 1** **OVEN ON Light**
Glow anytime the oven is heating. The light will flash when the oven automatically turns off to remind you to turn the Oven Temperature knob to **OFF**.
 - 2** **CLEAN Light**
Glow when the oven is in the self-clean cycle. After the self-clean cycle, the light will flash. Unlatch the door and turn the Oven Temperature knob to **OFF**. If the door will not unlatch, wait approximately 30 minutes and try again.
- NOTE:** Do not lock the oven door with the latch during cooking. The latch is used for self-cleaning only. Never force the latch handle. You may damage the door lock.
- 3** **PREHEATED Light**
Glow when the oven reaches your selected temperature.
 - 4** **Oven Temperature Knob**
Turn this knob to the setting you want. On some models, the temperature will be displayed to indicate setting. The display will change back to time after a few seconds.

On some models, the oven will automatically shut off after 12 hours.

On models with touch pad clock controls this feature may be deactivated to allow the oven to be left on for more than 12 hours.

To deactivate or reactivate the Automatic Oven Shut-Off, press and hold both the MIN. +/- pads for about 4 seconds.

Using the oven.

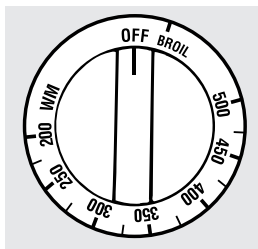

Oven Temperature Knob (on some models)

Turn this knob to the setting you want.

- The oven cycling light glows until the oven reaches your selected temperature, then goes off and on with the oven element(s) during cooking.

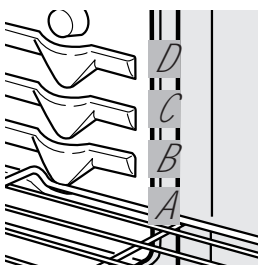

The oven has 4 shelf positions.

Before you begin...

To avoid possible burns, place the shelves in the desired position before you turn the oven on.

The shelves have stop-locks, so that when placed correctly on the supports, they will stop before coming completely out, and will not tilt.

When placing and removing cookware, pull the shelf out to the bump on the shelf support.

To remove a shelf, pull it toward you, tilt the front end up and pull it out.

To replace, place the end of the shelf (stop-locks) on the support, tilt the front and push the shelf in.

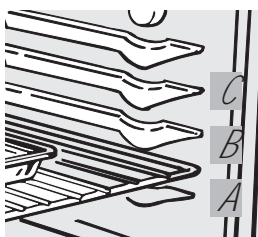

How to Set the Oven for Baking or Roasting

- 1 Turn the Oven Temperature knob to the temperature you desire.
- 2 Check food for doneness at minimum time on recipe. Cook longer if necessary.
- 3 Turn the Oven Temperature knob to **OFF** when cooking is complete.

Type of Food	Shelf Position
Angel food cake and frozen pies (on cookie sheet)	A
Bundt or pound cakes	B
Biscuits, muffins, brownies, cookies, cupcakes, layer cakes, pies	B or C
Casseroles	B or C

Using the oven.

Preheating and Pan Placement

Preheat the oven if the recipe calls for it. To preheat, set the oven at the correct temperature. Preheating is necessary for good results when baking cakes, cookies, pastry and breads.

For ovens without a preheat indicator light or tone, preheat 10 minutes.

Baking results will be better if baking pans are centered in the oven as much as possible. Pans should not touch each other or the walls of the oven. If you need to use two shelves, stagger the pans so one is not directly above the other, and leave approximately 1½" from the front of the pan to the front of the shelf.

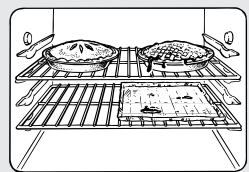

Aluminum foil may be used to catch a spillover.

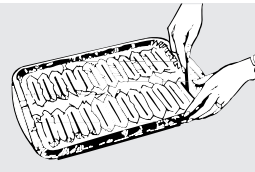

Aluminum Foil

Never entirely cover a shelf with aluminum foil. This will disturb the heat circulation and result in poor baking.

A smaller sheet of foil may be used to catch a spillover by placing it on a lower shelf several inches below the food.

You can also use aluminum foil to line the broiler pan and broiler grid. However, you must mold the foil tightly to the grid and cut slits in it just like the grid.

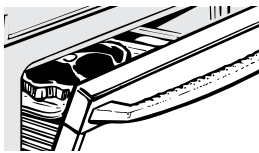

Leave the door open to the broil stop position. The door stays open by itself, yet the proper temperature is maintained in the oven.

How to Set the Oven for Broiling

- 1 Place the food on the broiler grid in the broiler pan.
- 2 Follow suggested shelf positions in the *Broiling guide*.
- 3 Turn the Oven Temperature knob to **BROIL**.

Broiling guide

Food	Quantity and/or Thickness	Shelf Position	First Side Time (min.)	Second Side Time (min.)	Comments
Bacon	1/2 lb. (about 8 thin slices)	C	4½	4½	Arrange in single layer.
Ground Beef Well Done	1 lb. (4 patties) 1/2 to 3/4" thick	C	10	7	Space evenly. Up to 8 patties take about same time.
Beef Steaks Rare Medium Well Done	1" thick (1 to 1½ lbs.)	C C C	6 8 12	5 6 11	Steaks less than 1" thick cook through before browning. Pan frying is recommended.
Rare Medium Well Done	1½" thick (2 to 2½ lbs.)	C C C	10 15 25	7-8 14-16 20-25	Slash fat.
Chicken	1 whole (2 to 2½ lbs.), split lengthwise	A	35	10-15	Reduce time about 5 to 10 minutes per side for cut-up chicken. Brush each side with melted butter. Broil skin-side-down first.
Lobster Tails	2-4 (6 to 8 oz. each)	B	13-16	Do not turn over.	Cut through back of shell. Spread open. Brush with melted butter before broiling and after half of broiling time.
Fish	1-lb. fillets 1/4 to 1/2" thick	C	5	5	Handle and turn very carefully. Brush with lemon butter before and during cooking, if desired. Preheat broiler to increase browning.
Ham Slices (precooked)	1" thick	B	8	8	Increase time 5 to 10 minutes per side for 1½" thick or home cured ham.
Pork Chops Well Done	2 (1½" thick) 2 (1" thick), about 1 lb.	C B	10 13	10 13	Slash fat.
Lamb Chops Medium Well Done Medium Well Done	2 (1" thick), about 10 to 12 oz. 2 (1½" thick), about 1 lb.	C C C B	10 12 14 17	9 10 12 12-14	Slash fat.

Using the clock and timer. (on some models)



Make sure the clock is set to the correct time of day.

The clock must be set for the automatic oven timing functions to work properly. The time of day cannot be changed during a timed baking or self-cleaning cycle.

To Set the Clock:

- 1 Press the **CLOCK** pad.
- 2 Press the **HOUR** and **MIN.** or **SET TIME +/-** pads.
- 3 Press the **CLOCK** pad to start.



The timer is a minute timer only. The timer does not control oven operations. The maximum setting on the timer is 11 hours and 59 minutes, or 9 hours and 50 minutes, depending on your model.

To Set the Timer:

- 1 Press the **TIMER ON/OFF** pad.
- 2 Press the **HOUR** and **MIN.** or **SET TIME +/-** pads until the amount of time you want shows in the display. The timer will start automatically within a few seconds of releasing the pad.

To Reset the Timer:

If the display is still showing the time remaining, you may change it by pressing the **HOUR** and **MIN.** or **SET TIME +/-** pads until the time you want appears in the display.

If the remaining time is not in the display, recall the remaining time by pressing the **TIMER ON/OFF** pad and then pressing the **HOUR** and **MIN.** or **SET TIME +/-** pads until the new time you want shows in the display.

To Cancel the Timer:

Press the **TIMER ON/OFF** pad once. To cancel the timer press the **TIMER ON/OFF** pad again and hold for 4 seconds.

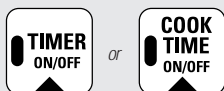

End of Cycle Tones (on some models)

Clear the tones by pressing the pad of the function you are using.

Using the timed baking and roasting features. (on some models)

Do not latch the oven door during timed cooking. The latch is used for self-cleaning only.

NOTE: Foods that spoil easily, such as milk, eggs, fish, stuffings, poultry and pork, should not be allowed to sit for more than 1 hour before or after cooking. Room temperature promotes the growth of harmful bacteria. Be sure that the oven light is off because heat from the bulb will speed harmful bacteria growth.

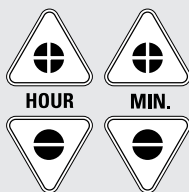

How to Set an Immediate Start and Automatic Stop

Make sure the oven clock shows the correct time of day.

- 1 Press **COOK TIME ON/OFF**.
- 2 Using the **HOUR** and **MIN.** pads, enter the length of cooking time.
- 3 Turn the Oven Temperature knob to the desired temperature.

The display will show the cooking time remaining. When the oven reaches the set temperature, a tone sounds.

When the oven automatically turns off the **AUTOMATIC OVEN** light will flash and the oven will signal. Turn the oven control to **OFF** to stop the flashes and signal.

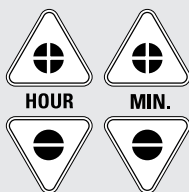

How to Set a Delay Start and Automatic Stop

Make sure the oven clock shows the correct time of day.

- 1 Press **START TIME ON/OFF**.
- 2 Using the **HOUR** and **MIN.** pads, enter the time you want cooking to start.
- 3 Press **COOK TIME ON/OFF**.
- 4 Using the **HOUR** and **MIN.** pads, enter length of cooking time.
- 5 Turn the Oven Temperature knob to the desired temperature.

When the oven automatically turns off the **AUTOMATIC OVEN** light will flash and the oven will signal. Turn the Oven Temperature knob to **OFF** to stop the flashes and signal.

Adjust the oven thermostat—Easy to do yourself!

You may find that your new oven cooks differently than the one it replaced. Use your new oven for a few weeks to become more familiar with it. If you still think your new oven is too hot or too cold, you can adjust the thermostat yourself.

Do not use thermometers, such as those found in grocery stores, to check the temperature setting of your oven. These thermometers may vary 20–40 degrees.

NOTE: This adjustment will not affect the broiling or the self-cleaning temperatures (on some models). The adjustment will be retained in memory after a power failure.

For Self-Cleaning Models with Only an Oven Temperature Knob

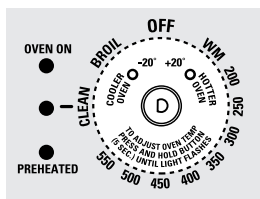
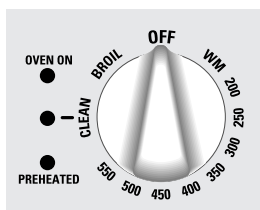

(appearance may vary)

- 1 Put the knob in the **OFF** position.
- 2 Pull the knob off by pulling straight out.
- 3 Press and hold the **HOTTER** or **COOLER** button for 5 seconds to make the oven 20°F. hotter or 20°F. cooler.
- 4 Replace the knob.

When you are adjusting the thermostat, the following lights will flash indicating where the thermostat will be set when you release the adjustment button:

- **OVEN ON:** Indicates the thermostat will be set at the factory setting.
- **PREHEATED:** Indicates the thermostat will be set 20°F. hotter.
- **CLEAN:** Indicates the thermostat will be set 20°F. cooler.

For Self-Cleaning Models with Pads and an Oven Temperature Knob



- 1 Put the Oven Temperature knob in the **OFF** position.
- 2 Press and hold the **HOUR +/-** pads for 5 seconds until the display changes.
- 3 Before display changes back, press the **HOUR +/-** pads to increase or decrease the temperature in 5 degree increments.

The oven temperature can be increased up to 35°F. hotter or can be decreased down to 35°F. cooler.

If the oven adjustment is set cooler than the factory setting a minus sign (–) and the offset temperature will appear in the display.

- 4 Wait several seconds for the control to automatically set and return to its previous setting.

To Adjust the Thermostat on Standard Clean Models

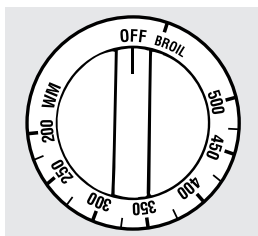

Front of OVEN TEMP knob
(knob appearance may vary)

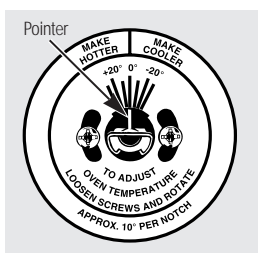

Back of OVEN TEMP knob

- 1 Pull the Oven Temp knob off the shaft, look at the back of the knob and note the current setting *before* making any adjustments.
- 2 Loosen both screws on the back of the knob.
- 3 To **increase** the oven temperature, move the pointer 1 notch toward the words **"MAKE HOTTER."**
To **decrease** the oven temperature, turn the pointer 1 notch toward the words **"MAKE COOLER."**
Each notch changes the temperature by 10 degrees Fahrenheit.
- 4 Tighten the screws.
- 5 Replace the knob, matching the flat area of the knob to the shaft.

The type of margarine will affect baking performance!

Most recipes for baking have been developed using high fat products such as butter or margarine (80% fat). If you decrease the fat, the recipe may not give the same results as with a higher fat product.

Recipe failure can result if cakes, pies, pastries, cookies or candies are made with low fat spreads. The lower the fat content of a spread product, the more noticeable these differences become.

Federal standards require products labeled "margarine" to contain at least 80% fat by weight. Low fat spreads, on the other hand, contain less fat and more water. The high moisture content of these spreads affects the texture and flavor of baked goods. For best results with your old favorite recipes, use margarine, butter or stick spreads containing at least 70% vegetable oil.

Using the self-cleaning oven (on some models).

Never force the latch handle. Forcing the handle will damage the door lock mechanism.

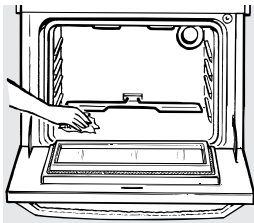

Wipe up heavy soil on the oven bottom.

Before a Clean Cycle

The range must be completely cool in order to set the self-clean cycle.

We recommend venting with an open window or using a ventilation fan or hood during the first self-clean cycle.

Remove all cookware and any aluminum foil from the oven.

The oven shelves can be self-cleaned, but they will darken, lose their luster and become hard to slide.

Do not use abrasives or oven cleaners. Clean the top, sides and outside of the oven door with soap and water.

The enamel grid and broiler pan may be cleaned in the self-cleaning oven. However, to help prevent heavy smoke caused by self-cleaning the greasy soil in the pan, you must first clean off the excess grease.

Make sure the oven light bulb cover is in place and the oven light is off.

IMPORTANT: The health of some birds is extremely sensitive to the fumes given off during the self-cleaning cycle of any range. Move birds to another well ventilated room.

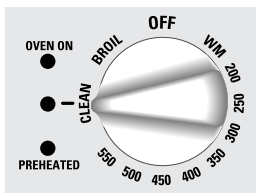

How to Set the Oven for Cleaning

- 1 Latch the door.
- 2 Turn the Oven Temperature knob to **CLEAN**.

Clean cycle time is normally 4 hours and 20 minutes. You can change the clean time to between 3 hours and 5 hours, 59 minutes by using the **HOUR** and **MIN.** pads.

When the **CLEAN** light flashes, and the oven has completely cooled, slide the latch handle to the left, and turn the Oven Temperature knob to **OFF**. Never force the latch handle. You may damage the door lock.

To stop a clean cycle, turn the Oven Temperature knob to **OFF**. Wait until the oven has cooled and unlatch the door.

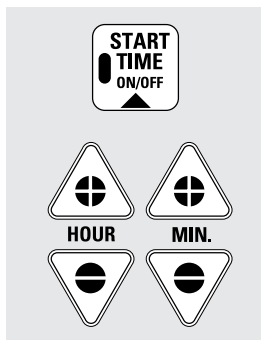
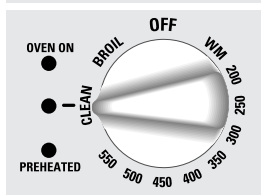
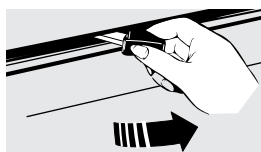

How to Delay the Start of Cleaning

(on some models)

- 1 Latch the door.
- 2 Turn the Oven Temperature knob to **CLEAN**.
- 3 Press the **START TIME ON/OFF** pad.
- 4 Press the **HOUR** and **MIN.** pads to set the time cleaning will start.

When the **CLEAN** light flashes, and the oven has completely cooled, slide the latch handle to the left as far as it will go and turn the Oven Temperature knob to **OFF**.

After a Clean Cycle

You may notice some white ash in the oven. Wipe it up with a damp cloth after the oven cools.

If white spots remain, remove them with a soap-filled steel wool pad and rinse thoroughly with a vinegar and water mixture.

These deposits are usually a salt residue that cannot be removed by the clean cycle.

If the oven is not clean after one clean cycle, repeat the cycle.

- You cannot set the oven for cooking until the oven is cool enough for the door to be unlatched.
- While the oven is self-cleaning, you can press the **CLOCK** pad to display the time of day. To return to the clean countdown, press the **COOK TIME ON/OFF** pad.
- If the shelves become hard to slide, apply a small amount of vegetable oil or cooking oil to a paper towel and wipe the edges of the oven shelves with the paper towel.

Care and cleaning of the range.

Oven Interior (non-self clean models)

With proper care, the porcelain enamel finish on the inside of the oven—top, bottom, sides, back and inside of the door—will stay new-looking for years.

Let the range cool before cleaning. We recommend that you wear rubber gloves when cleaning the range.

Soap and water will normally do the job. Heavy spattering or spillovers may require cleaning with a mild abrasive cleaner. Soapy, wet metal pads may also be used.

Do not allow food spills with a high sugar or acid content (such as milk, tomatoes, sauerkraut, fruit juices or pie filling) to remain on the surface. They may cause a dull spot even after cleaning.

Household ammonia may make the cleaning job easier. Place 1/2 cup in a shallow glass or pottery container in a cold oven overnight. The ammonia fumes will help loosen the burned-on grease and food.

If necessary, you may use an oven cleaner. Follow the package directions.



Do not spray oven cleaner on the electrical controls and switches because it could cause a short circuit and result in sparking or fire.

Do not allow a film from the cleaner to build up on the temperature sensor—it could cause the oven to heat improperly. (The sensor is located at the top of the oven.) Carefully wipe the sensor clean after each oven cleaning, being careful not to move the sensor as a change in its position could affect how the oven bakes.

Do not spray any oven cleaner on the oven door, handles or any exterior surface of the oven, cabinets or painted surfaces. The cleaner can damage these surfaces.

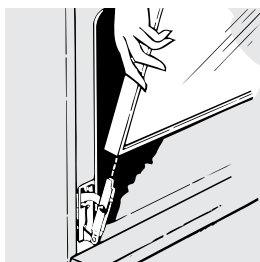

Lift the door straight up and off the hinges.

Lift-Off Oven Door

The oven door is removable for cleaning.

Do not lift the door by the handle. Make sure the oven is completely cool.

To remove the door, open it to the special stop position. Grasp firmly on each side and lift the door straight up and off the hinges.

Do not place hands between the hinge and the oven door frame.

To replace the door, make sure the hinges are in the special stop position. Position the slots in the bottom of the door squarely over the hinges and slowly lower it over both hinges.

To clean the inside of the door:

- Soap and water will normally do the job. Heavy spattering or spillovers may require cleaning with a mild abrasive cleaner. Soapy, wet metal pads may also be used.

Do not allow food spills with a high sugar or acid content (such as milk, tomatoes, sauerkraut, fruit juices or pie filling) to remain on the surface. They may cause a dull spot even after cleaning.

To clean the outside of the door:

- Use soap and water to thoroughly clean the top, sides and front of the oven door. Rinse well. You may also use a glass cleaner to clean the glass on the outside of the door. Do not let water drip into the vent openings.
- Spillage of marinades, fruit juices, tomato sauces and basting materials containing acids may cause discoloration and should be wiped up immediately. When surface is cool, clean and rinse.
- Do not use oven cleaners, cleaning powders or harsh abrasives on the outside of the door.

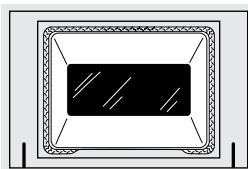

The gasket is designed with a gap at the bottom to allow for proper air circulation.

Because the area inside the gasket is cleaned during the self-clean cycle, you do not need to clean this by hand.

The area outside the gasket and the front frame can be cleaned with a soap-filled scouring pad, hot water and detergent. Rinse well with a vinegar and water solution.

Do not rub or clean the door gasket—it has an extremely low resistance to abrasion.

If you notice the gasket becoming worn, frayed or damaged in any way or if it has become displaced on the door, you should have it replaced.

Care and cleaning of the range.

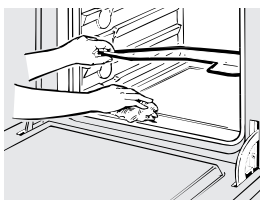

Oven Heating Elements

Do not clean the bake element or the broil element. Any soil will burn off when the elements are heated.

To clean the oven floor, gently lift the bake element. Clean with warm soapy water.



Oven Shelves

Clean the shelves with an abrasive cleanser or steel wool.

On self-cleaning models the oven shelves may be cleaned in the self-cleaning oven. However, the shelves will darken in color, lose their luster and become hard to slide if cleaned during the self-cleaning cycle.

To make the shelves slide more easily apply a small amount of vegetable oil or cooking oil to a paper towel and wipe the edges of the oven shelves with the paper towel.

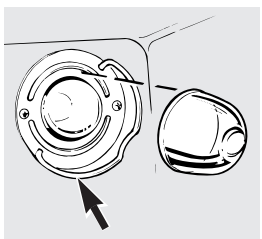

Wire cover holder

Oven Light Replacement *(on some models)*

CAUTION: Before replacing your oven light bulb, disconnect the electrical power to the range at the main fuse or circuit breaker panel.

Be sure to let the light cover and bulb cool completely.

To remove the cover:

- 1 Hold a hand under the cover so it doesn't fall when released. With fingers of the same hand, firmly push back the wire cover holder. Lift off the cover.

Do not remove any screws to remove the cover.

- 2 Replace bulb with a 40-watt household appliance bulb.

To replace the cover:

- 1 Place it into groove of the light receptacle. Pull wire forward to the center of the cover until it snaps into place.

- 2 Connect electrical power to the range.

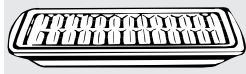

After broiling remove the broiler pan from the oven.

Broiler Pan & Grid

After broiling, remove the broiler pan from the oven. Remove the grid from the pan. Carefully pour out the grease from the pan into a proper container.

Wash and rinse the broiler pan and grid in hot water with a soap-filled or plastic scouring pad.

If food has burned on, sprinkle the grid with detergent while hot and cover with wet paper towels or a dishcloth. Soaking the pan will remove burned-on foods.

The broiler pan may be cleaned with a commercial oven cleaner. If the grid is grey enamel, it can also be cleaned with an oven cleaner. If the grid is chrome, do not use an oven cleaner to clean it.

Both the broiler pan and grid can also be cleaned in the dishwasher.

Do not store a soiled broiler pan and grid anywhere in the range.

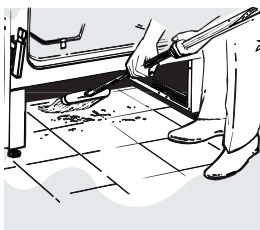

Clean under the range.

How to Remove the Storage Drawer to Clean Under the Range

To remove the storage drawer:

- 1 Pull the drawer out all the way.
- 2 Tilt up the front and remove it.

To replace the storage drawer:

- 1 Insert glides at the back of the drawer beyond the stop on range glides.
- 2 Lift the drawer if necessary to insert easily.
- 3 Let the front of the drawer down, then push in to close.

Cleaning the glass cooktop.

Clean the glass surface with cleaning cream before you use the cooktop for the first time. Also, clean the glass surface after each use. This helps protect the top and makes clean-up easier.

To clean the cooktop seal, let a wet cloth rest on it for a few minutes, then wipe clean. Use a mild detergent if needed.

Do not use a knife or any sharp object on the seal because it will cut or damage it.

Daily Cleaning

Use only a recommended cleaning cream, such as Cerama Brite or the Cooktop Cleaning Creme, on the glass cooktop.

To maintain and protect the surface of your new glass cooktop follow these steps.

Before you use the cooktop for the first time, clean it with cleaning cream. This helps protect the top and makes clean-up easier.

- Clean the surface with the cleaning cream after each use.
- Rub a few drops (less is better) of the cleaning cream onto soiled area using a damp paper towel. Buff with a dry paper towel until all soil and cream are removed.

For heavy, burned-on soil:

- 1 Apply a few drops of the cleaning cream to the (cool) soiled area.
- 2 Using a damp paper towel, rub the cream into the burned-on area. As with any burned-on spill, this may require some effort.
- 3 Carefully scrape soil with razor scraper. Hold scraper at a 30° angle against the glass cooktop.
- 4 If any soil remains, repeat the steps listed above. For additional protection, after all soil has been removed, polish the entire surface with the cleaning cream.
- 5 Buff with a dry paper towel.

To order more cream and/or scrapers for cleaning your glass cooktop, please call our toll-free number:

National Parts Center
800-626-2002

Cleaner # WX10X300
Scraper # WX5X1614
Cream & scraper kit ... # WB64X5027

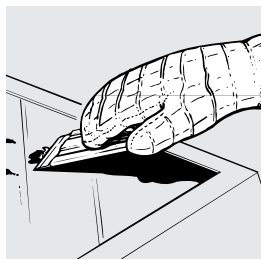

Using a razor scraper will not damage the surface if the 30° angle is maintained.

Special Care

Be sure to use a new sharp razor scraper. Do not use a dull or nicked blade.

Sugary spillovers (such as jellies, fudge, candy syrups) or melted plastics can cause pitting of the surface of your cooktop (not covered by the warranty) unless the spill is removed while still hot. Special care should be taken when removing hot substances.

- 1 Turn off all surface units affected by the spillover. Remove hot pans.
- 2 Wearing an oven mitt, hold the razor scraper at a 30° angle to the cooktop. Scrape the hot spill to a cool area outside the surface unit.
- 3 With the spill in a cool area, use a dry paper towel to remove any excess. Any spillover remaining should be left until the surface of the cooktop has cooled. Do not continue to use the soiled surface unit until all of the spillover has been removed. Follow the steps under *Heavy soil* to continue the cleaning process.

NOTE: *If pots with a thin overlay of aluminum, copper or enamel are allowed to boil dry, the overlay may bond with the glass cooktop and leave a black discoloration. This should be removed immediately before heating again or the discoloration may be permanent.*

Care and cleaning of the range.

Porcelain Enamel Cooktop (on some models)

The porcelain enamel finish is sturdy but breakable if misused. This finish is acid-resistant. However, any acidic foods spilled (such as fruit juices, tomato or vinegar) should not be permitted to remain on the finish.

If acids spill on the cooktop while it is hot, use a dry paper towel or cloth to wipe it up right away. When the surface has cooled, wash with soap and water. Rinse well.

For other spills such as fat splatterings, wash with soap and water or cleansing powders after the surface has cooled. Rinse well. Polish with a dry cloth.

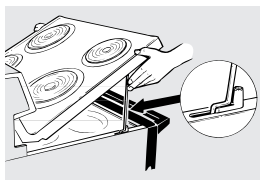

Be sure all surface units are turned off before raising the cooktop.

Lift-Up Cooktop (on some models)

Some models have a cooktop that can be lifted up for easier cleaning. The entire cooktop may be lifted up and supported in the up position.

The surface units do not need to be removed; however, you may remove one to make raising the cooktop easier. There are two side supports that lock into position when the cooktop is lifted up.

After cleaning under the cooktop with hot, mild soapy water and a clean cloth, lower the cooktop. Be careful not to pinch your fingers.

To lower the cooktop, push the rods back and gently lower the cooktop until it rests in place.

Be sure all the controls are turned to OFF and the surface units are cool before attempting to remove them.

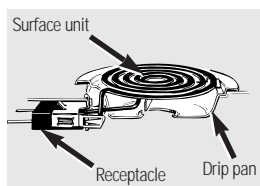

Surface Units (on some models)

To clean the surface units, turn the control to the highest setting for a minute. The coils will burn off any soil.

To remove a surface unit:

To remove the drip pans for cleaning, the surface units must be removed first.

Lift the surface unit about 1 inch above the drip pan and pull it out.

Do not lift the surface unit more than 1 inch. If you do, it may not lie flat on the drip pan when you plug it back in.

Repeated lifting of the surface unit more than 1 inch above the drip pan can permanently damage the receptacle.

To replace a surface unit:

Replace the drip pan into the recess in the cooktop. Make sure the opening in the pan lines up with the receptacle.

Insert the terminals of the surface unit through the opening in the drip pan and into the receptacle.

Guide the surface unit into place so it rests evenly.



Do not immerse the surface units in liquids of any kind.

Do not clean the surface units in a dishwasher.

Do not bend the surface unit plug terminals.

Do not attempt to clean, adjust or in any way repair the plug-in receptacle.

Drip Pans (on some models)

Remove the surface units. Then lift out the drip pans.

For best results, clean the drip pans by hand. Place them in a covered container (or a plastic bag) with 1/4 cup ammonia to loosen the soil. Then scrub with a soap-filled scouring pad if necessary. Rinse with clean water and polish with a clean soft cloth.

The drip pans may also be cleaned in the dishwasher.

Clean the area under the drip pans often. Built-up soil, especially grease, may catch fire.

Do not cover the drip pans with foil. Using foil so close to the receptacle could cause shock, fire or damage to the range.

Care and cleaning of the range.



If your range is removed for cleaning, servicing or any reason, be sure the anti-tip device is re-engaged properly when the range is replaced. Failure to take this precaution could result in tipping of the range and cause injury.

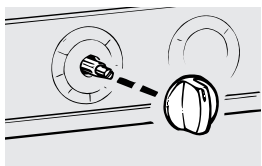

Pull the knob straight off the stem.

Control Panel and Knobs

Clean up spatters with a damp cloth. Remove heavier soil with warm, soapy water.

Do not use abrasives of any kind on the control panel.

The control knobs may be removed for easier cleaning. To remove a knob, pull it straight off the stem. Wash the knobs in soap and water but do not soak.

Oven Vent

On glass cooktop models, the oven is vented through an opening at the rear of the cooktop.

On coil cooktop models, the oven is vented through an opening under the right rear surface unit.

Never cover the opening with aluminum foil or any other material.

Painted Surfaces

Painted surfaces include the sides and the drawer front.

Clean these with soap and water or a vinegar and water solution.

Do not use commercial oven cleaners, cleaning powders, steel wool or harsh abrasives on any painted surface.

Glass Window *(on some models)*

To clean the outside glass finish, use a glass cleaner. Rinse and polish with a dry cloth.

Installation of the range.

Read these instructions completely and carefully.



Before You Begin

IMPORTANT: Save these instructions for the local electrical inspector's use.

IMPORTANT: OBSERVE ALL GOVERNING CODES AND ORDINANCES.

NOTE TO INSTALLER: Leave these instructions with the appliance after installation is completed.

NOTE TO CONSUMER: Keep this Owner's Manual and Installation Instructions for future use.

NOTE: This appliance must be properly grounded.



Tools You Will Need

- Large blade screwdriver
- 1/4" hex head nutdriver
- Channel lock pliers



Electrical Requirements

CAUTION, FOR PERSONAL SAFETY: DO NOT USE AN EXTENSION CORD WITH THIS APPLIANCE.

REMOVE HOUSE FUSE OR OPEN CIRCUIT BREAKER BEFORE BEGINNING INSTALLATION.

This appliance must be supplied with the proper voltage and frequency, and connected to an individual, properly grounded branch circuit, protected by a circuit breaker or time delay fuse, as noted on the rating plate.

Wiring must conform to National Electric Codes.

If the electric service provided does not meet the above specifications, have a licensed electrician install an approved outlet.

Because range terminals are not accessible after range is in position, flexible service conduit or cord must be used.

Installation of the range.

Read these instructions completely and carefully.

Prepare the Opening

Allow 1½" spacing from the range to adjacent vertical walls above cooktop surface.

Allow 30" minimum clearance between surface units and bottom of unprotected wood or metal top cabinet, and 15" minimum between countertop and adjacent cabinet bottom.

EXCEPTION: Installation of a listed microwave oven or cooking appliance over the cooktop shall conform to the installation instructions packed with that appliance.

If cabinet storage is installed, reduce risk by installing a range hood that projects horizontally a min. of 5" beyond the bottom of the cabinets. Make sure the wall covering, countertops and cabinets around the range can withstand heat generated by the range, oven or cooktop up to 200°F.

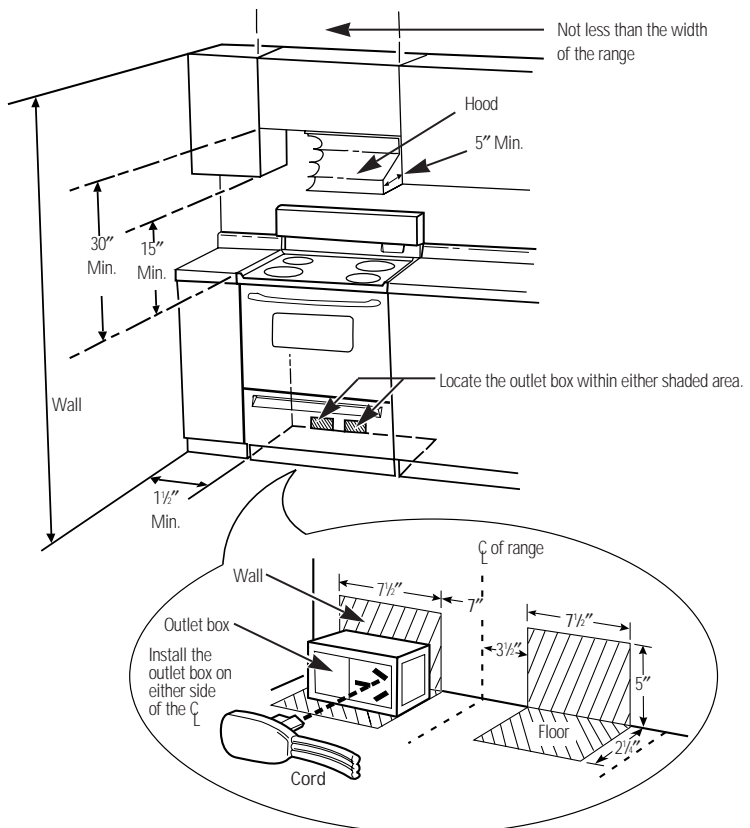

Read these instructions completely and carefully.

Flooring Under the Range

Your range, like many other household items, is heavy and can settle into soft floor coverings such as cushioned vinyl or carpeting.

When moving the range on this type of flooring, it should be installed on a 1/4" thick sheet of plywood (or similar material) as follows:

When the floor covering ends at the front of the range, the area that the range will rest on should be built up with plywood to the same level or higher than the floor covering. This will allow the range to be moved for cleaning or servicing.

Prepare for Electrical Connection

Effective January 1, 1996 the National Electric Code requires that new construction (not existing) utilize a 4-conductor connection to an electric range.

When installing an electric range in new construction follow Steps 3 and 5 for 4-wire connection.

Use only a 3-conductor or a 4-conductor UL-listed range cord. These cords may be provided with ring terminals on wire and a strain relief device.

A range cord rated at 40 amps with 125/250 minimum volt range is required. A 50 amp range cord is not recommended but if used, it should be marked for use with nominal 1 1/8" diameter connection openings. Care should be taken to center the cable and strain relief within the knockout hole to keep the edge from damaging the cable.

NOTE: A 4-conductor cord is to be used when the appliance is installed in a mobile home or when local codes do not permit grounding through the neutral. If conduit is being used, go to Step 6 or 7.

Installation of the range.

Read these instructions completely and carefully.

3 Power Cord Strain Relief Installation

- a Remove the lower rear range wiring cover to expose the connector block and bracket.
- b Remove the knockout ring (1 3/8") located on bracket directly below the connector. To remove the knockout, use a pair of pliers to bend the knockout ring away from the bracket and twist until ring is removed.

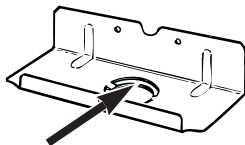

Knockout ring in bracket.

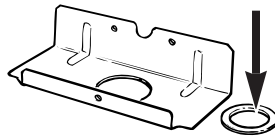

Knockout ring removed.

- c Assemble the strain relief in the hole. Insert the power cord through the strain relief and tighten. Allow enough slack to easily attach the cord terminals to the connector block. If tabs are present at the end of the winged strain relief, they can be removed for better fit.

NOTE: Do not install the power cord without a strain relief. The strain relief bracket should be installed before reinstalling the rear range wiring cover.

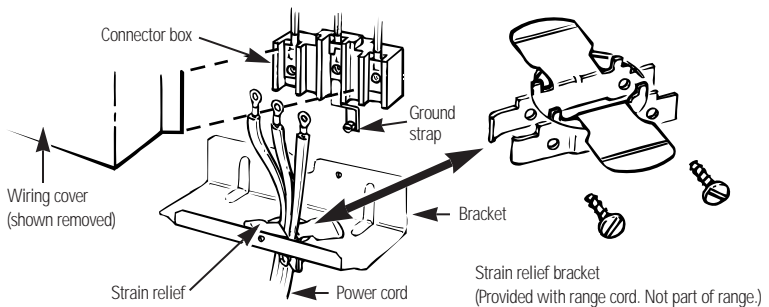

4 3-Wire Power Cord Installation

⚠ WARNING: *The neutral or ground wire of the power cord must be connected to the neutral terminal located in the center of the connector block. The power leads must be connected to the outside (brass colored) terminals.*

Remove the 3 wire terminal screws from the connector block. Insert screws through each power cord terminal ring and into the connector block until the screws engage the nuts. Be certain that the center wire is connected to the center screw of the connector block. Tighten screws securely.

Do NOT remove ground strap connection.

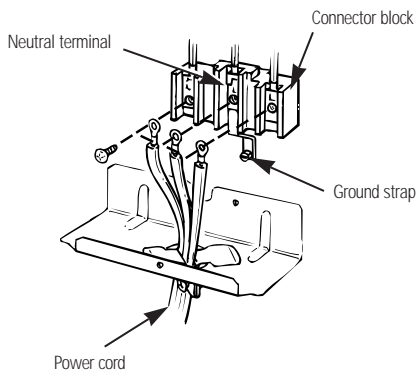





Installation of the range.

Read these instructions completely and carefully.

4-Wire Power Cord Installation

⚠ WARNING: The neutral wire of the supply circuit is connected to the neutral terminal located in the center of the connector block. The power leads must be connected to the outside (brass colored) terminals. The 4th grounding lead must be connected to the frame of the range with the grounding plate and grounding screw.

-  Remove the 3 screws from the connector block.
-  Remove the grounding screw and strap from the connector block middle location and the screw connection to the frame of the range.
-  Insert screws through each power cord terminal ring and into connector block until screw engages nut. Be certain that the center wire is connected to the center screw of the connector block. Tighten screws securely.
-  Attach ground wire to the frame of the range.

Before

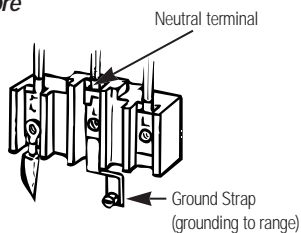

After

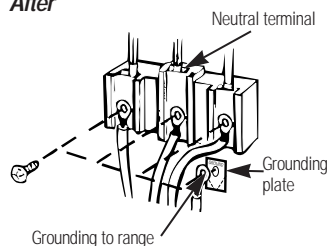

6 3-Wire Conduit Installation

Remove the 3 screws from the connector block. Insert bare wires between the connector block terminals and movable nuts. Tighten screws securely. Do not remove ground strap connection.

WARNING: Connector block is approved for copper wire connection only. If aluminum wire is used, see note below.

NOTE: ALUMINUM WIRING

Do not connect aluminum wire to the connector block.

Use copper building wire rated for the correct amperage and voltage to make 3 (three) 3" copper jumper wires. Connect wire as per Step 6 or 7 depending on number of wires.

Splice copper wires to aluminum wiring using special connector terminals designed and UL-approved for joining copper to aluminum and follow the connector manufacturer's recommended procedure closely.

Wire used, location and enclosure of splices, etc., must conform to good wiring practices and local codes.

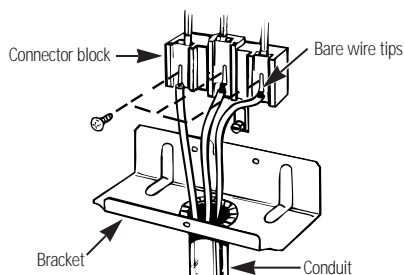
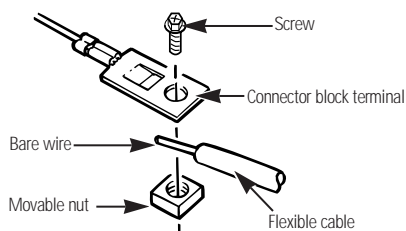

Installation of the range.

Read these instructions completely and carefully.

4-Wire Conduit Installation

Remove the 3 screws from the connector block. Remove the grounding strap from the connector block middle location and the screw connecting it to the frame of the range. Insert bare wires between the connector block terminals and movable nuts. Tighten screws securely. Attach ground wire to the frame of the range.

WARNING: Connector block is approved for copper wire connection only. If aluminum wire is used, see note below.

NOTE: ALUMINUM WIRING

Do not connect aluminum wire to connector block.

Use copper building wire rated for the correct amperage and voltage to make 3 (three) 3" copper jumper wires. Connect wire as per Step 6 or 7 depending on number of wires.

Splice copper wires to aluminum wiring using special connector terminals designed and UL-approved for joining copper to aluminum and follow the connector manufacturer's recommended procedure closely.

Wire used, location and enclosure of splices, etc., must conform to good wiring practices and local codes.

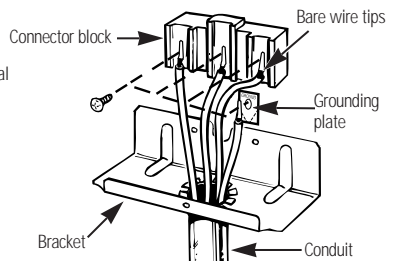
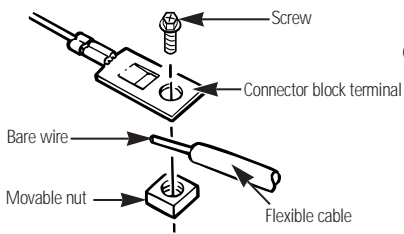

8 Anti-Tip Bracket Installation

An **Anti-Tip bracket** is supplied with instructions for installation in a variety of locations. The instructions include a template, a parts list and a list of tools necessary to complete the installation. Read the *Important Safety Information* and the instructions that fit your situation before beginning installation.

WARNING

- Range must be secured by **Anti-Tip bracket** supplied.
- See instructions to install (supplied with bracket).
- Unless properly installed, the range could be tipped by stepping or sitting on the door. Injury might result from spilled hot liquids or from the range itself.

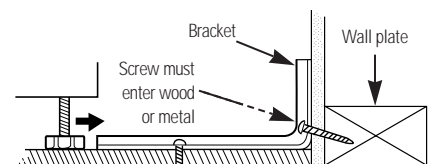

Typical installation of anti-tip bracket attachment to wall.

9 Leveling the Range

The range must be level. Leveling feet are located at each corner of the base of the range. Remove the storage drawer. Using channel locks, rotate the leveling feet in and out as required to level the range. (For instructions on how to remove and replace the storage drawer, see the *Care and cleaning of the range* section.)

On some models, there are plastic covers which may be removed for easy adjustment (just squeeze and pull).

One of the rear leveling feet will engage the **Anti-Tip bracket** (allow for some side to side adjustment). Allow a minimum clearance of 1/8" between the range and the leveling foot that is to be installed into the **Anti-Tip bracket**.

Check the range for proper installation into the **Anti-Tip bracket** by removing the storage drawer and inspecting the rear leveling leg. Make sure it fits securely into the slot.

10 Final Check

Be sure all range controls are in the **OFF** position before leaving the range.

Before you call for service...



Troubleshooting Tips

Save time and money! Review the charts on the following pages first and you may not need to call for service.

Problem	Possible Causes	What To Do
Glass Cooktops		
<i>Surface units will not maintain a rolling boil or cooking is not fast enough</i>	Improper cookware being used.	<ul style="list-style-type: none"> • Use pans which are absolutely flat and match the diameter of the surface unit selected.
<i>Surface units do not work properly</i>	A fuse in your home may be blown or the circuit breaker tripped.	<ul style="list-style-type: none"> • Replace fuse or reset circuit breaker.
	Cooktop controls improperly set.	<ul style="list-style-type: none"> • Check to see the correct control is set for the surface unit you are using.
<i>Tiny scratches (may appear as cracks) or abrasions on radiant cooktop glass surface</i>	Incorrect cleaning methods being used.	<ul style="list-style-type: none"> • Use recommended cleaning procedures.
	Cookware with rough bottoms being used or coarse particles (salt or sand) were between the cookware and the surface of the cooktop.	<ul style="list-style-type: none"> • Be sure cookware bottoms and cookware are clean before use. Use cookware with smooth bottoms. Tiny scratches are not removable but will become less visible in time as a result of cleaning.
	Cookware has been slid across the cooktop surface.	
<i>Areas of discoloration on the cooktop</i>	Improper cookware being used.	<ul style="list-style-type: none"> • Marks from aluminum and copper pans as well as mineral deposits from water or food can be removed with the cleaning cream.
<i>Hot sugar mixtures or plastic melted to the surface</i>	Hot cooktop came into contact with these substances.	<ul style="list-style-type: none"> • See the <i>Cleaning the glass cooktop</i> section.
<i>Frequent cycling off and on of surface units</i>	Improper cookware being used.	<ul style="list-style-type: none"> • Use only flat cookware to minimize cycling.

<i>Problem</i>	<i>Possible Causes</i>	<i>What To Do</i>
<i>Coil Cooktops</i>		
<i>Surface units not functioning properly</i>	The surface units are not plugged in solidly.	<ul style="list-style-type: none"> With the controls off, check to make sure the surface unit is plugged completely into the receptacle.
	The surface unit controls improperly set.	<ul style="list-style-type: none"> Check to see the correct control is set for the surface unit you are using.
	The drip pans are not set securely in the cooktop.	<ul style="list-style-type: none"> With the controls off, check to make sure the drip pan is in the recess in the cooktop and that the opening in the pan lines up with the receptacle.
<i>Oven—All Models</i>		
<i>Oven light does not work</i>	Light bulb is loose or defective.	<ul style="list-style-type: none"> Tighten or replace the bulb.
	Switch operating light is broken.	<ul style="list-style-type: none"> Call for service.
<i>Oven will not work</i>	Plug on range is not completely inserted in the electrical outlet.	<ul style="list-style-type: none"> Make sure electrical plug is plugged into a live, properly grounded outlet.
	A fuse in your home may be blown or the circuit breaker tripped.	<ul style="list-style-type: none"> Replace fuse or reset circuit breaker.
	Oven controls improperly set.	<ul style="list-style-type: none"> See the <i>Using the oven</i> section.
	On self-cleaning models, door left in the locked position.	<ul style="list-style-type: none"> If necessary, allow the oven to cool then unlock the door.

Before you call for service...



Troubleshooting Tips

Problem	Possible Causes	What To Do
Food does not bake or roast properly	Oven controls improperly set.	• See the <i>Using the oven</i> section.
	Shelf position is incorrect or the shelf is not level.	• See the <i>Using the oven</i> section.
	Incorrect cookware or cookware of improper size being used.	• See the <i>Using the oven</i> section.
	Oven thermostat needs adjustment.	• See the <i>Adjust the oven thermostat—Easy to do yourself!</i> section.
Food does not broil properly	Oven is not set at BROIL .	• Make sure you turn the knob all the way to the BROIL position.
	Door not open to the broil stop position as recommended.	• See the <i>Using the oven</i> section.
	Improper shelf position being used.	• See the <i>Broiling guide</i> .
	Food being cooked in a hot pan.	• Use the broiling pan and grid that came with your range. Make sure it is cool.
	Cookware not suited for broiling.	• Use the broiling pan and grid that came with your range.
	Aluminum foil used on the broiling pan and grid has not been fitted properly and slit as recommended.	• See the <i>Using the oven</i> section.
	In some areas the power (voltage) may be low.	• Preheat the broil element for 10 minutes. • Broil for the longest period of time recommended in the <i>Broiling guide</i> .

Problem	Possible Causes	What To Do
<i>Oven temperature too hot or too cold</i>	Oven thermostat needs adjustment.	<ul style="list-style-type: none"> • See the <i>Adjust the oven thermostat—Easy to do yourself!</i> section.
<i>Clock and timer do not work</i>	Plug on range is not completely inserted in the electrical outlet.	<ul style="list-style-type: none"> • Make sure electrical plug is plugged into a live, properly grounded outlet.
	A fuse in your home may be blown or the circuit breaker tripped.	<ul style="list-style-type: none"> • Replace fuse or reset circuit breaker.
	Oven controls improperly set.	<ul style="list-style-type: none"> • See the <i>Using the clock and timer</i> section.
<i>The display goes blank or indicator lights come on when range is not in use</i>	Power surge.	<ul style="list-style-type: none"> • Disconnect power at the fuse box or circuit breaker for at least 10 seconds. Turn power on and power up your range. If the indicator lights are still on, call for service.
<i>Oven door is crooked</i>	The door is out of position.	<ul style="list-style-type: none"> • Because the oven door is removable, it sometimes gets out of position during installation. To straighten the door, push down on the high corner.
<i>Oven makes clicking noise</i>	This is the sound of the heating element turning off and on during cooking functions.	<ul style="list-style-type: none"> • This is normal.

Before you call for service...



Troubleshooting Tips

<i>Problem</i>	<i>Possible Causes</i>	<i>What To Do</i>
<i>"F—and a number" flash in the display</i>	You have a function error code.	<ul style="list-style-type: none"> • Disconnect all power to the range for 5 minutes and then reconnect power. If the function error code repeats, call for service. • On self-cleaning models, if a function error code appears during the self-cleaning cycle, check the oven door latch. The latch may have been moved, even if only slightly, from the locked position. Make sure the latch is moved to the right as far as it will go. Turn the Oven Temperature knob to OFF. Allow the oven to cool for one hour. Put the oven back into operation.
<i>Power outage</i>	Power outage or surge.	<ul style="list-style-type: none"> • Some models will automatically resume their setting once the power is restored. On models with a clock, you must reset the clock. If the oven was in use, you must reset it by turning the Oven Temperature knob back to OFF, setting the clock and resetting any cooking function.

<i>Problem</i>	<i>Possible Causes</i>	<i>What To Do</i>
<i>Self-Cleaning Models</i>		
<i>Oven will not self-clean</i>	The oven temperature is too high to set a self-clean operation.	<ul style="list-style-type: none"> • Allow the range to cool to room temperature and reset the controls.
	Oven controls improperly set.	<ul style="list-style-type: none"> • Make sure you turn the control knob all the way to the CLEAN position.
	Oven door is not in the locked position.	<ul style="list-style-type: none"> • Make sure you move the door latch handle all the way to the right.
<i>Oven starts a self-clean cycle when you wanted to bake, roast or broil</i>	Oven door locked during cooking.	<ul style="list-style-type: none"> • Turn the Oven Temperature knob to OFF. Allow the oven to cool. Never force the door latch handle.
<i>“Crackling” or “popping” sound</i>	This is the sound of the metal heating and cooling during both the cooking and cleaning functions.	<ul style="list-style-type: none"> • This is normal.
<i>Excessive smoking</i>	Excessive soil.	<ul style="list-style-type: none"> • Turn the Oven Temperature knob to OFF. Open the windows to rid the room of smoke. Wait until the CLEAN light goes off. Wipe up the excess soil and reset the clean cycle.
<i>Oven door will not unlock</i>	Oven too hot.	<ul style="list-style-type: none"> • Allow the oven to cool below locking temperature.

Before you call for service...



Troubleshooting Tips

<i>Problem</i>	<i>Possible Causes</i>	<i>What To Do</i>
<i>CLEAN light is on when you want to cook</i>	The oven door was accidentally locked.	<ul style="list-style-type: none"> • Turn the Oven Temperature knob to OFF. Allow the oven to cool. Never force the door latch handle.
<i>Oven not clean after a clean cycle</i>	<p>Oven controls not properly set.</p> <p>Oven was heavily soiled.</p>	<ul style="list-style-type: none"> • See <i>Using the self-cleaning oven</i> section. • Clean up heavy spillovers before starting the clean cycle. Heavily soiled ovens may need to self-clean again or for a longer period of time.
<i>CLEAN light flashes</i>	Oven controls not properly set.	<ul style="list-style-type: none"> • Move the door latch handle to the right before setting the Oven Temperature knob to CLEAN.

Electric Range Warranty



All warranty service provided by our Factory Service Centers, or an authorized Customer Care® technician. For service, call 800-GE-CARES.

For The Period Of:	We Will Replace:
One Year From the date of the original purchase	Any part of the range which fails due to a defect in materials or workmanship. During this full one-year warranty , we will also provide, free of charge , all labor and in-home service to replace the defective part.
FOR MODELS JBP61 AND JBP63 ONLY:	
Two Years From the date of the original purchase	Any part of the range which fails due to a defect in materials or workmanship. During this full two-year warranty , we will also provide, free of charge , all labor and in-home service to replace the defective part.
Five Years From the date of the original purchase	A replacement glass cooktop if it should: crack due to thermal shock; discolor; crack at the rubber seal between the glass cooktop and the porcelain edge. It will also be replaced if the pattern wears off or if any of the radiant surface units burn out. During this five-year limited warranty , you will be responsible for any labor or in-home service costs.

What GE Will Not Cover:

- Service trips to your home to teach you how to use the product.
- Improper installation.
- Failure of the product if it is abused, misused, or used for other than the intended purpose or used commercially.
- Damage to the glass cooktop caused by use of cleaners other than the recommended cleaning creams.
- Replacement of house fuses or resetting of circuit breakers.
- Damage to the glass cooktop caused by hardened spills of sugary materials or melted plastic that are not cleaned according to the directions in the Owner's Manual.
- Damage to the product caused by accident, fire, floods or acts of God.
- Incidental or consequential damage to personal property caused by possible defects with this appliance.

This warranty is extended to the original purchaser and any succeeding owner for products purchased for home use within the USA. In Alaska, the warranty excludes the cost of shipping or service calls to your home.

Some states do not allow the exclusion or limitation of incidental or consequential damages. This warranty gives you specific legal rights, and you may also have other rights which vary from state to state. To know what your legal rights are, consult your local or state consumer affairs office or your state's Attorney General.

Warrantor: General Electric Company, Louisville, KY 40225

Download from www.Somanuals.com. All Manuals Search And Download.

Service Telephone Numbers.



GE Answer Center® 800.626.2000

The GE Answer Center® is open 24 hours a day, 7 days a week.



In-Home Repair Service 800-GE-CARES (800-432-2737)

Expert GE repair service is only a phone call away.



Special Needs Service 800.626.2000

TDD 800-TDD-GEAC (800-833-4322)

GE offers, free of charge, a brochure to assist in planning a barrier-free kitchen for persons with limited mobility.



Service Contracts 800-626-2224

Purchase a GE service contract while your warranty is still in effect and you'll receive a substantial discount. GE Consumer Service will still be there after your warranty expires.

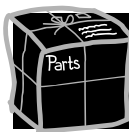

Parts and Accessories 800-626-2002

Individuals qualified to service their own appliances can have parts or accessories sent directly to their homes (VISA, MasterCard and Discover cards are accepted).

Instructions contained in this manual cover procedures to be performed by any user. Other servicing generally should be referred to qualified service personnel. Caution must be exercised, since improper servicing may cause unsafe operation.



Service Satisfaction

If you are not satisfied with the service you receive from GE, follow these three steps. **First**, contact the people who serviced your appliance. **Next**, if you are still not pleased, write all the details—including your phone number—to: Manager, Customer Relations, GE Appliances, Appliance Park, Louisville, KY 40225. **Finally**, if your problem is still not resolved, write:

Major Appliance Consumer Action Program
20 North Wacker Drive, Chicago, IL 60606.

Free Manuals Download Website

<http://myh66.com>

<http://usermanuals.us>

<http://www.somanuals.com>

<http://www.4manuals.cc>

<http://www.manual-lib.com>

<http://www.404manual.com>

<http://www.luxmanual.com>

<http://aubethermostatmanual.com>

Golf course search by state

<http://golfingnear.com>

Email search by domain

<http://emailbydomain.com>

Auto manuals search

<http://auto.somanuals.com>

TV manuals search

<http://tv.somanuals.com>