



Self-Cleaning Convection Ranges

Safety Information

Anti-Tip Device 3
 Safety Precautions 3, 4
 Radiant Surface Units 5
 Oven 6

Operating Instructions

Using the Surface Units 7-9
 Using the Oven 10-24
 Using the Clock and Timer ... 16
 Timed Baking & Roasting ... 17
 Oven Thermostat 24
 Self-Cleaning 25, 26

Care and Cleaning

Control Knobs 27
 Lift-Off Oven Door 28
 Oven Shelves 28
 Broiler Pan & Grid 29
 Oven Light 29
 Glass Cooktop 30

Troubleshooting Tips

Before You Call
 For Service 31-34

Customer Service

Product Registration 37, 38
 Warranty 39
 Service Telephone
 Numbers Back Cover

Owner's Manual

JB940

JB960

JBP85 



GE & You, A Service Partnership.

Safety Instructions



IMPORTANT!

Fill out the Consumer Product Registration Card.

Two easy ways to register your appliance!

- Through the internet at www.geappliances.com
- Complete and mail the enclosed Product Registration Card

Operating Instructions



FOR YOUR RECORDS

Write the model and serial numbers here:

You can find them on a label behind the storage drawer on the front of the range frame.

Staple sales slip or cancelled check here.

Proof of the original purchase date is needed to obtain service under the warranty.

Care and Cleaning



READ THIS MANUAL

Inside you will find many helpful hints on how to use and maintain your range properly. Just a little preventive care on your part can save you a great deal of time and money over the life of your range.

Troubleshooting Tips



IF YOU NEED SERVICE

You'll find many answers to common problems in the *Before You Call For Service* section. If you review our chart of *Troubleshooting Tips* first, you may not need to call for service at all.

If you do need service, you can relax knowing help is only a phone call away. A list of toll-free customer service numbers is included in the back section of this manual. Or you can always call the GE Answer Center® at 800.626.2000, 24 hours a day, 7 days a week.

Customer Service

IMPORTANT SAFETY INFORMATION. READ ALL INSTRUCTIONS BEFORE USING.

⚠ WARNING!

For your safety, the information in this manual must be followed to minimize the risk of fire, electric shock, or to prevent property damage, personal injury, or loss of life.



⚠ WARNING ANTI-TIP DEVICE

All ranges can tip and injury could result.

To prevent accidental tipping of the range, attach it to the wall and floor by installing the Anti-Tip device supplied.



To check if the device is installed and engaged properly, remove the kick panel or storage drawer and inspect the rear leveling leg. Make sure it fits securely into the slot.



If you pull the range out from the wall for any reason, make sure the device is properly engaged when you push the range back against the wall. If it is not, there is a possible risk of the range tipping over and causing injury if you or a child stand, sit or lean on an open door.

Please refer to the Anti-Tip device information in this manual. Failure to take this precaution could result in tipping of the range and injury.



IMPORTANT SAFETY NOTICE

The California Safe Drinking Water and Toxic Enforcement Act requires the Governor of California to publish a list of substances known to the state to cause cancer, birth defects or other reproductive harm, and requires businesses to warn customers of potential exposure to such substances.

The fiberglass insulation in self-clean ovens gives off a very small amount of carbon monoxide during the cleaning cycle. Exposure can be minimized by venting with an open window or using a ventilation fan or hood.



Fluorescent light bulbs contain mercury. If your model has a surface light, you must recycle the fluorescent light bulb according to local, state and federal codes.



SAFETY PRECAUTIONS

When using electrical appliances, basic safety precautions should be followed, including the following:

- Use this appliance only for its intended purpose as described in this Owner's Manual.
- Be sure your appliance is properly installed and grounded by a qualified installer in accordance with the provided installation instructions.
- Have the installer show you the location of the circuit breaker or fuse. Mark it for easy reference.
- Do not attempt to repair or replace any part of your range unless it is specifically recommended in this manual. All other servicing should be referred to a qualified technician.
- Before performing any service, disconnect the range power supply at the household distribution panel by removing the fuse or switching off the circuit breaker.
- Do not leave children alone—children should not be left alone or unattended in an area where an appliance is in use. They should never be allowed to sit or stand on any part of the appliance.
- Do not allow anyone to climb, stand or hang on the door, storage drawer or cooktop. They could damage the range and even tip it over, causing severe personal injury.

IMPORTANT SAFETY INFORMATION. READ ALL INSTRUCTIONS BEFORE USING.



⚠ WARNING! SAFETY PRECAUTIONS

Do not operate the oven or cooktop controls if the glass is broken. Food splatter or cleaning solution may penetrate a broken control panel and create a risk of electrical shock. Contact a qualified technician immediately should your glass control panel become broken.

- Do not store flammable materials in an oven or near the cooktop.
 - **CAUTION:** Items of interest to children should not be stored in cabinets above a range or on the backsplash of a range—children climbing on the range to reach items could be seriously injured.
 - Never wear loose-fitting or hanging garments while using the appliance. Be careful when reaching for items stored over the range. Flammable material could be ignited if brought in contact with hot surface units or heating elements and may cause severe burns.
 - Use only dry pot holders—moist or damp pot holders on hot surfaces may result in burns from steam. Do not let pot holders touch hot surface units or heating elements. Do not use a towel or other bulky cloth in place of pot holders.
 - Do not use water on grease fires. Never pick up a flaming pan. Turn the controls off. Smother a flaming pan on a surface unit by covering the pan completely with a well-fitting lid, cookie sheet or flat tray. Use a multi-purpose dry chemical or foam-type fire extinguisher.
- Flaming grease outside a pan can be put out by covering it with baking soda or, if available, by using a multi-purpose dry chemical or foam-type fire extinguisher.
- Flame in the oven can be smothered completely by closing the oven door and turning the oven off or by using a multi-purpose dry chemical or foam-type fire extinguisher.
- For your safety, never use your appliance for warming or heating the room.
 - Do not let cooking grease or other flammable materials accumulate in or near the range.
 - Do not touch the surface units, the heating elements or the interior surface of the oven. These surfaces may be hot enough to burn even though they are dark in color. During and after use, do not touch, or let clothing or other flammable materials contact the surface units, areas nearby the surface units or any interior area of the oven; allow sufficient time for cooling first.
- Potentially hot surfaces include the cooktop, areas facing the cooktop, oven vent opening, surfaces near the opening, crevices around the oven door.
- REMEMBER:** The inside surface of the oven may be hot when the door is opened.
- Do not store or use combustible materials, gasoline or other flammable vapors and liquids in the vicinity of this or any other appliance.
 - Keep the hood and grease filters clean to maintain good venting and to avoid grease fires.
 - Teach children not to play with the controls or any other part of the range.
 - Always keep dish towels, dish cloths, pot holders and other linens a safe distance from your range.
 - Always keep wooden and plastic utensils and canned food a safe distance from your range.
 - Always keep combustible wall coverings, curtains or drapes a safe distance from your range.



COOK MEAT AND POULTRY THOROUGHLY...

Cook meat and poultry thoroughly—meat to at least an INTERNAL temperature of 160°F. and poultry to at least an INTERNAL temperature of 180°F. Cooking to these temperatures usually protects against foodborne illness.



RADIANT SURFACE UNITS

Use proper pan size—select cookware having flat bottoms large enough to cover the surface unit heating element. The use of undersized cookware will expose a portion of the surface unit to direct contact and may result in ignition of clothing. Proper relationship of cookware to surface unit will also improve efficiency.

- Never leave the surface units unattended at high heat settings. Boilovers cause smoking and greasy spillovers that may catch on fire.
 - Only certain types of glass, glass/ceramic, earthenware or other glazed containers are suitable for cooktop service; others may break because of the sudden change in temperature.
 - To minimize the possibility of burns, ignition of flammable materials and spillage, the handle of a container should be turned toward the center of the range without extending over nearby surface units.
 - Always turn the surface units off before removing cookware.
 - When preparing flaming foods under the hood, turn the fan on.
 - Use care when touching the cooktop. The glass surface of the cooktop will retain heat after the controls have been turned off.
 - Keep an eye on foods being fried at high or medium high heat settings.
 - Foods for frying should be as dry as possible. Frost on frozen foods or moisture on fresh foods can cause hot fat to bubble up and over the sides of the pan.
 - Use little fat for effective shallow or deep fat frying. Filling the pan too full of fat can cause spillovers when food is added.
 - If a combination of oils or fats will be used in frying, stir together before heating, or as fats melt slowly.
 - Always heat fat slowly, and watch as it heats.
 - Use a deep fat thermometer whenever possible to prevent overheating fat beyond the smoking point.
 - Avoid scratching the glass cooktop. The cooktop can be scratched with items such as sharp instruments; rings or other jewelry, and rivets on clothing.
 - Do not operate the radiant surface units if the glass is broken. Spillovers or cleaning solution may penetrate a broken cooktop and create a risk of electrical shock. Contact a qualified technician immediately should your glass cooktop become broken.
 - Never use the glass cooktop surface as a cutting board.
 - Do not place or store items that can melt or catch fire on the glass cooktop, even when it is not being used.
 - Be careful when placing spoons or other stirring utensils on glass cooktop surface when it is in use. They may become hot and could cause burns.
 - Clean the cooktop with caution. If a wet sponge or cloth is used to wipe spills on a hot surface unit, be careful to avoid steam burns. Some cleaners can produce noxious fumes if applied to a hot surface.
- NOTE:** We recommend that you avoid wiping any surface unit areas until they have cooled and the indicator light has gone off. Sugar spills are the exception to this. Please see the *Cleaning the glass cooktop* section.
- When the cooktop is cool, use only the recommended cleaning cream to clean the cooktop.
 - To avoid possible damage to the cooking surface, do not apply cleaning cream to the glass surface when it is hot.
 - After cleaning, use a dry cloth or paper towel to remove all cleaning cream residue.
 - Read and follow all instructions and warnings on the cleaning cream labels.

IMPORTANT SAFETY INFORMATION. READ ALL INSTRUCTIONS BEFORE USING.



⚠ WARNING!

OVEN

Stand away from the range when opening the oven door. Hot air or steam which escapes can cause burns to hands, face and/or eyes.

- Do not heat unopened food containers. Pressure could build up and the container could burst, causing an injury.
- Keep the oven vent unobstructed.
- Keep the oven free from grease buildup.
- Place the oven shelf in the desired position while the oven is cool. If shelves must be handled when hot, do not let pot holder contact the heating elements.
- When using cooking or roasting bags in the oven, follow the manufacturer's directions.
- Pulling out the shelf to the stop-lock is a convenience in lifting heavy foods. It is also a precaution against burns from touching hot surfaces of the door or oven walls.
- Do not use the oven to dry newspapers. If overheated, they can catch on fire.
- Do not use the oven for a storage area. Items stored in an oven can ignite.
- Do not leave paper products, cooking utensils or food in the oven when not in use.
- Do not use aluminum foil to line oven bottoms, except as suggested in this manual. Improper installation of aluminum foil may result in a risk of electric shock or fire.



SELF-CLEANING OVEN

Do not use oven cleaners. No commercial oven cleaner or oven liner protective coating of any kind should be used in or around any part of the oven. Residue from oven cleaners will damage the inside of the oven when the self-clean cycle is used.

- Do not clean the door gasket. The door gasket is essential for a good seal. Care should be taken not to rub, damage or move the gasket.
- Before self-cleaning the oven, remove the broiler pan, grid and other cookware.
- Be sure to wipe up excess spillage before starting the self-cleaning operation.
- If the self-cleaning mode malfunctions, turn the oven off and disconnect the power supply. Have it serviced by a qualified technician.
- Clean only parts listed in this Owner's Manual.



Read and follow this Safety Information carefully.

SAVE THESE INSTRUCTIONS

Using the surface units.

Throughout this manual, features and appearance may vary from your model.

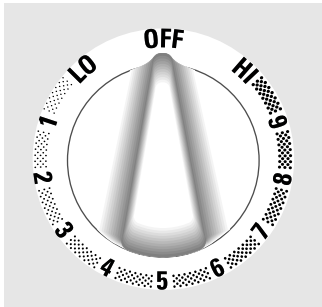

Be sure you turn the control knob to OFF when you finish cooking.

How to Set

Push the knob in and turn in either direction to the setting you want.

At both **OFF** and **HI** the control **clicks** into position. You may hear slight **clicking** sounds during cooking, indicating the control is keeping the power level you set.

A **HOT COOKTOP** indicator light will glow when any radiant element is turned on, and will remain on until the surface is cooled to approximately 150°F.

Indicator light will:

- come on when the unit is hot to the touch.
- stay on even after the unit is turned off.
- glow until the unit is cooled to approximately 150° F.

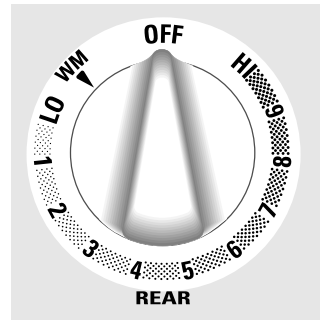

The **WM** (warm) setting on the right **REAR** surface unit keeps already heated food warm until ready to serve.

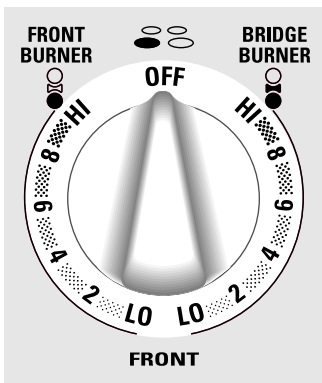

Using the Bridge Burner

To use the bridge burner, turn the control knob to the **BRIDGE BURNER** settings.

For full bridge burner operation, turn on the rear burner.

To use only the front burner, turn the control knob to the **FRONT BURNER** settings.

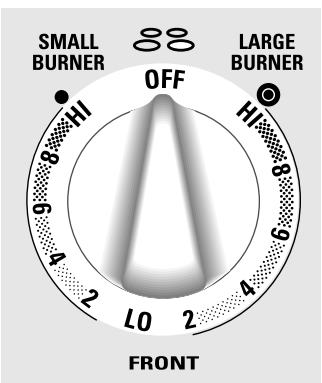
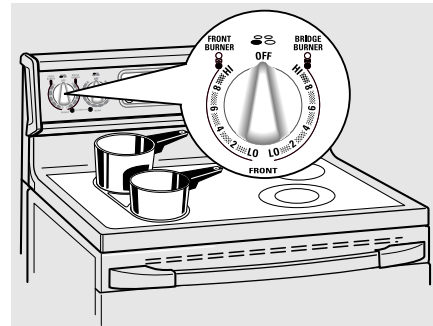

Dual Surface Unit Control Knob

The right front surface unit has 2 cooking sizes to select from so you can match the size of the unit to the size of the cookware you are using.

To use the small (6 inch) surface unit, turn the control knob to the **SMALL BURNER** settings.

To use the large (9 inch) surface unit, turn the control knob to the **LARGE BURNER** settings.

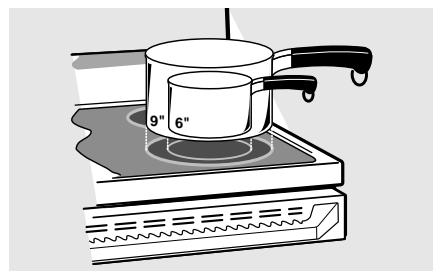

Using the surface units.



Never cook directly on the glass. Always use cookware.



Always place the pan in the center of the surface unit you are cooking on.

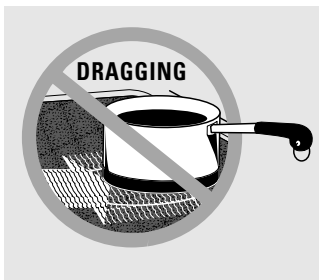

About the radiant surface units...

The radiant cooktop features heating units beneath a smooth glass surface.

NOTE: A slight odor is normal when a new cooktop is used for the first time. It is caused by the heating of new parts and insulating materials and will disappear in a short time.

NOTE: On some models with a white glass cooktop, it is normal for the surface to appear discolored when it is hot. This is temporary and will disappear as the glass cools.

The surface unit will cycle on and off to maintain your selected control setting.

It is safe to place hot cookware on the glass surface even when the cooktop is cool.

Even after the surface units are turned off, the glass cooktop retains enough heat to continue cooking. To avoid overcooking, remove pans from the surface units when the food is cooked. Avoid placing anything on the surface unit until it has cooled completely.

Do not slide cookware across the cooktop because it can scratch the glass—the glass is scratch resistant, not scratch proof.

- Water stains (mineral deposits) are removable using the cleaning cream or full strength white vinegar.
- Use of window cleaner may leave an iridescent film on the cooktop. The cleaning cream will remove this discoloration.
- Don't store heavy items above the cooktop. If they drop onto the cooktop, they can cause damage.
- Do not use the surface as a cutting board.

Temperature Limiter

Every radiant surface unit has a temperature limiter.

The temperature limiter protects the glass cooktop from getting too hot.

The temperature limiter may cycle the units off for a time if:

- The pan boils dry.
- The pan bottom is not flat.
- The pan is off center.
- There is no pan on the unit.

Selecting types of cookware.

The following information will help you choose cookware which will give good performance on glass cooktops.

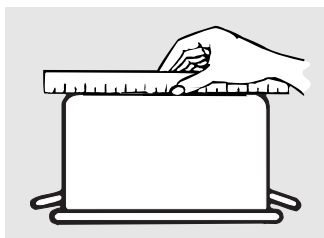

Check pans for flat bottoms by using a straight edge.

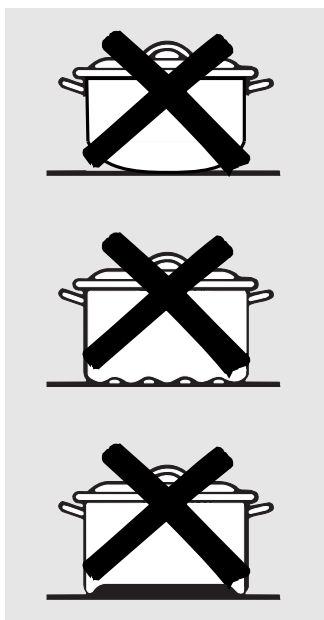

Pans with rounded, curved, ridged or warped bottoms are not recommended.

Stainless Steel:

recommended

Aluminum:

heavy weight recommended

Good conductivity. Aluminum residues sometimes appear as scratches on the cooktop, but can be removed if cleaned immediately. Because of its low melting point, thin weight aluminum should not be used.

Copper Bottom:

recommended

Copper may leave residues which can appear as scratches. The residues can be removed, as long as the cooktop is cleaned immediately. However, do not let these pots boil dry. Overheated metal can bond to glass cooktops. An overheated copper bottom pot will leave a residue that will permanently stain the cooktop if not removed immediately.

Porcelain Enamel Covered Cast Iron:

recommended

As long as the cookware is covered completely with porcelain enamel, this cookware is recommended. Caution is recommended for cast iron cookware that is not completely covered with smooth porcelain enamel, as it may scratch the glass ceramic cooktop.

Glass-ceramic:

usable, but not recommended

Poor performance. May scratch the surface.

Stoneware:

usable, but not recommended

Poor performance. May scratch the surface.

Home Canning Tips:

Be sure the canner is centered over the surface unit.

Make sure the canner is flat on the bottom.

Use recipes and procedures from reputable sources. These are available from manufacturers such as Ball® and Kerr® and the Department of Agriculture Extension Service.

To prevent burns from steam or heat, use caution when canning.

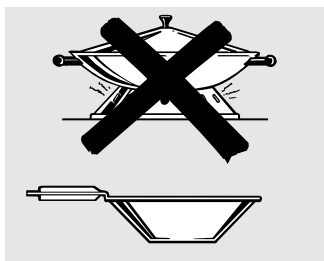

Use only flat-bottomed woks.

Wok Cooking

We recommend that you use only a flat-bottomed wok. They are available at your local retail store.

Do not use woks that have support rings.

Placing the ring over the surface unit will cause a build-up of heat that will damage the cooktop.

Do not use round bottom woks. You could be seriously burned if the wok tipped over.

Using the oven controls.

Throughout this manual, features and appearance may vary from your model.

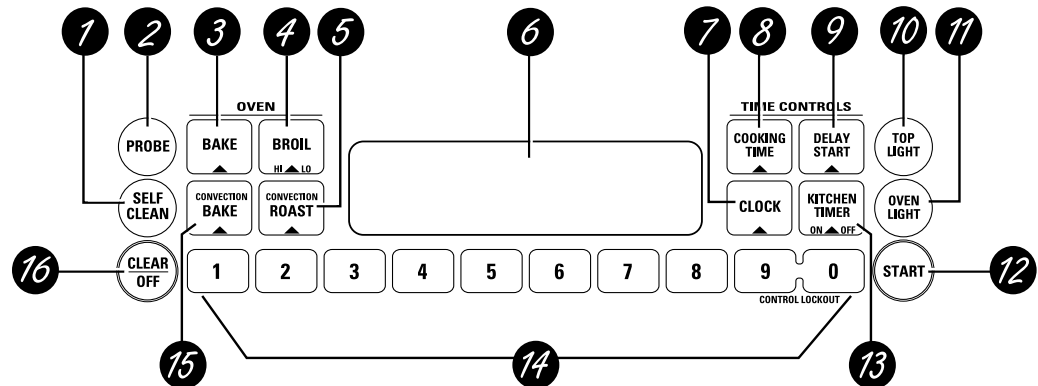

Oven Control, Clock and Timer Features and Settings

- 1 SELF CLEAN Pad**
Touch this pad to select the self-cleaning function. See the *Using the self-cleaning oven* section.
- 2 PROBE Pad (on some models)**
Touch this pad when using the probe to cook food to the desired internal temperature.
- 3 BAKE Pad**
Touch this pad to select the bake function.
- 4 BROIL HI/LO Pad**
Touch this pad to select the broil function.
- 5 CONVECTION ROAST Pad**
Touch this pad to select roasting with the convection function.
- 6 Display**
Shows the time of day, oven temperature, whether the oven is in the bake, broil or self-cleaning mode and the times set for the timer or automatic oven operations.
If "F—" and a number or letter" flash in the display and the oven control signals, this indicates a function error code.
If your oven was set for a timed oven operation and a power outage occurred, the clock and all programmed functions must be reset.
The time of day will flash in the display when there has been a power outage.
- 7 CLOCK Pad**
Touch this pad before setting the clock.
- 8 COOKING TIME Pad**
Touch this pad and then touch the number pads to set the amount of time you want your food to cook. The oven will shut off when the cooking time has run out.
- 9 DELAY START Pad**
Use along with **COOKING TIME** or **SELF CLEAN** pads to set the oven to start and stop automatically at a time you set.
- 10 TOP LIGHT Pad**
Touch this pad to turn the surface light on or off.
- 11 OVEN LIGHT Pad**
Touch this pad to turn the oven light on or off.
- 12 START Pad**
Must be touched to start any cooking or cleaning function.
- 13 KITCHEN TIMER ON/OFF Pad**
Touch this pad to select the timer feature.
- 14 Number Pads**
Use to set any function requiring numbers such as the time of day on the clock, the timer, the oven temperature, the internal food temperature, the start time and length of operation for timed baking and self-cleaning.
- 15 CONVECTION BAKE Pad**
Touch this pad to select baking with the convection function.
- 16 CLEAR/OFF Pad**
Touch this pad to cancel **ALL** oven operations except the clock and timer.

Special features of your oven control.

Your new touch pad control has additional features that you may choose to use. The following are the features and how you may activate them.

The special feature modes can only be activated while the display is showing the time of day. They remain in the control's memory until the steps are repeated.

When the display shows your choice, touch the **START** pad. The special features will remain in memory after a power failure.

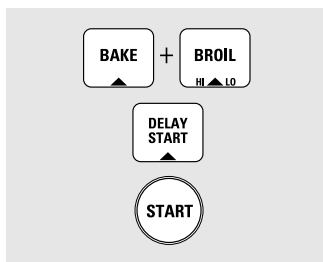

12 Hour Shut-Off

With this feature, should you forget and leave the oven on, the control will automatically turn off the oven after 12 hours during baking functions or after 3 hours during a broil function.

If you wish to turn **OFF** this feature, follow the steps below.

- 1 Touch the **BAKE** and **BROIL HI/LO** pads at the same time for 3 seconds until the display shows **SF**.
- 2 Touch the **DELAY START** pad. The display will show **12 shdn** (12 hour shut-off). Touch the **DELAY START** pad again and the display will show **no shdn** (no shut-off).
- 3 Touch the **START** pad to activate the no shut-off and leave the control set in this special features mode.

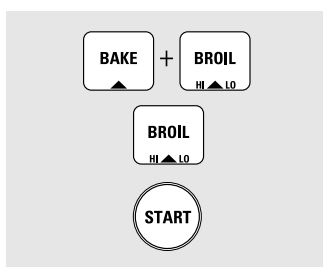

Fahrenheit or Celsius Temperature Selection

Your oven control is set to use the Fahrenheit temperature selections but you may change this to use the Celsius selections.

- 1 Touch the **BAKE** and **BROIL HI/LO** pads at the same time for 3 seconds until the display shows **SF**.
- 2 Touch the **BROIL HI/LO** pad. The display will show **F** (Fahrenheit).
- 3 Touch the **BROIL HI/LO** pad again. The display will show **C** (Celsius).
- 4 Touch the **START** pad.

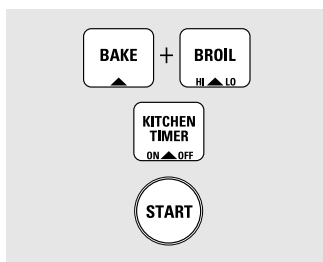

Tones at the End of a Timed Cycle

At the end of a timed cycle, 3 short beeps will sound followed by one beep every 6 seconds until the **CLEAR/OFF** pad is touched. This continual 6 second beep may be canceled.

To cancel the 6 second beep:

- 1 Touch the **BAKE** and **BROIL HI/LO** pads at the same time for 3 seconds until the display shows **SF**.
- 2 Touch the **KITCHEN TIMER ON/OFF** pad. The display shows **CON BEEP** (continual beep). Touch the **KITCHEN TIMER ON/OFF** pad again. The display shows **BEEP**. (This cancels the one beep every 6 seconds.)
- 3 Touch the **START** pad.

Special features of your oven control.



Control Lockout (on some models)

Your control will allow you to lock out the touch pads so they cannot be activated when touched or cleaning the glass panel.

To activate this feature:

- 1 Touch the **9** and **0** touch pads at the same time for 3 seconds until the control beeps twice. The display will show **LOC** continuously and the time of day if not blacked out.

NOTE: All cooking and timing functions will be cancelled when locking out the control.

- 2 To unlock the control, touch the **9** and **0** touch pads at the same time for 3 seconds until the control beeps twice, and **LOC** will be removed from the display.

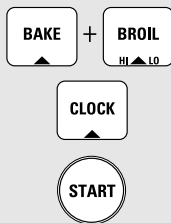

12 Hour, 24 Hour or Clock Black-Out

Your control is set to use a 12 hour clock.

If you would prefer to have a 24 hour military time clock or black-out the clock display, follow the steps below.

- 1 Touch the **BAKE** and **BROIL HI/LO** pads at the same time for 3 seconds until the display shows **SF**.
- 2 Touch the **CLOCK** pad once. The display will show **12 hr**. If this is the choice you want, touch the **START** pad.

Touch the **CLOCK** pad again to change to the 24 hour military time clock. The display will show **24 hr**. If this is the choice you want, touch the **START** pad.

Touch the **CLOCK** pad again to black-out the clock display. The display will show **OFF**. If this is the choice you want, touch the **START** pad.

NOTE: If the clock is in the black-out mode you will not be able to use the Delay Start function.

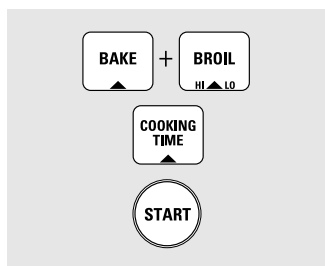

Cook and Hold

Your new control has a cook and hold feature that keeps cooked foods warm for up to 3 hours after the cooking function is finished.

To activate this feature, follow the steps below.

- 1 Touch the **BAKE** and **BROIL HI/LO** pads at the same time for 3 seconds until the display shows **SF**.
- 2 Touch the **COOKING TIME** pad. The display will show **Hid OFF**.
- 3 Touch the **START** pad to activate the cook and hold feature and leave the control set in this special features mode.

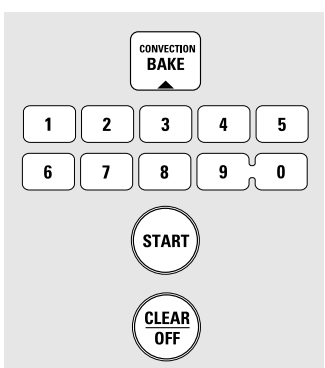

Using Convection Conversion

By using the Convection Conversion feature you can automatically convert the oven temperature from regular baking to Convection Bake temperatures.

To convert the oven temperature for convection baking, follow the steps below.

- 1 Touch and hold the **CONVECTION BAKE** pad for 4 to 5 seconds.
- 2 Using the number pads, enter the temperature recommended in the recipe.
- 3 Touch the **START** pad.
The display shows the converted (reduced) temperature. For example, if you entered a recipe temperature of 350°F., the display will show **325°F.** when it is converted.
- 4 Touch the **CLEAR/OFF** pad when baking is finished.

NOTE: Conversion must be set each time you want to use it. It is not held in memory.

Using the oven.

To avoid possible burns, place the shelves in the desired position before you turn the oven on.

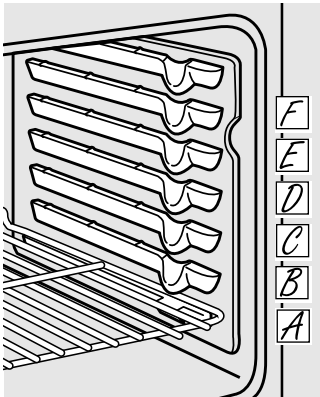

The oven has 6 shelf positions.

Before you begin...

The shelves have stops, so that when placed correctly on the supports, they will stop before coming completely out, and will not tilt.

When placing and removing cookware, pull the shelf out until it stops.

On some models, the bake heating element is under the oven floor. Do not place foods on the oven bottom for cooking.

To remove a shelf, pull it toward you, tilt the front end up and pull it out.

To replace, place the end of the shelf (stop-locks) on the support, tilt up the front and push the shelf in.

CAUTION: When you are using the shelf in the lowest position (A), you will need to use caution when pulling the shelf out. We recommend that you pull the shelf out several inches and then, using two pot holders, pull the shelf out by holding the sides of it. The shelf is low and you could be burned if you place your hand in the middle of the shelf and pull all the way out. Be very careful not to burn your hand on the door when using the shelf in the lowest position (A).

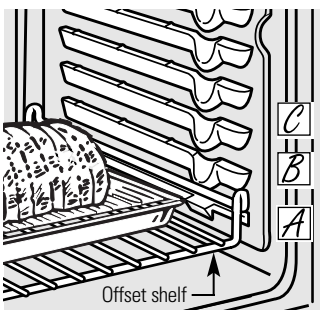

How to Set the Oven for Baking or Roasting

- 1 Touch the **BAKE** pad.
- 2 Touch the number pads to set the desired temperature.
- 3 Touch the **START** pad.
- 4 Check food for doneness at minimum time on recipe. Cook longer if necessary.
- 5 Touch the **CLEAR/OFF** pad when cooking is complete.

Type of Food	Shelf Position
Frozen pies (on cookie sheet)	D
Angel food cake, bundt or pound cakes	D
Biscuits, muffins, brownies, cookies, cupcakes, layer cakes, pies	C or D
Casseroles	C or D
Turkey or roast on offset shelf	A

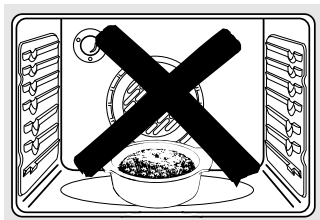

Do not place foods directly on the oven floor.

Preheating and Pan Placement

Preheat the oven if the recipe calls for it. Preheating is necessary for good results when baking cakes, cookies, pastry and breads.

To preheat, set the oven at the correct temperature. The control will beep when the oven is preheated and the display will show your set temperature. This will take approximately 15–20 minutes.

Baking results will be better if baking pans are centered in the oven as much as possible. If baking with more than one pan, place the pans so each has at least 1" to 1½" of air space around it. If baking four cake layers at the same time, place two layers on rack B and two layers on rack D. Stagger pans on the rack so one is not directly above the other.

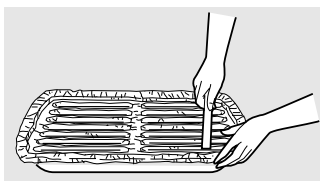

Cut slits in the foil just like the grid.

Aluminum Foil

You can use aluminum foil to line the broiler pan and broiler grid. However, you must mold the foil tightly to the grid and cut slits in it just like the grid.

Without the slits, the foil will prevent fat and meat juices from draining into the broiler pan. The juices could become hot enough to catch on fire. If you do not cut the slits, you are essentially frying, not broiling.

Do not use aluminum foil on the bottom of the oven.

Never entirely cover a shelf with aluminum foil. This will disturb the heat circulation and result in poor baking.

A smaller sheet of foil may be used to catch a spillover by placing it on a lower shelf several inches below the food.

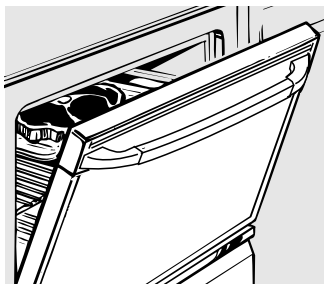

Leave the door open to the broil stop position. The door stays open by itself, yet the proper temperature is maintained in the oven.

How to Set the Oven for Broiling

- 1 Place the meat or fish on the broiler grid in the broiler pan.
- 2 Follow suggested shelf positions in the *Broiling Guide*.

If your range is connected to 208 volts, rare steaks may be broiled by preheating the broiler and positioning the oven shelf one position higher.

Use **LO Broil** to cook foods such as poultry or thick cuts of meat thoroughly without

over-browning them.

- 3 Touch the **BROIL HI/LO** pad once for **HI Broil**.

To change to **LO Broil**, touch the **BROIL HI/LO** pad again.

- 4 Touch the **START** pad.
- 5 When broiling is finished, touch the **CLEAR/OFF** pad.

Broiling Guide

Food	Quantity and/or Thickness	Shelf Position	First Side Time (min.)	Second Side Time (min.)	Comments
Ground Beef	1 lb. (4 patties) 1/2 to 3/4" thick 4 lbs. (12 patties)	D D	13 15	8 11	Space evenly.
Beef Steaks					
Rare†	3/4 to 1" thick	F	6	4	Steaks less than 3/4" thick are difficult to cook rare. Slash fat.
Medium	1 to 1 1/2 lbs.	E	8	6	
Well Done		E	10	8	
Rare†	1 1/2" thick	D	10	8	
Medium	2 to 2 1/2 lbs.	D	15	10-12	
Well Done		E	20	20	
Chicken					
	1 whole cut up 2 to 2 1/2 lbs., split lengthwise	C	25	25	Brush each side with melted butter. Broil skin-side-down first.
	Breast	C	25	15	
Bakery Product					
Bread (toast)	2 to 4 slices	E	3	1	Space evenly. Place English muffins cut-side-up and brush with butter if desired.
English Muffin	2 (split)	F	3-4		
Lobster Tails	2-4	C	18-20	Do not turn over.	Cut through back of shell. Spread open. Brush with melted butter before broiling and after half of broiling time.
Fish Fillets	1 lb. (1/4 to 1/2" thick)	E	5	5	Handle and turn very carefully. Brush with lemon butter before and during cooking, if desired.
Salmon Steaks	2 (1" thick)	E	10	5	Turn carefully. Do not turn skin side down.
Filletts	2 (1/2 to 3/4" thick)	E	10		
Ham Slices (precooked)	1/2" thick 1" thick	D D	6 8	6 8	
Pork Chops					
	2 (1/2" thick)	D	10	10	Slash fat.
	2 (1" thick) about 1 lb.	D	15	15	
Lamb Chops					
Medium	2 (1" thick) about 10	E	7	4	Slash fat.
Well Done	to 12 oz.	E	10	9	
Medium	2 (1 1/2" thick) about 1 lb.	E	9	6	
Well Done		E	14	10	

The size, weight, thickness, starting temperature, and your preference of doneness will affect broiling times. This guide is based on meats at refrigerator temperature.

† The U.S. Department of Agriculture says "Rare beef is popular, but you should know that cooking it to only 140° F. means some food poisoning organisms may survive." (Source: *Safe Food Book, Your Kitchen Guide*. USDA Rev. June 1985.)

Using the clock and timer.



Make sure the clock is set to the correct time of day.

To Set the Clock

The clock must be set to the correct time of day for the automatic oven timing functions to work properly. The time of day cannot be changed during a timed baking or self-cleaning cycle.

- 1 Touch the **CLOCK** pad.
- 2 Touch the number pads.
- 3 Touch the **START** pad until the time of day shows in the display.



The timer is a minute timer only.
The timer does not control oven operations. The maximum setting on the timer is 9 hours and 59 minutes.

To Set the Timer

- 1 Touch the **KITCHEN TIMER ON/OFF** pad.
- 2 Touch the number pads until the amount of time you want shows in the display. For example, to set 2 hours and 45 minutes, touch **2**, **4** and **5** in that order. If you make a mistake touch the **KITCHEN TIMER ON/OFF** pad and begin again.

- 3 Touch the **START** pad.
- 4 When the timer reaches **:00**, the control will beep 3 times followed by one beep every 6 seconds until the **KITCHEN TIMER ON/OFF** pad is touched.

The 6 second tone can be canceled by following the steps in the Special features of your oven control section under Tones at the End of a Timed Cycle.

To Reset the Timer

If the display is still showing the time remaining, you may change it by touching the **KITCHEN TIMER ON/OFF** pad, then touch the number pads until the time you want appears in the display.

If the remaining time is not in the display (clock, delay start or cooking time are in the display), recall the remaining time by touching the **KITCHEN TIMER ON/OFF** pad and then touching the number pads to enter the new time you want.

To Cancel the Timer

Touch the **KITCHEN TIMER ON/OFF** pad twice.

Using the timed baking and roasting features.

NOTE: Foods that spoil easily—such as milk, eggs, fish, stuffings, poultry and pork—should not be allowed to sit for more than 1 hour before or after cooking. Room temperature promotes the growth of harmful bacteria. Be sure that the oven light is off because heat from the bulb will speed harmful bacteria growth.

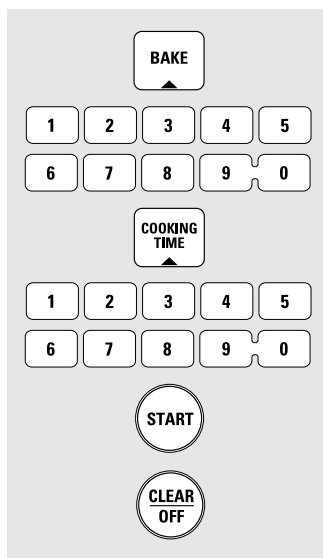

How to Set an Immediate Start and Automatic Stop

The oven will turn on immediately and cook for a selected length of time. At the end of the cooking time the oven will turn off automatically.

- 1 Touch the **BAKE** pad.
- 2 Using the number pads, enter the desired temperature.
- 3 Touch the **COOKING TIME** pad.

NOTE: If your recipe requires preheating, you may need to add additional time to the length of the cooking time.

- 4 Using the number pads, enter the desired baking time. The oven temperature and the cooking time that you entered will be displayed.
- 5 Touch the **START** pad.

The word **ON** and **100°** will be displayed. The cook time will begin to count down. As the oven heats up, the display will show the changing temperature. When the oven reaches the temperature you set, 3 beeps will sound.

At the end of timed baking, the oven will turn off. The end of cycle tone will sound.

Touch the **CLEAR/OFF** pad to clear the display.

How to Set a Delayed Start and Automatic Stop

You can set the oven control to delay-start the oven, cook for a specific length of time and then turn off automatically.

Make sure the clock shows the correct time of day.

- 1 Touch the **BAKE** pad.
- 2 Using the number pads, enter the desired temperature.
- 3 Touch the **COOKING TIME** pad.

NOTE: If your recipe requires preheating, you may need to add additional time to the length of the cooking time.

- 4 Using the number pads, enter the desired baking time.
- 5 Touch the **DELAY START** pad.
- 6 Using the number pads, enter the time of day you want the oven to turn on and start cooking.
- 7 Touch the **START** pad.

NOTE: An attention tone will sound if you are using timed baking and do not touch the **START** pad after entering the baking temperature.

If you would like to check the times you have set, touch the **DELAY START** pad to check the start time you have set or touch the **COOKING TIME** pad to check the length of cooking time you have set.

The oven will turn on automatically. The word **ON** and **100°** will be displayed. The cook time will begin to count down.

As the oven heats up, the display will show the changing temperature. The oven will cook for the programmed cooking time and shut off automatically.

At the end of timed baking, the oven will turn off. The end of cycle tone will sound.

Touch the **CLEAR/OFF** pad to clear the display.

Using the probe (on some models).

For many foods, especially roasts and poultry, internal food temperature is the best test for doneness. The temperature probe takes the guesswork out of roasting by cooking foods to the exact doneness you want.

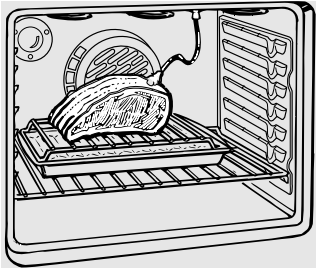

The temperature probe has a skewer-like probe at one end and a plug at the other end that goes into the outlet in the oven.

Use of probes other than the one provided with this product may result in damage to the probe.

Use the handles of the probe and plug when inserting and removing them from the food and outlet.

- To avoid damaging your probe, do not use tongs to pull on the cable when removing it.
- To avoid breaking the probe, make sure food is completely defrosted before inserting.
- To prevent possible burns, do not unplug the probe from the outlet until the oven has cooled.

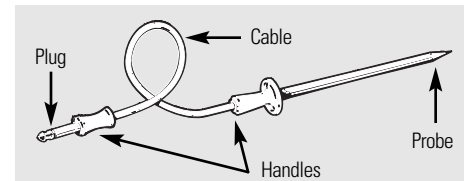

- Never leave your probe inside the oven during a self-cleaning cycle.
- Do not store the probe in the oven.

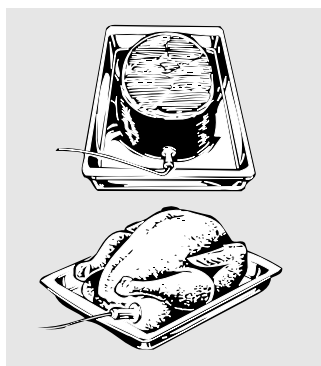

After preparing the meat and placing it on a trivet or on the broiler pan grid, follow these directions for proper probe placement.

Insert the probe completely into the meat. It should not touch the bone, fat or gristle.

For roasts with no bone, insert the probe into the meatiest part of the roast. For bone-in ham or lamb, insert the probe into the center of the lowest large muscle.

Insert the probe into the center of dishes such as meat loaf or casseroles.

Insert the probe into the meatiest part of the inner thigh from below and parallel to the leg of a whole turkey.

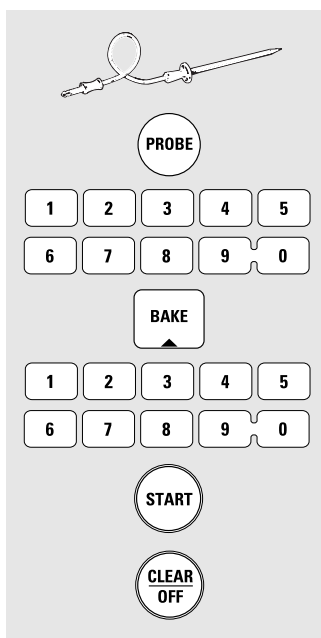

How to Set the Oven For Roasting When Using the Probe (on some models)

- 1 Insert the probe into the food.
- 2 Plug the probe into the outlet in the oven. Make sure it's pushed all the way in. Close the oven door. Make sure the probe cable is not touching the broil element.
- 3 Touch the **PROBE** pad.
- 4 Touch the number pads to set the desired internal food or meat temperature.
- 5 Touch the **BAKE** pad.
- 6 Touch the number pads to set the desired oven temperature.
- 7 Touch the **START** pad.

The display will flash if the probe is inserted into the outlet and you have not set a probe temperature and touched the **START** pad.

After the internal temperature of the food reaches 100°F., the changing

internal temperature will be shown in the display.

- 8 When the internal temperature of the food reaches the number you have set, the probe and the oven turn off and the oven control signals. To stop the signal, touch the **CLEAR/OFF** pad. Use hot pads to remove the probe from the food. Do not use tongs to pull on it—they might damage it.

To change the oven temperature during the Roast cycle, touch the **BAKE** pad and then the number pads to set the new temperature.

- If the probe is removed from the food before the final temperature is reached, a tone will sound and the display will flash until the probe is removed from the oven.
- You can use the timer even though you cannot use timed oven operations while using the probe.

Using the convection oven.

The convection oven fan shuts off when the oven door is opened. **DO NOT** leave the door open for long periods of time while using convection cooking or you may shorten the life of the convection heating element.

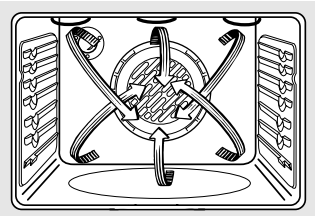

In a convection oven, a fan circulates hot air over, under and around the food. This circulating hot air is evenly distributed throughout the oven cavity. As a result, foods are evenly cooked and browned—often in less time than with regular heat.

To help you understand the difference between convection bake and roast and traditional bake and roast, here are some general guidelines.

Convection Bake

- Ideal for evenly browned baked foods cooked on multiple shelves.
- Good for large quantities of baked foods.
- Good results with cookies, biscuits, brownies, cupcakes, cream puffs, sweet rolls, angel food cake and bread.

Heat comes from the heating element in the rear of the oven. The convection fan circulates the heated air evenly over and around the food. Preheating is not necessary with foods having a bake time of over 15 minutes.

Convection Roast

- Good for large tender cuts of meat, uncovered.

Heat comes from the top heating element. The convection fan circulates the heated air evenly over and around the food. Meat and poultry are browned on all sides as if they were cooked on a rotisserie. Using the roasting rack provided, heated air will be circulated over, under and around the food being roasted. The heated air seals in juices quickly for a moist and tender product while, at the same time, creating a rich golden brown exterior.

Roasts or poultry should be cooked on the lowest shelf position (A) on a shelf.

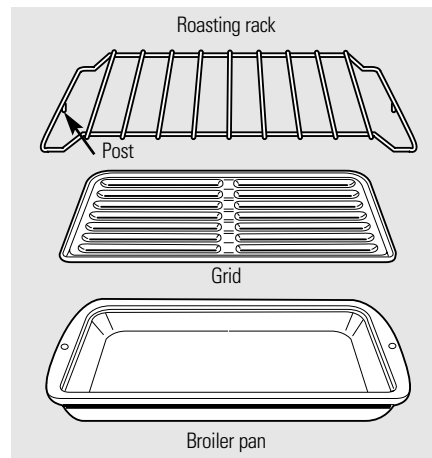

When you are convection roasting it is important that you use the broiler pan and grid and the special roasting rack for best convection roasting results. The pan is used to catch grease spills and the grid is used to prevent grease spatters. Place the meat on the special roasting rack. The rack allows the heated air to circulate under the meat and increase browning on the underside of the meat or poultry.

- Place the shelf in the lowest shelf position (A).
- Place the grid on the broiler pan and put the roasting rack over them making sure the posts on the roasting rack fit into the holes in the broiler pan.

Adapting Recipes...

You can use your favorite recipes in the convection oven.

When baking, reduce baking temperature by 25°F.

No need to preheat when cooking longer than 15 minutes.

- For more information on adapting recipes, see the Convection Cookbook. 
- Use pan size recommended.
- Some package instructions for frozen casseroles or main dishes have been developed using commercial convection ovens. For best results in this oven, preheat the oven and use the temperature on the package.

Using the convection oven.

Cookware for Convection Cooking

Before using your convection oven, check to see if your cookware leaves room for air circulation in the oven. If you are baking with several pans, leave space between them. Also, be sure the pans do not touch each other or the walls of the oven.

Paper and Plastic

Heat-resistant paper and plastic containers that are recommended for use in regular ovens can be used in convection ovens. Plastic cookware that is heat-resistant to temperatures of 400°F. can also be used, when oven is below 400°F.

Metal and Glass

Any type of cookware will work in your convection oven. However, metal pans heat the fastest and are recommended for convection baking.

■ *Darkened or matte-finished pans will bake faster than shiny pans.*

■ *Glass or ceramic pans cook more slowly.*

When baking cookies, you will get the best results if you use a flat cookie sheet instead of a pan with low sides.

For recipes like oven-baked chicken, use a pan with low sides. Hot air cannot circulate well around food in a pan with high sides.

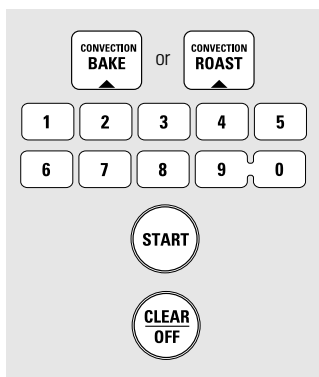

How to Set the Oven for Convection Baking or Roasting

- 1 Touch the **CONVECTION BAKE** or **CONVECTION ROAST** pad.
- 2 Touch the number pads to set the desired oven temperature.
- 3 Touch the **START** pad.

To change the oven temperature, touch the **CONVECTION BAKE** or **CONVECTION ROAST** pad and then the number pads to set the new temperature.

When the oven starts to heat the changing temperature, starting at 100°F., will be displayed. When the oven reaches the temperature you set, 3 beeps will sound.

- 4 Touch the **CLEAR/OFF** pad when finished.

NOTE: You will hear a fan while cooking with convection. The fan will stop when the door is opened but the heat will not turn off.

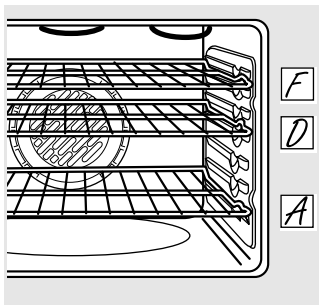

Multi-Shelf Baking

Because heated air is circulated evenly throughout the oven, foods can be baked with excellent results using multiple shelves.

Multi-shelf baking may increase cook times slightly for some foods but the overall result is time saved. Cookies, muffins, biscuits, and other quick breads give very good results with multi-shelf baking.

When baking on 3 shelves, place one shelf in the bottom (A) position, one on the 4th (D) position and the offset shelf in the 6th (F) position.

When convection baking with only 1 shelf, follow the shelf positions recommended in the Using the oven section.

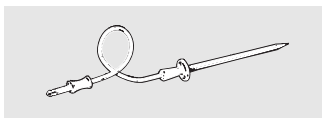

For best results when roasting large turkeys and roasts, we recommend using the probe included in the convection oven.

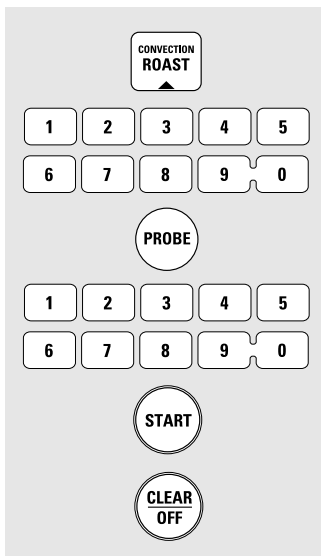

How to Set the Oven for Convection Roasting when Using the Probe (on some models)

The display will flash **PROBE** and the oven control will signal if the probe is inserted into the outlet, and you have not set a probe temperature and touched the **START** pad.

- 1 Place the shelf in the lowest position (A). Insert the probe into the food.
- 2 Plug the probe into the outlet in the oven. Make sure it is pushed all the way in. Close the oven door.
- 3 Touch the **CONVECTION ROAST** pad.
- 4 Touch the number pads to set the desired oven temperature.
- 5 Touch the **PROBE** pad.
- 6 Touch the number pads to set the desired internal food temperature.

To change the oven temperature during the Convection Roast cycle, touch the **CONVECTION ROAST** pad and then touch the number pads to set the new desired temperature.

- 7 Touch the **START** pad.

When the oven starts to heat, the word **LO** will be in the display.

After the internal temperature of the food reaches 100°F., the changing internal temperature will be shown in the display.

- 8 When the internal temperature of the food reaches the number you have set, the probe and the oven turn off and the oven control signals. To stop the signal, touch the **CLEAR/OFF** pad. Use hot pads to remove the probe from the food. Do not use tongs to pull on it—they might damage it.

CAUTION: To prevent possible burns, do not unplug the probe from the oven outlet until the oven has cooled. Do not store the probe in the oven.

NOTE:

- If the probe is removed from the food before the final temperature is reached, a tone will sound and the display will flash until the probe is removed from the oven.
- You will hear a fan while cooking with this feature. The fan will stop when the door is opened but the heat will not turn off.
- You can use the timer even though you cannot use timed oven operations while using the probe.

Using the convection oven.

Convection Roasting Guide

Meats		Minutes/Lb.	Oven Temp.	Internal Temp.		
Beef	Rib (3 to 5 lbs.)	Rare†	20–24	325°F.	140°F.	
		Medium	24–28	325°F.	160°F.	
		Well	28–32	325°F.	170°F.	
	Boneless Rib, Top Sirloin	Rare†	20–24	325°F.	140°F.	
		Medium	24–28	325°F.	160°F.	
Well		28–32	325°F.	170°F.		
Beef Tenderloin	Rare†	10–14	325°F.	140°F.		
	Medium	14–18	325°F.	160°F.		
	Pot Roast (2 ½ to 3 lbs.) chuck, rump	35–45	300°F.	170°F.		
Pork	Bone-in (3 to 5 lbs.)		23–27	325°F.	170°F.	
	Boneless (3 to 5 lbs.)		23–27	325°F.	170°F.	
	Pork Chops (½ to 1" thick)	2 chops	30–35 total	325°F.	170°F.	
		4 chops	35–40 total	325°F.	170°F.	
6 chops		40–45 total	325°F.	170°F.		
Ham	Canned (3 lbs. fully cooked)		14–18	325°F.	140°F.	
	Butt (5 lbs. fully cooked)		14–18	325°F.	140°F.	
	Shank (5 lbs. fully cooked)		14–18	325°F.	140°F.	
Lamb	Bone-in (3 to 5 lbs.)	Medium	17–20	325°F.	160°F.	
		Well	20–24	325°F.	170°F.	
	Boneless (3 to 5 lbs.)	Medium	17–20	325°F.	160°F.	
		Well	20–24	325°F.	170°F.	
Seafood	Fish, whole (3 to 5 lbs.)		30–40 total	400°F.		
	Lobster Tails (6 to 8 oz. each)		20–25 total	350°F.		
Poultry	Whole Chicken (2 ½ to 3 ½ lbs.)		24–26	350°F.	180°–185°F.	
	Cornish Hens Unstuffed (1 to 1½ lbs.)		50–55 total	350°F.	180°–185°F.	
	Cornish Hens Stuffed (1 to 1½ lbs.)		55–60 total	350°F.	180°–185°F.	
	Duckling (4 to 5 lbs.)		24–26	325°F.	180°–185°F.	
	Turkey, whole*	Unstuffed (10 to 16 lbs.)		8–11	325°F.	180°–185°F.
		Unstuffed (18 to 24 lbs.)		7–10	325°F.	180°–185°F.
	Turkey Breast (4 to 6 lbs.)		16–19	325°F.	170°F.	

* Stuffed birds generally require 30–45 minutes additional roasting time. Shield legs and breast with foil to prevent over-browning and drying of skin.

† The U.S. Department of Agriculture says "Rare beef is popular, but you should know that cooking it to only 140° F. means some food poisoning organisms may survive." (Source: *Safe Food Book. Your Kitchen Guide*. USDA Rev. June 1985.)

Using the timed features for convection baking.

You will hear a fan while cooking with this feature. The fan will stop when the door is opened but the heat will not turn off.

NOTE: Foods that spoil easily—such as milk, eggs, fish, stuffings, poultry and pork—should not be allowed to sit for more than 1 hour before or after cooking. Room temperature promotes the growth of harmful bacteria. Be sure that the oven light is off because heat from the bulb will speed harmful bacteria growth.

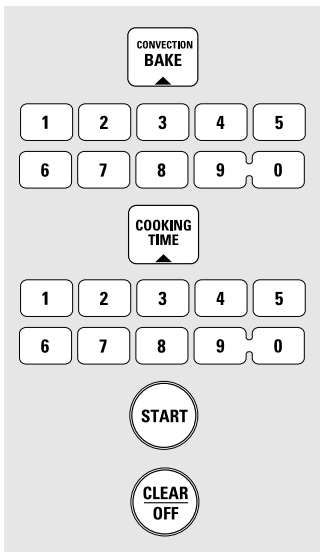

How to Set an Immediate Start and Automatic Stop

The oven will turn on immediately and cook for a selected length of time. At the end of the cooking time the oven will turn off automatically.

- 1 Touch the **CONVECTION BAKE** pad.
- 2 Touch the number pads to set the desired oven temperature.
- 3 Touch the **COOKING TIME** pad.

NOTE: If your recipe requires preheating, you may need to add additional time to the length of the cooking time.

- 4 Touch the number pads to set the desired length of cooking time. The minimum cooking time you can set is 1 minute.

The oven temperature that you set and the cooking time that you entered will be in the display.

- 5 Touch the **START** pad.

The display shows the oven temperature that you set and the cooking time countdown. The display starts changing once the temperature reaches 100°F.

- 6 At the end of timed convection bake the oven will turn off. The end of cycle tone will sound. Touch the **CLEAR/OFF** pad to clear the display if necessary.
- 7 Remove the food from the oven. Remember, foods that are left in the oven continue cooking after the controls are off.

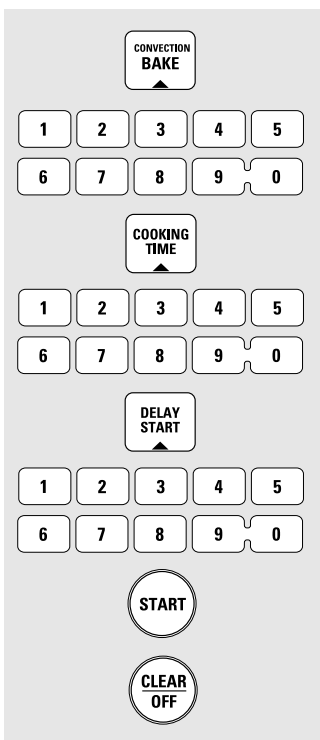

How to Set a Delayed Start and Automatic Stop

You can set the oven control to delay-start the oven, cook for a specific length of time and then turn off automatically.

Make sure the clock shows the correct time of day.

- 1 Touch the **CONVECTION BAKE** pad.
- 2 Touch the number pads to set the desired oven temperature.
- 3 Touch the **COOKING TIME** pad.

NOTE: If your recipe requires preheating, you may need to add additional time to the length of the cooking time.

- 4 Touch the number pads to set the desired cooking time.
- 5 Touch the **DELAY START** pad.
- 6 Touch the number pads to set the time of day you want the oven to turn on and start cooking.

If you would like to check the times you have set, touch the **DELAY START** pad to check the start time you have set or touch the **COOKING TIME** pad to check the length of cooking time you have set.

- 7 Touch the **START** pad.

NOTE: An attention tone will sound if you are using timed baking and do not touch the **START** pad after entering the baking temperature.

When the oven turns on at the time of day you have set, the display will show the changing temperature (starting at 100°F.) and the cooking time countdown.

At the end of timed convection bake the oven will turn off. The end of cycle tone will sound.

- 8 Touch the **CLEAR/OFF** pad to clear the display if necessary. When baking is finished, remove the food from the oven. Remember, even though the oven shuts off automatically, foods continue cooking after the controls are off.

Adjust the oven thermostat—Do it yourself!

You may find that your new oven cooks differently than the one it replaced. Use your new oven for a few weeks to become more familiar with it. If you still think your new oven is too hot or too cold, you can adjust the thermostat yourself.

Do not use thermometers, such as those found in grocery stores, to check the temperature setting of your oven. These thermometers may vary 20–40 degrees.

NOTE: This adjustment will not affect the broiling or the self-cleaning temperatures. The adjustment will be retained in memory after a power failure.

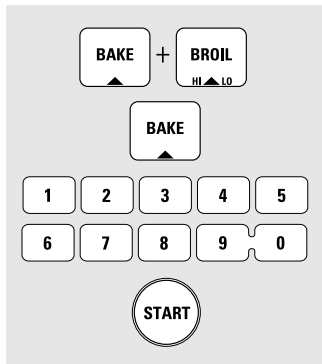

To Adjust the Thermostat

- 1 Touch the **BAKE** and **BROIL HI/LO** pads at the same time for 3 seconds until the display shows **SF**.
- 2 Touch the **BAKE** pad. A two digit number shows in the display.
Touch **BAKE** once to decrease (-) the oven temperature, or twice to increase (+).
- 3 The oven temperature can be adjusted up as much as 35°F. or down as much as 35°F. Touch the number pads the same way you read them. For example, to change the oven temperature 15°F., touch **1** and **5**.

- 4 When you have made the adjustment, touch the **START** pad to go back to the time of day display. Use your oven as you would normally.

NOTE: The thermostat adjustment for Baking will also affect Convection Baking or Convection Roasting.

The type of margarine will affect baking performance!

Most recipes for baking have been developed using high fat products such as butter or margarine (80% fat). If you decrease the fat, the recipe may not give the same results as with a higher fat product.

Recipe failure can result if cakes, pies, pastries, cookies or candies are made with low fat spreads. The lower the fat content of a spread product, the more noticeable these differences become.

Federal standards require products labeled “margarine” to contain at least 80% fat by weight. Low fat spreads, on the other hand, contain less fat and more water. The high moisture content of these spreads affects the texture and flavor of baked goods. For best results with your old favorite recipes, use margarine, butter or stick spreads containing at least 70% vegetable oil.

Using the self-cleaning oven.

The oven door must be closed and all controls set correctly for the cycle to work properly.

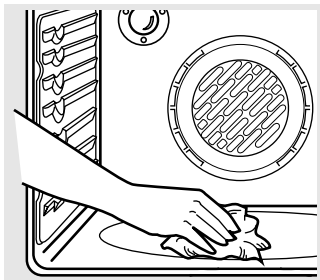

Wipe up heavy soil on the oven bottom.

Before a Clean Cycle

We recommend venting your kitchen with an open window or using a ventilation fan or hood during the first self-clean cycle.

Remove the shelves, broiler pan, broiler grid, probe, all cookware and any aluminum foil from the oven.

The oven shelves and convection roasting rack can be self-cleaned, but they will darken, lose their luster and become hard to slide.

Soil on the front frame of the range and outside the gasket on the door will need to be cleaned by hand. Clean these areas with hot water, soap-filled steel-wool pads or cleansers such as Soft Scrub®. Rinse well with clean water and dry.

Do not clean the gasket. The fiberglass material of the oven door gasket cannot withstand abrasion. It is essential for the gasket to remain intact. If you notice it becoming worn or frayed, replace it.

Wipe up any heavy spillovers on the oven bottom.

Make sure the oven light bulb cover is in place and the oven light is off.

IMPORTANT: The health of some birds is extremely sensitive to the fumes given off during the self-cleaning cycle of any range. Move birds to another well ventilated room.

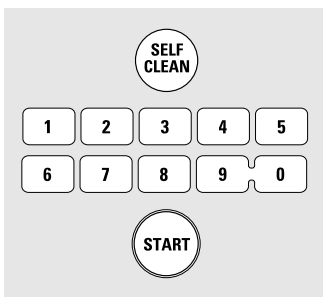

How to Set the Oven for Cleaning

- 1 Touch the **SELF CLEAN** pad.
- 2 Using the number pads, enter the desired clean time, if a time other than 4 hours, 30 minutes is needed.

Clean cycle time is normally 4 hours, 30 minutes. You can change the clean time to any time between 3 hours and 5 hours, depending on how dirty your oven is.

- 3 Touch the **START** pad.

The door locks automatically. The display will show the clean time remaining. It will not be possible to open the oven door until the temperature drops below the lock temperature and the **LOCKED DOOR** light goes off.

When the **LOCKED DOOR** light is off, open the door.

The oven shuts off automatically when the clean cycle is complete.

- The words **LOCK DOOR** will flash and the oven control will signal if you set the clean cycle and forget to close the oven door.
- To stop a clean cycle, touch the **CLEAR/OFF** pad. When the **LOCKED DOOR** light goes off indicating the oven has cooled below the locking temperature, open the door.

Using the self-cleaning oven.

The oven door must be closed and all controls set correctly for the cycle to work properly.

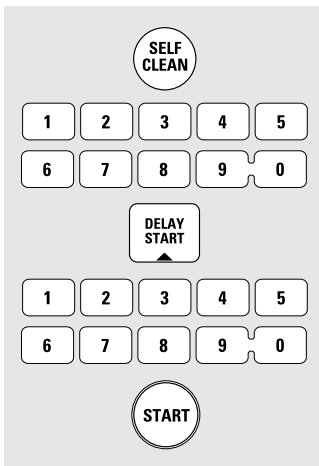

How to Delay the Start of Cleaning

Make sure the clock shows the correct time of day.

- 1 Touch the **SELF CLEAN** pad.
- 2 Using the number pads, enter the desired clean time.
- 3 Touch the **DELAY START** pad. The earliest start time you can set will appear in the display.
- 4 Using the number pads, enter the time of day you want the clean cycle to start.

- 5 Touch the **START** pad.

The door locks automatically. The display will show the start time. It will not be possible to open the oven door until the temperature drops below the lock temperature and the **LOCKED DOOR** light goes off.

When the **LOCKED DOOR** light is off, open the door.

After a Clean Cycle

You may notice some white ash in the oven. Wipe it up with a damp cloth after the oven cools.

If white spots remain, remove them with a soap-filled steel wool pad and rinse thoroughly with a vinegar and water mixture.

These deposits are usually a salt residue that cannot be removed by the clean cycle.

If the oven is not clean after one clean cycle, repeat the cycle.

- You cannot set the oven for cooking until the oven is cool enough for the door to unlock.
- While the oven is self-cleaning, you can touch the **CLOCK** pad to display the time of day. To return to the clean countdown, touch the **COOKING TIME** pad.
- If the shelves become hard to slide, apply a small amount of vegetable oil or cooking oil to a paper towel and wipe the edges of the oven shelves with the paper towel.

Care and cleaning of the range.

Be sure all controls are off and all surfaces are cool before cleaning any part of the range.

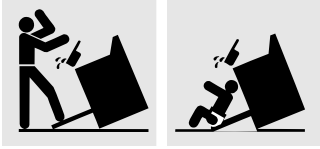

If your range is removed for cleaning, servicing or any reason, be sure the anti-tip device is re-engaged properly when the range is replaced. Failure to take this precaution could result in tipping of the range and cause injury.

How to Remove Packaging Tape

To assure no damage is done to the finish of the product, the safest way to remove the adhesive left from packaging tape on new appliances is an application of a household liquid dishwashing detergent, mineral oil or cooking oil.

Apply with a soft cloth and allow to soak. Wipe dry and then apply an appliance polish to thoroughly clean and protect the surface.

NOTE: The plastic tape (on some models) must be removed from all chrome trim. It cannot be removed if it is baked on.

Control Knobs

The control knobs may be removed for easier cleaning.

check the **OFF** position to insure proper placement.

Before removing the knobs for cleaning, please note that the knobs are in the **OFF** position. When replacing the knobs,

Wash the knobs in soap and water or a vinegar and hot water solution but do not soak.

Groove Stem

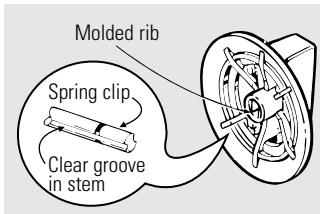

The knob stem has a groove in each side. The groove on one side has a spring clip. The other groove is clear (see illustration). Check the inside of the knob and find the molded rib.

Replace the knob by fitting the molded rib inside the knob into the clear groove on the stem.

Flat Stem

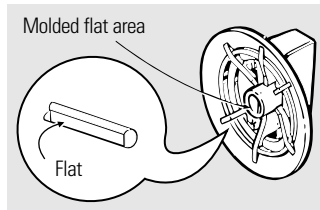

The knob stem is flat on one side (see illustration). Check the inside of the knob and find the molded flat area.

Replace the knob by fitting the molded flat area inside the knob onto the flat area of the stem.

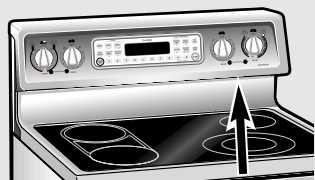

Oven Vent

The oven vent is located behind the right rear surface unit.

It is normal for steam to come out of the vent and moisture may collect underneath it when the oven is in use.

This area could become hot during oven use.

The vent is important for proper air circulation. Never block this vent.

Control Panel

Deactivate the touch pads before cleaning.

Remove heavier soil with warm soapy water. Do not use abrasives of any kind.

See the *Cooking/Self-Clean lockout* information in the *Special features of your oven control* section in this manual.

Reactivate the touch pads after cleaning.

Clean up splatters with a damp cloth.

See the *Cooking/Self-Clean lockout* information in the *Special features of your oven control* section in this manual.

You may also use a glass cleaner.

Care and cleaning of the range.

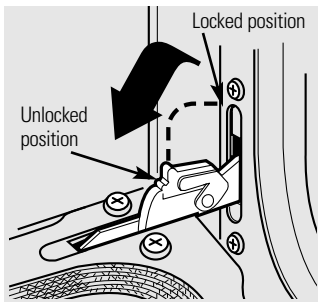

Pull the hinge locks down to the unlocked position.

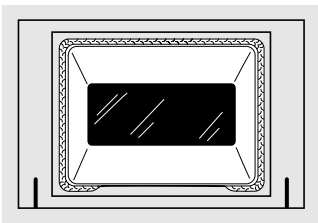

The gasket is designed with a gap at the bottom to allow for proper air circulation.

Do not rub or clean the door gasket—it has an extremely low resistance to abrasion.

If you notice the gasket becoming worn, frayed or damaged in any way or if it has become displaced on the door, you should have it replaced.

Lift-Off Oven Door

The oven door is removable for easier access to the light bulb.

Do not lift the door by the handle.

To remove the door:

- 1 Fully open the door.
- 2 Each hinge has a hinge lock. Using a tool, pull the hinge locks down against the door frame.
- 3 Firmly grasp the door **at the top sides**.
- 4 Close the door to the stop position.
- 5 Lift the door up and pull straight out.

To replace the door:

- 1 Firmly grasp the door **at the top sides**. **This is critical.**
- 2 Approach the range with the door angled in a vertical position.

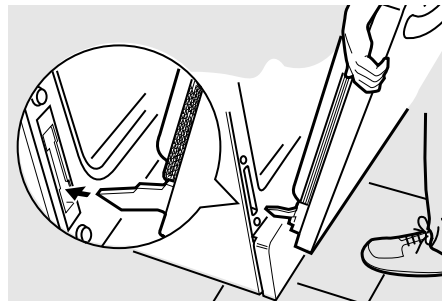

- 3 Guide the hinges into the slots.
- 4 Push door in firmly while opening.

- 5 Once in position, open the door completely. Push the hinge locks back in towards the front frame.

To clean the inside of the door:

- Because the area inside the gasket is cleaned during the self-clean cycle, you do not need to clean this by hand.
- The area outside the gasket and the door liner can be cleaned with a soap-filled steel wool or plastic pad, hot water and detergent. Rinse well with a vinegar and water solution.

To clean the outside of the door:

- Use soap and water to thoroughly clean the top, sides and front of the oven door. Rinse well. You may also use a glass cleaner to clean the glass on the outside of the door. Do not let water drip into the vent openings.
- If any stain on the door vent trim is persistent, use a soft abrasive cleaner and a sponge-scrubber for best results.
- Spillage of marinades, fruit juices, tomato sauces and basting materials containing acids may cause discoloration and should be wiped up immediately. When surface is cool, clean and rinse.
- Do not use oven cleaners, cleaning powders or harsh abrasives on the outside of the door.

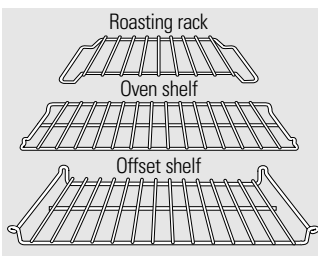

Oven Shelves and Convection Roasting Rack

Clean the oven shelves and the convection roasting rack with an abrasive cleanser or steel wool. After cleaning, rinse the shelves and rack with clean water and dry with a clean cloth.

NOTE: The oven shelves and convection roasting rack may be cleaned in the self-cleaning oven. However, the shelves will darken in color, lose their luster and become hard to slide if cleaned during the self-cleaning cycle.

To make the shelves slide more easily apply a small amount of vegetable oil or cooking oil to a paper towel and wipe the edges of the oven shelves with the paper towel.

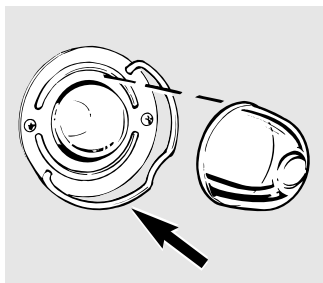

Wire cover holder.

Oven Light Replacement

CAUTION: Before replacing your oven light bulb, disconnect the electrical power to the range at the main fuse or circuit breaker panel.

Be sure to let the light cover and bulb cool completely.

To remove the cover:

- 1 Hold a hand under the cover so it doesn't fall when released. With fingers of the same hand, firmly push back the wire cover holder. Lift off the cover.

Do not remove any screws to remove the cover.

- 2 Replace bulb with a 40-watt appliance bulb.

To replace the cover:

- 1 Place it into groove of the light receptacle. Pull wire forward to the center of the cover until it snaps into place.
- 2 Connect electrical power to the range.

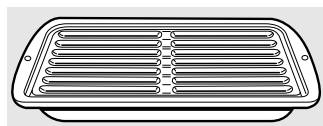

Do not store a soiled broiler pan and grid anywhere in the range.

Broiler Pan & Grid

Do not clean the broiler pan or grid in a self-cleaning oven.

After broiling, remove the broiler pan from the oven. Remove the grid from the pan. Carefully pour out the grease from the pan into a proper container.

Wash and rinse the broiler pan and grid in hot water with a soap-filled or plastic scouring pad.

If food has burned on, sprinkle the grid with detergent while hot and cover with wet paper towels or a dishcloth. Soaking the pan will remove burned-on foods.

Both the broiler pan and grid may be cleaned with a commercial oven cleaner.

Both the broiler pan and grid can also be cleaned in a dishwasher.

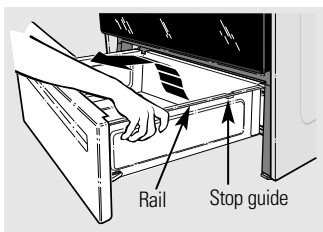

Storage Drawer Removal

To remove the drawer:

- 1 Pull the drawer out until it stops.
- 2 Lift the front of the drawer until the stops clear the guides.
- 3 Remove the drawer.

To replace the drawer:

- 1 Place the drawer rails on the guides.
- 2 Push the drawer back until it stops.
- 3 Lift the front of the drawer and push back until the stops clear the guides.
- 4 Lower the front of the drawer and push back until it closes.

Oven Heating Elements

Do not clean the broil element. Any soil will burn off when the element is heated. To clean the oven floor, gently lift the bake element. Clean with warm, soapy water.

On some models, the bake element is not exposed and is under the oven floor. If spillovers, residue or ash accumulate on the oven floor, wipe up before self-cleaning.

Painted Surfaces

Painted surfaces include the sides of the range and the door, top of control panel and the drawer front. Clean these with soap and water or a vinegar and water solution.

Do not use commercial oven cleaners, cleaning powders, steel wool or harsh abrasives on any painted surface.

Cleaning the glass cooktop.

Clean the glass surface with cleaning cream before you use the cooktop for the first time. Also, clean the glass surface after each use. This helps protect the top and makes clean-up easier.

To clean the cooktop seal around the edge of the glass, let a wet cloth rest on it for a few minutes, then wipe clean. Use a mild detergent if needed.

Do not use a knife or any sharp object on the seal because it will cut or damage it.

Normal Cleaning

Use only a recommended cleaning cream, such as Cerama Brite or another cooktop cleaning cream, on the glass cooktop.

To maintain and protect the surface of your new glass cooktop follow these steps.

- 1 Before you use the cooktop for the first time, clean it with cleaning cream. This helps protect the top and makes clean-up easier.

- 2 Clean the surface with the cleaning cream after each use.
- 3 Rub a few drops (less is better) of the cleaning cream onto soiled area using a damp paper towel. Buff with a dry paper towel until all soil and cream are removed.

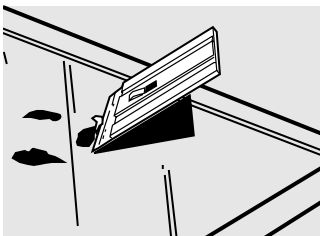

Using a razor scraper will not damage the surface if the 45° angle is maintained.

For Heavy, Burned-On Soil...

- 1 Allow the cooktop to cool.
- 2 Apply a few drops of cleaning cream to the cool, soiled area. Spread the cream across the entire soiled area.
- 3 Hold scraper at a 45° angle against the glass ceramic surface. This 45° angle makes the scraping easier.
- 4 Scrape soil with the enclosed razor scraper. Keep small amount of cream on the soil as you scrape. Heavily soiled areas may require repeated applications of cream. It will be necessary to press down on

the razor scraper while scraping the soiled area with cooktop cream.

Be sure to use a new sharp razor scraper. Do not use a dull or nicked blade.

- 5 If any soil remains, repeat the steps listed above.

To order more cream and/or scrapers for cleaning your glass cooktop, please call our toll-free number:

National Parts Center 800-626-2002

Cleaner # WX10X300
Scraper # WX5X1614
Cream & scraper kit # WB64X5027

Our testing shows that if you are cooking high sugar mixtures such as jelly or fudge and have a spillover, permanent damage to the cooktop surface may occur unless the spillover is immediately removed.

Special Care for Sugary Spills

Be sure to use a new sharp razor scraper. Do not use a dull or nicked blade.

Sugary spillovers (such as jellies, fudge, candy syrups) or melted plastics can cause pitting of the surface of your cooktop (not covered by the warranty) unless the spill is removed while still hot. **Special care should be taken when removing hot substances.**

- 1 Turn off all surface units affected by the spillover. Remove hot pans.
- 2 Wearing an oven mitt, hold the razor scraper at a 45° angle to the cooktop. Scrape the hot spill to a cool area outside the surface unit.

- 3 With the spill in a cool area, use a dry paper towel to remove any excess. Any spillover remaining should be left until the surface of the cooktop has cooled. Do not continue to use the soiled surface unit until all of the spillover has been removed. Follow the steps under *Heavy Burned-On Soil* to continue the cleaning process.

NOTE: *If pots with a thin overlay of aluminum, copper or enamel are allowed to boil dry, the overlay may bond with the glass cooktop and leave a black discoloration. This should be removed immediately before heating again or the discoloration may be permanent.*

Before You Call For Service...



Troubleshooting Tips
 Save time and money! Review the charts on the following pages first and you may not need to call for service.

Problem	Possible Causes	What To Do
Surface units will not maintain a rolling boil or cooking is not fast enough	Improper cookware being used.	<ul style="list-style-type: none"> Use pans which are flat and match the diameter of the surface unit selected.
Surface units do not work properly	A fuse in your home may be blown or the circuit breaker tripped.	<ul style="list-style-type: none"> Replace the fuse or reset the circuit breaker.
	Cooktop controls improperly set.	<ul style="list-style-type: none"> Check to see the correct control is set for the surface unit you are using.
Tiny scratches (may appear as cracks) or abrasions on radiant cooktop glass surface	Incorrect cleaning methods being used.	<ul style="list-style-type: none"> Use recommended cleaning procedures.
	Cookware with rough bottoms being used or coarse particles (salt or sand) were between the cookware and the surface of the cooktop.	<ul style="list-style-type: none"> Be sure cookware bottoms and cookware are clean before use. Use cookware with smooth bottoms. Tiny scratches are not removable but will become less visible in time as a result of cleaning.
	Cookware has been slid across the cooktop surface.	
Areas of discoloration on the cooktop	Improper cookware being used.	<ul style="list-style-type: none"> Marks from aluminum and copper pans as well as mineral deposits from water or food can be removed with the cleaning cream.
	Hot surface on a model with a white glass cooktop.	<ul style="list-style-type: none"> This is normal. The surface may appear discolored when it is hot. This is temporary and will disappear as the glass cools.
Plastic melted to the surface	Hot cooktop came into contact with plastic placed on the hot cooktop.	<ul style="list-style-type: none"> See the <i>Special Care</i> information in the <i>Cleaning the glass cooktop</i> section.
Pitting of the cooktop	Hot sugar mixture spilled on the cooktop.	<ul style="list-style-type: none"> Call a qualified technician for replacement.
Frequent cycling off and on of surface units	Improper cookware being used.	<ul style="list-style-type: none"> Use only flat cookware to minimize cycling.
Oven light does not work	Light bulb is loose or defective.	<ul style="list-style-type: none"> Tighten or replace the bulb.
	Switch operating light is broken.	<ul style="list-style-type: none"> Call for service.
Oven will not work	Plug on range is not completely inserted in the electrical outlet.	<ul style="list-style-type: none"> Make sure electrical plug is plugged into a live, properly grounded outlet.
	A fuse in your home may be blown or the circuit breaker tripped.	<ul style="list-style-type: none"> Replace the fuse or reset the circuit breaker.
	Oven controls improperly set.	<ul style="list-style-type: none"> See the <i>Using the oven</i> section.

Safety Instructions

Operating Instructions

Care and Cleaning

Troubleshooting Tips

Customer Service

Before You Call For Service...



Troubleshooting Tips

Problem	Possible Causes	What To Do
Food does not bake or roast properly	Oven controls improperly set.	• See the <i>Using the oven</i> section.
	Shelf position is incorrect or the shelf is not level.	• See the <i>Using the oven</i> section.
	Incorrect cookware or cookware of improper size being used.	• See the <i>Using the oven</i> section.
	Oven thermostat needs adjustment.	• See the <i>Adjust the oven thermostat—Do it yourself!</i> section.
Food does not broil properly	Oven controls improperly set.	• Make sure you touch the BROIL HI/LO pad.
	Door not open to the broil stop position as recommended.	• See the <i>Using the oven</i> section.
	Improper shelf position being used.	• See the <i>Broiling Guide</i> .
	Cookware not suited for broiling.	• Use the broiling pan and grid that came with your range.
	The probe is plugged into the outlet in the oven. (on some models)	• Unplug and remove the probe from the oven.
	Aluminum foil used on the the broiling pan and grid has not been fitted properly and slit as recommended.	• See the <i>Using the oven</i> section.
	In some areas the power (voltage) may be low.	• Preheat the broil element for 10 minutes. • Broil for the longest period of time recommended in the <i>Broiling Guide</i> .
Oven temperature too hot or too cold	Oven thermostat needs adjustment.	• See the <i>Adjust the oven thermostat—Do it yourself!</i> section.
Storage drawer is crooked	Rear drawer support is on top of the guide rail.	• Reposition the drawer. See the <i>Storage Drawer Removal</i> instructions in the <i>Care and cleaning of your range</i> section.
Storage drawer won't close	Power cord may be obstructing drawer in the lower back of the range.	• Reposition the drawer and power cord. See the <i>Storage Drawer Removal</i> instructions in the <i>Care and cleaning of your range</i> section.
	Rear drawer support is on top of the guide rail.	Reposition the drawer. See the <i>Storage Drawer Removal</i> instructions in the <i>Care and cleaning of your range</i> section.

Problem	Possible Causes	What To Do
Clock and timer do not work	Plug on range is not completely inserted in the electrical outlet.	<ul style="list-style-type: none"> • Make sure electrical plug is plugged into a live, properly grounded outlet.
	A fuse in your home may be blown or the circuit breaker tripped.	<ul style="list-style-type: none"> • Replace the fuse or reset the circuit breaker.
	Oven controls improperly set.	<ul style="list-style-type: none"> • See the <i>Using the clock and timer</i> section.
Oven will not self-clean	The oven temperature is too high to set a self-clean operation.	<ul style="list-style-type: none"> • Allow the range to cool to room temperature and reset the controls.
	Oven controls improperly set.	<ul style="list-style-type: none"> • See the <i>Using the self-cleaning oven</i> section.
	The probe is plugged into the outlet in the oven. (on some models)	<ul style="list-style-type: none"> • Remove the probe from the oven.
"Crackling" or "popping" sound	This is the sound of the metal heating and cooling during both the cooking and cleaning functions.	<ul style="list-style-type: none"> • This is normal.
Excessive smoking during a clean cycle	Excessive soil.	<ul style="list-style-type: none"> • Touch the CLEAR/OFF pad. Open the windows to rid the room of smoke. Wait until the LOCKED DOOR light goes off. Wipe up the excess soil and reset the clean cycle.
Oven door will not open after a clean cycle	Oven too hot.	<ul style="list-style-type: none"> • Allow the oven to cool below locking temperature.
Oven not clean after a clean cycle	Oven controls not properly set.	<ul style="list-style-type: none"> • See the <i>Using the self-cleaning oven</i> section.
	Oven was heavily soiled.	<ul style="list-style-type: none"> • Clean up heavy spillovers before starting the clean cycle. Heavily soiled ovens may need to self-clean again or for a longer period of time.
"LOCK DOOR" flashes in the display	The self-clean cycle has been selected but the door is not closed.	<ul style="list-style-type: none"> • Close the oven door.
LOCKED DOOR light is on when you want to cook	The oven door is locked because the temperature inside the oven has not dropped below the locking temperature.	<ul style="list-style-type: none"> • Touch the CLEAR/OFF pad. Allow the oven to cool.
"F—and a number or letter" flash in the display	You have a function error code.	<ul style="list-style-type: none"> • Touch the CLEAR/OFF pad. Put the oven back into operation.
	If the function code repeats.	<ul style="list-style-type: none"> • Disconnect all power to the range for at least 30 seconds and then reconnect power. If the function error code repeats, call for service.

Before You Call For Service...



Troubleshooting Tips

Problem	Possible Causes	What To Do
Control signals after entering cooking time or start time	You forgot to enter a bake temperature or cleaning time.	<ul style="list-style-type: none"> • Touch the BAKE pad and desired temperature or the SELF CLEAN pad and desired clean time.
Display goes blank	<p>A fuse in your home may be blown or the circuit breaker tripped.</p> <p>The clock is in the black-out mode.</p>	<ul style="list-style-type: none"> • Replace the fuse or reset the circuit breaker. • See the <i>Special features of your oven control</i> section.
Display flashes	Power failure.	<ul style="list-style-type: none"> • Reset the clock.
Unable to get the display to show "SF"	Oven control pads were not touched properly.	<ul style="list-style-type: none"> • The BAKE and BROIL HI/LO pads must be touched at the same time and held for 3 seconds.
"Probe" appears in the display (on some models)	This is reminding you to enter a probe temperature after plugging in the probe.	<ul style="list-style-type: none"> • Enter a probe temperature.
Power outage, clock flashes	Power outage or surge.	<ul style="list-style-type: none"> • Reset the clock. If the oven was in use, you must reset it by touching the CLEAR/OFF pad, setting the clock and resetting any cooking function.
Steam from the vent	When using the convection feature, it is normal to see steam coming out of the oven vent. As the number of shelves or amount of food being cooked increases, the amount of visible steam will increase.	<ul style="list-style-type: none"> • This is normal.
"Burning" or "oily" odor emitting from the vent	This is normal in a new oven and will disappear in time.	<ul style="list-style-type: none"> • To speed the process, set a self-clean cycle for a minimum of 3 hours. See the <i>Using the self-cleaning oven</i> section.
Strong odor	An odor from the insulation around the inside of the oven is normal for the first few times the oven is used.	<ul style="list-style-type: none"> • This is temporary.
Fan noise	A cooling fan or a convection fan (depending on the function you are using) may automatically turn on and off to cool internal parts.	<ul style="list-style-type: none"> • This is normal. The cooling fan will turn off and on. The convection fan will run until the function is over or the door is opened.
Surface light does not work 	Switch operating light is broken.	<ul style="list-style-type: none"> • Call for service.

GE Service Protection Plus™

GE, a name recognized worldwide for quality and dependability, offers you Service Protection Plus™—comprehensive protection on all your appliances—**No Matter What Brand!**

Benefits Include:

- Backed by GE
- All brands covered
- Unlimited service calls
- All parts and labor costs included
- No out-of-pocket expenses
- No hidden deductibles
- One 800 number to call

***We'll Cover Any Appliance.
Anywhere. Anytime.****

You will be completely satisfied with our service protection or you may request your money back on the remaining value of your contract. No questions asked. It's that simple.

Protect your refrigerator, dishwasher, washer and dryer, range, TV, VCR and much more—**any brand!** Plus there's no extra charge for emergency service and low monthly financing is available. Even icemaker coverage and food spoilage protection is offered. You can rest easy, knowing that all your valuable household products are protected against expensive repairs.

Place your confidence in GE and call us in the U.S. toll-free at **800-626-2224** for more information.

*All brands covered, up to 20 years old, in the continental U.S.



Please place in envelope and mail to:

General Electric Company
Warranty Registration Department
P.O. Box 32150
Louisville, KY 40232-2150

Consumer Product Ownership Registration

Dear Customer:

Thank you for purchasing our product and thank you for placing your confidence in us.

We are proud to have you as a customer!

Follow these three steps to protect your new appliance investment:

1 Complete and mail your Consumer Product Ownership Registration today. Have the peace of mind of knowing we can contact you in the unlikely event of a safety modification.

2 After mailing the registration below, store this document in a safe place. It contains information you will need should you require service. Our service number is 800 GE CARES (800-432-2737).

3 Read your Owner's Manual carefully. It will help you operate your new appliance properly. If you have questions, or need more information, call the GE Answer Center® 800.626.2000.

Model Number

Serial Number

Important: If you did not get a registration card with your product, detach and return the form below to ensure that your product is registered, or register online at www.geappliances.com.

 Cut here

Consumer Product Ownership Registration



Model Number

Serial Number

Mr. Ms. Mrs. Miss

First Name

Last Name

Street Address

Apt. #

E-mail Address

City

State

Zip Code

Date Placed In Use
Month

Day

Year

Phone Number --

Occasionally, we may allow selected companies to send you information.

Check here if you do not want this information.



GE Appliances

General Electric Company
Louisville, Kentucky
www.geappliances.com

GE Electric Range Warranty



All warranty service provided by our Factory Service Centers or an authorized Customer Care® technician. For service, call 800-GE-CARES.

For The Period Of:	GE Will Provide:
One Year From the date of the original purchase	Any part of the range which fails due to a defect in materials or workmanship. During this full one-year warranty , GE will also provide, free of charge , all labor and in-home service to replace the defective part.
Five Years From the date of the original purchase	A replacement glass cooktop if it should crack due to thermal shock, discolor, or crack at the rubber seal between the glass cooktop and the porcelain edge. It will also be replaced if the pattern wears off or if any of the radiant surface units burn out. During this five-year warranty , you will be responsible for any labor or in-home service.

What GE Will Not Cover:

- Service trips to your home to teach you how to use the product.
- Improper installation.
- Failure of the product if it is abused, misused, or used for other than the intended purpose or used commercially.
- Damage to the glass cooktop caused by use of cleaners other than the recommended cleaning creams.
- Damage to the glass cooktop caused by hardened spills of sugary materials or melted plastic that are not cleaned according to the directions in the Owner's Manual.
- Replacement of house fuses or resetting of circuit breakers.
- Damage to the product caused by accident, fire, floods or acts of God.
- Incidental or consequential damage to personal property caused by possible defects with this appliance.

This warranty is extended to the original purchaser and any succeeding owner for products purchased for home use within the USA. In Alaska, the warranty excludes the cost of shipping or service calls to your home.

Some states do not allow the exclusion or limitation of incidental or consequential damages. This warranty gives you specific legal rights, and you may also have other rights which vary from state to state. To know what your legal rights are, consult your local or state consumer affairs office or your state's Attorney General.

Warrantor: General Electric Company, Louisville, KY 40225

Service Telephone Numbers.



GE Answer Center® 800.626.2000

The GE Answer Center® is open 24 hours a day, 7 days a week.



In-Home Repair Service 800-GE-CARES (800-432-2737)

Expert GE repair service is only a phone call away.

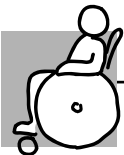

Special Needs Service 800.626.2000

800-TDD-GEAC (800-833-4322)

GE offers, free of charge, a brochure to assist in planning a barrier-free kitchen for persons with limited mobility.



Service Contracts 800-626-2224

Purchase a GE service contract while your warranty is still in effect and you'll receive a substantial discount. GE Consumer Service will still be there after your warranty expires.

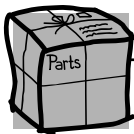

Parts and Accessories 800-626-2002

Individuals qualified to service their own appliances can have parts or accessories sent directly to their homes (VISA, MasterCard and Discover cards are accepted).

Instructions contained in this manual cover procedures to be performed by any user. Other servicing generally should be referred to qualified service personnel. Caution must be exercised, since improper servicing may cause unsafe operation.



Service Satisfaction

If you are not satisfied with the service you receive from GE:

First, contact the people who serviced your appliance.

Next, if you are still not pleased, write all the details—including your phone number—to:

Manager, Customer Relations
 GE Appliances
 Appliance Park
 Louisville, KY 40225

Free Manuals Download Website

<http://myh66.com>

<http://usermanuals.us>

<http://www.somanuals.com>

<http://www.4manuals.cc>

<http://www.manual-lib.com>

<http://www.404manual.com>

<http://www.luxmanual.com>

<http://aubethermostatmanual.com>

Golf course search by state

<http://golfingnear.com>

Email search by domain

<http://emailbydomain.com>

Auto manuals search

<http://auto.somanuals.com>

TV manuals search

<http://tv.somanuals.com>