



Use and Care Guide

Self-Cleaning Solid Disk Electric Range



Safety Instructions	3-5
Anti-Tip Device.....	3, 32



Operating Instructions, Tips	
Aluminum Foil	5, 19, 20, 22
Clock and Timer	13
Features.....	6, 7
Oven	13-27
Baking.....	15-19
Broiling, Broiling Guide	22, 23
Control Panel.....	13
Light, Bulb Replacement.....	15, 30
Roasting, Roasting Guide	20, 21
Self-Cleaning Instructions	24-27
Thermostat Adjustment	15
Timed Baking	16, 17
Surface Cooking.....	8-12
Control Settings.....	9
Cookware Tips.....	8, 10
Home Canning Tips	12
Surface Light.....	9, 29



Problem Solver	33, 34
More questions?...call <i>GE Answer Center® 800.626.2000</i>	



Care and Cleaning	28-32
Anti-Tip Device	32
Broiler Pan and Rack	30
Door Removal.....	31
Glass Top.....	28
Shelves	31
Solid Disk Surface Units.....	28
Storage Drawer	30



Consumer Services	35
Appliance Registration.....	2
Important Phone Numbers.....	35
Model and Serial Number Location.....	2
Warranty	Back Cover

GE Appliances

Models:

**JBP29G
JB570GM
JB571GM**

MNU106 Rev. 2



HELP US HELP YOU...

Before using your range, read this book carefully.

It is intended to help you operate and maintain your new range properly.

Keep it handy for answers to your questions.

If you don't understand something or need more help, write (include your phone number):

Consumer Affairs
GE Appliances
Appliance Park
Louisville, KY 40225

Write down the model and serial numbers.

You'll find them on a label on the front of the range behind the storage drawer.

These numbers are also on the Consumer Product Ownership Registration Card that came with your range. Before sending in this card, please write these numbers here:

Model Number

Serial Number

Use these numbers in any correspondence or service calls concerning your range.

If you received a damaged range...

Immediately contact the dealer (or builder) that sold you the range.

Save time and money. Before you request service...

Check the Problem Solver in the back of this book. It lists causes of minor operating problems that you can correct yourself.

IF YOU NEED SERVICE...

To obtain service, see the Consumer Services page in the back of this book.

We're proud of our service and want you to be pleased. If for some reason you are not happy with the service you receive, here are three steps to follow for further help.

FIRST, contact the people who serviced your appliance. Explain why you are not pleased. In most cases, this will solve the problem.

NEXT, if you are still not pleased, write all the details—including your phone number—to:

Manager, Consumer Relations
GE Appliances
Appliance Park
Louisville, KY 40225

FINALLY, if your problem is still not resolved, write:

Major Appliance Consumer Action Panel
20 North Wacker Drive
Chicago, IL 60606

IMPORTANT SAFETY INSTRUCTIONS

Read All Instructions Before Using Your Range.



IMPORTANT SAFETY NOTICE

- **The California Safe Drinking Water and Toxic Enforcement Act** requires the Governor of California to publish a list of substances known to the state to cause birth defects or other reproductive harm, and requires businesses to warn customers of potential exposure to such substances.
- **The fiberglass insulation in self-clean ovens gives off a very small amount of carbon monoxide during the cleaning cycle.** Exposure can be minimized by venting with an open window or using a ventilation fan or hood.
- **Fluorescent light bulbs contain mercury.** If your model has a surface lamp, you must recycle the fluorescent light bulb according to local, state and federal codes.

When using electrical appliances, basic safety precautions should be followed, including the following:

- Use this appliance only for its intended use as described in this manual.
- Be sure your appliance is properly installed and grounded by a qualified technician in accordance with the provided Installation Instructions.
- Do not attempt to repair or replace any part of your range unless it is specifically recommended in this book. All other servicing should be referred to a qualified technician.
- Before performing any service, **DISCONNECT THE RANGE POWER SUPPLY AT THE HOUSEHOLD DISTRIBUTION PANEL BY REMOVING THE FUSE OR SWITCHING OFF THE CIRCUIT BREAKER.**

WARNING—

All ranges can tip and injury could result. To prevent accidental tipping of the range from abnormal usage, including excess loading of the oven door, attach it to the wall or floor by installing the Anti-Tip device supplied. To insure the device is properly installed and engaged, remove the drawer panel and inspect the rear leveling leg. Make sure it fits securely into the slot.

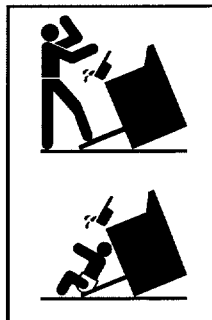

If you pull the range out from the wall for any reason, make sure the device engages the range when you push the range back. Please refer to the Anti-Tip device information in this book. Failure to take this precaution could result in tipping of the range and injury.

- **Do not leave children alone**—children should not be left alone or unattended in an area where an appliance is in use. They should never be allowed to sit or stand on any part of the appliance.
- **CAUTION: ITEMS OF INTEREST TO CHILDREN SHOULD NOT BE STORED IN CABINETS ABOVE A RANGE OR ON THE BACKSPASH OF A RANGE—CHILDREN CLIMBING ON THE RANGE TO REACH ITEMS COULD BE SERIOUSLY INJURED.**
- **Teach children not to play with the controls** or any other part of the range.
- **Never leave the oven door open** when you are not watching the range.
- **Always keep combustible wall coverings, curtains or drapes a safe distance from your range.**
- **Do not allow anyone to climb, stand or hang on the door, drawer or range top.** They could damage the range and even tip it over, causing severe personal injury.
- **Never wear loose-fitting or hanging garments while using the appliance.** Flammable material could be ignited if brought in contact with hot heating elements and may cause severe burns.
- **Use only dry pot holders**—moist or damp pot holders on hot surfaces may result in burns from steam. Do not let pot holders touch hot heating elements. Do not use a towel or other bulky cloth. Such cloths can catch fire on a hot surface unit.
- **Always keep dish towels, dish cloths, pot holders and other linens a safe distance from your range.**
- **Always keep wooden and plastic utensils and canned food a safe distance away from your range.**
- **For your safety, never use your appliance for warming or heating the room.**



(continued next page)



IMPORTANT SAFETY INSTRUCTIONS

(continued)

- **Do not store flammable materials in an oven or near the cooktop.**
- **DO NOT STORE OR USE COMBUSTIBLE MATERIALS, GASOLINE OR OTHER FLAMMABLE VAPORS AND LIQUIDS IN THE VICINITY OF THIS OR ANY OTHER APPLIANCE.**
- **Keep hood and grease filters clean** to maintain good venting and to avoid grease fires.
- **Do not let cooking grease or other flammable materials accumulate in or near the range.**

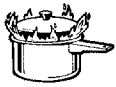

- **Do not use water on grease fires. Never pick up a flaming pan.** Smother flaming pan on the surface unit by covering pan completely with well-fitting lid, cookie sheet or flat tray, or if available, use dry chemical or foam-type extinguisher.

Flaming grease outside a pan can be put out by covering with baking soda or, if available, a multi-purpose dry chemical or foam-type fire extinguisher.

Flame in the oven can be smothered completely by closing the oven door and pushing the CANCEL button or use a chemical or foam-type extinguisher.

- **Do not touch the heating elements or interior surface of oven and surface units.** These surfaces may be hot enough to burn even though they are dark in color. During and after use, do not touch, or let clothing or other flammable materials contact surface units, areas nearby surface units or any interior area of the oven; allow sufficient time for cooling, first.
Potentially hot surfaces include the cooktop and areas facing the cooktop, oven vent opening and surfaces near the opening, and crevices around the oven door, and metal trim parts above the door.
Remember: The inside surface of the oven may be hot when the door is opened.
- **Do not cook on a broken glass cooktop.** Spillovers or cleaning solution may penetrate a broken cooktop and create a risk of electrical shock. Contact a qualified technician immediately should your cooktop become broken.
- **Use care when touching the cooktop.** The glass surface of the cooktop will retain heat after the controls have been turned off.



- **Clean the cooktop with caution.** If a wet sponge or cloth is used to wipe spills on a hot cooking area, be careful to avoid steam burn. Some cleansers can produce noxious fumes if applied to a hot surface.
- **When cooking pork,** follow the directions exactly and always cook the meat to an internal temperature of at least 170°F. This assures that, in the remote possibility that trichina may be present in the meat, it will be killed and the meat will be safe to eat.

Oven

- **Stand away from range when opening oven door.** Hot air or steam which escapes can cause burns to hands, face and/or eyes.
- **Do not heat unopened food containers.** Pressure could build up and the container could burst, causing an injury.
- **Keep the oven vent duct unobstructed.**
- **Keep the oven free from grease buildup.**
- **Place the oven shelf in the desired position while the oven is cool.** If the shelves must be handled when hot, do not let pot holder contact the heating units in the oven.
- **Pulling out the shelf to the shelf stop is a convenience in lifting heavy foods. It is also a precaution against burns from touching hot surfaces of the door or oven walls.**
- **When using cooking or roasting bags in oven,** follow the manufacturer's directions.
- **Do not use your oven to dry newspapers.** If overheated, they can catch fire.
- **Do not use oven for a storage area.** Items stored in an oven can ignite.
- **Do not leave paper products, cooking utensils, or food in the oven when not in use.**
- **After broiling,** always take the broiler pan out of the range and clean it. Leftover grease in the broiler pan can catch fire the next time you use the pan.
- **Never leave jars or cans of fat drippings on or near your oven.**



Self-Cleaning Oven

- **Do not clean the door gasket.** The door gasket is essential for a good seal. Care should be taken not to rub, damage or move the gasket.
- **Do not use oven cleaners.** No commercial oven cleaner or oven liner protective coating of any kind should be used in or around any part of the oven. Residue from oven cleaners will damage the inside of the oven when the self-clean cycle is used.
- **Clean only parts listed in this Use and Care Book.**
- **Before self-cleaning the oven, remove broiler pan and other cookware.**
- **Do not use aluminum foil** to line oven bottoms, except as suggested in manual. Improper installation of these liners may result in a risk of electric shock or fire.
- **Be sure to wipe up excess spillage before starting the self-cleaning operation.**
- **If the self-cleaning mode malfunctions, turn off and disconnect the power supply.** Have serviced by a qualified technician.

Surface Cooking Elements

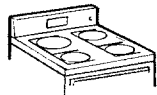

- **Use proper pan size**—This appliance is equipped with one or more solid disk surface units of different size. Select cookware having flat bottoms large enough to cover the solid disk surface unit. The use of undersized cookware will expose a portion of the surface unit to direct contact and may result in ignition of clothing. Proper relationship of cookware to surface unit will also improve efficiency.
- **Never leave the solid disk surface units unattended at high heat settings.** Boilover causes smoking and greasy spillovers that may catch on fire.
- **Do not cook on a broken cooktop.** Spillovers or cleaning solutions may penetrate a broken cooktop and create a risk of electrical shock. Contact a qualified technician immediately should your glass cooktop become broken.

- **Only certain types of glass, glass/ceramic, earthenware or other glazed containers are suitable for range-top service;** others may break because of the sudden change in temperature.
- **To minimize the possibility of burns,** ignition of flammable materials and spillage, the handle of a container should be turned toward the center of the range without extending over nearby solid disk surface units.
- **Never try to clean the cooktop surface when it is hot.** Some cleaners produce noxious fumes and wet cloths could cause steam burns if used on a hot surface.
- **Always turn solid disk surface units to OFF before removing cookware.**
- **Use of decorative metal covers on solid disk surface units is not recommended.** If a covered unit is turned on, element burnout could result.
- **Keep an eye on foods being fried at HI or Medium High heat settings.**
- **When flaming foods are under the hood, turn the fan off.** The fan, if operating, may spread the flame.
- **Foods for frying should be as dry as possible.** Frost on frozen foods or moisture on fresh foods can cause hot fat to bubble up and over sides of pan.
- **Use little fat for effective shallow or deep-fat frying.** Filling the pan too full of fat can cause spillovers when food is added.
- **If a combination of oils or fats will be used in frying,** stir together before heating, or as fats melt slowly.
- **Always heat fat slowly,** and watch as it heats.
- **Use deep fat thermometer whenever possible** to prevent overheating fat beyond the smoking point.
- **Never try to move a pan of hot fat, especially a deep fat fryer.** Wait until the fat is cool.

**SAVE THESE
INSTRUCTIONS**



FEATURES OF YOUR RANGE

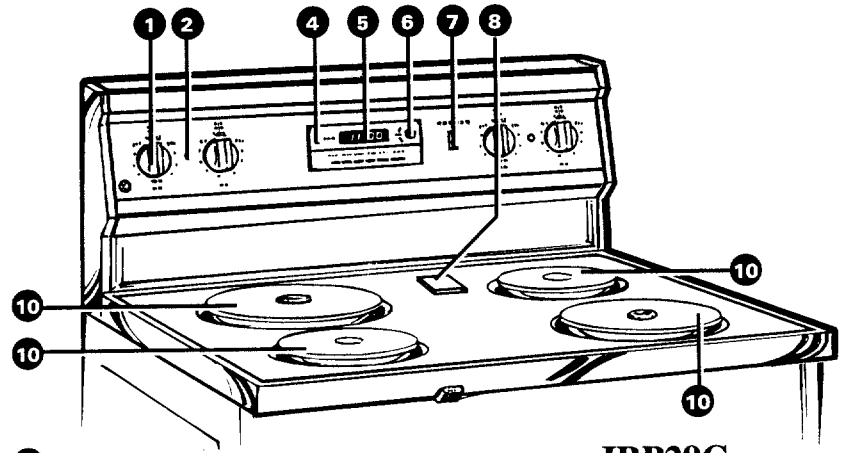

JBP29G

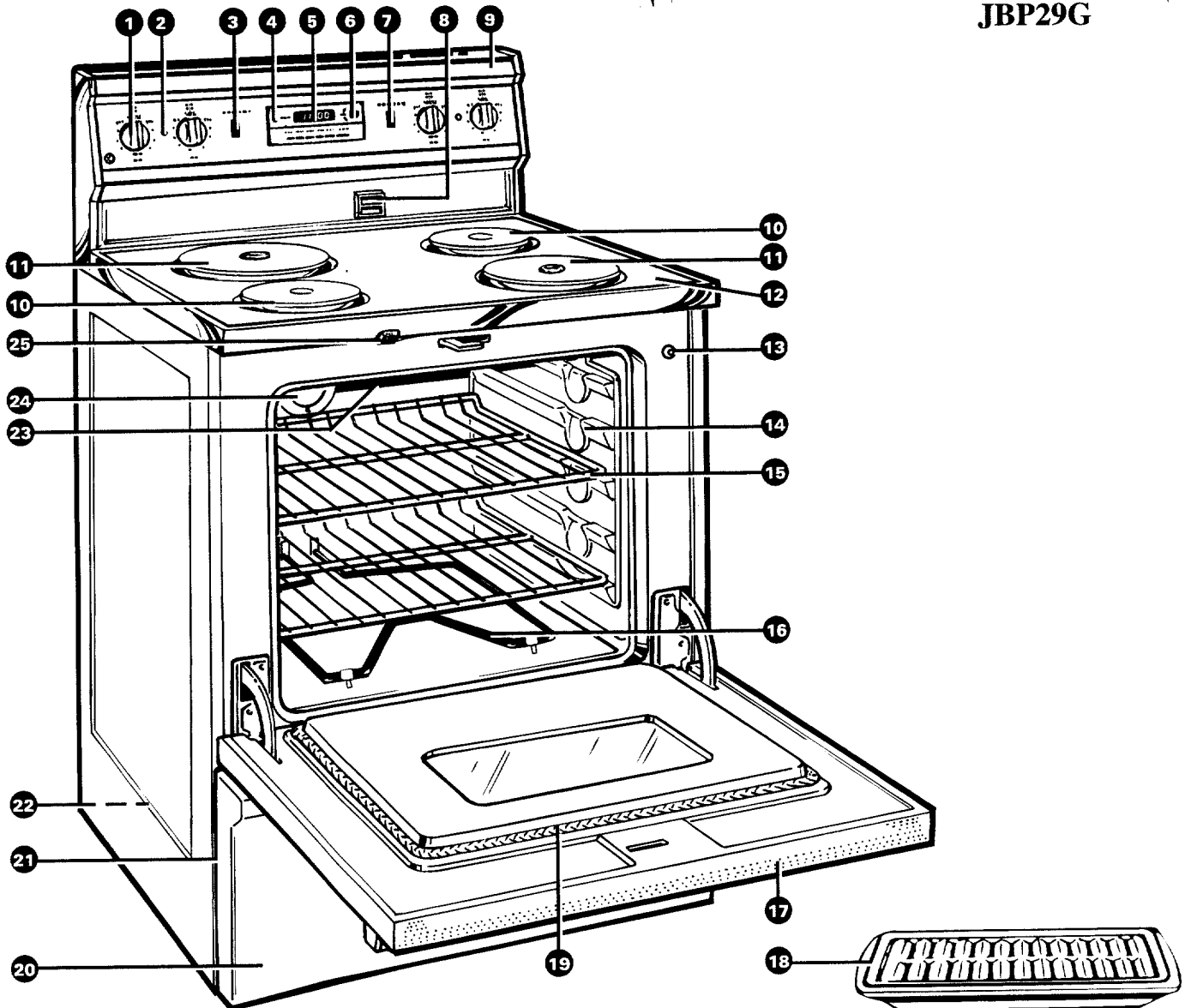

**JBP570GM
JBP571GM**



Feature Index	Explained on page
1 Solid Disk Element Surface Unit Controls	5, 9, 29
2 “ON” Indicator Light for Solid Disk Element Surface Units	9
3 Surface Light Switch (on some models)	9
4 Oven CANCEL button Push it to cancel any oven operation.	4, 13, 15 16, 22
5 Oven Control, Clock and Timer	13
6 Set Knob Lets you set oven temperature, clock timer and HI or LO broil.	13, 15–17, 20 22, 25, 26
7 Oven Light Switch Lets you turn the interior oven light on and off when the door is closed.	15
8 Oven Vent. Area may get hot during oven use.	4, 30
9 Cooktop Surface Light (on some models)	3, 9, 29
10 Solid Disk Element Surface Units	5, 8–12, 28
11 Sensi-Temp™ Surface Units (on some models)	9
12 Cooktop	4, 5, 29
13 Automatic Oven Light Switch The light comes on automatically when the door is opened.	15
14 Oven Shelf Supports For shelf positions, see the Baking, Roasting and Broiling sections.	14
15 Oven Shelves with Stop-locks (curved extensions) For safety, facing up toward the rear of the oven.	4, 14, 18, 24, 31
16 Bake Unit. May be gently lifted for wiping the oven floor.	31
17 Removable Oven Door with Broil Stop Position Easily removed for oven cleaning.	31
18 Broiler Pan and Rack Do not clean in the Self-Cleaning oven.	4, 20, 22, 24, 30
19 Oven Door Gasket	5, 24, 31
20 Storage Drawer	30
21 Model and Serial Number Location On the front of the range behind the storage drawer.	2
22 Anti-Tip Device. See the Installation Instructions.	3, 32
23 Broil Unit	31
24 Oven Interior Light	15, 24, 30
25 Oven Door Latch Handle. Use for Self-Cleaning cycle only.	15, 16, 20, 22 25, 26



SURFACE COOKING

Before Using Your Solid Disk Module for the First Time

The top working surface of solid disk elements have a protective coating which must be hardened before using the elements for the first time. To harden this coating, the elements should be heated without a pan for about 5 minutes at the HI setting. Otherwise the coating will stick to the pan.

There will be some smoke and odor; this is normal. Heating of the element will change the stainless steel element trim rings to a gold color.

THE ELEMENT PROTECTIVE COATING MUST BE HARDENED TO HELP PROTECT THE ELEMENT OVER ITS LIFE.

General Information About Solid Disk Elements

Using a solid disk element is quite similar to using an electric coil surface unit. With both types of surface units you will enjoy the cleanliness of electricity and the benefits of retained heat in the elements. However, there are differences.

- **Solid disk elements reach temperature a little slower, and hold heat longer than coil units.** Solid disk elements have very even heat distribution. Since solid disk elements hold heat longer, you may wish to turn the element off sooner, and take advantage of the residual heat. The amount of residual heat is dependent upon the quantity and type of food, the material and thickness of the pan and the setting used for cooking.
- **The red dot in the center of the solid disk element indicates built-in temperature limiters** that automatically reduce the heat if a pan boils dry, if the element is turned on without a pan or if the pan is not making enough contact with the surface of the element. The red dots will wear off with use without affecting the performance of the elements.
- **There is retained heat in the element.** On boilovers, wait for the element to cool before cleaning the element area.
- **You must use proper flat bottomed cookware,** not cookware that is warped, rounded, or curved. Improper cookware could cause poor cooking results.
- **Unlike electric coil surface units, solid disk elements do NOT turn red hot, even at HI setting.** You may however, notice a dull glow when the elements are on HI and the room is dimly lit.
- **Solid disk element cooking takes you a step closer to easier cleanup** because the cooking surface is sealed against spills. There are no drip bowls or burner boxes to clean.

Cookware Tips

For cooking on solid disk elements, the use of correct cookware is very important.

- Aluminum cookware conducts heat faster than other metals.
- Cast-iron and coated cast-iron containers are slow to absorb heat, but generally cook evenly at minimum or medium heat settings.
- Glass cookware should be used only as the manufacturer describes.
- Do not use a wire trivet or any other kind of heat-retarding pad between the cookware and the element.
- Good pans have a thick, flat bottom which absorbs the heat from the element. The thick, flat bottom provides good heat distribution from the element to the food.
- Pans with thin, uneven bottoms do not do a good job of using the heat coming from the element. The food to be cooked may burn and require more time and electricity. You would also have to add more fat or water.

Pans with uneven bottoms are not suitable.



How to Set the Controls

1. Push the control knob in.
2. Turn either clockwise or counterclockwise to the desired heat setting.

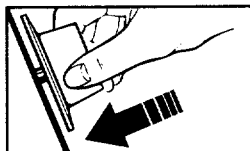

The control must be pushed in to set only from the OFF position. When the control is in any position other than OFF, it may be rotated without pushing in.

Be sure you turn control to OFF when you finish cooking.

An indicator light will glow when ANY heat on any surface unit is on.

Cooktop temperatures increases with the number of surface units that are on. With 3 or 4 surface units turned on, surface temperatures are high, so be careful when touching the cooktop.

Cooking Guide for Using Heat Settings

At both OFF and HI settings, there is a slight niche. When turning the control knob to either of these positions, you will feel the control “click” into the niche.

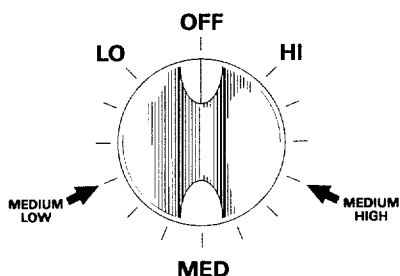

When cooking in a quiet kitchen, you may hear slight “clicking” sounds—an indication that the heat settings you selected are being maintained.

Switching heats to higher settings always results in a quicker change than switching to lower settings.

HI—Bring water to boil.

MEDIUM HI—Fast fry, pan broil; maintain fast boil on large amount of food.

MED—Saute and brown; maintain slow boil on large amount of food.

MEDIUM LO—Cook after starting at HI; cook with little water in covered pan.

LO—Steam rice, cereal; maintain serving temperature of most foods.

NOTE:

1. At HI or MEDIUM HI, never leave food unattended. Boilovers cause smoking; greasy spillovers may catch fire.
2. At LO or MEDIUM LO, melt chocolate, butter on small unit.

Sensi-Temp™ Control (on some models)

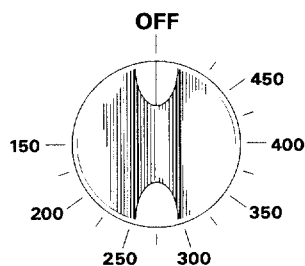

The automatic solid disk surface unit senses the temperature of the pan and regulates it according to the setting selected.

To turn the surface unit ON, **push in** and turn the knob counterclockwise. You will feel a “click” at the OFF position.

When turned on, the Sensi-Temp™ surface unit always begins with full power, no matter where the knob is set. When the temperature you selected has been reached, the surface unit cycles OFF and ON to maintain the setting automatically, similar to your oven. Even when the knob is set at minimum, the surface unit begins on full power until the selected heat setting is reached.

The Sensi-Temp™ surface unit will not burn food when the correct setting is selected. For example, beans, chocolate and mashed potatoes can be left on the Sensi-Temp™ surface unit without scorching or burning. Food may dehydrate if left on for long periods of time, but the heat sensing device will not let the food or pan overheat beyond the setting.

Lamp Over the Surface Unit (on some models)

Push the switch to turn the light on and off.

(continued next page)



SURFACE COOKING

(continued)

How to Check Pan Performance on a Solid Disk Surface Unit

1. Put 1 inch of water into the pan.
2. Bring water to a boil and observe the pattern of the bubbles as the water comes to a boil.
3. A uniform pattern of bubbles across the bottom of the pan confirms a good heat transfer and a good pan.
4. Bubbles localized in only a portion of the bottom indicate uneven contact of the pan to the surface unit, uneven heat transfer or an unsuitable pan.

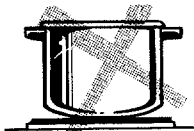

- Do not use pans with rounded bottoms. They don't have enough contact with the solid disk surface unit to cook properly.



- We recommend that you use only a flat-bottomed wok. They are available at your local retail store. The bottom of the wok should have the same diameter as the element to ensure proper contact.

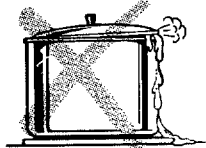

- Use pans of the correct diameter only. They should be slightly larger than the solid disk surface unit so spillovers will flow onto the cooktop and not bake onto the element. A damp cloth is sufficient to remove the spill. Pans should not overhang more than 1 inch beyond the surface unit.

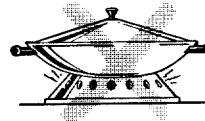

- Do not use woks that have support rings. This type of wok will not heat on solid disk surface units.

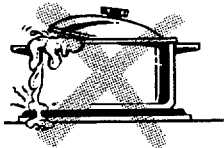

- To optimize cooking time and energy usage, you should use a pan that is sized correctly for the cooking process, with a well-fitted lid to avoid evaporation loss, and cook with as little water or fat as possible. If the pan is too small, energy is wasted and spillage can flow onto the solid disk surface unit.

- Some special cooking procedures require specific cookware such as pressure cookers, deep fat fryers, etc. All cookware must have flat bottoms and be the correct size. The cookware should also be covered, if applicable to the cooking process.

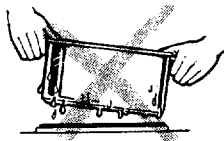

- Place only dry pans on the solid disk surface units. Do not place lids on the surface units, particularly wet lids.

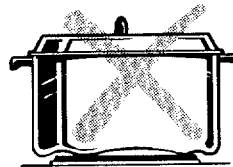

- Canning pots should not extend more than 1 inch beyond the surface of a solid disk surface units and should have flat bottoms. When canning pots do not meet this description, the use of the HI heat setting causes excessive heat buildup and may result in damage to the cooktop. See the Home Canning Tips section for further information.



Questions and Answers

Q. May I can foods and preserves on my solid disk surface units?

A. Yes, but only use cookware designed for canning purposes. Check the manufacturer's instructions and recipes for preserving foods. Be sure canner is flat-bottomed and fits over the center of the solid disk surface unit. Since canning generates large amounts of steam, be careful to avoid burns from steam or heat. Canning should only be done on the surface units. Follow our recommendations in the Home Canning Tips section.

Q. Why does the solid disk surface units smoke when I first turn it on?

A. This initial smoking is both normal and necessary. A rust preventative is applied to each surface unit at the factory. When the unit is turned on for the first time, the coating will burn off the surface unit areas. This takes approximately 5 minutes and should be done without any cookware on the surface unit. Otherwise, the coating will stick to the cookware.

Q. Why is the cooktop hot to the touch?

A. More heat is transferred to the cooktop by the solid disk surface units than by electric coil surface units because the surface units are clamped securely to the cooktop. This, of course, eliminates spillovers from getting inside the cooktop chassis. The secret to keeping the cooktop comfortably cooler is to turn the cooktop on only after the cookware and its contents are placed on the surface unit. More heat will then be transferred to the cookware and the food rather than the cooktop. The cooktop temperature will not cause damage to the cabinets, countertops or cookware.

Q. Why am I overcooking my food with the new solid disk surface units?

A. The solid disk surface units are very energy-efficient and retain heat much longer than the coil surface units. Food will boil or fry 3 to 5 minutes after the controls are turned off. We recommend that you begin cooking at lower settings than you have in the past and gradually increase or decrease heat as desired. The energy savings are significant.

Q. Why does it take a long time to cook my food?

A. It doesn't. The extra time it takes compared to the electric coil surface unit is measured in seconds, not minutes. These few seconds are due to the greater mass of the unit. If the food is cooking slowly, it is because the pots and pans are warped or have an uneven bottom surface. If flat-bottomed pots and pans are used, cooking performance of the solid disk surface unit closely parallels that of the coil surface unit with less energy consumption.

Q. Can I use special cooking equipment like an oriental wok, on my solid disk surface units?

A. We recommend that you use only a flat-bottomed wok. They are available at your local retail store. The bottom of the wok should have the same diameter as the surface unit to ensure proper contact. Do not use woks that have support rings. This type of wok will not heat on solid disk surface units.

Q. Why is the porcelain finish on my cookware coming off?

A. If you set your solid disk surface unit on a heat setting higher than required for the cookware material, and let the cookware sit too long, the cookware's finish may smoke, crack, pop or burn depending on the pot or pan. Also, cooking small amounts of dry food may damage the cookware's finish.



HOME CANNING TIPS

Canning should be done on the solid disk surface unit's only.

Pots that extend beyond one inch of a cooking unit's trim ring are not recommended for most surface cooking. However, when canning with a water-bath or pressure canner, larger-diameter cookware may be used. This is because boiling water temperatures (even under pressure) are not harmful to cooktop surfaces surrounding the cooking units.

HOWEVER, DO NOT USE LARGE DIAMETER CANNERS OR OTHER LARGE DIAMETER POTS FOR FRYING OR BOILING FOODS OTHER THAN WATER. Most syrup or sauce mixtures—and all types of frying—cook at temperatures much higher than boiling water. Such temperatures could eventually harm cooktop surfaces surrounding the solid disk surface units.

Observe the Following Points in Canning

1. Be sure the canner fits over the center of the cooking unit. If your range or its location does not allow the canner to be centered on the cooking unit, use smaller-diameter pots for good canning results.
2. Flat-bottomed canners must be used. Do not use canners with flanged or rippled bottoms (often found in enamelware) because they don't make enough contact with the solid disk surface unit and take too long to boil water.



Flat-bottomed canners are recommended.

3. When canning, use recipes and procedures from reputable sources. Reliable recipes and procedures are available from the manufacturer of your canner; manufacturers of glass jars for canning, such as Ball and Kerr; and the United States Department of Agriculture Extension Service.
4. Remember that canning is a process that generates large amounts of steam. To avoid burns from steam or heat, be careful when canning.

NOTE: If your house has low voltage, canning may take longer than expected, even though directions have been carefully followed. The process time will be shortened by:

- (1) using a pressure canner, and
- (2) starting with **HOT** tap water for fastest heating of large quantities of water.

CAUTION:

Safe canning requires that harmful microorganisms are destroyed and that the jars are sealed completely. When canning foods in a water-bath canner, a gentle but steady boil must be maintained continuously for the required time. When canning foods in a pressure canner, the pressure must be maintained continuously for the required time.

Solid disk surface units heat up and cool down more slowly than other electric surface units. Because of this difference, after you have adjusted the controls, it is very important to make sure the prescribed boil or pressure levels are maintained for the required time.

The solid disk surface units have temperature limiters that help prevent damage to the cooktop. If the bottom of your canner is not flat, the solid disk surface unit can overheat, triggering the temperature limiters to turn the unit off for a time. This will stop the boil or reduce the pressure in the canner.

Since you must make sure to process the canning jars for the prescribed time, with no interruption in processing time, you cannot can on solid disk surface units if the bottom of your canner is not flat enough.

FEATURES OF YOUR OVEN CONTROL

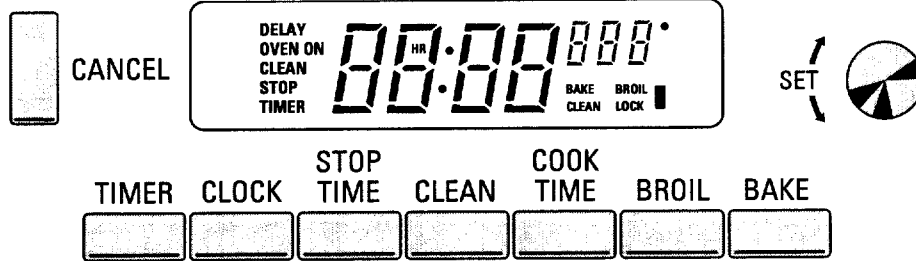

Oven "On" Indicator

The word "ON" is displayed when the BAKE or the BROIL button is pushed. It goes out when the oven CANCEL button is pushed or when the oven shuts off automatically.

The oven operation is controlled electronically. The following instructions tell you how to operate the electronic controls.

To Set the Clock

1. Push the CLOCK button.
2. Turn the SET knob to the correct time of day. The clock is now set. The clock must be set to the correct time of day for accurate automatic oven timing operations.

To Set the Minute/Second Timer

1. Push the TIMER button.
2. Turn the SET knob to the desired amount of time (up to 9 hours and 59 minutes). The minute/second timer will begin to count down within a few seconds.
3. When time is up, the end of cycle tone (3 long beeps) will sound and the display will again show the time of day.

To Cancel the Timer

Push and hold the TIMER button for 3 seconds while "TIMER" is displayed. This will clear the minute/second timer function.

NOTE: The minute/second timer is a reminder only and will not operate the oven.

You can use the minute/second timer whether or not the oven is being used. The minute/second timer does not interfere with oven operations.

Tones

End-of-Cycle Tone (3 long beeps—1 second on, 1 second off): shows that a timed oven operation has reached the Stop Time or that the minute/second timer has counted down.

Attention Tone (series of short beeps, 1/4-second on, 1/4-second off, until the proper response is given): will sound if the oven has only been partially programmed. For example, if you have selected a cook time but no temperature, you will hear the attention tone until you select a temperature or push the CANCEL button.

Notification Tone (single, 1-second beep): indicates the oven has stabilized at the selected temperature.

Key Tone (single, 1/10-second beep): sounds when any button is pushed.

Function Error Tone (series of very rapid beeps, 1/8-second on, 1/4-second off): display will show a code. Cancel the function error tone by pushing the CANCEL button. If the function error tone starts again (after about 15 seconds), call for service. Disconnect the range electrical supply to stop the tone.

If the function error occurred while you were programming the oven control, push the CANCEL button and try again.

To Cancel the Tone... If you don't want an audible tone when you push a button, you can eliminate the Key Tone by pushing and holding the CANCEL button until you hear a short beep (in approximately two seconds). To activate the tone again, push and hold the CANCEL button once more until you hear a short beep. Cancelling or activating the tone should only be done when there is no oven operation programmed.

Pushing the CANCEL button will clear all functions except the Clock and Minute/Second Timer.



USING YOUR OVEN

Before Using Your Oven

1. Look at the controls. Be sure you understand how to set them properly. Read over the directions for the Oven Controls so you understand how to use them.
2. Check oven interior. Look at the shelves. Take a practice run at removing and replacing them properly, to give sure, sturdy support.
3. Read over information and tips that follow.
4. Keep this book handy so you can refer to it, especially during the first weeks of using your new range.

NOTE: You may notice a “burning” or “oily” smell the first few times you turn your oven on. This is normal in a new oven and will dissipate in a short time. To speed the process, set a self-clean cycle (see Operating the Self-Cleaning Oven section) lasting a minimum of 3 hours.

Oven Shelves

The shelves are designed with stop-locks so when placed correctly on the shelf supports, they will stop before coming completely out of the oven and will not tilt when you are removing food from them or placing food on them.

When placing cookware on a shelf, pull the shelf out to the “stop” position. Place the cookware on the shelf, then slide the shelf back into the oven. This will eliminate reaching into the hot oven.

To remove the shelf from the oven, pull it toward you, tilt the front end upward, and pull it out.

To replace, place the shelf on the shelf support with the stop-locks (curved extension of the shelf) facing up and toward the rear of the oven. Tilt up the front and push the shelf toward the back of the oven until it goes past “stop” on the oven wall. Then lower the front of the shelf and push it all the way back.

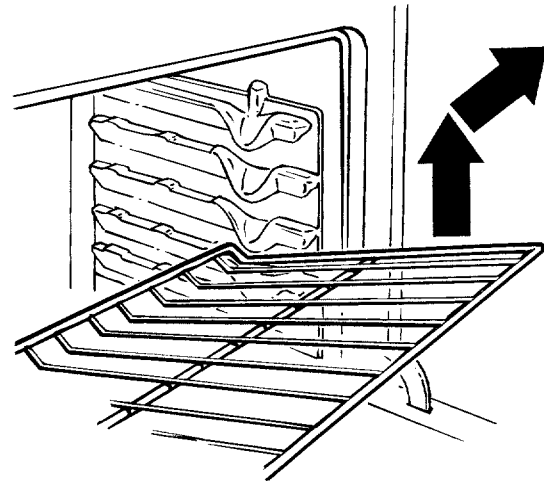

Shelf Positions

The oven has 4 shelf supports identified in this illustration as A (bottom), B, C and D (top).

Shelf positions for cooking are suggested in the Baking, Roasting and Broiling sections.

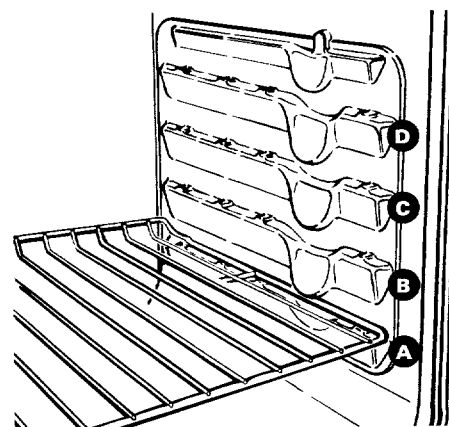



Oven Light

The light comes on automatically when the door is opened.
Use the switch on the control panel to turn the light on and off when the door is closed.

Do It Yourself—Adjust the Oven Thermostat

If you don't think the oven is heating at the right temperature when you are baking or roasting, you can reset the thermostat yourself.

When cooking food for the first time in your new oven, use time given on recipes as a guide. Oven thermostats, over a period of years, may "drift" from the factory setting and the differences in timing between an old and a new oven of 5 to 10 minutes are not unusual. Your oven has been set correctly at the factory and is more likely to be accurate than the oven which it replaced.

We do not recommend the use of inexpensive thermometers, such as those found in the grocery store, to check the temperature setting of your new oven. These thermometers can vary by 20–40 degrees.

To decide how much to change the temperature, set the oven temperature 25°F. higher or lower than the temperature in your recipe, then bake. The results of this "test" should give you an idea of how much the temperature should be changed.

To Adjust the Temperature:

BAKE 1. Push the BAKE button.



2. Select an oven temperature between 500°F. and 550°F. with the SET knob.

3. Immediately, before "BAKE" appears, push and hold the BAKE button for about 4 seconds. The time display will change to the oven adjustment display.

4. The oven temperature can be adjusted up to (+) 35°F. hotter or (–) 35°F. cooler.



Turn the SET knob to adjust the temperature in 5°F. increments.

If the oven control signals, push the CANCEL button and start over.



CANCEL

5. When you have made the adjustment, push the CANCEL button to go back to the time of day display. Use your oven as you would normally.

NOTE: This adjustment will not affect the Broil or Clean temperatures. It will be retained in memory after a power failure.

BAKING

Do not lock the oven door with the latch during baking. The latch is used for self-cleaning only.

Your oven temperature is controlled very accurately using an oven control system. We recommend that you operate the range for a number of weeks using the time given on recipes as a guide to become familiar with your new oven's performance. If you think an adjustment is necessary, see the *Do It Yourself—Adjust the Oven Temperature* section.

(continued next page)



BAKING

(continued)

How to Set Your Range for Baking

To avoid possible burns, place the shelves in the correct position before you turn the oven on.

BAKE 1. Push the BAKE button.



2. Turn the SET knob until the desired temperature is displayed.

If preheating is desired, do not place the food in the oven until the 1-second beep sounds to indicate the oven is preheated.



CANCEL

3. Push the CANCEL button when baking is finished and then remove the food from the oven.

To change the oven temperature during the bake cycle, push the BAKE button and then turn the SET knob to get the new temperature.

TIMED BAKING

How to Time Bake

Do not lock the oven door with the latch during timed baking. The latch is used for self-cleaning only.

The oven control allows you to turn the oven on or off automatically at specific times that you set.

NOTE: Before beginning make sure the oven clock shows the correct time of day.

CLOCK

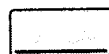

To set the clock, first push the CLOCK pad. Turn the SET knob until the correct time of day is displayed.

How to Set Immediate Start and Automatic Stop

To avoid possible burns, place the shelves in the correct position before you turn the oven on.

The oven will turn on immediately and cook for a selected length of time. At the end of Cook Time, the oven will turn off automatically.

COOK TIME 1. Push the COOK TIME button.



2. Turn the SET knob until the desired length of baking time appears in the display.

BAKE 3. Push the BAKE button.



4. Turn the SET knob until the desired temperature is displayed.

The oven will continue to cook for the programmed amount of time, then shut off automatically.

5. Remove the food from the oven. **Remember,** even though the oven shuts off automatically, foods continue cooking after the controls are off.

NOTE:

- Foods that spoil easily such as milk, eggs, fish, stuffings, poultry and pork should not be allowed to sit for more than 1 hour before or after cooking. Room temperature promotes the growth of harmful bacteria. Be sure the oven light is off because heat from the bulb will speed harmful bacteria growth.
- Push the STOP TIME button to find out when the end of cycle tone will sound and the oven will turn off.
- Push the CLOCK button to display the time of day with out cancelling the oven operation.



How to Set Delay Start and Automatic Stop

Quick Reminder:

1. Push the COOK TIME button.
2. Turn the SET knob to set the cooking time.
3. Push the STOP TIME button.
4. Turn the SET knob until the desired stop time appears in the display.
5. Push the BAKE button.
6. Turn the SET knob to select the oven temperature.

To avoid possible burns, place the shelves in the correct position before you turn the oven on.

You can set the oven control to turn the oven on automatically, cook for a specific length of time and turn off automatically.

For example: Let's say it's 2:00 and dinner time is shortly after 7:00. The recipe suggests 3 hours baking time at 325°F. Here's how:

- COOK TIME** 1. Push the COOK TIME button.

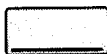

2. For 3 hours of cooking time, turn the SET knob until "3:00" appears in the display.

- STOP TIME** 3. Push the STOP TIME button.

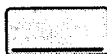

4. Set the Stop Time by turning the SET knob until "7:00" appears in the display.

- BAKE** 5. Push the BAKE button.



6. Turn the SET knob until "325°" is displayed.

At 4:00, the oven will turn on automatically. The oven will continue to cook for the programmed 3 hours and shut off automatically at 7:00.

7. Remove the food from the oven. Remember, even though the oven shuts off automatically, foods continue cooking after the controls are off.

NOTE:

- The low temperature zone of this range (between 150°F. and 200°F.) is available to keep hot cooked foods warm. Food kept in the oven longer than 2 hours at these low temperatures may spoil.
- When setting your oven for a delay start, never let foods such as dairy products, fish, meat, poultry, etc. sit for more than 1 hour before actual cooking begins. Room temperature promotes the growth of harmful bacteria. Be sure the oven light is off because heat from the bulb will speed bacteria growth.

(continued next page)



BAKING

(continued)

For best baking results, follow these suggestions:

Oven Shelves

Arrange the oven shelf or shelves in the desired locations while the oven is cool. The correct shelf position depends on the kind of food and the browning desired. As a general rule, place most foods in the middle of the oven, on either shelf position B or C. See the chart for suggested shelf positions.

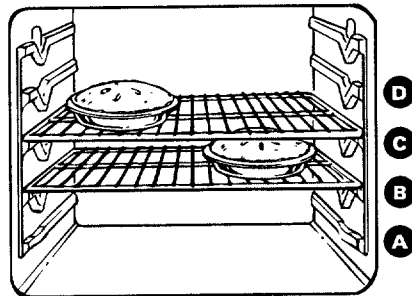

Type of Food	Shelf Position
Angel food cake	A
Biscuits or muffins	B or C
Cookies or cupcakes	B or C
Brownies	B or C
Layer cakes	B or C
Bundt or pound cakes	A or B
Pies or pie shells	B or C
Frozen pies	A (on cookie sheet)
Casseroles	B or C
Roasting	A or B

Preheating

Preheat the oven if the recipe calls for it. Preheat means bringing the oven up to the specified temperature before putting in the food. To preheat, set the oven at the correct temperature—selecting a higher temperature does not shorten preheat time.

Preheating is necessary for good results when baking cakes, cookies, pastry and breads. For most casseroles and roasts, preheating is not necessary. For ovens without a preheat indicator light or tone, preheat 10 minutes. After the oven is preheated place the food in the oven as quickly as possible to prevent heat from escaping.

Baking Pans

Use the proper baking pan. The type of finish on the pan determines the amount of browning that will occur.

- Dark, rough or dull pans absorb heat resulting in a browner, crisper crust. Use this type for pies.
- Shiny, bright and smooth pans reflect heat, resulting in a lighter, more delicate browning. Cakes and cookies require this type of pan.
- Glass baking dishes also absorb heat. When baking in glass baking dishes, lower the temperature by 25°F. and use the recommended cooking time in the recipe. This is not necessary when baking pies or casseroles.

Pan Placement

For even cooking and proper browning, there must be enough room for air circulation in the oven. Baking results will be better if baking pans are centered as much as possible rather than being placed to the front or to the back of the oven.

Pans should not touch each other or the walls of the oven. Allow 1 to 1½ inch space between pans as well as from the back of the oven, the door and the sides. If you use 2 shelves, stagger the pans so 1 is not directly above the other.



Baking Guides

When using prepared baking mixes, follow package recipe or instructions for the best baking results.

Cookies

When baking cookies, flat cookie sheets (without sides) produce better-looking cookies. Cookies baked in a jelly roll pan (short sides all around) may have darker edges and pale or light browning may occur.

Do not use a cookie sheet so large that it touches the walls or the door of the oven. Never entirely cover a shelf with a large cookie sheet.

For best results, use only 1 cookie sheet in the oven at a time.

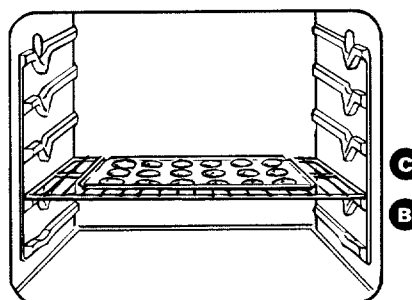

Pies

For best results, bake pies in dark, rough or dull pans to produce a browner, crisper crust. Frozen pies in foil pans should be placed on an aluminum cookie sheet for baking since the shiny foil pan reflects heat away from the pie crust; the cookie sheet helps retain it.

Cakes

When baking cakes, warped or bent pans will cause uneven baking results and poorly shaped products. A cake baked in a pan larger than the recipe recommends will usually be crisper, thinner and drier than it should be. If baked in a pan smaller than recommended, it may be undercooked and batter may overflow. Check the recipe to make sure the pan size used is the one recommended.

Aluminum Foil

Never entirely cover a shelf with aluminum foil. This will disturb the heat circulation and result in poor baking. A smaller sheet of foil may be used to catch a spillover by placing it on a lower shelf several inches below the food.

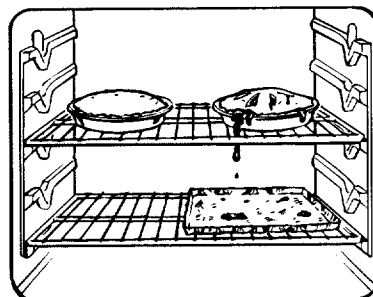

Don't Peek

Set the timer for the estimated cooking time and do not open the door to look at your food. Most recipes provide minimum and maximum baking times such as "bake 30-40 minutes."

DO NOT open the door to check until the minimum time. Opening the oven door frequently during cooking allows heat to escape and makes baking times longer. Your baking results may also be affected.



ROASTING

Do not lock the oven door with the latch during Roasting. The latch is used for self-cleaning only.

Roasting is cooking by dry heat. Tender meat or poultry can be roasted uncovered in your oven. Roasting temperatures, which should be low and steady, keep spattering to a minimum.

Roasting is really a baking procedure used for meats. Therefore, the oven controls are set for BAKE or Timed Baking. You may hear a slight clicking sound, indicating the oven is working properly. Roasting is easy; just follow these directions:

1. Place the shelf in A or B position. No preheating is necessary.

2. Check the weight of the meat. Place the meat fat-side-up, or poultry breast-side-up, on roasting rack in a shallow pan. The melting fat will baste the meat. Select a pan as close to the size of the meat as possible. (The broiler pan with rack is a good pan for this.) Line the broiler pan with aluminum foil when using pan for marinating, cooking with fruits, cooking heavily cured meats, or basting food during cooking. Avoid spilling these materials inside the oven or inside the oven door.

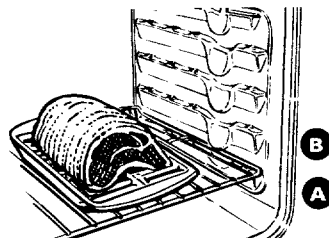

BAKE 3. Push the BAKE button.



4. Turn the SET knob until the desired temperature is displayed.



CANCEL

5. Push the CANCEL button when cooking or roasting is finished and then remove the food from the oven.

Most meats continue to cook slightly while standing, after being removed from the oven. Standing time recommended for roasts is 10 to 20 minutes. This allows roasts to firm up and makes them easier to carve. Internal temperature will rise about 5° to 10°F.; to compensate for temperature rise, if desired, remove the roast from oven sooner (at 5° to 10°F. less than temperature in the Roasting Guide).

NOTE: You may wish to use Timed Baking, as described in the Baking section of this book, to turn the oven on and off automatically.

To change the oven temperature during the roasting cycle, push the BAKE button and then turn the SET knob to get the new temperature.

For Frozen Roasts

Frozen roasts of beef, pork, lamb, etc., can be started without thawing, but allow 10 to 25 minutes per pound additional time (10 minutes per pound for roasts under 5 pounds, more time for larger roasts).

Thaw most frozen poultry before roasting to ensure even doneness. Some commercial frozen poultry can be cooked successfully without thawing. Follow the directions given on the package label.



Questions and Answers

Q. Is it necessary to check for doneness with a meat thermometer?

A. Checking the finished internal temperature at the completion of cooking time is recommended. Temperatures are shown in the Roasting Guide section. For roasts over 8 lbs., check with thermometer at half-hour intervals after half the cooking time has passed.

Q. Why is my roast crumbling when I try to carve it?

A. Roasts are easier to slice if allowed to cool 10 to 20 minutes after removing them from the oven. Be sure to cut across the grain of the meat.

Q. Do I need to preheat my oven each time I cook a roast or poultry?

A. It is unnecessary to preheat your oven.

Q. When buying a roast, are there any special tips that would help me cook it more evenly?

A. Yes. Buy a roast as even in thickness as possible, or buy rolled roasts.

Q. Can I seal the sides of my foil "tent" when roasting a turkey?

A. Sealing the foil will steam the meat. Leaving it unsealed allows the air to circulate and brown the meat.

ROASTING GUIDE

Type	Oven Temperature	Doneness	Approximate Roasting Time in Minutes per Pound		Internal Temperature °F.
Meat Tender cuts; rib, high quality sirloin tip, rump or top round*	325°	Rare: Medium: Well Done:	3 to 5 lbs. 24-33 35-39 40-45	6 to 8 lbs. 18-22 22-29 30-35	140°-150°† 150°-160° 170°-185°
Lamb leg or bone-in shoulder*	325°	Rare: Medium: Well Done:	21-25 25-30 30-35	20-23 24-28 28-33	140°-150°† 150°-160° 170°-185°
Veal shoulder, leg or loin*	325°	Well Done:	35-45	30-40	170°-180°
Pork loin, rib or shoulder*	325°	Well Done:	35-45	30-40	170°-180°
Ham, precooked	325°	To Warm:	17-20 minutes per pound (any weight)		115°-125°
Poultry Chicken or Duck	325°	Well Done:	3 to 5 lbs. 35-40	Over 5 lbs. 30-35	185°-190°
Chicken pieces	350°	Well Done:	35-40		185°-190°
Turkey	325°	Well Done:	10 to 15 lbs. 18-25	Over 15 lbs. 15-20	In thigh: 185°-190°

*For boneless rolled roasts over 6 inches thick, add 5 to 10 minutes per pound to times given above.

†The U. S. Department of Agriculture says "Rare beef is popular, but you should know that cooking it to only 140°F. means some food poisoning organisms may survive." (Source: Safe Food Book, Your Kitchen Guide. USDA Rev. June 1985.)



BROILING

Do not lock the oven door with the latch during broiling. The latch is used for self-cleaning only.

Broiling is cooking food by intense radiant heat from the upper unit in the oven. Most fish and tender cuts of meat can be broiled. Follow these directions to keep spattering and smoking to a minimum.

1. If the meat has fat or gristle near edge, cut vertical slashes through both about 2" apart. If desired, fat may be trimmed, leaving layer about 1/8" thick.
2. Place the meat on the broiler rack on the broiler pan which comes with the range. Always use the rack so the fat drips into the broiler pan; otherwise the juices may become hot enough to catch fire.
3. Position the shelf on the recommended shelf position as suggested in the Broiling Guide.

4. **Leave the door open to the broil stop position.**
The door stays open by itself, yet proper temperature is maintained in the oven.

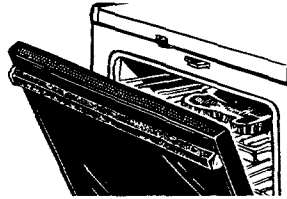

BROIL 5. Push the BROIL button.



6. Turn the SET knob until either HI BROIL or LO BROIL is displayed.

7. Turn food only once during cooking. Time foods for first side according to the Broiling Guide.

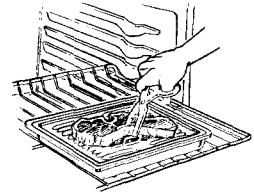

Turn food, then use times given for second side as a guide to preferred doneness. (Where 2 thicknesses and times are given together, use first times given for thinnest food.)



CANCEL

8. When broiling is completed push the CANCEL button. Serve the food immediately, and leave the pan outside the oven to cool during the meal for easiest cleaning.

Use of Aluminum Foil

You can use aluminum foil to line your broiler pan and broiler rack. However, you must mold the foil tightly to the rack and cut slits in it just like the rack.

Without the slits, the foil will prevent fat and meat juices from draining to the broiler pan. The juices could become hot enough to catch on fire. If you do not cut the slits, you are frying, not broiling.

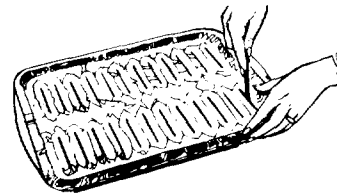

Questions & Answers

Q. When broiling, is it necessary to always use a rack in the pan?

A. Yes. Using the rack suspends the meat over the pan. As the meat cooks, the juices fall into the pan, thus keeping meat drier. Juices are protected by the rack and stay cooler, thus preventing excessive spatter and smoking.

Q. Do I need to grease my broiler rack to prevent meat from sticking?

A. No. The broiler rack is designed to reflect broiler heat, thus keeping the surface cool enough to prevent meat from sticking to the surface. However, spraying the broiler rack lightly with a vegetable cooking spray before cooking will make cleanup easier.

Q. Should I salt the meat before broiling?

A. No. Salt draws out the juices and allows them to evaporate. Always salt after cooking. Turn meat with tongs; piercing meat with a fork also allows juices to escape. When broiling poultry or fish, brush each side often with butter.

Q. Why are my meats not turning out as brown as they should?

A. In some areas, the power (voltage) to the range may be low. In these cases, preheat the broil unit for 10 minutes before placing broiler pan with food in oven. Check to see if you are using the recommended shelf position. Broil for longest period of time indicated in the Broiling Guide. Turn food only once during broiling.

BROILING GUIDE

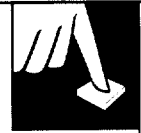

1. Always use the broiler pan and rack that comes with your range. It is designed to minimize smoking and spattering by trapping juices in the shielded lower part of the pan.
2. Leave the oven door open to the broil stop position for all foods.
3. For steaks and chops, slash fat evenly around outside edges of meat. To slash, cut crosswise through outer fat surface just to the edge of the meat. Use tongs to turn meat over to prevent piercing meat and losing juices.
4. If desired, marinate meats or chicken before broiling, or brush with barbecue sauce last 5 to 10 minutes only.
5. When arranging food on the pan, do not let fatty edges, which could soil oven with fat dripping, hang over the sides.
6. The broiler does not need to be preheated. However, for very thin foods, or to increase browning, preheat if desired.
7. Frozen steaks can be broiled by positioning the oven shelf at next lowest shelf position and increasing cooking time given in this guide 1½ times per side.
8. If your range is connected to 208 volts, rare steaks may be broiled by preheating the broiler and positioning the oven shelf 1 position higher.

Food	Quantity and/or Thickness	Shelf Position	First Side Time, Minutes	Second Side Time, Minutes	Comments
Bacon	1/2 lb. (about 8 thin slices)	C	4½	4½	Arrange in single layer.
Ground Beef Well Done	1 lb. (4 patties) 1/2 to 3/4 inch thick	C	10	7	Space evenly. Up to 8 patties take about same time.
Beef Steaks					
Rare	1 inch thick	C	6	5	Steaks less than 1 inch thick cook through before browning. Pan frying is recommended.
Medium	(1 to 1½ lbs.)	C	8	6	
Well Done		C	12	11	
Rare	1½ inch thick	C	10	7-8	Slash fat.
Medium	(2 to 2½ lbs.)	C	15	14-16	
Well Done		C	25	20-25	
Chicken	1 whole (2 to 2½ lbs.), split lengthwise	A	35	10-15	Reduce time about 5 to 10 minutes per side for cut-up chicken. Brush each side with melted butter. Broil skin-side-down first.
Bakery Products					
Bread (Toast) or Toaster Pastries	2 to 4 slices	C	1½-2	1/2	Space evenly. Place English muffins cut-side-up and brush with butter, if desired.
English Muffins	1 pkg. (2) 2 (split)	C		3-4	
Lobster Tails	2-4 (6 to 8 oz. each)	B	13-16	Do not turn over.	Cut through back of shell. Spread open. Brush with melted butter before broiling and after half of broiling time.
Fish	1-lb. fillets 1/4 to 1/2 inch thick	C	5	5	Handle and turn very carefully. Brush with lemon butter before and during cooking, if desired. Preheat broiler to increase browning.
Ham Slices (precooked)	1 inch thick	B	8	8	Increase time 5 to 10 minutes per side for 1½ inch thick or home cured ham.
Pork Chops Well Done	2 (1/2 inch thick) 2 (1 inch thick), about 1 lb.	C B	10 13	10 13	Slash fat.
Lamb Chops					
Medium	2 (1 inch thick)	C	10	9	Slash fat.
Well Done	about 10 to 12 oz.	C	12	10	
Medium	2 (1½ inch thick), about 1 lb.	C B	14 17	12 12-14	
Wieners and similar precooked sausages, bratwurst	1-lb. pkg. (10)	C	6	1-2	If desired, split sausages in half lengthwise; cut into 5-to 6-inch pieces.



OPERATING THE SELF-CLEANING OVEN

Normal Cleaning Time: 3 hours

Before a Clean Cycle

The range must be completely cool in order to set the self-clean cycle. You may have to allow the oven to cool before you can slide the door latch.

1. Remove the broiler pan, broiler rack, all cookware and any aluminum foil from the oven—they cannot withstand the high cleaning temperatures.

NOTE: The oven shelves may be left in oven. Shelves will discolor and become hard to slide after the self-clean cycle.

2. Wipe up heavy soil on the oven bottom. If you use soap, rinse thoroughly before self-cleaning to prevent staining.

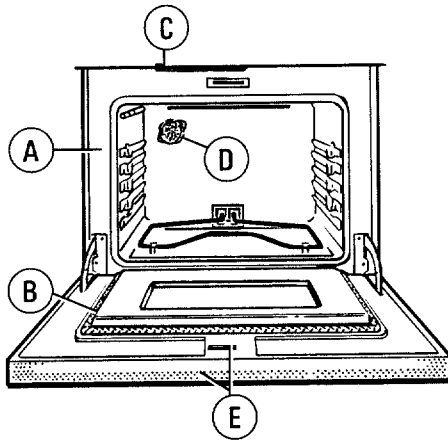

- A. Oven Front Frame
- B. Oven Door Gasket
- C. Oven Door Latch
- D. Oven Light
- E. Openings in Door.

3. Clean spatters or spills on oven front frame (A), under the front edge of the oven vent, the door liner outside the door gasket and the front edge of the oven cavity (about 1 inch into the oven). Use detergent and hot water with a soap-filled steel wool pad, then rinse well with a vinegar and water mixture. This will help prevent a brown residue from forming when the oven is heated. Buff these areas with a dry cloth.

- **Do not rub or clean the door gasket (C)**—the fiberglass material of the gasket has an extremely low resistance to abrasion. An intact and well-fitting oven door gasket is essential for energy-efficient oven operation and good baking results. If you notice the gasket becoming worn, frayed or damaged in any way or if it has become displaced on the floor, you should have it replaced.
- **Do not let water run down through openings in top of door (E).** To help prevent water from getting in these slots when cleaning, open the door as far as it will go.
- 4. Close the door and make sure the oven light (D) is off. If the oven light is not turned off, the life of the bulb will be shortened or it may cause the bulb to burn out immediately.

The oven shelves may be cleaned in the self-cleaning oven. However, they will darken, lose their luster and become hard to slide. Wipe the shelf supports with cooking oil after self-cleaning to make shelves slide more easily.

Do not use commercial oven cleaners or oven protectors in or near the self-cleaning oven. A combination of any of these products plus the high clean cycle temperatures may damage the porcelain finish of the oven.

Important

The oven door must be closed, latched and all controls must be set correctly for the clean cycle to work properly.



How to Set Oven for Cleaning

Quick Reminder:

1. Prepare the oven for cleaning.
2. Close and latch the oven door.
3. Push the CLEAN button.
4. Turn the SET knob to set the clean time.

1. Follow the steps to prepare the oven for cleaning.
2. Close the oven door and slide latch handle to the right as far as it will go.

Never force the door latch handle. Forcing the handle may damage the door lock mechanism.

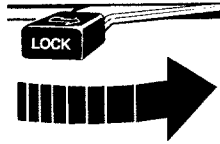

- CLEAN 3. Push the CLEAN button.

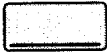

4. Turn the SET knob one half turn. The display will show "3:30".

The self-clean cycle will automatically begin after "CLEAN" is displayed and the word "ON" appears on the display. When the oven heats to a high temperature, the word "LOCK" will be displayed and the door latch handle will be locked in position. It will not be possible to open the oven door until the LOCK light goes off and the oven has cooled below locking temperature. If you cannot slide the latch easily to unlock the door, allow additional time for cooling.

The word "DOOr" is displayed if you try to set a clean cycle without latching the door or if the oven temperature is too high.

After a Clean Cycle

When the clean cycle is finished, the word "CLEAN" will go out in the display and the oven will begin to cool. When the oven temperature has fallen below the locking temperature, the word "LOCK" goes out and the door can be opened.

When the LOCK light is off and the oven has cooled below the locking temperature, slide latch handle to the left as far as it will go and open the door.

Never force the latch handle. The latch slides easily. Forcing the latch handle may damage the door lock.

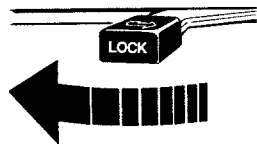

After a clean cycle, you may notice some white ash in the oven. Just wipe it up with a damp cloth.

If white spots remain, remove them with a soap-filled steel wool pad. Be sure to rinse thoroughly with a vinegar and water mixture. These deposits are usually a salt residue that cannot be removed by the clean cycle.

If the oven is not clean after 1 clean cycle, the cycle may be repeated.

(continued next page)



OPERATING THE SELF-CLEANING OVEN

(continued)

How to Set Delay Start of Cleaning

Delay Start is setting the oven timer to start the clean cycle automatically at a later time than the present time of day.

NOTE: Before beginning make sure the oven clock shows the correct time of day.

Quick Reminder—Delay Start for Self-Clean:

1. Prepare the oven for cleaning.
2. Close and latch the oven door.
3. Push the STOP TIME button.
4. Turn the SET knob to the time of day you want cleaning to be completed.
5. Push the CLEAN button.
6. Turn the SET knob one half turn until “3:30” appears in the display.

For example: Let's say it's 7:00 and you want the oven to begin self-cleaning at 9:00 after you're finished in the kitchen. The oven is just soiled a normal amount so the normal Clean Time of 3 hours is preferred.

1. Prepare the oven for cleaning.

2. Close the oven door and slide latch handle to the right as far as it will go. Make sure the oven light is off.

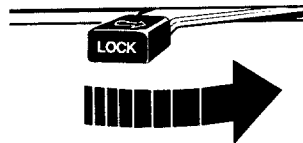

STOP
TIME



3. Push the STOP TIME button.



4. Turn the SET knob to the time of day you want cleaning to be completed (must be more than 3½ hours later than the present time of day).

CLEAN



5. Push the CLEAN button.



7. Turn the SET knob until “3:30” appears in the display. The words “DELAY CLEAN” will also appear in the display.

After the clean cycle starts, the word “CLEAN” will be on in the display.

When the oven heats to a high temperature, the word “LOCK” will be displayed and the door latch handle will be locked in position. It will not be possible to open the oven door until the temperature drops below the lock temperature.

When the clean cycle is finished, the word “CLEAN” will go out in the display and the oven will begin to cool. When the oven temperature has fallen below the locking temperature the word “LOCK” goes out and the door can be opened.

8. When the LOCK light is off, slide handle to the left as far as it will go and open the door.

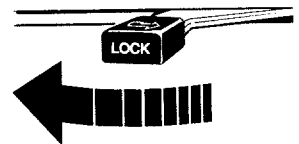

Never force the latch handle. Wait until the word “LOCK” goes out in the display and the latch slides easily. Forcing the door handle may damage the door lock.

NOTE: During a delayed self-clean operation, you can find out when the oven will start cleaning by pushing and holding the CLEAN button.

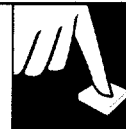

Questions and Answers

Q. If my oven clock is not set to the correct time of day, can I still self-clean my oven?

A. If the clock is not set to the correct time of day you will not be able to set a delay clean to end at a specific time.

Q. Can I use commercial oven cleaners on any part of my self-cleaning oven?

A. No cleaners or coatings should be used around any part of this oven. If you do use them and do not thoroughly rinse the oven with water, wiping it absolutely clean afterwards, the residue can scar the oven surface and damage metal parts the next time the oven is automatically cleaned.

Q. What should I do if excessive smoking occurs during cleaning?

A. This is caused by excessive soil. Push the CANCEL button. Open windows to rid room of smoke. Wait until the oven has cooled and the word "LOCK" is off in the display. Wipe up the excess soil and reset the clean cycle.

Q. Is the "crackling" or "popping" sound I hear during cleaning normal?

A. Yes. This is the sound of the metal heating and cooling during both the cooking and cleaning functions.

Q. Should there be any odor during the cleaning?

A. Yes, there may be an odor during the first few cleanings. Failure to wipe out excessive soil might also cause a strong odor when cleaning.

Q. What causes the hair-like lines on the enameled surface of my oven?

A. This is a normal condition, resulting from heating and cooling during cleaning. These lines do not affect how your oven performs.

Q. The word "DOOr" appeared on the display when I selected the Clean Cycle. What's wrong?

A. The door latch handle must be moved all the way to the right. Move the latch handle and cleaning will start.

Q. Why do I have ash left in my oven after cleaning?

A. Some types of soil will leave a deposit which is ash. It can be removed with a damp sponge or cloth.

Q. My oven shelves do not slide easily. What is the matter?

A. After self-cleaning, oven shelves may become so clean they do not slide easily. To make shelves slide more easily, after each self-cleaning dampen fingers with a small amount of cooking oil and rub lightly over sides of shelf where they contact shelf supports.

Q. My oven shelves have become gray after the self-clean cycle. Is this normal?

A. Yes. After the self-clean cycle, the shelves may lose some luster and discolor to a deep gray color.

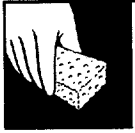

CARE AND CLEANING

Proper care and cleaning are important so your range will give you efficient and satisfactory service.

Follow these directions carefully in caring for your cooktop to assure safe and proper maintenance.

BE SURE THAT ELECTRIC POWER IS OFF BEFORE CLEANING ANY PART OF THE RANGE.

Removal of Packaging Tape

The safest way to remove adhesive left from packing tape on new appliances to assure no damage is done to the finish of the product is an application of a household liquid dishwashing detergent, mineral oil or cooking oil. Apply with a soft cloth and allow to soak. Wipe dry and then apply an appliance polish to thoroughly clean and protect the surface. This procedure is also safe for the face of microwave doors and other plastic and Lexan parts.

NOTE: The plastic tape that is not removed from the chrome trim on oven parts cannot be removed if baked on.

Glass Top

Wipe the glass cooktop clean after each use. Use an all-purpose, non-abrasive cleaner. Do not use a dish towel or sponge to wipe up the cooktop. They may leave a film of detergent which can discolor your cooktop when heated. If this happens, remove the film with the recommended cleaner. We recommend that you use paper towels or a clean cloth which is used only for cleaning the cooktop.

For burned on spillover:

- Remove excess soil with a razor scraper. Wearing an oven mitt, hold the scraper at a 30° angle to the cooktop and scrape off the soil. Be sure to use a new, sharp razor scraper. Do not use a dull or nicked blade.

NOTE:

- Using a razor scraper will not damage the surface if the 30° angle is maintained. Store the razor scraper out of reach of children.
- Scrub the glass cooktop with an all-purpose, non-abrasive cleaner, such as Bon Ami® brand, or with a cooktop cleaning creme. Rinse well and wipe dry. Cook Top Cleaning Creme is available at your GE Appliance and Parts Stores, Part No. WB64X5020.
- Never use abrasive scouring pads or powders on the glass cooktop. Plastic mesh pads such as Dobie® brand may be used.

Solid Disk Surface Units

The solid disk surface units are made of high strength cast-iron alloy.

The surface has a heat-resistant coating to preserve the surface of the unit. After the unit cools, any boiled-over material on them should be removed as soon as possible with a slightly damp cloth. The surface unit should then be dried by switching on for a few minutes. After it cools, wipe lightly with cooking oil.

Clean very dirty solid disk surface units with a little cleaning powder (such as Comet® cleanser) or with a scouring pad .

The matte black surface can be maintained by treating it periodically with the Collo Electrol® polish which is available from your GE supplier.

Use the applicator to apply a very thin coating of the polish to the entire unit surface. Turn the surface unit on high for several minutes to bake the polish to the unit. When the unit is cooled, rub lightly with a cloth or paper towel to remove any excess polish. Before next use, burn off the surface unit by means of a short preheating period. A slight amount of smoke and odor will occur.

Do not use covers over the solid disk surface units. A surface unit turned on while the cover is in place can permanently damage the cooktop. Covers can also trap moisture which may cause the units to rust.

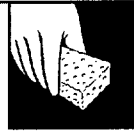

Surface Light and Starter (on some models)

Do not touch the bulb when it is hot or with wet hands. Never wipe the light area with a wet cloth. Electrical power must be shut off if you have to replace a broken bulb.

To replace the bulb:

1. Flip the front of the hinged canopy up.
2. Remove the fluorescent light bulb. Replace the bulb with one of the same length and wattage.
3. Lower the canopy.

To replace the starter:

1. Open the canopy and remove the bulb as explained above.
2. Grasp the starter, turn it counterclockwise, about one quarter turn and lift out. Replace with one of the same wattage.
3. Reposition the bulb and lower the canopy.

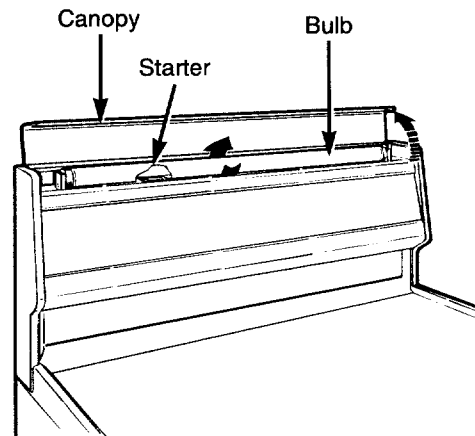

Control Panel and Knobs

It's a good idea to wipe the control panel after each use of the oven. Clean with mild soap and water or vinegar and water, rinse with clean water and polish dry with a soft cloth.

Do not use abrasive cleansers, strong liquid cleansers, plastic scouring pads or oven cleansers on the control panel—they will damage the finish. A 50/50 solution of vinegar and hot water solution works well.

The control knobs may be removed for easier cleaning.

Before removing the knobs for cleaning, please note that the knobs on the left side and the knobs on the right side are in the proper OFF position. When replacing the knobs, check the OFF position to insure proper placement.

To remove the knob, pull it straight off the spring clip. If it is difficult to remove, place a thin cloth (like a handkerchief) or a piece of string under and around the knob edge and pull up.

The knob stem has a groove in each side. The groove on one side has a spring clip. The other groove is clear (see illustration). Check the inside of the knob and find the molded rib. Replace the knob by fitting the molded rib inside the knob into the clear groove on the stem. Wash the knobs in soap and water or a

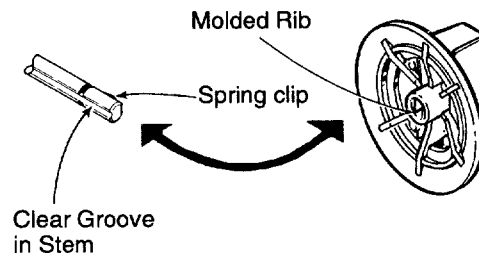

Glass Surfaces

To clean the outside glass finish, use a glass cleaner. Rinse and polish with a dry cloth. Do not allow the water or cleaner to run down inside openings in the top of the oven door while cleaning.

Painted Surfaces

Painted surfaces include the outside oven door, sides, control panel and drawer front. Clean these with soap and water or a vinegar and water solution.

Do not use commercial oven cleaners, cleansing powders, steel wool or harsh abrasives on any painted surface.

Metal Parts

Do not use steel wool, abrasives, ammonia or commercial oven cleaners. To safely clean surfaces; wash, rinse and then dry with a soft cloth.

(continued next page)



CARE AND CLEANING

(continued)

Oven Light Bulb

The light bulb is located on the back wall of the oven. Before replacing the bulb, **disconnect electrical power to the range** at the main fuse or circuit breaker panel or unplug the range from the electrical outlet. Let the bulb cool completely before removing it. For your safety, do not touch a hot bulb with a damp cloth. If you do, the bulb will break.

To remove: Unscrew the cover and remove the bulb.

To replace: Put in a new 40-watt appliance bulb.

NOTE: A 40-watt appliance bulb is smaller than a standard 40-watt household bulb.

- Install and tighten the cover.
- Reconnect electrical power to the range.

DO NOT REMOVE SCREWS.

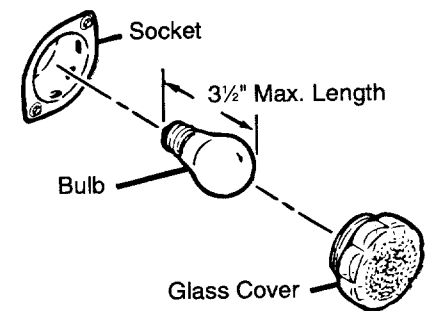

Broiler Pan and Rack

After broiling, remove the broiler pan from the oven. Remove the rack from the pan, carefully pour out the grease in the pan into a proper container. Wash and rinse the pan and rack in hot soapy water.

If food has burned on, sprinkle the rack while hot with detergent and cover with wet paper towels or a dishcloth. Burned-on foods will soak loose while the meal is being served.

The broiler pan and rack may also be cleaned in a dishwasher.

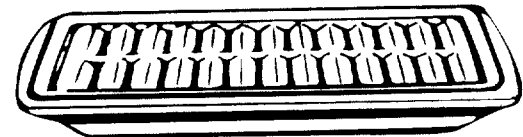

Do not store a soiled broiler pan and rack in the oven. Do not clean in the self-cleaning oven.

Removable Storage Drawer

The storage drawer is a good place to store cookware and bakeware. Do not store plastics and flammable material in the drawer.

Do not overload the storage drawer. If the drawer is too heavy, it may slip off the track when opened. To open the drawer, grasp the center of the handle and pull straight out.

The storage drawer may be removed for cleaning under the range.

To remove: Pull the drawer straight out and lift over the guide stops.

To replace: Lift over the guide stops and slide the drawer into place.

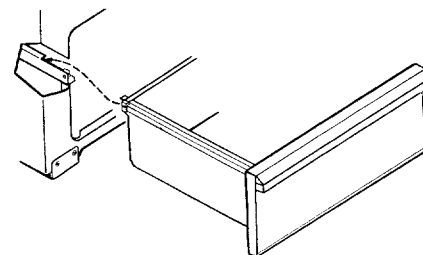

To clean both the inside and the outside: Wipe with soap and water. Rinse well.

Do not use cleansing powders or harsh abrasives which may scratch the surface.

Oven Vent

The oven vent is located at the rear of the cooktop. Do not obstruct this opening. Keep the vent clean.

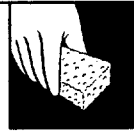

Removable Oven Door

The oven door is removable, but it is heavy. You may need help removing and replacing the door.

Do not lift the door by the handle. This could cause the glass to break or cause damage to the door.

To remove the door, open it a few inches to the special stop position that will hold the door open. Grasp firmly on each side and lift the door straight up and off the hinges.

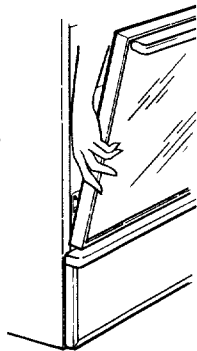

NOTE: Be careful not to place hands between the hinge and the oven door frame as the hinge could snap back and pinch fingers.

To replace the door, make sure the hinges are in the special stop position. Position the slots in the bottom of the door squarely over the hinges. Then lower the door slowly and evenly over both hinges at the same time. If hinges snap back against the oven frame, pull them back out.

TO CLEAN THE DOOR:

Inside of door:

- Because the area inside the gasket is cleaned during the self clean cycle, you do not need to clean this by hand. Any soap left on the liner causes additional stains when the oven is heated.
- The area outside the gasket can be cleaned with a scouring pad.
- Do not rub or clean the door gasket—the fiberglass material of the gasket has an extremely low resistance to abrasion. An intact and well-fitting oven door gasket is essential for energy-efficient oven operation and good baking results. If you notice the gasket becoming worn, frayed or damaged in any way or if it has become displaced on the door, you should have it replaced.

NOTE: The gasket is designed with a gap at the bottom to allow for proper air circulation.

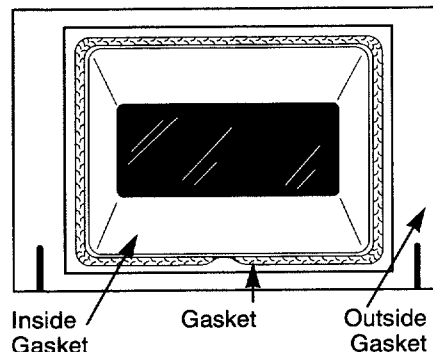

Outside of door:

- Use soap and water to thoroughly clean the top, sides and front of the oven door. Do not let water run down through openings in the top of the door. Rinse well. You may also use a glass cleaner to clean the glass on the outside of the door.
- Spillage of marinades, fruit juices, tomato sauces and basting materials containing acids may cause discoloration and should be wiped up immediately. When surface is cool, clean and rinse.
- **Do not use oven cleaners, cleansing powders or harsh abrasives on the outside of the door.**

NOTE: Do not clean the bake unit or the broil unit. Any soil will burn off when the units are heated. The bake unit can be lifted gently to clean the oven floor. If spillover, residue, or ash accumulate around the bake unit, gently wipe around the unit with warm water.

Oven Shelves

Clean the shelves with a mild abrasive cleanser. After cleaning, rinse the shelves with clean water and dry with a clean cloth.

The oven shelves may be cleaned in the self-cleaning oven. However, they will darken, lose their luster and become hard to slide. Wipe the shelf supports with cooking oil after self-cleaning to make shelves slide more easily.

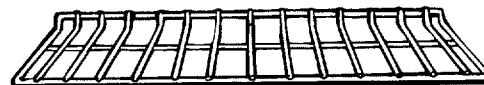

To remove heavy, burned on soil, soapy metal pads may be used. After scrubbing, wash with soapy water, rinse and dry.

(continued next page)



CARE AND CLEANING

(continued)



WARNING

- All ranges can tip.
- Injury could result.
- Install the Anti-tip device packed with the range.
- See the Installation Instructions.

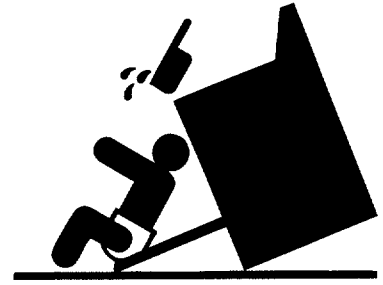

STABILITY DEVICE INSTALLATION INSTRUCTIONS FOR BRACKET KIT NO. 342473

Tools needed:

- Phillips head screwdriver
- 1 $\frac{3}{8}$ " open end or adjustable wrench

The bracket attaches to floor or wall to hold either the right or left rear leg leveler. If fastening to the floor, be sure that the screws do not penetrate electrical wiring or plumbing. If this cannot be determined, use shorter screws that will not penetrate through flooring.

If the bracket came with your range, it is shipped attached to the lower range back. Remove and discard the shipping screw that holds the bracket and then follow the instructions below.

1. Decide whether the bracket will be installed on the right or left side of the range location.
2. If the bracket side of the range is adjacent to a cabinet, place the bracket against back wall and cabinet as shown in Figure 1.

If there is no adjacent cabinet, determine where the location of the range side (painted outside panel) will be. Place the bracket with its outside edge at this location and against the back wall. See Figure 1.

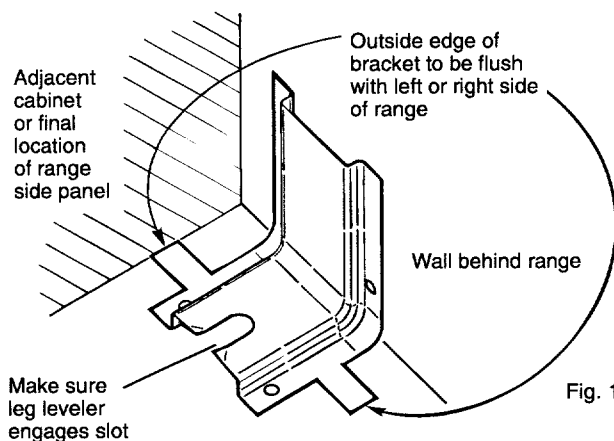

3. Determine whether you will anchor the bracket to the floor or wall. Fasten the bracket securely with the screws provided. The screws are self-drilling in wood, plywood, particle and chip board, and most metal framing. If attaching to masonry you can buy suitable screws and anchors at hardware stores. Use a masonry drill to drill the required holes.
4. Using the wrench, back out the four leg levelers at least two turns. See the Installation Instructions for more leveling information before positioning range.
5. Slide the range into place. Be sure the rear leg leveler fully engages the slot in the bracket. If the range cannot be moved back far enough for the rear leg leveler to enter the bracket, move the bracket forward as required and attach to the floor in the new location.

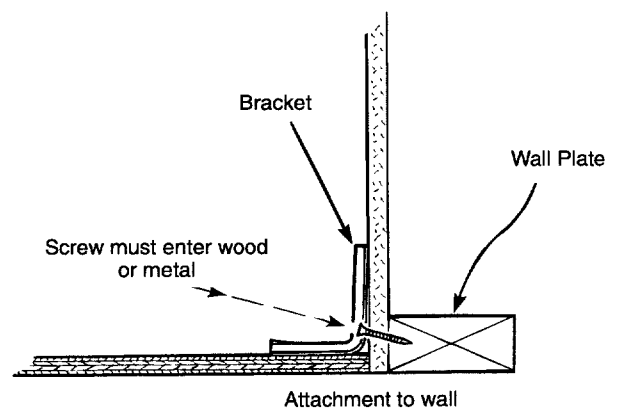

QUESTIONS? USE THIS PROBLEM SOLVER



PROBLEM	POSSIBLE CAUSE
"BURNING" OR "OILY" ODOR EMITTING FROM OVEN WHEN TURNED ON	<ul style="list-style-type: none"> This is normal in a new oven and will dissipate in time. To speed the process, set a self-clean cycle (see the Operating the Self-Cleaning Oven section) lasting at least 3 hours.
OVEN LIGHT DOES NOT WORK	<ul style="list-style-type: none"> Light bulb is loose or defective. Tighten or replace. Switch operating oven light is broken. Call for service.
OVEN WILL NOT WORK	<ul style="list-style-type: none"> The plug on the range is not completely inserted in the electrical outlet. The circuit breaker in your house has been tripped, or a fuse has been blown. The oven controls are not properly set.
FOOD DOES NOT BROIL PROPERLY	<ul style="list-style-type: none"> Oven not set on Broil. Oven temperature not set correctly. Improper shelf position being used. See the Broiling Guide. Food is being cooked on hot pan. Cookware is not suited for broiling. Aluminum foil used on the broil pan rack has not been fitted properly and slit as recommended.
FOOD DOES NOT ROAST OR BAKE PROPERLY	<ul style="list-style-type: none"> Oven not set on Bake. Oven temperature is not set correctly. Shelf position is incorrect. See the Roasting or Baking sections. The oven shelf is not level. Incorrect cookware or cookware of improper size is being used. A foil tent was not used when needed to slow down browning during roasting.
OVEN WILL NOT SELF-CLEAN	<ul style="list-style-type: none"> The Stop Time must be more than 3½ hours later than the Start Time. The oven temperature is too high to set the self-clean operation. Allow the range to cool and reset the controls. The door latch handle not moved all the way to the right.
OVEN DOOR WON'T OPEN AFTER SELF-CLEAN CYCLE	<ul style="list-style-type: none"> The oven must cool below locking temperature.
OVEN NOT CLEAN AFTER CLEAN CYCLE	<ul style="list-style-type: none"> The oven controls are not set properly. Heavy spillovers should be cleaned up before starting clean cycle.
OVEN DOOR ACCIDENTALLY LOCKED DURING COOKING	<ul style="list-style-type: none"> Push the CANCEL button. Allow the oven to cool. Never force the door lock handle.
SURFACE LAMP DOES NOT WORK (on some models)	<ul style="list-style-type: none"> The fluorescent lamp is loose or defective. Adjust or replace. Press switch for 2 seconds. If lamp does not come on, repeat. The switch operating the oven light is broken. Call for service.
OVEN TEMPERATURE TOO HOT OR TOO COLD	<ul style="list-style-type: none"> The oven thermostat needs adjustment. See the <i>Do It Yourself</i>—Adjust the Oven Thermostat section.

(continued next page)



THE PROBLEM SOLVER

(continued)

PROBLEM	POSSIBLE CAUSE
SURFACE UNITS WILL NOT MAINTAIN A ROLLING BOIL OR FRYING RATE IS NOT FAST ENOUGH	<ul style="list-style-type: none">• You must use pans which are absolutely flat. If light can be seen between the pan bottom and a straight edge, the units will not transfer heat properly.• Pan bottoms should closely match the diameter of the surface unit selected.
COOKTOP FEELS HOT	<ul style="list-style-type: none">• Because the units heat by conduction, the cooktop surfaces may seem hotter than you are used to. This is normal. Make sure flat-bottom pans are used.
FOODS COOK SLOWLY	<ul style="list-style-type: none">• Improper cookware being used. Pan bottoms should be flat, fairly heavy weight and the same diameter as the surface unit selected.
SURFACE UNITS DO NOT WORK PROPERLY	<ul style="list-style-type: none">• Difficulty may be in the main distribution panel of your house, caused by a blown oven-circuit fuse, a tripped oven-circuit breaker, the main fuse or the main circuit breaker, depending on the nature of the power supply. If a circuit breaker is involved, reset it. If the control box uses fuses, the oven fuse (a cartridge-type) should be changed, BUT ONLY BY SOMEONE FAMILIAR WITH ELECTRICAL CIRCUITS. If after performing 1 of these procedures, the fuse blows or circuit breaker trips again, call for service. NOTE: Apartment tenants or condominium owners should ask their building management to perform this check before calling for service.• Cooktop surface unit controls are not properly set, or the wrong control knob is set for the surface unit you are using.
SOLID DISK SURFACE UNITS NOT FUNCTIONING PROPERLY	<ul style="list-style-type: none">• Solid disk surface unit controls are not properly set.• Use proper flat-bottom cookware that is warped, rounded or curved. Improper cookware will cause unsatisfactory cooking results.
SOLID DISK SURFACE UNITS SMOKE WHILE HEATING	<ul style="list-style-type: none">• Some smoke and odor is normal when using solid disk surface units for the first time and also after using Collo Electrol® cleaner.

If you need more help...call, toll free:
GE Answer Center®
800.626.2000
consumer information service

We'll Be There

With the purchase of your new GE appliance, receive the assurance that if you ever need information or assistance from GE, we'll be there. All you have to do is call—toll-free!

In-Home Repair Service

800-GE-CARES (800-432-2737)

A GE consumer service professional will provide expert repair service, scheduled at a time that's convenient for you. Many GE Consumer Service company-operated locations offer you service today or tomorrow, or at your convenience (7:00 a.m. to 7:00 p.m. weekdays, 9:00 a.m. to 2:00 p.m. Saturdays). Our factory-trained technicians know your appliance inside and out—so most repairs can be handled in just 1 visit.

GE Answer Center®

800.626.2000

Whatever your question about any GE major appliance, GE Answer Center® information service is available to help. Your call—and your question—will be answered promptly and courteously. And you can call any time. GE Answer Center® service is open 24 hours a day, 7 days a week.

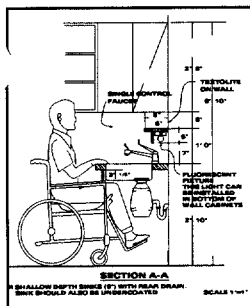

For Customers With Special Needs...

Upon request, GE will provide Braille controls for a variety of GE appliances, and a brochure to assist in planning a barrier-free kitchen for persons with limited mobility. To obtain these items, free of charge, call 800.626.2000.

Consumers with impaired hearing or speech who have access to a TDD or a conventional teletypewriter may call 800-TDD-GEAC (800-833-4322) to request information or service.

Service Contracts

800-626-2224

You can have the secure feeling that GE Consumer Service will still be there after your warranty expires. Purchase a GE contract while your warranty is still in effect and you'll receive a substantial discount. With a multiple-year contract, you're assured of future service at today's prices.

Parts and Accessories

800-626-2002

Individuals qualified to service their own appliances can have needed parts or accessories sent directly to their home. The GE parts system provides access to over 47,000 parts...and all GE Genuine Renewal Parts are fully warranted. VISA, MasterCard and Discover cards are accepted.

User maintenance instructions contained in this booklet cover procedures intended to be performed by any user. Other servicing generally should be referred to qualified service personnel. Caution must be exercised, since improper servicing may cause unsafe operation.

YOUR GE SOLID DISK RANGE WARRANTY

Staple sales slip or cancelled check here. Proof of original purchase date is needed to obtain service under warranty.

WHAT IS COVERED

FULL ONE-YEAR WARRANTY

For one year from date of original purchase, we will provide, free of charge, parts and service labor in your home to repair or replace **any part of the cooktop** that fails because of a manufacturing defect.

LIMITED ADDITIONAL FOUR-YEAR WARRANTY

For the second through fifth year from date of original purchase, we will provide, free of charge, a replacement solid element surface heating unit if the element fails because of a manufacturing defect. You pay for the service trip to your home and service labor charges. This warranty does not cover Automatic Surface Unit components, wiring, or switches.

This warranty is extended to the original purchaser and any succeeding owner for products purchased for ordinary home use in the 48 mainland states, Hawaii and Washington, D.C. In Alaska the warranty is the same except that it is LIMITED because you must pay to ship the product to the service shop or for the service technician's travel costs to your home.

All warranty service will be provided by our Factory Service Centers or by our authorized Customer Care® servicers during normal working hours.

Should your appliance need service, during warranty period or beyond, call 800-GE-CARES (800-432-2737).

WHAT IS NOT COVERED

- Service trips to your home to teach you how to use the product.

Read your Use and Care material.

If you then have any questions about operating the product, please contact your dealer or our Consumer Affairs office at the address below, or call, toll free:

GE Answer Center®
800.626.2000
consumer information service

- Improper installation.

If you have an installation problem, contact your dealer or installer. You are responsible for providing adequate electrical, gas, exhausting and other connecting facilities as

described in the Installation Instructions provided with the product.

- Replacement of house fuses or resetting of circuit breakers.
- Failure of the product if it is used for other than its intended purpose or used commercially.
- Damage to product caused by accident, fire, floods or acts of God.

WARRANTOR IS NOT RESPONSIBLE FOR CONSEQUENTIAL DAMAGES.

Some states do not allow the exclusion or limitation of incidental or consequential damages, so the above limitation or exclusion may not apply to you. This warranty gives you specific legal rights, and you may also have other rights which vary from state to state. To know what your legal rights are in your state, consult your local or state consumer affairs office or your state's Attorney General.

Warrantor: General Electric Company

**If further help is needed concerning this warranty, write:
Manager—Consumer Affairs, GE Appliances, Louisville, KY 40225**

Part No. 164D2588P238

Pub No. 49-8439

MNU106 Rev. 2

3-93 CG

JBP29G
JB57 M
JB57 M

Printed in the United States

Free Manuals Download Website

<http://myh66.com>

<http://usermanuals.us>

<http://www.somanuals.com>

<http://www.4manuals.cc>

<http://www.manual-lib.com>

<http://www.404manual.com>

<http://www.luxmanual.com>

<http://aubethermostatmanual.com>

Golf course search by state

<http://golfingnear.com>

Email search by domain

<http://emailbydomain.com>

Auto manuals search

<http://auto.somanuals.com>

TV manuals search

<http://tv.somanuals.com>