



# Refrigerators

*Safety Information* . . . . .2-4

*Operating Instructions*

Care and Cleaning . . . . .7-9

Control Settings . . . . .5

Refrigerator Features . . . . .6

Replacing the Light Bulb . . . . .7

*Installation Instructions* . .10-12

*Troubleshooting Tips* . . .13, 14

*Consumer Support*

Consumer Support . .Back Cover

Warranty . . . . .15

**Owner's Manual  
& Installation  
Instructions**

2 Cubic Foot Models

3 Cubic Foot Models

4 Cubic Foot Models

6 Cubic Foot Models

## **ATTENTION:**

**Defrosting—Do not use sharp, pointed objects to remove frost or ice from surfaces of the refrigerator and/or freezer compartment. Doing so could puncture the cooling coil, causing the unit to lose its ability to maintain cold temperatures and voiding the warranty. See the *Care and Cleaning* section for instructions on defrosting the refrigerator and/or freezer compartment.**

**Write the model and serial numbers here:**

**Model #** \_\_\_\_\_

**Serial #** \_\_\_\_\_

Find these numbers on a label inside the refrigerator on the side wall.



# IMPORTANT SAFETY INFORMATION. READ ALL INSTRUCTIONS BEFORE USING.

## ⚠ WARNING!

Use this appliance only for its intended purpose as described in this Owner's Manual.

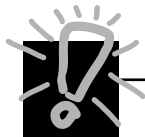

## SAFETY PRECAUTIONS

When using electrical appliances, basic safety precautions should be followed, including the following:

- This refrigerator must be properly installed and located in accordance with the Installation Instructions before it is used.
- Do not allow children to climb, stand or hang on the shelves in the refrigerator. They could damage the refrigerator and seriously injure themselves.
- Do not store or use gasoline or other flammable vapors and liquids in the vicinity of this or any other appliance.
- **Before replacing a burned-out light bulb, the refrigerator should be unplugged** in order to avoid contact with a live wire filament. (A burned-out light bulb may break when being replaced.)
- Keep fingers out of the “pinch point” areas; clearances between the doors and cabinet are necessarily small. Be careful closing doors when children are in the area.
- Unplug the refrigerator before cleaning and making repairs.
- GE does not support any servicing of the refrigerator.
- Turning the temperature control dial to the **OFF** position stops cooling but does not shut off power to the refrigerator.

## ⚠ DANGER! RISK OF CHILD ENTRAPMENT PROPER DISPOSAL OF THE REFRIGERATOR

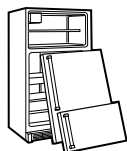

Child entrapment and suffocation are not problems of the past. Junked or abandoned refrigerators are still dangerous... even if they will sit for “just a few days.” If you are getting rid of your old refrigerator, please follow the instructions below to help prevent accidents.

### **Before You Throw Away Your Old Refrigerator or Freezer:**

- Take off the doors.

- Leave the shelves in place so that children may not easily climb inside.

### **Refrigerants**

All refrigeration products contain refrigerants, which under federal law must be removed prior to product disposal. If you are getting rid of an old refrigeration product, check with the company handling the disposal about what to do.



## USE OF EXTENSION CORDS

*Because of potential safety hazards under certain conditions, we strongly recommend against the use of an extension cord.*

However, if you must use an extension cord, it is absolutely necessary that it be a UL-listed, 3-wire grounding type appliance extension cord having a grounding type plug and outlet and that the electrical rating of the cord be 15 amperes (minimum) and 120 volts.



## HOW TO CONNECT ELECTRICITY

*Do not, under any circumstances, cut or remove the third (ground) prong from the power cord. For personal safety, this appliance must be properly grounded.*

The power cord of this appliance is equipped with a 3-prong (grounding) plug which mates with a standard 3-prong (grounding) wall outlet to minimize the possibility of electric shock hazard from this appliance.

Have the wall outlet and circuit checked by a qualified electrician to make sure the outlet is properly grounded.

If you have only a standard 2-prong wall outlet, it is your personal responsibility and obligation to have it replaced with a properly grounded 3-prong wall outlet.

The refrigerator should always be plugged into its own individual electrical outlet which has a voltage rating that matches the rating plate.

This provides the best performance and also prevents overloading house wiring circuits which could cause a fire hazard from overheated wires.

Never unplug your refrigerator by pulling on the power cord. Always grip plug firmly and pull straight out from the outlet.

Repair or replace immediately all power cords that have become frayed or otherwise damaged. Do not use a cord that shows cracks or abrasion damage along its length or at either end.

When moving the refrigerator away from the wall, be careful not to roll over or damage the power cord.

# IMPORTANT SAFETY INFORMATION. READ ALL INSTRUCTIONS BEFORE USING.

---

## **⚠ WARNING!**



### USE OF ADAPTER PLUGS

---

*Because of potential safety hazards under certain conditions, we strongly recommend against the use of an adapter plug.*

However, if you must use an adapter, where local codes permit, a **temporary connection** may be made to a properly grounded 2-prong wall outlet by use of a UL-listed adapter available at most local hardware stores.

The larger slot in the adapter must be aligned with the larger slot in the wall outlet to provide proper polarity in the connection of the power cord.

When disconnecting the power cord from the adapter, always hold the adapter in place with one hand while pulling the power cord plug with the other hand. If this is not done, the adapter ground terminal is very likely to break with repeated use.

If the adapter ground terminal breaks, **DO NOT USE** the refrigerator until a proper ground has been established.

*Attaching the adapter ground terminal to a wall outlet cover screw does not ground the appliance unless the cover screw is metal, and not insulated, and the wall outlet is grounded through the house wiring. You should have the circuit checked by a qualified electrician to make sure the outlet is properly grounded.*



*READ AND FOLLOW THIS SAFETY  
INFORMATION CAREFULLY.*

---

## **SAVE THESE INSTRUCTIONS**

# About the control on the refrigerator.

www.GEAppliances.com

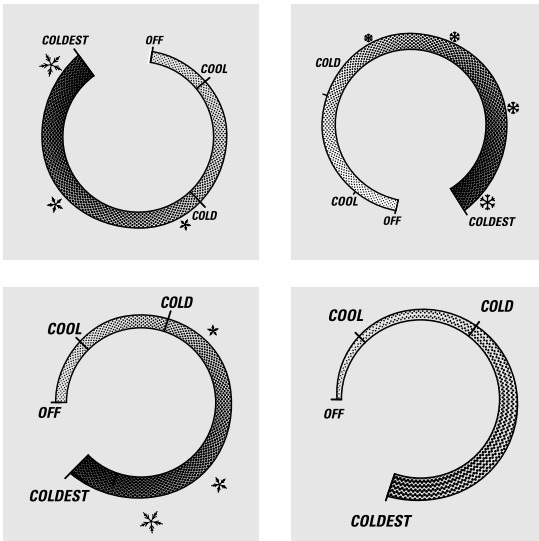

The control will look like one of the above.



## Control Settings

The temperature control maintains the temperature in the refrigerator. Setting the control at **COOL** is the warmest setting. Setting the control at **COLDEST** is the coldest setting. Set the control at **COLD**.

Allow 24 hours for the refrigerator to reach the **COLD** temperature. If you want a colder or warmer temperature, move the dial one setting at a time. Moving the control to **OFF** stops cooling but does not turn off the power to the refrigerator. Setting the control to one of the snowflake positions may cause freezing in the refrigerator depending on the room temperature.

### How To Test Temperatures

Use the milk test. Place a container of milk on a shelf and check it a day later. If the milk is too warm or too cold, adjust the temperature control.

*After changing the control, allow 24 hours for the refrigerator to reach the temperature you have set.*

## About the refrigerator features.

### Shelves

To remove a shelf, lift up the back slightly and pull forward. Some models have multi-position shelves that can be moved to different levels.

### Ice Tray Compartment (on some models)

This compartment is designed for production of ice cubes and short-term storage (a few days at most) of some commercially-frozen foods when in contact with the evaporator (cold surface in compartment.)

### Door Shelves

Shelves on the door provide convenient storage for frequently used items. Some models have doors that are deep enough to store large bottles.

### Key-Ejecting Lock (on some models)

The key for the spring-loaded lock is automatically ejected—key will not remain in lock in either the open or closed position.

*Keep the key out of reach of children and away from the refrigerator.*

If a replacement key is needed, it can be ordered by visiting our Website [www.GEAppliances.com](http://www.GEAppliances.com), or calling GE Parts and Accessories, 800.626.2002.

### Refrigerator Storage Zones (on cycle defrost all-refrigerator models)

For best results follow the recommended storage zones:

- The top and (front) middle shelf are best for storing fruits and vegetables.
- The (rear) middle shelf and bottom shelf are best for storing beverages, deli meats and cheeses.

#### REFRIGERATOR STORAGE ZONES BEST FOR FRUITS, VEGETABLES

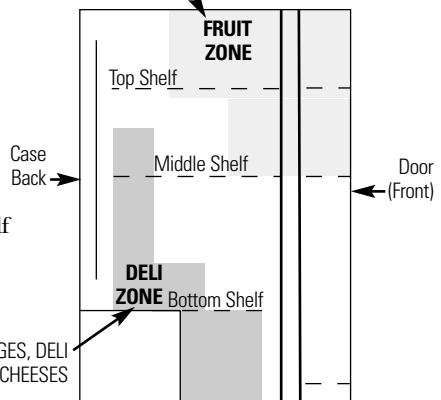

Side View of Refrigerator

# Care and cleaning of the refrigerator.

www.GEAppliances.com

Safety Instructions

Operating Instructions

Installation Instructions

Troubleshooting Tips

Consumer Support

## Cleaning the Outside

**Keep the outside clean.** Wipe with a clean cloth lightly dampened with kitchen appliance wax or mild liquid dish detergent. Dry and polish with a clean, soft cloth.

*Do not wipe the refrigerator with a soiled dish cloth or wet towel. These may leave a residue that can erode the paint. Do not use scouring pads, powdered cleaners, bleach or cleaners containing bleach because these products can scratch and weaken the paint finish.*

**Protect the paint finish.** The finish on the outside of the refrigerator is a high quality, baked-on paint finish. With proper care, it will stay new-looking and rust-free for years. Apply a coat of kitchen/appliance wax when the refrigerator is new, and then at least twice a year.

## Cleaning the Inside

**To help prevent odors,** leave an open box of baking soda in the refrigerator.

**Unplug the refrigerator before cleaning.** If this is not practical, wring excess moisture out of sponge or cloth when cleaning around the control.

Use warm water and baking soda solution—about a tablespoon (15 ml) of baking soda to a quart (1 liter) of water. This both cleans and neutralizes odors. Rinse and wipe dry.

Other parts of the refrigerator—including door gaskets, fruit and vegetable drawers, and all plastic parts—can be cleaned the same way.

*Do not wash any plastic refrigerator parts in the dishwasher.*

## Replacing the Light Bulb (on some models)

Unplug the refrigerator before replacing a burned-out bulb. Setting the controls to **OFF** does not remove power to the light circuit.

The light bulb is located behind the temperature control housing and is visible through the slots in the housing.

Reach up through the opening at the bottom of the control housing and gently unscrew the light bulb. Replace with a bulb of the same or lower wattage.

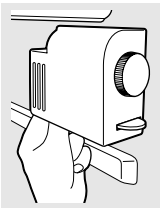
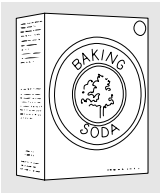

## Care and cleaning of the refrigerator.

---

### **Defrosting** (on manual defrost models with freezer area)

Defrost whenever frost on the wall of the ice tray compartment becomes 1/4" thick. **Never use a sharp or metallic instrument to remove frost as it may damage the cooling coils.** (A punctured cooling coil will cause serious problems and void the warranty.) We recommend using a plastic scraper. Do not use any electrical device in defrosting your refrigerator.

#### **To defrost:**

- Remove foods and ice trays from the ice tray compartment.
- Set the temperature control dial at **OFF** position.
- On models without a drip tray, place a pan beneath the ice tray compartment to collect water.

Defrosting usually takes a few hours. To defrost faster, keep the door open. Also, pouring warm (not hot) water on the frosted part may speed defrosting. **Do not use boiling water**—it may damage plastic parts.

#### **After defrosting:**

- Empty water from the drip tray or from the pan placed beneath the ice tray compartment. Wash the tray or pan with warm water.
- Wipe the ice tray compartment with a damp cloth.
- Turn the temperature control to the desired setting and return food and ice trays to the refrigerator.

**NOTE:** If ice buildup is very thick, it may keep the ice tray compartment door from opening or closing completely. Don't try to force it open; after defrosting, the door will open and close easily.

---

### **Defrosting** (on cycle defrost all-refrigerator models)

Defrost whenever frost on the inside surfaces of the storage area becomes 1/8" (3 mm) thick. **Never use a heater of any kind, scraper or sharp metallic instrument to remove frost as it may damage the refrigerator or cooling coils.** (A punctured cooling coil will cause serious problems and void the warranty.)

**To defrost,** unplug the refrigerator or turn the temperature control dial to the **OFF** position. Remove the contents and wipe inside surfaces and shelves with a clean towel. If frost does not come off easily, allow the frost to melt somewhat and wipe off.

**After defrosting,** make sure inside surfaces are dry; then return the contents to the refrigerator; plug unit back in and set the temperature control to the desired setting.



# Care and cleaning of the refrigerator.

[www.GEAppliances.com](http://www.GEAppliances.com)

---

## ***Preparing for Vacation***

For long vacations or absences, remove food and unplug the refrigerator. Move the control to the **OFF** position, and clean the interior with a baking soda solution of one tablespoon (15 ml) of baking soda to one quart (1 liter) of water. Leave the door open.

---

## ***Preparing to Move***

Secure all loose items such as shelves and ice trays by taping them securely in place to prevent damage.

*Be sure the refrigerator stays in an upright position during moving.*

Safety Instructions

Operating Instructions

Installation Instructions

Troubleshooting Tips

Consumer Support

## Preparing to install the refrigerator.

**Read these instructions completely and carefully.**



### Refrigerator Location

- Do not install the refrigerator where the temperature will go below 50°F (10°C) because it will not run often enough to maintain proper temperatures.
- Install it on a floor strong enough to support it fully loaded.
- If the 2 cubic foot model is placed on a countertop or stand, the front surface of the door should be 3" or more back from the edge of the countertop or stand to avoid accidental tipping of the appliance during normal use.
- Do not install it closer than 5" (13 cm) next to a range.

**The following applies only to the 2, 3 and 4 Cubic Foot Models:**

- Do not install it in a recessed area.
- Do not build in the refrigerator.

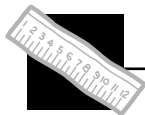

### Clearances

Allow the following clearances for ease of installation and proper air circulation.

	<b>2, 3 and 4 Cubic Foot Models</b>	<b>6 Cubic Foot Model only</b>
<b>Sides</b>	1/2" (13 mm)	0" (0 mm)*
<b>Top</b>	2" (51 mm)	0" (0 mm)
<b>Back</b>	2" (51 mm)**	0" (0 mm)

\*1-1/4" (32 mm) for hinge side clearance

\*\*From the rear cabinet surface to the wall

### Leveling Legs (on some models)

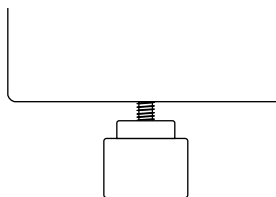

Turn counterclockwise to raise, clockwise to lower.

**Adjustable legs** at the front corners of the refrigerator should be set so the refrigerator is firmly positioned on the floor and the front is raised just enough that the door closes easily when opened about halfway.

**To adjust the leveling legs**, turn the legs **counterclockwise to raise** the refrigerator, **clockwise to lower** it.

# Preparing to install the refrigerator.

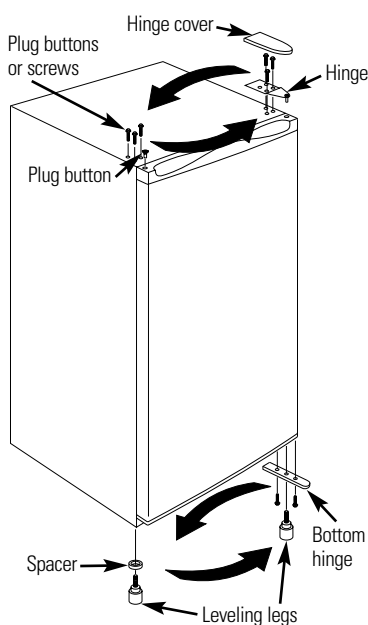

## Door Reversal (on some models)

1. Remove the small plug button on the left side of the door top cap.
2. Remove the three plug buttons or screws on the left side on top of the cabinet.
3. Remove the plastic hinge cover by lifting it up by the front edge.
4. Remove the three screws from the top hinge.
5. Lift the door up and off the bottom hinge (right side).
6. Tilt the refrigerator cabinet back to remove the right leveling leg.
7. Remove the screws on the bottom hinge (right side) and the left leveling leg. Move the bottom hinge to the left side and secure it with the screws and leveling leg.  
**IMPORTANT:** The left leg has a spacer that must be moved to the right side leveling leg when the door swing is reversed.
8. Screw the right leveling leg, with the spacer in place, back in place on the right side.
9. Position the door on the left bottom hinge. With the magnetic gasket holding the door in place, secure the top hinge with screws.
10. **Make sure the door is aligned with the refrigerator cabinet before continuing.**
11. Replace the hinge cover on top of the hinge.
12. Put the plug button in the hole on the right side of the door cap.
13. Put the three plug buttons on the right side on top of the cabinet.

## Preparing to install the refrigerator.

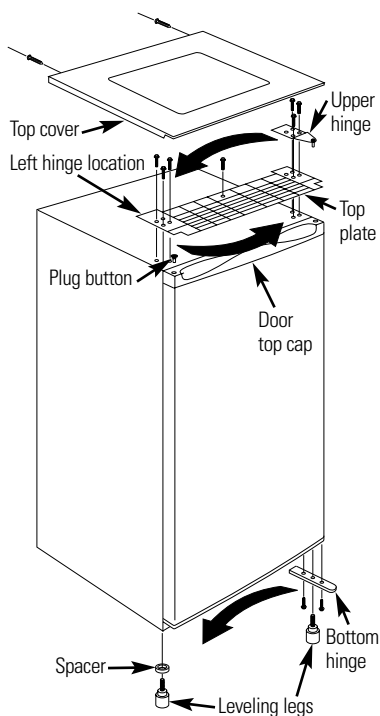

### Door Reversal (on some models)

#### 4 Cubic Foot Models

1. Remove the two screws at the back of the top cover.
  2. Remove the top cover by lifting the back up about 2" and then sliding it forward.
  3. Remove the small plug button on the left side of the door top cap.
  4. Remove the three screws on the upper hinge (right side). Remove the hinge.
  5. Remove the three screws at the left hinge location on the top plate.
  6. Remove the screw in the middle of the top plate and remove the top plate.
  7. Lift the door up and off the bottom hinge (right side).
  8. Tilt the refrigerator cabinet back to remove the right leveling leg.
  9. Remove the screws on the bottom hinge (right side) and the left leveling leg. Move the bottom hinge to the left side and secure it with the screws and leveling leg.
- IMPORTANT:** The left leg has a spacer that must be moved to the right side leveling leg when the door swing is reversed.
10. Screw the right leveling leg, with the spacer in place, back in place on the right side.
  11. Position the door on the left bottom hinge. With the magnetic gasket holding the door in place, secure the top hinge with screws.
  12. **Make sure the door is aligned with the refrigerator cabinet before continuing.**
  13. Replace the top plate and screws.
  14. Slide the top cover back in place and replace the two screws.
  15. Put the plug button in the hole on the right side of the door top cap.



Save time and money!

<b>Problem</b>	<b>Possible Causes</b>	<b>What To Do</b>
<b>Refrigerator does not operate</b>	Control in <b>OFF</b> position.	<ul style="list-style-type: none"> <li>• Move the control to a temperature setting.</li> </ul>
	Refrigerator is unplugged.	<ul style="list-style-type: none"> <li>• Push the plug completely into the outlet.</li> </ul>
	The fuse is blown/circuit breaker is tripped.	<ul style="list-style-type: none"> <li>• Replace fuse or reset the breaker.</li> </ul>
<b>Vibration or rattling (slight vibration is normal)</b>	Front leveling legs (on some models) need adjusting.	<ul style="list-style-type: none"> <li>• See <i>Leveling Legs</i>.</li> </ul>
	Refrigerator is on an uneven surface.	<ul style="list-style-type: none"> <li>• Use shims to level the refrigerator.</li> </ul>
<b>Motor operates for long periods or cycles</b>	Normal when refrigerator is first plugged in.	<ul style="list-style-type: none"> <li>• Wait 24 hours for the refrigerator to completely cool down.</li> </ul>
	Often occurs when large amounts of food are placed in refrigerator.	<ul style="list-style-type: none"> <li>• This is normal.</li> </ul>
	Door left open.	<ul style="list-style-type: none"> <li>• Check to see if package is holding door open.</li> </ul>
	Hot weather or frequent door openings.	<ul style="list-style-type: none"> <li>• This is normal.</li> </ul>
	Temperature control set at the coldest setting.	<ul style="list-style-type: none"> <li>• See <i>About the control</i>.</li> </ul>
	Not enough clearance from the wall.	<ul style="list-style-type: none"> <li>• See <i>Clearances in Preparing to install the refrigerator</i>.</li> </ul>
<b>Door will not open</b>	Refrigerator is locked (lock is available on some models).	<ul style="list-style-type: none"> <li>• Unlock the door with the key. If the key has been lost, a replacement key can be ordered by visiting our Website <b>www.GEAppliances.com</b>, or calling GE Parts and Accessories, 800.626.2002.</li> </ul>

## Troubleshooting tips.



Save time and money!

<b>Problem</b>	<b>Possible Causes</b>	<b>What To Do</b>
<b>Refrigerator too warm</b>	Temperature control not set cold enough.	<ul style="list-style-type: none"> <li>• See <i>About the control</i>.</li> </ul>
	Warm weather or frequent door openings.	<ul style="list-style-type: none"> <li>• Set the temperature control one step colder. See <i>About the control</i>.</li> </ul>
	Door left open.	<ul style="list-style-type: none"> <li>• Check to see if package is holding door open.</li> </ul>
	Cabinet sides are warm (applies only to 2, 3 and 4 Cubic Foot Models).	<ul style="list-style-type: none"> <li>• This is normal for a hot wall type condenser.</li> </ul>
<b>Refrigerator has odor</b>	Foods transmitting odor to refrigerator.	<ul style="list-style-type: none"> <li>• Foods with strong odors should be tightly wrapped.</li> <li>• Keep an open box of baking soda in the refrigerator; replace every three months.</li> </ul>
	Interior needs cleaning.	<ul style="list-style-type: none"> <li>• See <i>Care and cleaning</i>.</li> </ul>
	Defrost water pan needs cleaning (on some models).	<ul style="list-style-type: none"> <li>• See <i>Care and cleaning</i>.</li> </ul>
<b>Moisture forms on outside of refrigerator</b>	Not unusual during periods of high humidity.	<ul style="list-style-type: none"> <li>• Wipe surface dry.</li> </ul>
<b>Moisture collects inside (in humid weather, air carries moisture into refrigerator when door is opened)</b>	Too frequent or too long door openings.	
<b>Refrigerator too cold</b>	Temperature control set too cold.	<ul style="list-style-type: none"> <li>• See <i>About the control</i>.</li> </ul>

# GE Refrigerator

## One-Year Limited Warranty.



Staple your receipt here.

Proof of the original purchase date is needed to make a warranty claim.

### For The Period Of:

#### One Year

From the date of the original purchase

### What GE Will Provide:

**Replacement unit** for any product which fails due to a defect in materials or workmanship. The exchange unit is warranted for the remainder of your product's original one-year warranty period.

### In Order to Make a Warranty Claim:

- Properly pack your unit. We recommend using the original carton and packing materials.
- Return the product to the retail location where it was purchased.
- Include in the package a copy of the sales receipt or other evidence of date of original purchase. Also print your name and address and a description of the defect.

### What GE Will Not Cover:

- Customer instruction. This owner's manual provides information regarding operating instructions and user controls.
- Service trips to your home to teach you how to use the product.
- Improper installation, delivery or maintenance.
- Failure of the product if it is abused, misused, or used for other than the intended purpose or used commercially.
- Loss of food due to spoilage.
- Replacement of house fuses or resetting of circuit breakers.
- Replacement of the light bulbs.
- Damage caused after delivery.
- Damage to the product caused by accident, fire, floods or acts of God.
- Incidental or consequential damage caused by possible defects with this appliance.

*This warranty is extended to the original purchaser and any succeeding owner for products purchased for home use within the USA.*

*Some states do not allow the exclusion or limitation of incidental or consequential damages. This warranty gives you specific legal rights, and you may also have other rights which vary from state to state. To know what your legal rights are, consult your local or state consumer affairs office or your state's Attorney General.*

**Exclusion of implied warranties:** *Except where prohibited or restricted by law, there are no warranties, whether express, oral or statutory which extend beyond the description on the face hereof, including specifically the implied warranties of merchantability or fitness for a particular purpose.*

# Consumer Support.

---



## GE Appliances Website

[www.GEAppliances.com](http://www.GEAppliances.com)

Have a question or need assistance with your appliance? Try the GE Appliances Website 24 hours a day, any day of the year! For greater convenience and faster service, you can now download Owner's Manuals, order parts or order catalogs on-line. You can also "Ask Our Team of Experts™" your questions, and so much more...



## Real Life Design Studio

[www.GEAppliances.com](http://www.GEAppliances.com)

GE supports the Universal Design concept—products, services and environments that can be used by people of all ages, sizes and capabilities. We recognize the need to design for a wide range of physical and mental abilities and impairments. For details of GE's Universal Design applications, including kitchen design ideas for people with disabilities, check out our Website today. For the hearing impaired, please call 800.TDD.GEAC (800.833.4322).



## Parts and Accessories

[www.GEAppliances.com](http://www.GEAppliances.com)

Individuals qualified to service their own appliances can have parts or accessories sent directly to their homes (VISA, MasterCard and Discover cards are accepted). Order on-line today, 24 hours every day or by phone at 800.626.2002 during normal business hours.

**Instructions contained in this manual cover procedures to be performed by any user. GE does not support any servicing of the refrigerator.**

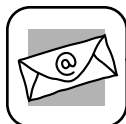

## Contact Us

[www.GEAppliances.com](http://www.GEAppliances.com)

If you are not satisfied with the service you receive on your GE product, contact us on our Website with all the details including your phone number, or write to:

General Manager, Customer Relations  
GE Appliances, Appliance Park  
Louisville, KY 40225



## Free Manuals Download Website

<http://myh66.com>

<http://usermanuals.us>

<http://www.somanuals.com>

<http://www.4manuals.cc>

<http://www.manual-lib.com>

<http://www.404manual.com>

<http://www.luxmanual.com>

<http://aubethermostatmanual.com>

Golf course search by state

<http://golfingnear.com>

Email search by domain

<http://emailbydomain.com>

Auto manuals search

<http://auto.somanuals.com>

TV manuals search

<http://tv.somanuals.com>