

How to get the best from **Yc** Refrigerator

~~TBX23~~
GG, CH, DE
DH, ZF, ZG
ZH

PUB.
49-6514

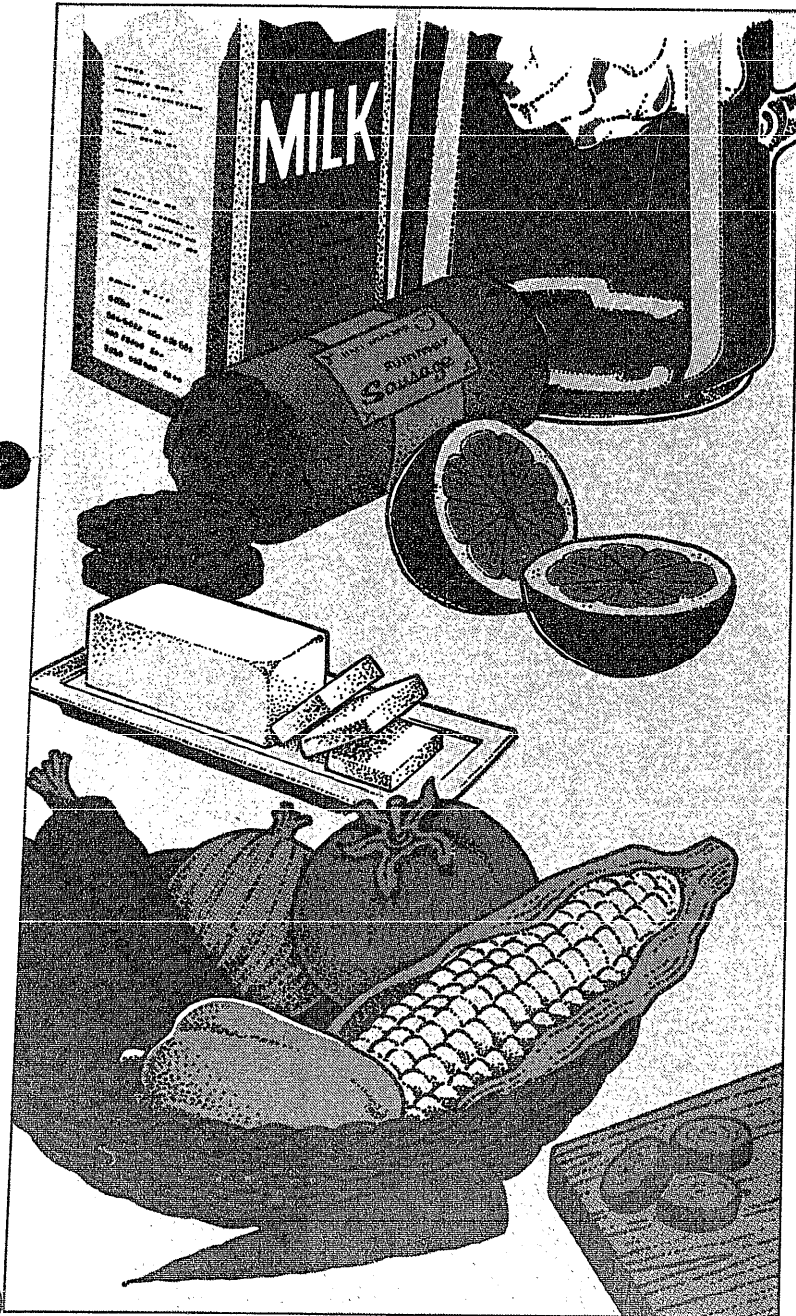

Use and Care of
No-Frost model
TBX23

Energy-saving tips p2

How the Energy Saver
Switch works p5

How long should you
store foods? p6

Questions?
Use the Problem Solver p12

49-6514

Your Direct Line to General Electric
The GE Answer Center™ 800.626.2000

EFFDATE 01-16-86

GENERAL  ELECTRIC

Contents

Energy-Saving Tips 2
Important Safety Instructions . . . 3
How to Connect Electricity . . . 3, 4
Installation Requirements 3, 4
How to Adjust Rollers 4
How to Set Temperature Controls 5
How to Use Energy Saver Switch 5
Food Storage Suggestions 6
Food-Saver System 7
How to Adjust Shelves 8-10
Ice Service 10
Accessories 10
User Maintenance Instructions 11
The Problem Solver 12, 13
If You Need Service 15
Warranty Back Cover

Help us help you...

Read this book carefully.

It is intended to help you operate and maintain your new refrigerator properly.

Keep it handy for answers to your questions.

If you don't understand something or need more help, write (include your phone number):

Consumer Affairs
General Electric Company
Appliance Park
Louisville, KY 40225

To obtain Hispanic version of this book, call The GE Answer Center® 800.626.2000 consumer information service. Toll-free.

Para obtener la versión en español de este manual, llame gratis a The GE Answer Center®, servicio de información para el consumidor, teléfono 800.626.2000.

Write down the model and serial numbers.

You'll see them on a label at the bottom, just inside the fresh food compartment door.

These numbers are also on the Consumer Product Ownership Registration Card that came with your refrigerator.

Before sending in the registration card, please write these numbers here:

Model Number _____

Serial Number _____

Use these numbers in any correspondence or service calls concerning your refrigerator.

If you received a damaged refrigerator, immediately contact the dealer (or builder) that sold you the refrigerator.

Save time and money. Before you request service, check the Problem Solver on pages 12 and 13. It lists minor causes of operating problems that you can correct yourself.

Energy-Saving Tips

- Location of your refrigerator is important. Avoid locating it next to your range, a heating vent or where the sun will shine directly on it.
- Don't open the doors more often than necessary.
- Close the doors as soon as possible, particularly in hot, humid weather.
- Keep Energy Saver Switch in the left position unless moisture forms on the outside of the refrigerator.

- Be sure the doors are closed tightly. Before leaving the house or retiring for the night, check to be sure the doors haven't been left open accidentally.
- Store only those foods requiring refrigeration in your refrigerator.
- Wipe moisture from bottles and cartons before putting them in the refrigerator.

- Keep foods covered to reduce moisture buildup inside the refrigerator.
- If you turn the controls to the coldest position for quick chilling or freezing, be sure to turn them back to regular settings.
- Don't overcrowd your refrigerator. Overcrowding can require extra electrical energy to keep everything cool.

IMPORTANT SAFETY INSTRUCTIONS

Read all instructions before using this appliance.

WARNING—When using this appliance, always exercise basic safety precautions, including the following:

- Use this appliance only for its intended purpose as described in this Use and Care Book.
- This refrigerator must be properly installed in accordance with the Installation Instructions before it is used. See grounding instructions below and on page 4.
- Never unplug your refrigerator by pulling on the power cord. Always grip plug firmly and pull straight out from the outlet.
- Repair or replace immediately all electric service cords that have become frayed or otherwise damaged. Do not use a cord that shows cracks or abrasion damage along its length or at either the plug or connector end.
- When moving your refrigerator away from the wall, be careful not to roll over or damage the power cord.
- After your refrigerator is in operation, do not touch the cold surfaces, particularly when hands are damp or wet. Skin may adhere to these extremely cold surfaces.

- If your refrigerator has an automatic icemaker, do not place fingers or hands on the automatic icemaking mechanism while the refrigerator is plugged in. This will prevent contact with the moving parts of the ejector mechanism, or with the heating element that releases the cubes.

- Don't refreeze frozen foods which have thawed completely. The United States Department of Agriculture in Home and Garden Bulletin No. 69 says:

"... You may safely refreeze frozen foods that have thawed if they still contain ice crystals or if they are still cold—below 40°F.

"... Thawed ground meats, poultry or fish that have any off-odor or off-color should not be refrozen and should not be eaten. Thawed ice cream should be discarded. If the odor or color of any food is poor or questionable, get rid of it. The food may be dangerous to eat.

"Even partial thawing and refreezing reduce the eating quality of foods, particularly fruits, vegetables and prepared foods. The eating quality of red meats is affected less than

that of many other foods. Use refrozen foods as soon as possible to save as much of their eating quality as you can."

- If your old refrigerator is still around the house but not in use, be sure to remove the doors. This will reduce the possibility of danger to children.

- Unplug your refrigerator:

A. Before making any repairs.

Note: We strongly recommend that any servicing be performed by a qualified individual.

B. Before cleaning.

C. Before replacing a burned-out light bulb, the refrigerator should be unplugged in order to avoid contact with a live wire filament. (A burned-out light bulb may break when being replaced.)

Note: Turning control to OFF position does not remove power to the light circuit.

- Do not operate your refrigerator in the presence of explosive fumes.

SAVE THESE INSTRUCTIONS

Installation Requirements—IMPORTANT... Please Read Carefully.

How to connect electricity

For personal safety, this appliance must be properly grounded.

The power cord of this appliance is equipped with a three-prong (grounding) plug which mates with a standard three-prong (grounding) wall outlet (Fig. 1) to minimize the possibility of electric shock hazard from this appliance.

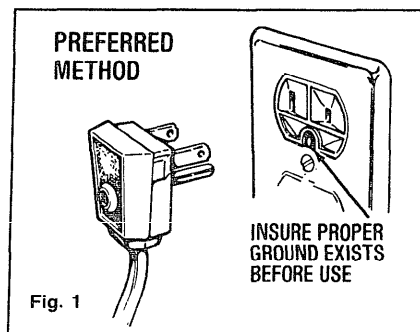

Have wall outlet and circuit checked by qualified electrician to make sure outlet is properly grounded.

Where a standard two-prong wall outlet is encountered, it is your personal responsibility and obligation to have it replaced with a properly grounded three-prong wall outlet.

DO NOT, UNDER ANY CIRCUMSTANCES, CUT OR REMOVE THE THIRD (GROUND) PRONG FROM THE POWER CORD.

(continued next page)

Installation Requirements (continued)—IMPORTANT... Please Read Carefully

Use of Adapter Plug

Because of potential safety hazards under certain conditions, we strongly recommend against use of an adapter plug. However, if you still elect to use an adapter, where local codes permit, a **TEMPORARY CONNECTION** may be made to a properly grounded two-prong wall outlet by use of a UL listed adapter (Fig. 2) available at most local hardware stores.

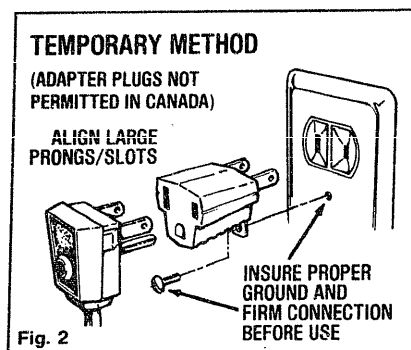

The larger slot in the adapter must be aligned with the larger slot in the wall outlet to provide proper polarity in the connection of the power cord.

CAUTION: Attaching the adapter ground terminal to the wall outlet cover screw does not ground the appliance unless the cover screw is metal, and not insulated, and the wall outlet is grounded through the house wiring. You should have the circuit checked by a qualified electrician to make sure the outlet is properly grounded.

When disconnecting the power cord from the adapter, always hold the adapter with one hand. If this is not done, the adapter ground terminal is very likely to break with repeated use.

Should the adapter ground terminal break, DO NOT USE the appliance until a proper ground has again been established.

Use of Extension Cords

Because of potential safety hazards under certain conditions, we strongly recommend against the use of an extension cord. However, if you still elect to use an extension cord, it is absolutely necessary that it be a UL listed 3-wire grounding type appliance extension cord having a grounding type plug and outlet and that the electrical rating of the cord be 15 amperes (minimum) and 120 volts. Such extension cords are obtainable through your local service organization.

The refrigerator should always be plugged into its own individual electrical outlet— (115 volt, 60 Hertz, or 100 volt, 50 Hertz, single phase AC). This is recommended for best performance and to prevent overloading house wiring circuits, which could cause a fire hazard from overheating wires.

Refrigerator location

Do not install refrigerator where temperature will go below 60°F, because it will not run often enough to maintain proper temperatures.

Do install it on a floor strong enough to support a fully loaded refrigerator.

Also see Energy-Saving Tips regarding location.

Clearances

Allow the following clearances for ease of installation and proper air circulation.

Sides	3/4"
Top	1"
Back	1"

When building a new home

Consider providing a water supply to the refrigerator location. It will simplify connection of an optional automatic icemaker should you wish to install one at a later date.

Rollers

Adjustable rollers, which enable you to move your refrigerator away from the wall for cleaning, are located behind the base grille. These rollers should be set so the refrigerator is firmly positioned on the floor and the front is raised just enough that the doors close easily when opened about halfway.

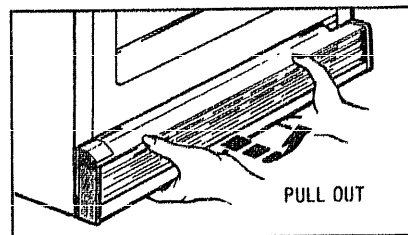

To adjust rollers, remove the base grille by grasping it at the bottom and pulling it out.

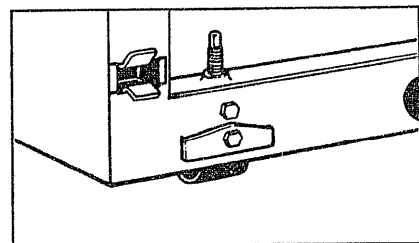

Turn roller adjusting screws clockwise to raise the refrigerator, counterclockwise to lower it. Use adjustable wrench (3/8" hex head bolt) or pliers.

When adjusting the front rollers for proper door closure, it is recommended that the bottom front edge of the cabinet be approximately 3/4" from the floor.

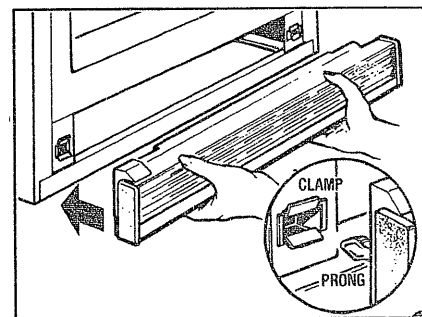

To replace base grille, align prongs on back of grille with clamps in cabinet and push forward until the grille snaps into place.

Operating Your Refrigerator

Set the Temperature Controls

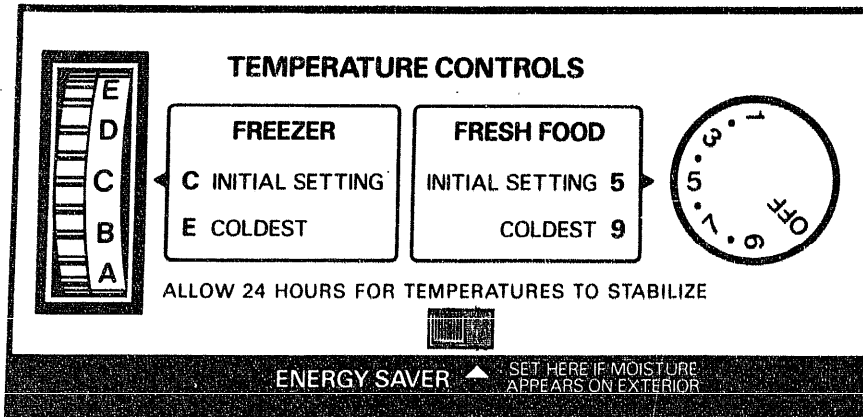

Your refrigerator has two controls that let you regulate the temperature in the fresh food and freezer compartments.

INITIALLY, set the **FRESH FOOD** control at **5** and the **FREEZER** control at **C**.

For colder or warmer temperatures, adjust the desired compartment control one letter or number at a time.

IMPORTANT: When initially setting controls, or adjusting them, allow 24 hours for temperatures to stabilize, or even out.

Note: Turning fresh food control to **OFF** position stops cooling in **BOTH** compartments—fresh food **AND** freezer—but does not shut off power to refrigerator.

How to test temperatures

Use the **milk test** for the **fresh food compartment**. Place a container of milk on the top shelf in the fresh food compartment. Check it a day later. If the milk is too warm or too cold, adjust the temperature controls.

Use the **ice cream test** for the **freezer compartment**. Place a container of ice cream in the center of the freezer compartment. Check it after a day. If it's too hard or too soft, adjust the temperature controls.

Always allow 24 hours for the refrigerator to reach the temperature you set.

If you turn your household thermostat below 60°F. at night

...you may want to turn the *lettered* control one step colder, as from "C" to "D." Cooler temperatures in the house may cause the compressor to operate less frequently, thus allowing the freezer compartment to warm somewhat. To protect your frozen food supply, leave your *lettered* setting at this colder setting for the entire winter or for whatever period of time you are turning down your thermostat. This is especially important when the thermostat is turned down for an extended period.

This change should have no effect on your fresh food compartment. However, if freezing occurs, turn the numbered control one step warmer, as from "5" to "4."

When you stop turning the thermostat down, turn temperature controls back to their regular settings.

Energy Saver Switch

The Energy Saver Switch is located on the temperature control panel.

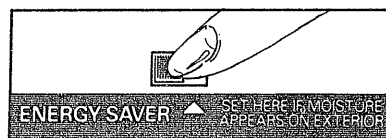

To reduce the amount of electricity required to operate your refrigerator, push switch to the left position.

This turns off heaters in your refrigerator that prevent moisture from forming on the outside.

Use of the Energy Saver Switch can save you money. Estimated yearly savings, depending on your local electric rates, are as follows:

Model	Estimated Yearly Savings			Energy Savings (Approx.)
	Electric Rate (Per Kwh)			
TBX23	\$.05	\$.08	\$.11	19%
	\$14.00	\$23.00	\$31.00	

With the heaters turned off, there is a chance that moisture may form on the outside of your refrigerator, especially when the weather is humid. The humidity is most likely to be high in the summer, in the early morning hours, and in homes which are not air conditioned.

Over an extended period of time, moisture that forms on the outside may cause deterioration of the paint finish. It will be important to protect the finish by using appliance polish or wax as described on page 11.

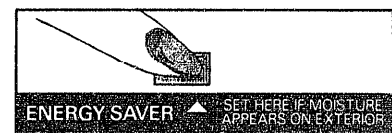

When the Energy Saver Switch is pushed to the right, electricity flows through the low wattage heaters which warm the outside of the cabinet and, under most conditions, prevent the forming of moisture or water droplets.

No Defrosting

It is not necessary to defrost the freezer or fresh food compartments. Your refrigerator is designed and equipped to defrost itself automatically.

Food Storage Suggestions

Suggested storage times for meat and poultry*

Eating quality drops after time shown	IN REFRIGERATOR	IN FREEZER
	AT 35° to 40°F. DAYS	AT 0°F. MONTHS
Fresh Meats		
Roasts (Beef & Lamb)	3 to 5	6 to 12
Roasts (Pork & Veal)	3 to 5	4 to 8
Steaks (Beef)	3 to 5	6 to 12
Chops (Lamb)	3 to 5	6 to 9
Chops (Pork)	3 to 5	3 to 4
Ground & Stew Meats	1 to 2	3 to 4
Variety Meats	1 to 2	3 to 4
Sausage (Pork)	1 to 2	1 to 2
Processed Meats		
Bacon	7	1
Frankfurters	7	½
Ham (Whole)	7	1 to 2
Ham (Half)	3 to 5	1 to 2
Ham (Slices)	3	1 to 2
Luncheon Meats	3 to 5	Freezing not recommended.
Sausage (Smoked)	7	
Sausage (Dry & Semi-Dry)	14 to 21	
Cooked Meats		
Cooked Meats and Meat Dishes	3 to 4	2 to 3
Gravy & Meat Broth	1 to 2	2 to 3
Fresh Poultry		
Chicken & Turkey (Whole)	1 to 2	12
Chicken (Pieces)	1 to 2	9
Turkey (Pieces)	1 to 2	6
Duck & Goose (Whole)	1 to 2	6
Giblets	1 to 2	3
Cooked Poultry		
Pieces (Covered with Broth)	1 to 2	6
Pieces (Not Covered)	3 to 4	1
Cooked Poultry Dishes	3 to 4	4 to 6
Fried Chicken	3 to 4	4
(Other than for meats & poultry) FREEZER		
Most fruits and vegetables		8-12 months
Lean fish		6-8 months
Fatty fish, rolls and breads, soups, stew, casseroles		2-3 months
Cakes, pies, sandwiches, left-overs (cooked)		
Ice cream (original carton)		1 month max.

New techniques are constantly being developed. Consult the College or County Extension Service or your local Utility Company for the latest information on freezing and storing foods.

*U.S. Department of Agriculture

Meats, fish and poultry purchased from the store vary in quality and age; consequently, safe storage time in your refrigerator will vary.

To store unfrozen meats, fish and poultry:

- Always remove store wrappings.
- Rewrap in foil, film or wax paper and refrigerate immediately.

To store cheese, wrap well with wax paper or aluminum foil, or put in a plastic bag.

- Carefully wrap to expel air and help prevent mold.
- Store pre-packaged cheese in its own wrapping if you wish.

To store vegetables, use the vegetable drawers—they've been designed to preserve the natural moisture and freshness of produce.

- Covering vegetables with a moist towel helps maintain crispness.
- As a further aid to freshness, pre-packaged vegetables can be stored in their original wrapping.

Note: Special fresh food compartment drawers (on models so equipped) make it unnecessary to wrap certain foods which they've been designed to preserve. These drawers are described on page 7.

To store ice cream—Fine-quality ice cream, with high cream content, will normally require slightly lower temperatures than more "airy" already-packaged brands with low cream content.

- It will be necessary to experiment to determine the freezer compartment location and temperature control setting to keep your ice cream at the right serving temperature.
- The rear of the freezer compartment is slightly colder than the front.

Tips on freezing foods

There are three essential requirements for efficient home freezing.

- 1. Initial quality.** Freeze only top-quality foods. Freezing retains quality and flavor; it cannot improve quality.
- 2. Speed.** The quicker fruits and vegetables are frozen after picking, the better the frozen product will be. You'll save time, too, with less culling and sorting to do.
- 3. Proper packaging.** Use food wraps designed especially for freezing; they're readily available at most food stores.

To freeze meat, fish and poultry, wrap well in freezer-weight foil (or other heavy-duty wrapping material) forming it carefully to the shape of the contents. This expels air. Fold and crimp ends of the package to provide a good, lasting seal.

Don't refreeze meat that has completely thawed; meat, whether raw or cooked, can be frozen successfully only once.

Limit freezing of fresh (unfrozen) meats or seafoods to 21 pounds at a time.

For convenience...

- Store like things together. This saves both time and electricity because you can find foods faster.
- Place the oldest items up front so they can be used up promptly.
- Use shelves on the door for most often used sauces and condiments.
- Use the Adjusta-Temp drawer, on models so equipped, for temporary storage of meats you do not freeze.

To save money in energy and food costs

- Place most perishable items, such as milk, cream or cottage cheese, toward the rear of the top shelf, as they will stay coldest in this part of the fresh food compartment.
- Cover moist foods with tight lids, plastic film or foil.
- Leaf vegetables and fruits placed in storage drawers will last longer when stored in closed plastic containers or wrapped in plastic film.
- Do not overload your fresh food or freezer compartment with a lot of warm food at once.
- Open the door the fewest times possible to save electrical energy.
- When going out of town for several days, leave as few perishables as possible in the refrigerator. If your refrigerator has an icemaker, set the icemaker to the OFF position and shut off water to the refrigerator.

General Electric Food-Saver System

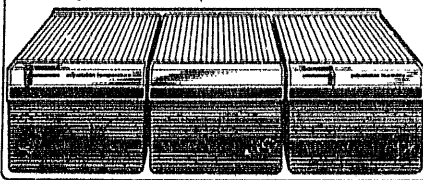
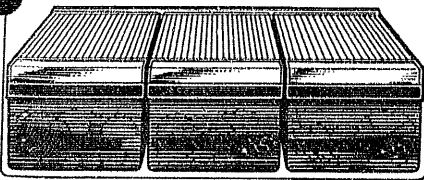

Cool'n Fresh Drawer

(on models so equipped)

This refrigerated drawer is designed to provide temporary lower humidity storage for items such as:

- Apples
- Oranges
- Squash,
- Apricots
- Peaches
- summer
- Grapes
- Pears
- Strawberries
- Mushrooms
- Raspberries
- Tangerines
- Nectarines

Moist'n Fresh Drawer

(on models so equipped)

This refrigerated drawer is designed to keep **unwrapped foods** fresh by retaining the natural moisture content of foods such as:

- Artichokes
- Cherries
- Plums
- Asparagus
- Corn
- Radishes
- Beets, topped
- Currants
- Rhubarb
- Blueberries
- Greens, leafy
- Spinach
- Carrots
- Lettuce
- Tomatoes, ripe
- Celery
- Parsley
- Peas, green

As in any refrigerated storage area, **it is recommended that odorous foods be stored wrapped**—foods

such as:

- Broccoli
- Cabbage
- Parsnips
- Brussels Sprouts
- Cauliflower
- Turnips
- Green Onions

Storage time will depend upon the type of food and its condition when placed in the drawer.

Excess water which may accumulate in the bottom of the Moist'n Fresh drawer should be poured out and the drawer wiped dry.

The Moist'n Fresh drawer is partially sealed by gaskets attached to the cover at the front and back edges.

Always replace the drawer in this cover and **push the drawer all the way in.**

Adjusta-Temp Drawer

(on models so equipped)

This drawer has an adjustable two-position temperature control which lets you regulate the amount of cold air entering the drawer.



When control is all the way to the left at the **"MEATS"** setting, baffle is fully open to provide coldest storage area.

When control is all the way to the right at the **"FRUITS"** setting, baffle is fully closed to provide normal refrigerator temperature.

Adjusta-Fresh Drawer

(on models so equipped)

This drawer has a second, inside cover. The adjustable humidity control lets you regulate the amount of cold air entering the drawer.

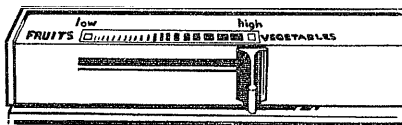

Slide the control all the way to the right to the **"VEGETABLES"** setting and the cover closes fully to provide a high humidity storage area.

Slide the control all the way to the left to the **"FRUITS"** setting and the cover stays partially open to provide a less humid storage area.

Variable settings between **"FRUITS"** and **"VEGETABLES"** can be selected as user desires.

Sealed Snack Pack

(on models so equipped)

The Sealed Snack Pack—and attached shelf—can be relocated within fresh food compartment. The sealed drawer retains high humidity for convenient storage of meats, cheese, bacon, hors d'oeuvres, spreads and snacks.

Drawer Removal

Drawers stop before coming all the way out, to help prevent contents from spilling onto floor. Drawers can be removed easily by tilting up slightly and pulling past "stop" location.

To remove drawers when the fresh food compartment door cannot be opened fully:

1. Remove drawer farthest from door, remove center drawer, lift their covers and pull them out.

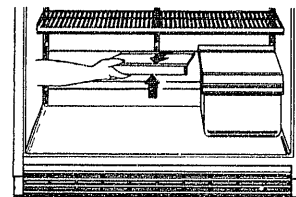

2. Slide remaining drawer and cover to the middle.

3. Pull drawer out until it hits the stops. Lift drawer slightly up and forward over the stops.

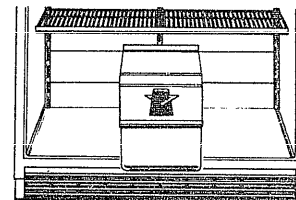

4. Place hand on drawer cover and pull out drawer.

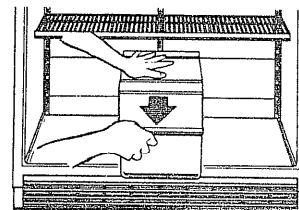

5. Lift cover and remove it.

Clean; replace in reverse order.

Shelves

How to rearrange your shelves

Adjustable Shelves in Fresh Food Compartment

Shelves in the fresh food compartment are adjustable in any combination, enabling you to make efficient shelf arrangements to fit your family's food storage needs.

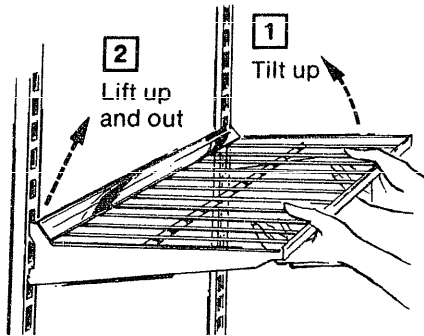

To remove shelves: Tilt shelf up at front, then lift it up and out of the track on rear wall of refrigerator.

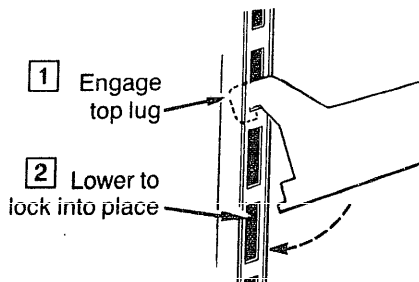

To replace shelves: Select desired shelf height. With shelf front raised slightly, engage top lugs in tracks at rear of cabinet. Then lower front of shelf until it locks into position.

Tempered glass shelves (on models so equipped) are adjustable in the same manner.

Spacemaker™ Door (on models so equipped)

Shelves on doors of General Electric refrigerators provide convenient storage for frequently used items.

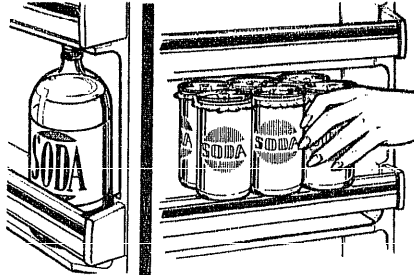

Deep shelves on Spacemaker™ Doors can accommodate a two-liter bottle on the bottom shelf and a six-pack on the shelf above it.

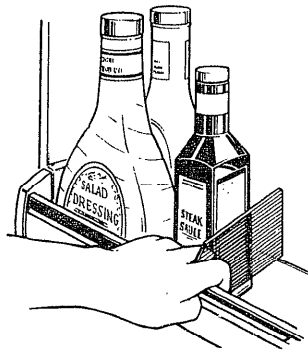

Snuggers, on models so equipped, are designed to give you storage flexibility on your fresh food door. Items such as salad dressings, steak sauces and other condiments can now be kept securely against the door liner to help prevent tipping, spilling or sliding.

For most efficient operation, place index finger and middle finger on either side of the snugger and simply move it back and forth to fit your needs.

Quick Serve System (on models so equipped)

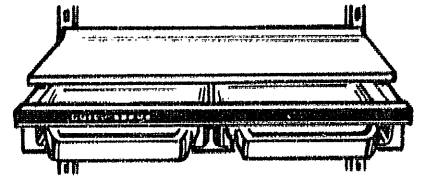

Cooking-serving-storage dishes with Lexan® see-through lids fit into a slide-out tray that, together with the shelf to which it attaches, can be relocated in the fresh food compartment.

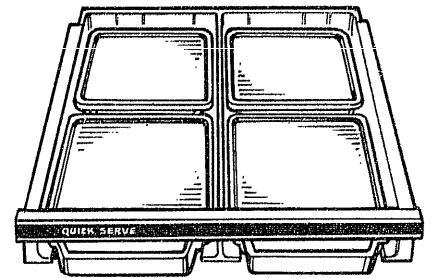

Dishes and lids are:

- safe for use in microwave ovens.
- safe for use in refrigerators and freezers.
- dishwasher safe.

Dishes only are safe for use in conventional ovens at temperatures up to 400° F.

CAUTION:

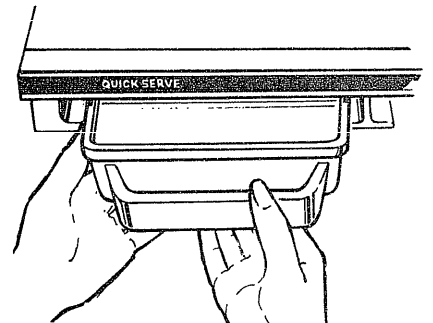

- Use both hands when removing a dish, especially when it is full. Otherwise, it may slip out of your grasp, fall and spill.
- Lids cannot withstand the heat generated in conventional ovens.
- Dishes and lids are not designed for range top cooking or broiler use. Such use can be hazardous.

Porta-Bins on Fresh Food Compartment Door

(on models so equipped)

Adjustable Porta-Bins can easily be carried from refrigerator to work area.

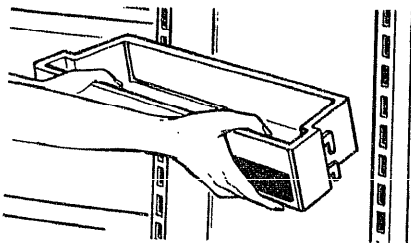

To remove: Lift Porta-Bin straight up until mounting hooks disengage.

To relocate: Select desired shelf height, engage Porta-Bin's hooks in slots on the tracks of the door, and push in. Porta-Bin will lock in place.

Ice Service Shelves

One shelf (on models so equipped) holds two ice cube trays up out of the way.

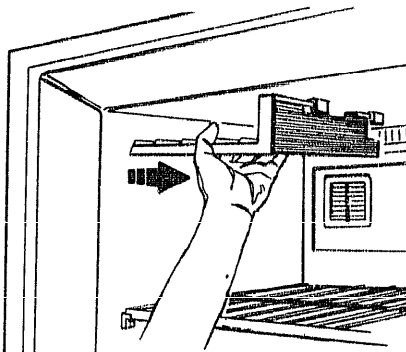

To remove shelf, pull it away from cabinet wall to disengage pins on shelf from holes in wall.

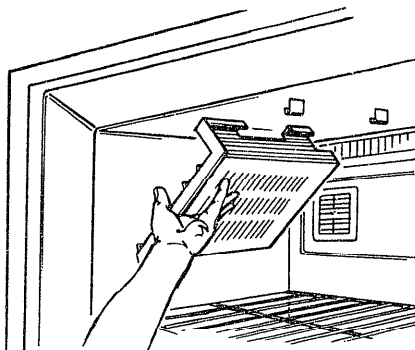

Then tilt shelf to disengage it from supports at top of freezer compartment, and take shelf out.

To replace, reverse procedure.

Two shelves (on models so equipped) hold four ice cube trays up out of the way.

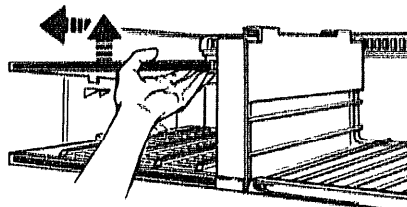

To remove the top shelf tray, tilt rear of shelf up until pins clear rear supports. Pull shelf forward and lift front until tabs clear front supports.

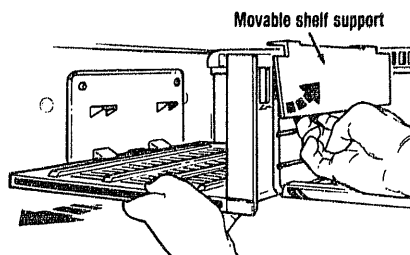

To remove bottom tray shelf, pull movable shelf support about 1/4" to the right with fingers of one hand. At the same time, pull shelf out with other hand.

To replace shelves, reverse procedure. Be sure to guide edge of bottom shelf into support channel on cabinet wall. Push shelf back until it is wedged in place on the left and locked in place by movable supports on the right.

Ice Service

Two-Position Shelf in Freezer Compartment

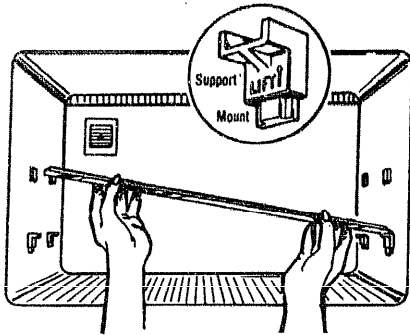

To remove shelf: Lift shelf off shelf supports, tilt it, and take it out.

To relocate shelf:

1. After removing shelf, remove shelf supports by sliding them upward. Replace them on other set of mounts.
2. Lower shelf onto relocated supports.

Partial-Width Shelf in Freezer Compartment

(on models so equipped)

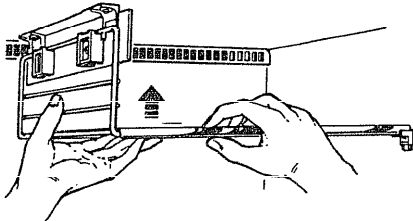

To remove shelf: Remove the two ice tray shelves as described at left. Then push up bottom of shelf until shelf snaps out of left-hand supports and off supports on cabinet wall.

To replace shelf: Set wire rack over left-hand supports and gently pull down on shelf until it snaps into place and rests on supports on cabinet walls.

Ice 'n Easy (on models so equipped)

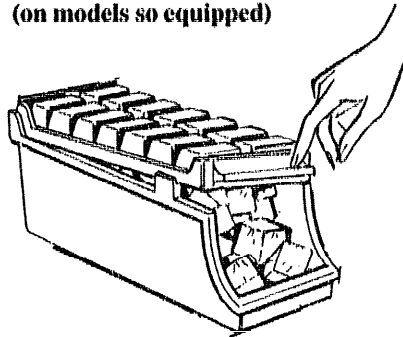

Ice trays are designed to release cubes easily into a companion ice storage bin. Just invert tray, insert one end into slot at rear of bin, press at front right side, and cubes will drop into bin.

Inverted tray may also be held over bin, and both ends twisted to release cubes.

Twice the Ice

(on models so equipped)

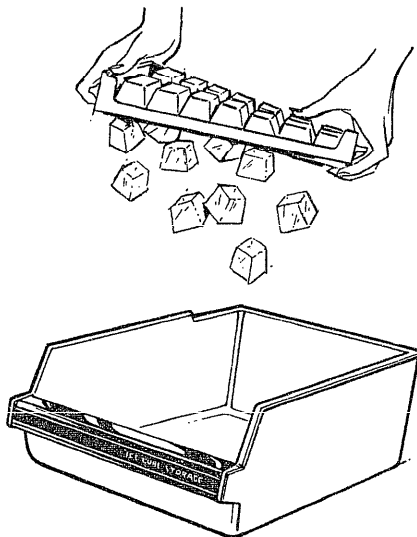

Cubes from four ice trays can be stored in the extra-wide bin that holds up to 10 pounds of ice.

For only one or two ice cubes, leave the tray right-side up, twist both ends slightly and remove desired number of cubes.

Wash ice trays and storage bin in lukewarm water only. Do not put them in an automatic dishwasher.

Accessories

Automatic Icemaker Accessory Kit

(optional at extra cost)

A GE automatic icemaker will replace the ice you use... automatically. It can keep you supplied with a binful of cubes—ice for everything, everybody—without fuss or muss.

If your refrigerator did not come already equipped with an automatic icemaker, you may add one—contact your local GE dealer; specify UK-KIT-1 or UK-KIT-2. A water supply kit containing copper tubing, shut-off valve, fittings and instructions needed to connect the icemaker to your cold water line is also available at extra cost.

The perfect companion to your automatic icemaker— Quadra Kleen Water Filter

Your ice cubes can only be as fresh-tasting as the water that produces them. That's why it's a good idea to purify your water with a Quadra Kleen Water Filter.

Its activated charcoal removes musty, stale odors and unpleasant medicinal, metallic tastes. A porous fiber cartridge catches dirt, rust particles, sand and silt while special crystals reduce deposits of hard scale.

The water filter is an option at extra cost and is available from your GE dealer. Specify WR97X214. It has complete installation instructions and installs in minutes on 1/4" O.D. copper water line.

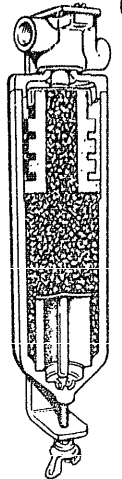

User Maintenance Instructions

Cleaning your refrigerator

Outside

The door handles and trim can be cleaned with a cloth dampened with a solution of mild liquid dishwashing detergent and water. Dry with a soft cloth. Don't use wax on the door handles or trim.

Keep the finish clean. Wipe with a clean cloth, lightly dampened with kitchen appliance wax or mild liquid dishwashing detergent. Dry and polish with a clean, soft cloth. Do not wipe the refrigerator with a soiled dishwashing cloth or wet towel. These may leave a residue that can erode the paint. Do not use scouring pads, powdered cleaners, bleach or cleaners containing bleach because these products can scratch and weaken the paint finish.

Protect the paint finish. The finish on the outside of the refrigerator is high quality, baked-on paint finish. With proper care, it will stay new-looking and rust-free for years. Apply a coat of kitchen appliance wax when the refrigerator is new, and then at least twice a year.

Appliance Polish Wax & Cleaner (Cat. No. WR97X216) is available from GE Appliance Parts Marts.

Inside

Inside of fresh food and freezer compartments should be cleaned at least once a year. Unplug the refrigerator before cleaning. If this is not practical, wring excess moisture out of sponge or cloth when cleaning around switches, lights or controls.

Use warm water and baking soda solution—about a tablespoon of baking soda to a quart of water. This both cleans and neutralizes odors. Rinse thoroughly with water and wipe dry.

Other parts of the refrigerator—including door gaskets, meat and vegetable drawers, ice storage bin and all plastic parts—can be cleaned the same way. Do not use cleansing powders or other abrasive cleaners.

Do not wash any of your refrigerator's plastic parts in your automatic dishwasher except Quick Serve dishes and lids.

Behind refrigerator

Care should be taken in moving your refrigerator away from the wall. All types of floor coverings can be damaged, particularly cushioned coverings and those with embossed surfaces. Pull the refrigerator straight out and return it to position by pushing it straight in. Moving your refrigerator in a side direction may result in damage to your floor covering or refrigerator.

Condenser

The condenser is located behind the base grille. For most efficient operation, you will need to keep the condenser clean. Remove the base grille (see page 4), and either sweep away or vacuum dust that is readily accessible. This easy cleaning operation should be done at least once a year.

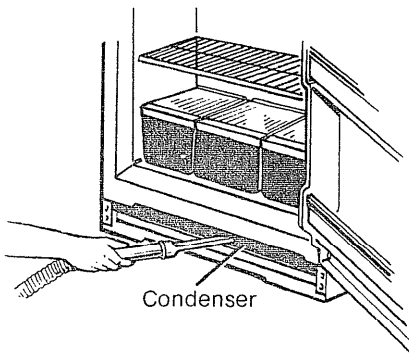

Light bulb replacement

A light bulb and socket are located behind a shield on each side of the temperature control panel.



To replace a light bulb, unplug the refrigerator's power cord plug from the wall outlet. Then reach up behind the shield, unscrew the burned-out bulb, and replace it with a standard 40-watt appliance bulb.

When you go on vacation

For extended vacations or absences, shut off power to refrigerator, turn the numbered control to OFF position, clean interior with baking soda solution of one tablespoon of soda to one quart of water. Wipe dry. To prevent odors, leave open box of soda in refrigerator. Leave doors open.

For shorter vacations, remove perishable foods and leave controls at regular settings. However, if room temperature is expected to drop below 60°F., follow same instructions as for extended vacations.

If you have an icemaker, set it to the OFF position and be sure to shut off water supply to refrigerator.

When you move

Disconnect power cord from wall outlet, remove all food and clean and dry the interior.

Secure all loose items such as grille, shelves, storage pans and ice trays by taping them securely in place to prevent damage.

Be sure refrigerator stays in *upright position only* during actual moving and in van. Refrigerator must be secured in van to prevent movement. Protect outside of refrigerator with blanket.



Questions? Use This Problem Solver

Rapid Electrical Diagnosis

Your refrigerator is wired for accurate electrical diagnosis in your home—takes only minutes for a service technician to check its entire electrical system. No need for the technician to unplug, move or unload the refrigerator to make the diagnosis.

PROBLEM	POSSIBLE CAUSE AND REMEDY
REFRIGERATOR DOES NOT OPERATE	<ul style="list-style-type: none">• May be in defrost cycle when motor does not operate for about 35 minutes.• Temperature control in OFF position.• If interior light is not on, refrigerator may not be plugged in at wall outlet.• If plug is secure and the refrigerator still fails to operate, plug a lamp or a small appliance into the same outlet to determine if there is a tripped circuit breaker or burned out fuse.
MOTOR OPERATES FOR LONG PERIODS	<ul style="list-style-type: none">• Modern refrigerators with more storage space and a larger freezer compartment require more operating time.• Normal when refrigerator is first delivered to your home—usually requires 24 hours to completely cool down.• Large amounts of food placed in refrigerator to be cooled or frozen.• Hot weather—frequent door openings.• Door left open.• Temperature controls are set too cold. Refer to instructions for use of TEMPERATURE CONTROLS on page 5.• Grille and condenser need cleaning. Refer to page 11.• Check ENERGY-SAVING TIPS on page 2.
MOTOR STARTS & STOPS FREQUENTLY	<ul style="list-style-type: none">• Temperature control starts and stops motor to maintain even temperatures.
VIBRATION OR RATTLING	<ul style="list-style-type: none">• If refrigerator vibrates, more than likely it is not resting solidly on the floor and front roller screws need adjusting, or floor is weak or uneven. Refer to ROLLERS on page 4.• If dishes vibrate on shelves, try moving them. Slight vibration is normal.
OPERATING SOUNDS	<ul style="list-style-type: none">• The high speed compressor motor required to maintain near zero temperatures in the large freezer compartment may produce higher sound levels than your old refrigerator.• Normal fan air flow—one fan blows cold air through the refrigerator and freezer compartments—another fan cools the compressor motor.• These NORMAL sounds will also be heard from time to time:<ul style="list-style-type: none">• Defrost timer switch clicks at defrost.• Defrost water dripping.• Temperature control clicks ON or OFF.• Refrigerant boiling or gurgling.• Cracking or popping of cooling coils caused by expansion and contraction during defrost and refrigeration following defrost.• With automatic icemaker, the sound of cubes dropping into the bin and water running in pipes as icemaker refills.

PROBLEM	POSSIBLE CAUSE AND REMEDY
HOT AIR FROM BOTTOM OF REFRIGERATOR	<ul style="list-style-type: none"> • Normal air flow cooling motor. <i>In the refrigeration process, it is normal that heat be expelled in the area under the refrigerator. Some floor coverings will discolor at these normal and safe operating temperatures. Your floor covering supplier should be consulted if you object to this discoloration.</i>
FRESH FOOD OR FREEZER COMPARTMENT TEMPERATURE TOO WARM	<ul style="list-style-type: none"> • Temperature control not set cold enough. Refer to TEMPERATURE CONTROLS on page 5. • Warm weather—frequent door openings. • Door left open for too long a time. • Package may be holding door open. • Package blocking air duct in freezer compartment.
FOODS DRY OUT	<ul style="list-style-type: none"> • Foods not covered, wrapped or sealed properly.
FROST OR ICE CRYSTALS ON FROZEN FOOD	<ul style="list-style-type: none"> • Door may have been left ajar or package holding door open. • Too frequent and too long door openings. • Frost within package is normal.
SLOW ICE CUBE FREEZING	<ul style="list-style-type: none"> • Door may have been left ajar. • Turn temperature of freezer compartment colder.
ICE CUBES HAVE ODOR/TASTE	<ul style="list-style-type: none"> • Old cubes need to be discarded. • Ice storage bin needs to be emptied and washed. • Unsealed packages in refrigerator and/or freezer compartments may be transmitting odor/taste to ice cubes. • Interior of refrigerator needs cleaning. Refer to page 11.
MOISTURE FORMS ON OUTSIDE OF REFRIGERATOR	<ul style="list-style-type: none"> • Not unusual during periods of high humidity. • Move the Energy Saver Switch to the right. <div data-bbox="991 1193 1422 1301" style="text-align: right; border: 1px solid black; padding: 5px;">  <p>ENERGY SAVER ▲ SET HERE IF MOISTURE APPEARS ON EXTERIOR</p> </div>
MOISTURE COLLECTS INSIDE	<ul style="list-style-type: none"> • Too frequent or too long door openings. • In humid weather, air carries moisture into refrigerator when doors are opened.
REFRIGERATOR HAS ODOR	<ul style="list-style-type: none"> • Foods with strong odors should be tightly covered. • Check for spoiled food. • Interior needs cleaning. Refer to page 11. • Defrost water system needs cleaning. • Keep open box of baking soda in refrigerator; replace monthly.

If you need more help...call, toll free:

The GE Answer Center®

800.626.2000

Consumer information service

If You Need Service

To obtain service, see your warranty on the back page of this book.

We're proud of our service and want you to be pleased. If for some reason you are not happy with the service you receive, here are three steps to follow for further help.

FIRST, contact the people who serviced your appliance. Explain why you are not pleased. In most cases, this will solve the problem.

NEXT, if you are still not pleased, write all the details—including your phone number—to:

Manager, Consumer Relations
General Electric
Appliance Park
Louisville, Kentucky 40225

FINALLY, if your problem is still not resolved, write:

Major Appliance
Consumer Action Panel
20 North Wacker Drive
Chicago, Illinois 60606

YOUR GENERAL ELECTRIC REFRIGERATOR WARRANTY

Save proof of original purchase date such as your sales slip or cancelled check to establish warranty period.

WHAT IS COVERED

FULL ONE-YEAR WARRANTY

For one year from date of original purchase, we will provide, free of charge, parts and service labor in your home to repair or replace **any part of the refrigerator** that fails because of a manufacturing defect.

FULL FIVE-YEAR WARRANTY

For five years from date of original purchase, we will provide, free of charge, parts and service labor in your home to repair or replace **any part of the sealed refrigerating system** (the compressor, condenser, evaporator and all connecting tubing) that fails because of a manufacturing defect.

This warranty is extended to the original purchaser and any succeeding owner for products purchased for ordinary home use in the 48 mainland states, Hawaii and Washington, D.C. In Alaska the warranty is the same except that it is **LIMITED** because you must pay to ship the product to the service shop or for the service technician's travel costs to your home.

All warranty service will be provided by our Factory Service Centers or by our authorized Customer Care® servicers during normal working hours.

Look in the White or Yellow Pages of your telephone directory for **GENERAL ELECTRIC COMPANY, GENERAL ELECTRIC FACTORY SERVICE, GENERAL ELECTRIC-HOTPOINT FACTORY SERVICE** or **GENERAL ELECTRIC CUSTOMER CARE® SERVICE**.

WHAT IS NOT COVERED

- Service trips to your home to teach you how to use the product.

Read your Use and Care material.

If you then have any questions about operating the product, please contact your dealer or our Consumer Affairs office at the address below, or call, toll free:

The GE Answer Center®
800.626.2000

consumer information service

- Improper installation.

If you have an installation problem, contact your dealer or installer. You are responsible for providing adequate electrical, plumbing and other connecting facilities.

- Replacement of house fuses or resetting of circuit breakers.

- Failure of the product if it is used for other than its intended purpose or used commercially.

- Damage to product caused by accident, fire, floods or acts of God.

WARRANTOR IS NOT RESPONSIBLE FOR CONSEQUENTIAL DAMAGES.

Some states do not allow the exclusion or limitation of incidental or consequential damages, so the above limitation or exclusion may not apply to you. This warranty gives you specific legal rights, and you may also have other rights which vary from state to state. To know what your legal rights are in your state, consult your local or state consumer affairs office or your state's Attorney General.

Warrantor: General Electric Company

If further help is needed concerning this warranty, contact:

Manager—Consumer Affairs, General Electric Company, Appliance Park, Louisville, KY 40225

Part No. 468329P04
Pub. No. 49-6514

GENERAL  ELECTRIC

TBX23

Free Manuals Download Website

<http://myh66.com>

<http://usermanuals.us>

<http://www.somanuals.com>

<http://www.4manuals.cc>

<http://www.manual-lib.com>

<http://www.404manual.com>

<http://www.luxmanual.com>

<http://aubethermostatmanual.com>

Golf course search by state

<http://golfingnear.com>

Email search by domain

<http://emailbydomain.com>

Auto manuals search

<http://auto.somanuals.com>

TV manuals search

<http://tv.somanuals.com>