

Owner's Manual

Privacy Glass
Wine Reserve

ZDWT240



Introduction

Your new Monogram wine reserve makes an eloquent statement of style, convenience and kitchen planning flexibility. Whether you chose it for its purity of design or the assiduous attention to detail, you will find that your Monogram wine reserve's superior blend of form and function will delight you for years to come.

The information on the following pages will help you operate and maintain your wine reserve properly.

If you have any other questions, visit our Website at: **monogram.com**

Contents

Care and Cleaning	11, 12	Problem Solver	13-15
Consumer Services	19	Product Registration	2
Controls and Features	8-10	Repair Service	3, 19
Model and Serial Numbers	2	Safety Instructions	4-7
		Warranty	Back Cover

Before using your wine reserve

Read this manual carefully. It is intended to help you operate and maintain your new wine reserve properly.

Keep it handy for answers to your questions.

If you don't understand something or need more help, there is a list of toll-free consumer service numbers included in the back section of this manual.

OR

Visit our Website at: **monogram.com**

Write down the model & serial numbers

You will find them on a label on the ceiling inside the wine reserve.

Please write these numbers here:

Model Number

Serial Number

Use these numbers in any correspondence or service calls concerning your wine reserve.

ATTENTION CONSUMER!

**This unit is designed for storing and cooling beverages.
Do not store perishable foods in this unit.**

ATTENTION CONSOMMATEUR !

**Cet appareil ménager est conçu pour conserver et rafraîchir des boissons.
Ne mettez pas de biens perissables dans cet appareil ménager.**

If you received a damaged appliance

The warranty does not cover damage caused after delivery.

Immediately contact the dealer (or builder) that sold you the wine reserve.

Save time & money

Before you request service, check the Problem Solver in the back of this manual.

It lists causes of minor operating problems that you can correct yourself.

Remove packaging

Before using, be sure all packing materials and tape have been removed.
To assure no damage is done to the finish of the product, the safest way to remove the adhesive left from packaging tape on new

appliances is an application of household liquid detergent. Apply with a soft cloth and allow to soak. Wipe dry and then apply an appliance polish to thoroughly clean and protect the surface.

If you need service

To obtain service, see the Consumer Services page in the back of this manual.

We are proud of our service and want you to be pleased. If for some reason you are not happy with the service you receive, here are steps to follow for further help.

For customers in the USA:

FIRST, contact the people who serviced your appliance. Explain why you are not pleased. In most cases, this will solve the problem.

NEXT, if you are still not pleased, write all the details—including your phone number—to:

Manager, Customer Relations
GE Appliances
Appliance Park
Louisville, KY 40225

For customers in Canada:

FIRST, contact the people who serviced your appliance. Explain why you are not pleased. In most cases, this will solve the problem.

NEXT, if you are still not pleased, write all the details—including your phone number to:

Manager, Consumer Relations
Mabe Canada Inc.
1 Factory Lane, Suite 310
Moncton, N.B. E1C 9M3

After installation is completed

- The location should not be subject to direct sunlight, heat or moisture.
- Promptly inspect your new Monogram wine reserve. If it has been damaged, contact the Installer or Dealer immediately.
- This wine reserve must be properly leveled to ensure correct door alignment and door closure. Contact the Installer if the unit is not level.
- The unit should be centered in the opening. The front face of the door should be 1" forward of adjacent cabinetry. Contact the installer if clearance is not correct.

- Test the door swing. Carefully open and close the door. The door should not rub or catch on adjacent cabinetry. Notify the installer if the door makes contact with cabinetry.

Please Contact the Installer or Dealer if you experience any of these problems.

Your wine reserve is shipped with a black toekick on the front of the unit. For shipping purposes, an optional stainless steel toekick is secured to the back or on the inside of the unit. That toekick should have been removed and installed, or given to you. Keep the unused toekick and other unused or removed parts for possible future use.

IMPORTANT SAFETY INSTRUCTIONS

READ AND SAVE THESE INSTRUCTIONS

BEFORE IT IS USED, THE APPLIANCE MUST BE PROPERLY INSTALLED AND LOCATED AS DESCRIBED IN THIS MANUAL.

▲ DANGER: RISK OF CHILD ENTRAPMENT

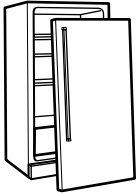

Child entrapment and suffocation are not problems of the past. Junked or abandoned refrigeration products are still dangerous...even if they will sit for "just a few days." If you are getting rid of your old appliance, please follow these instructions to help prevent accidents.

Before You Throw Away Your Old Refrigeration Product:

- Take off the doors.
 - Leave the shelves in place so that children may not easily climb inside.
-

REFRIGERANTS

All refrigeration products contain refrigerants, which under federal law must be removed prior to product disposal.

If you are getting rid of an old refrigeration product, check with the company handling the disposal about what to do.

DO NOT USE AN ADAPTER PLUG OR EXTENSION CORD (Adapter plugs not permitted in Canada)

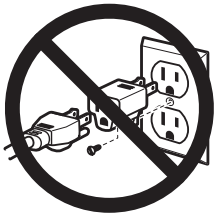

Do not use an adapter plug to connect the refrigerator to a 2-prong outlet.

Do not use an extension cord with this appliance.

IMPORTANTES INSTRUCTIONS DE SÉCURITÉ

LIRE ET CONSERVER CES INSTRUCTIONS

AVANT D'ÊTRE UTILISÉ, L'APPAREIL MÉNAGER DOIT ÊTRE BIEN INSTALLÉ ET SE TROUVER À L'ENDROIT DÉCRIT DANS CETTE MANUEL.

▲ DANGER! RISQUES POUR LES ENFANTS

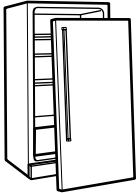

Les enfants pris au piège ou morts d'asphyxie sont toujours d'actualité. Les appareils de réfrigération abandonnés sont toujours aussi dangereux, même si on n'attend que "quelque jours" pour s'en débarrasser. Si vous ne gardez pas votre ancien appareil, veuillez suivre les directives ci-dessous afin de prévenir les accidents.

Avant de vous débarrasser de votre vieux appareil de réfrigération :

- Démontez les portes.
- Laissez les clayettes en place afin d'empêcher les enfants de grimper à l'intérieur.

RÉFRIGÉRANTS

Tous les appareils de réfrigération contiennent des réfrigérants qui, conformément aux lois fédérales, doivent être enlevés avant toute élimination de l'appareil.

Si vous vous débarrassez de vieux appareils de réfrigération, vérifiez, auprès de la société qui s'occupe de leur élimination, ce que vous devez faire.

NE PAS UTILISER DE FICHE D'ADAPTATION OU DE CORDON PROLONGATEUR

(Fiches d'adaptation non permises au Canada)

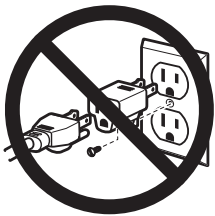

N'utilisez pas de fiche d'adaptation pour brancher le réfrigérateur dans une prise à 2 broches.

N'utilisez pas de cordon prolongateur avec cet appareil.

IMPORTANT SAFETY INSTRUCTIONS

HOW TO CONNECT ELECTRICITY

Do not, under any circumstances, cut or remove the third (ground) prong from the power cord. For personal safety, this appliance must be properly grounded.

The power cord of this appliance is equipped with a 3-prong (grounding) plug which mates with a standard 3-prong (grounding) wall outlet to minimize the possibility of electric shock hazard from this appliance.

Have the wall outlet and circuit checked by a qualified electrician to make sure the outlet is properly grounded.

Where a standard 2-prong wall outlet is encountered, it is your personal responsibility and obligation to have it replaced with a properly grounded 3-prong wall outlet.

The appliance should always be plugged into its own individual electrical outlet which has a voltage rating that matches the rating plate. This provides the best performance and also prevents overloading house wiring circuits which could cause a fire hazard from overheated wires.

Never unplug an appliance by pulling on the power cord. Always grip the plug firmly and pull straight out from the outlet.

Repair or replace immediately all power cords that have become frayed or otherwise damaged. Do not use a cord that shows cracks or abrasion damage along its length or at either end.

When moving the appliance, be careful not to roll over or damage the power cord.

SAVE THESE INSTRUCTIONS

RACCORDEMENT ÉLECTRIQUE

Ne coupez ni retirez en aucun cas la troisième broche (mise à la terre) de la fiche du cordon d'alimentation. Pour votre sécurité, cet appareil doit être correctement mis à la terre.

Le cordon d'alimentation de cet appareil est muni d'une fiche à 3 broches (mise à la terre) qui se branche dans une prise mural ordinaire à 3 alvéoles (mise à la terre) pour réduire au minimum les risques de chocs électriques.

Faites examiner la prise de courant et le circuit par un électricien qualifié pour vous assurer que la prise est correctement mise à la terre.

Si la prise murale est du type standard à 2 alvéoles, il vous incombe de la faire remplacer par une prise à 3 alvéoles correctement mise à la terre.

La machine à glaçons doit toujours être branché dans sa propre prise de courant, dont la tension nominale est identique à celle indiquée sur la plaque signalétique.

Cette précaution est recommandée pour garantir un rendement optimum et éviter une surcharge des circuits électriques de la résidence, ce qui pourrait créer un risque d'incendie par surschauffe des fils.

Ne débranchez jamais l'appareil en tirant le cordon d'alimentation. Saisissez fermement la fiche du cordon et tirez droit pour la retirer de la prise.

Réparez ou remplacez immédiatement tout cordon effiloché ou endommagé. N'utilisez pas un cordon fendillé ou présentant des signes d'usure.

Lorsque vous déplacez l'appareil du mur, faites attention de ne pas la faire rouler sur le cordon d'alimentation afin de ne pas l'endommager.

CONSERVEZ CES DIRECTIVES

Temperature control



The temperature range of the wine reserve is from 40°F to 65°F.

Do not install the wine reserve where the temperature will go below 55°F or above 90°F.

The temperature display shows the actual temperature of the wine reserve. The actual temperature may vary slightly from the set temperature based on factors such as door openings, amount of wine and room temperature. After making adjustments, allow 12 to 24 hours for the wine reserve to reach the temperature you have set and before making any further adjustments. The factory setting is the RED WINE setting (55°F).

Note: On all three temperature selections, the light beside the pad will remain lit, indicating the selection made.

The RED WINE setting will provide a storage temperature of approximately 55°F, which is optimum for the storage of red wine. Press the RED WINE pad to display 55°F. Several seconds after the RED WINE pad is pressed, the actual temperature will be displayed while the wine reserve temperature moves toward 55°F.

The WHITE WINE setting will provide a storage temperature of approximately 45°F, which is optimum for white wine. Press the WHITE WINE pad to display 45°F. Several seconds after the WHITE WINE pad is pressed, the actual temperature will be displayed while the wine reserve temperature moves toward 45°F.

The CUSTOM setting will provide a storage temperature range of 40°F to 65°F. This setting provides the ability to customize the temperature to the optimum setting for the particular wine. To change the temperature setting, press and hold the CUSTOM pad until the display begins to flash the set temperature. Then press the + or - pads until you reach the desired set temperature. Once you reach the desired temperature, stop pressing the pads. After several seconds, the display will return to the actual temperature. The actual temperature will be displayed while the wine reserve moves toward the set temperature.

In general, temperatures at the bottom of the cabinet will be cooler than temperatures at the top of the cabinet.

Position your wine inventory accordingly (i.e., white wines in the cooler zones and red wines in the warmer zones).

Child control lockout

This child control lockout feature prevents unwanted changes to your temperature settings.

After the desired temperature is set the temperature can be locked. To lock, press both the + and - pads at the same time for five seconds. To unlock, press both + and - pads for five seconds.

Interior lighting and glass activation

The interior light makes it easy to view your wine labels and enhances the display of your collection. The privacy glass allows you to view your wine with a simple press of a button, without opening the door. These two features work jointly to display your wine.

Normal operation

When the door is opened, the light will come on and the door will become clear.

Special features

The light and glass activation button, located at the top of the handle, will switch the glass from opaque to clear and will, at the same time, turn on the light. The light will stay on and the glass will remain clear for one hour from the last time the button was pressed. To turn the light off and make the glass opaque, press the button again. The opaque setting conceals the contents from view. The light will come on only when the door is opened

or the button is pressed. If you choose to activate the light and door while the door is open, you may notice that the word ON is displayed. If you press the light button a second time, while the door is open the word OFF will be displayed.

For best viewing, do not store a bottle on the top shelf directly under the light. Remember to turn off the light when it is no longer needed.

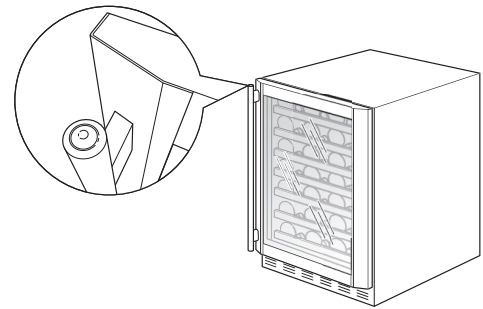

Removing full extension drawers

All of the full extension drawers pull out so bottles can be conveniently added or removed.

Any of the full extension drawers can be removed to store larger bottles.

To remove:

1. Pull the full extension drawer out to the STOP position.
2. Push the tab on right drawer guide down while pulling the tab on left guide up, and pull the drawer out.

To replace:

1. Push the drawer slide arm back into the unit.
2. Pull the small slide sub-assembly completely forward.
3. Insert the sides of the drawer back into the guides.
4. Push until the tabs lock into place.

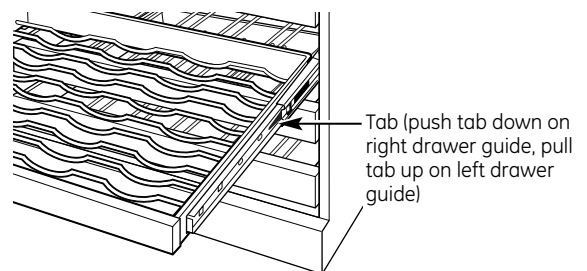

Appearance may vary

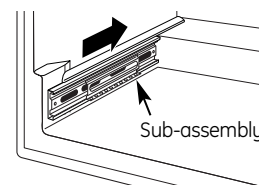

To replace, push drawer slide arm back into unit

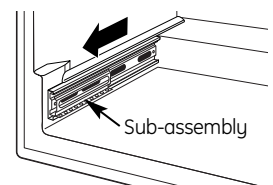

Pull small slide sub-assembly completely forward

NOTE: Make sure the tabs on the full extension drawer guides are fully engaged before loading any bottles. Pull the drawers out all the way to the STOP position and push back in several times to make sure locking tabs are properly engaged.

Insert wine bottles

The top five full extension drawers each hold eight bottles, two deep with the necks alternating front to back or nine bottles, alternating with necks pointing inward.

The bottom two full extension drawers hold six bottles each and are loaded with necks facing the rear. Tall bottles should not be loaded on the bottom drawer because they may prevent the door from closing.

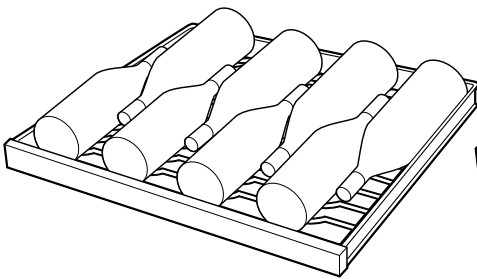

8 bottle arrangement

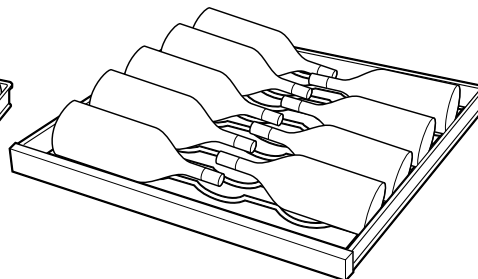

9 bottle arrangement

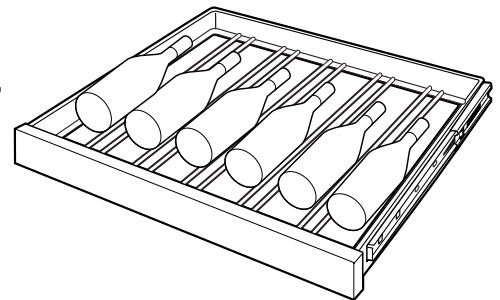

Bottom drawer

Loading tips and suggestions

- The bottles on the top full extension drawer, directly under the light, will be exposed to a slightly higher temperature when the light is on. Position your wines accordingly and remember to turn off the light when it is no longer needed.
- Keep wines that you plan to use for everyday drinking and entertaining on the front half of the full extension drawers where labels are completely visible. Place wines for aging or longer term storage in the rear.
- Do not allow children to climb, stand or hang on the wine reserve full extension drawers. They could seriously injure themselves and possibly cause damage to the wine reserve.
- In general, temperatures at the bottom of the cabinet will be cooler than temperatures at the top of the cabinet.
- Position your wine inventory accordingly (i.e., white wines in the cooler zones and red wines in the warmer zones).

Wood drawer fronts

The full extension drawer fronts on the wine reserve are unfinished cherry wood. During use, oil from hands may accumulate and stain the wood.

- The drawer fronts may be stained and sealed to match adjacent cabinetry. The tinted glass will make the stained wood appear darker. A true color match can be seen only when the door is opened.

- Apply the stain and sealer according to the manufacturer's instructions. To avoid unpleasant odor, keep the door open to ventilate and allow the stain/sealer to dry completely before using the product.

NOTE: Natural wood may vary slightly in grain and color.

For your safety

Unplug the wine reserve before cleaning. If the unit is in a built-in location, remove power at the circuit breaker.

Cleaning the inside

Unplug the wine reserve before cleaning. If the unit is in a built-in location, remove power at the circuit breaker. Use a slightly damp cloth or sponge when cleaning around switches, lights or controls.

Use warm water and baking soda solution—about a tablespoon (15 ml) of baking soda to a quart (1 liter) of water. This both cleans and neutralizes odors. Thoroughly rinse and wipe dry.

Other parts of the wine reserve center unit—including the door gaskets and full extension drawers—can be cleaned the same way.

Drain hole

Periodically check the drain hole and channel for any debris. If the drain is blocked, condensation will not drain properly.

To check and clean the drain hole, remove the third and fourth drawers (see instructions on *Removing full extension drawers*). Sweep a damp cloth along the channel in the back of the wine reserve. Use a finger to sweep away any debris from the drain hole.

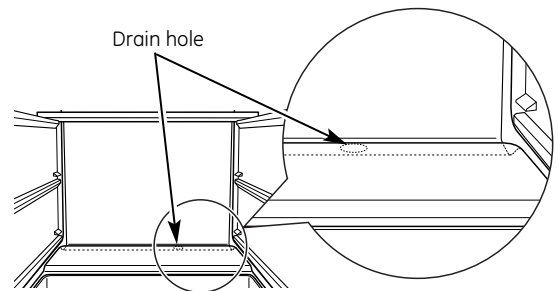

Appearance may vary

Cleaning the outside

The exterior surfaces can be washed with mild soap and water.

Rinse thoroughly with clear water. Never use abrasive scouring powders.

Do not use scouring pads, powdered cleaners, bleach or cleaners containing bleach because these products can scratch and damage the finish.

Warranty does not cover damage due to improper cleaning methods.

Glass door

Use a glass cleaner or mild soap and water and a soft cloth to clean the glass door. Do not use any abrasive powders.

Avoid cleaning cold glass with hot water because the extreme temperature difference may cause it to break. Rough handling of tempered glass can cause it to shatter.

Do not place magnets on or near the glass door. Magnets may cause permanent damage to the door.

Door gasket

The vinyl gasket may be cleaned with mild soap and water, a baking soda solution or a mild scouring powder. Rinse well.

After cleaning the door gasket, apply a thin layer of paraffin wax or petroleum jelly to the door gasket at the hinge side. This helps keep the gasket from sticking and bending out of shape.

For your safety

Unplug the wine reserve before cleaning. If the unit is in a built-in location, remove power at the circuit breaker.

Light bulb replacement

Unplug the wine reserve before replacing the light bulb. If the unit is in a built-in location, remove power at the circuit breaker.

To remove the light shield, push in the tab on the left side of the shield and lower it. Replace with a 15 watt appliance bulb.

In the event of a power failure

If the power fails, open the door as infrequently as possible to maintain the temperature. A gradual rise in temperature should not have any adverse effect on the wine.

If it is extremely hot, you may want to move the wine to the coolest location you can find until power is restored.

Do not store or use gasoline or other flammable vapors and liquids in the vicinity of this or any other appliance.

Preparing to move

Secure all loose items such as drawers by taping them securely in place to prevent damage.

Be sure the wine reserve stays in an upright position during moving.

Normal
operating
sounds

Newer appliances sound different from older appliances. Modern appliances have more features and use newer technology.

Do you hear what I hear? These sounds are normal.

**HUMMM...
WHOOSH...**

- The new high efficiency compressor may run faster and longer than your old appliance and you may hear a high-pitched hum or pulsating sounds while it is operating.
- Sometimes the appliance runs for an extended period, especially when the doors are opened frequently.
- You may hear a whooshing sound when the doors close. This is due to pressure equalizing within the appliance.



- You may hear the fans spinning at high speeds. This happens when the appliance is first plugged in, when the door is opened frequently or when large amounts of beverages are added to the appliance. The fans help maintain desired temperatures.
- If the door is open for over 3 minutes, you may hear a fan come on in order to cool the appliance.
- The fans change speeds in order to provide optimal cooling and energy savings.

**CLICKS, POPS,
CRACKS and CHIRPS**

- You may hear cracking or popping sounds when the appliance is first plugged in. This happens as the appliance cools to the correct temperature.
- Expansion and contraction of cooling coils during and after defrost can cause cracking or popping sounds.
- The electronic control board may cause a clicking sound when relays activate to control appliance components.

WATER SOUNDS



- The flow of refrigerant through the appliance cooling coils may make a gurgling noise like boiling water.
- A water dripping noise may occur as water from the evaporator flows into the drain pan.
- Closing the door may cause a gurgling sound due to pressure equalization.

Questions?
Use this
problem
solver!

PROBLEM	POSSIBLE CAUSE
APPLIANCE DOES NOT OPERATE	<ul style="list-style-type: none"> • Appliance is so quiet that most of the time you will hear low or no operating noise. • Appliance may be in defrost cycle when compressor motor does not operate for up to 2 hours. • If interior light is not on, appliance may not be plugged in at wall outlet. Push the plug completely into the wall outlet. • The fuse is blown/circuit breaker is tripped. Replace fuse or reset the breaker.
VIBRATION OR RATTLING (Slight vibration is normal.)	<ul style="list-style-type: none"> • Adjust the leveling legs as shown in the Installation Instructions.
COMPRESSOR MOTOR OPERATES FOR LONG PERIODS OR CYCLES ON AND OFF FREQUENTLY	<ul style="list-style-type: none"> • Normal when appliance is first plugged in. Wait 24 hours for the appliance to completely cool down. • Often occurs when large amounts of beverages are placed in appliance. This is normal. • Door left open or package holding door open. • Hot weather or frequent door openings. This is normal. • Temperature control set at the coldest setting. See Temperature Control. Allow 24 hours for temperature to change.
COMPARTMENT TOO WARM	<ul style="list-style-type: none"> • Temperature control not set cold enough. See Temperature Control. Allow 24 hours for temperature to change. • Warm weather or frequent door openings. • Door left open for long time. • Package may be holding door open.
APPLIANCE HAS ODOR	<ul style="list-style-type: none"> • Interior needs cleaning. See Care and Cleaning. • Keep open box of baking soda in appliance; replace every 3 months.
DOOR NOT CLOSING PROPERLY	<ul style="list-style-type: none"> • Door gasket is sticking or folding over. Apply petroleum jelly or paraffin wax to the face of the gasket. • The door is hitting an internal component inside the appliance. Adjust interior components to prevent interference.
MOISTURE FORMS ON OUTSIDE OF APPLIANCE	<ul style="list-style-type: none"> • Not unusual during periods of high humidity. If bothersome, wipe surface dry; otherwise, moisture will evaporate in time. • Door left open or package holding door open.
FROST OR MOISTURE COLLECTS INSIDE	<ul style="list-style-type: none"> • Too frequent or too long door openings. • In humid weather, air carries moisture into appliance when door is opened. Unit will dissipate moisture in time. If bothersome, wipe surface dry. • Temperature control set at coldest setting.
INTERIOR LIGHT DOES NOT WORK	<ul style="list-style-type: none"> • No power at outlet. • Light bulb needs replacing. See Care and Cleaning.

Questions?
Use this
problem
solver!

PROBLEM	POSSIBLE CAUSE
HOT AIR FROM BOTTOM OF APPLIANCE	<ul style="list-style-type: none"> • Normal air flow cools the motor. In the refrigeration process, it is normal that heat be expelled in the area under the appliance. Some floor coverings are sensitive and will discolor even at these safe and normal temperatures.
APPLIANCE NEVER SHUTS OFF BUT TEMPERATURES ARE OK	<ul style="list-style-type: none"> • Adaptive defrost keeps compressor running during door openings. This is normal. The appliance will cycle off after the door remains closed for two hours. • Normal operation in extreme temperatures.
TEMPERATURE WILL NOT ADJUST	<ul style="list-style-type: none"> • Temperature may be in lockout mode. Press both + and – pads for 5 seconds to unlock the temperature.
LIGHT REMAINS ON AND DOOR IS CLEAR WHILE DOOR IS CLOSED	<ul style="list-style-type: none"> • Normal operation. The light and door can be activated by pressing the button at the top of the handle. The light will remain on for one hour. Press the button to turn the door to opaque and turn the light off.
OPAQUE GLASS BECOMES CLEAR WHEN THE DOOR IS OPEN	<ul style="list-style-type: none"> • Normal operation. The light and glass features work jointly at all times. See <i>Interior lighting and glass activation in Controls and Features</i> section for more details.

With the purchase of your new Monogram appliance, receive the assurance that if you ever need information or assistance from GE, we will be there. All you have to do is call—toll-free!

GE Answer Center®

**In the USA:
800.626.2000**

Whatever your question about any Monogram major appliance, GE Answer Center® information service is available to help. Your call—and your question—will be answered promptly and courteously. And you can call any time. GE Answer Center® service is open 24 hours a day, Monday through Saturday.

OR

Visit our Website at: monogram.com

In Canada, call 1.800.561.3344.

In-Home Repair Service

**In the USA:
800.444.1845**

**In Canada:
1.800.561.3344**

A GE consumer service professional will provide expert repair service, scheduled at a time that's convenient for you. Many GE Consumer Service company-operated locations offer you service today or tomorrow, or at your convenience (7:00 a.m. to 10:00 p.m. weekdays, 8:00 a.m. to 6:00 p.m. Saturday and Sunday). Our factory-trained technicians know your appliance inside and out—so most repairs can be handled in just one visit. In Canada: Monday to Friday, 7:00 a.m. to 8:00 p.m. and Saturday, 8:00 a.m. to 5:00 p.m. EDST.

For Customers With Special Needs...

**In the USA:
800.626.2000**

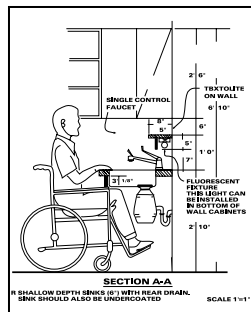

GE offers Braille controls for a variety of GE appliances, and a brochure to assist in planning a barrier-free kitchen for persons with limited mobility.

Consumers with impaired hearing or speech who have access to a TDD or a conventional teletypewriter may call 800.TDD.GEAC (800.833.4322) to request information or service.

Service Contracts

**In the USA:
800.626.2224**

**In Canada:
1.800.561.3344**

You can have the secure feeling that GE Consumer Service will still be there after your warranty expires. Purchase a GE contract while your warranty is still in effect and you'll receive a substantial discount. With a multiple-year contract, you are assured of future service at today's prices.

Parts and Accessories

**In the USA:
800.626.2002**

**In Canada:
1.800.561.3344**

Individuals qualified to service their own appliances can have parts or accessories sent directly to their home. The GE parts system provides access to over 47,000 parts...and all GE Genuine Renewal Parts are fully warranted. VISA, MasterCard and Discover cards are accepted.

User maintenance instructions contained in this manual cover procedures intended to be performed by any user. Other servicing generally should be referred to qualified service personnel. Caution must be exercised, since improper servicing may cause unsafe operation.

YOUR MONOGRAM WINE RESERVE WARRANTY
Staple sales slip or canceled check here. Proof of original purchase date is needed to obtain service under warranty.

WHAT IS COVERED

From the Date of the Original Purchase

LIMITED ONE-YEAR WARRANTY

For one year from date of original purchase, we will provide, free of charge, parts and service labor in your home to repair or replace *any part of the unit* that fails because of a manufacturing defect.

LIMITED FIVE-YEAR WARRANTY

For five years from date of original purchase, we will provide, free of charge, parts and service labor in your home to repair or replace *any part of the sealed refrigerating system* (the compressor, condenser, evaporator and all connecting tubing) that fails because of a manufacturing defect.

This warranty is extended to the original purchaser and any succeeding owner for products purchased for ordinary home use in the 48 mainland states, Hawaii, Washington, D.C. or Canada. If the product is located in an area where service by a GE Authorized Servicer is not available, you may be responsible for a trip charge or you may be required to bring the product to an Authorized GE Service location for service. In Alaska the warranty is the same except that it is LIMITED because you must pay to ship the product to the service shop or for the service technician's travel costs to your home.

All warranty service will be provided by our Factory Service Centers or by our authorized Customer Care® servicers during normal working hours.

Should your appliance need service, during warranty period or beyond, in the USA call 800.444.1845. In Canada: 800.561.3344. Please have your serial number and model number available when calling for service.

WHAT IS NOT COVERED

- Service trips to your home to teach you how to use the product.
- Replacement of house fuses or resetting of circuit breakers.
- Damage to the product caused by accident, fire, floods or acts of God.
- Failure of the product if it is used for other than its intended purpose or used commercially.
- Damage caused after delivery.
- Improper installation, delivery or maintenance. If you have an installation problem, contact your dealer or installer. You are responsible for providing adequate electrical, plumbing and other connecting facilities.
- Replacement of the light bulbs, if included.
- Loss of food due to spoilage (in the USA only).
- Incidental or consequential damage caused by possible defects with this appliance.
- Product not accessible to provide required service.

EXCLUSION OF IMPLIED WARRANTIES—Your sole and exclusive remedy is product repair as provided in this Limited Warranty. Any implied warranties, including the implied warranties of merchantability or fitness for a particular purpose, are limited to one year or the shortest period allowed by law.

Some states/provinces do not allow the exclusion or limitation of incidental or consequential damages, so the above limitation or exclusion may not apply to you. This warranty gives you specific legal rights, and you may also have other rights which vary from state to state/province to province. To know what your legal rights are in your state/province, consult your local or state/provincial consumer affairs office or your state's Attorney General.

**Warrantor in USA: General Electric Company,
Louisville, KY 40225**

**Warrantor in Canada: Mabe Canada Inc.,
Burlington, Ontario**

197D5891P016

49-60437-1

08-07 JR

Printed in Slovenia



GE Consumer & Industrial
Appliances
General Electric Company
Louisville, KY 40225
ge.com

Free Manuals Download Website

<http://myh66.com>

<http://usermanuals.us>

<http://www.somanuals.com>

<http://www.4manuals.cc>

<http://www.manual-lib.com>

<http://www.404manual.com>

<http://www.luxmanual.com>

<http://aubethermostatmanual.com>

Golf course search by state

<http://golfingnear.com>

Email search by domain

<http://emailbydomain.com>

Auto manuals search

<http://auto.somanuals.com>

TV manuals search

<http://tv.somanuals.com>