



Monogram®

## ZIDI240PII – GE Monogram Double-Drawer Refrigerator Module (Custom panel required)

## ZIDS240PSS – GE Monogram Double-Drawer Refrigerator Module (Stainless steel)

### Dimensions and Specifications (in inches)

#### Installation Space

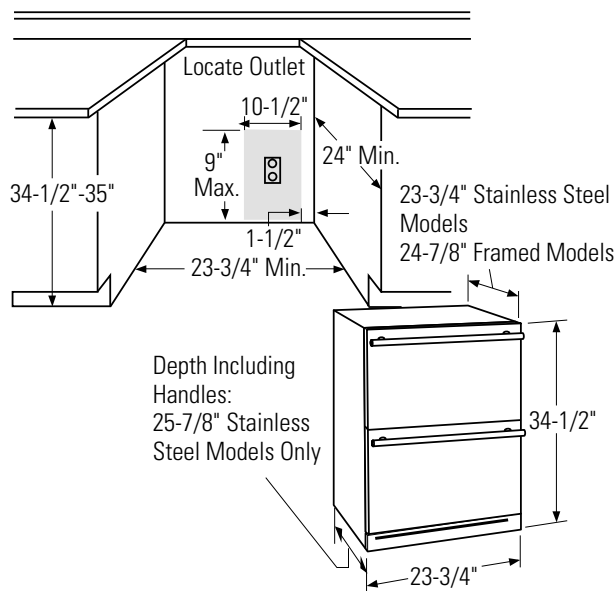

#### The cutout depth must be 24"

- Both models can be installed flush with standard cabinetry
- Designed to be built-in only. Cannot be used free-standing.
- White case and drawer sides, black vented toekick with optional stainless steel toekick supplied.

#### Additional Specifications:

- A 120 volt 60Hz., 15 or 20 amp power supply is required. An individual property grounded branch circuit or circuit breaker is recommended. Install a properly grounded 3-prong electrical receptacle recessed into the back wall as shown. Electrical must be located on rear wall as shown. **Note:** GFI (ground fault interrupter) is not recommended.

For a complete food storage center, install two Monogram refrigeration modules side-by-side.

**Note:** Reversible door swing on wine chillers/reserves and beverage centers only. See below for combination cutout dimensions.

**Important Note:** Products must operate from separate, properly grounded receptacles.

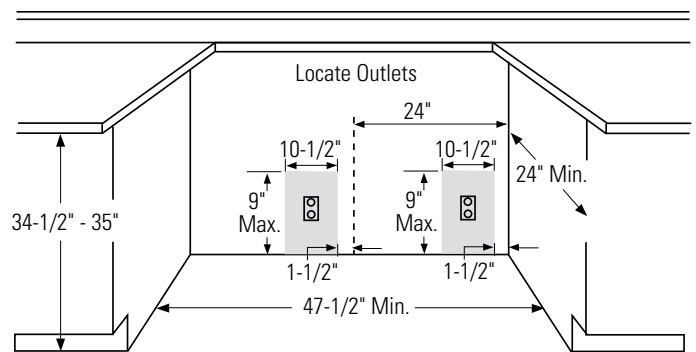

**Note:** Additional cutout width may be required for models with custom panels.

Specification Created 3/04

120030



Listed by  
Underwriters  
Laboratories

For answers to your Monogram®, GE Profile™ or GE® appliance questions, visit our website at [GEAppliances.com](http://GEAppliances.com) or call GE Answer Center® service, 800.626.2000.



Monogram®

## ZIDI240PII – GE Monogram Double-Drawer Refrigerator Module (Custom panel required)

## ZIDS240PSS – GE Monogram Double-Drawer Refrigerator Module (Stainless steel)

### Grounding the Double-Drawer Refrigerator

IMPORTANT – (Please read carefully)

FOR PERSONAL SAFETY, THIS APPLIANCE MUST BE PROPERLY GROUNDED.

The power cord of this appliance is equipped with a 3-prong (grounding) plug which mates with a standard 3-prong (grounding) wall receptacle to minimize the possibility of electric shock hazard from this appliance.

Have the wall outlet and circuit checked by a qualified electrician to make sure the outlet is properly grounded.

When a standard 2-prong wall outlet is encountered, it is your personal responsibility and obligation to have it replaced with a properly grounded 3-prong wall out.

DO NOT, UNDER ANY CIRCUMSTANCES, CUT OR REMOVE THE THIRD (GROUND) PRONG FROM THE POWER CORD.

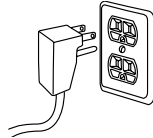

DO NOT USE AN ADAPTER PLUG TO CONNECT THE REFRIGERATOR TO A 2-PRONG OUTLET.

DO NOT USE AN EXTENSION CORD WITH THIS APPLIANCE.

### 3/4" Overlay Panel Dimensions

Model ZIDI240PII requires customer-provided overlay drawer panels.

- The overlay panels must be secured to a 1/4" thick backer panel which slides into the trim. A .10" thick spacer panel must be placed between the custom and backer panel.
- Custom handles of your choice, supplied by your cabinet maker, must be installed on the overlay panels.

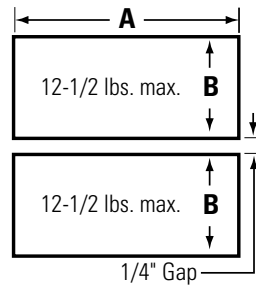
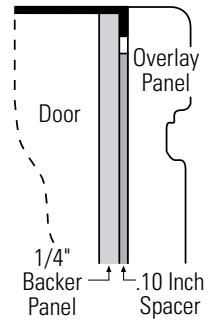

### 3/4" Overlay Panel Dimensions (in inches)

	A (Width)	B (Height)
1/4" Backer	23-3/16"	14-11/16"
0.10" Spacer	22-1/2"	14-3/16"
3/4" Overlay	23-5/8"	15-1/16"

NOTE: Max. assembled drawer panel weight is 25 lbs. (12-1/2 lbs. each panel).

IMPORTANT: Maintain a 1/4" gap between the panels when installed.

Assemble overlay panels with glue and screws.

- Center spacer panel on the backer panel, left to right and top to bottom. Secure the panels with glue.
- Center the spacer/backer panel on the overlay panel. Secure with glue and screws. Countersink screws into the backer panel.

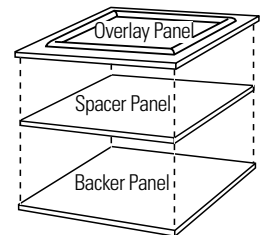

Listed by  
Underwriters  
Laboratories

For answers to your Monogram®, GE Profile™ or GE® appliance questions, visit our website at [GEAppliances.com](http://GEAppliances.com) or call GE Answer Center® service, 800.626.2000.

Specification Created 3/04

120030



**Monogram®**

**ZIDI240PII – GE Monogram Double-Drawer Refrigerator Module  
(Custom panel required)**

**ZIDS240PSS – GE Monogram Double-Drawer Refrigerator Module  
(Stainless steel)**

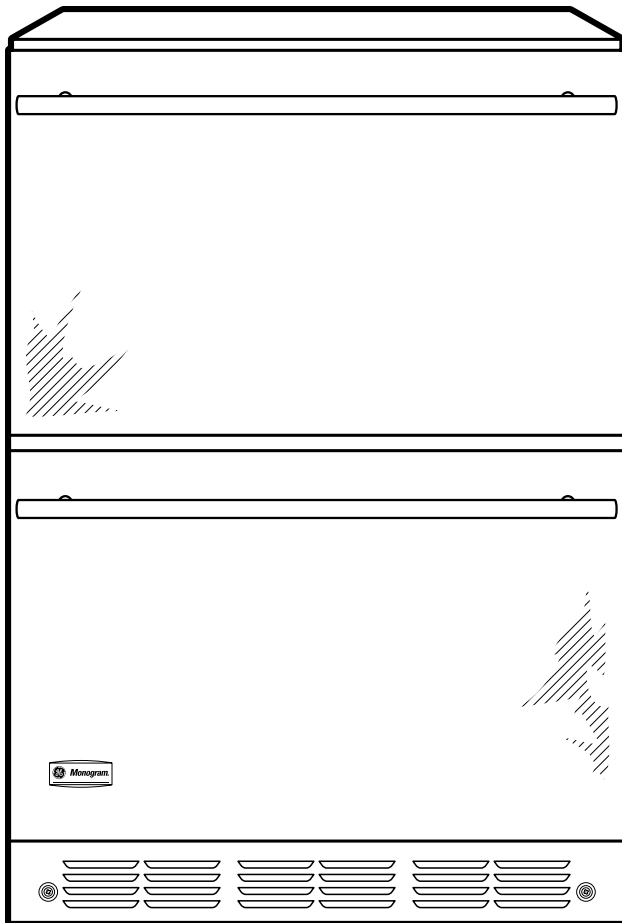

**Features and Benefits**

- Full-extension slide-out refrigerated drawers – Storage for everything from whole melons to 146 12 oz. cans
- Electronic adjustable temperature control –Offers a range of temperatures for precise chilling
- LED temperature display – Allows you to monitor the temperature at a glance
- Full-width LED lighting – Puts contents into clear view
- Custom panel and handle required – Customer must install a custom door panel and handle to complement their décor (ZIDI240PII only)
- Adjustable dividers – Maximizes usable storage space and flexibility
- Removable drawer bin – Convenient for separating loose items
- Fold-down shelf – Maximizes usable storage space
- Model ZIDS240PSS – Stainless steel
- Model ZIDI240PII – Custom panels and handles required

## Free Manuals Download Website

<http://myh66.com>

<http://usermanuals.us>

<http://www.somanuals.com>

<http://www.4manuals.cc>

<http://www.manual-lib.com>

<http://www.404manual.com>

<http://www.luxmanual.com>

<http://aubethermostatmanual.com>

Golf course search by state

<http://golfingnear.com>

Email search by domain

<http://emailbydomain.com>

Auto manuals search

<http://auto.somanuals.com>

TV manuals search

<http://tv.somanuals.com>