



Trash Compactors

Safety Instructions2-3

Operating Instructions

Compacting6
Features4
Loading5
Removing a Full Trash Bag6
Trash Bag Installation5
Using the Trash Compactor5-6

Care and Cleaning

Cleaning the Unit7

Troubleshooting Tips 8

Consumer Support

Consumer Support Back Cover
Product Registration
for Customers in Canada 11, 12
Product Registration
for Customers in the U.S.A. 9, 10
Warranty 15

Owner's Manual

GCG1500
GCG1580
GCG1700

Write the model and serial numbers here:

Model # _____

Serial # _____

You can find them on the label on the front of the frame.



165D4700P330 49-55010 11-05 JR

IMPORTANT SAFETY INFORMATION. READ ALL INSTRUCTIONS BEFORE USING.

⚠ WARNING!

For your safety, the information in this manual must be followed to minimize the risk of fire or explosion, electric shock, or to prevent property damage, personal injury, or death.



SAFETY PRECAUTIONS

When using electrical appliances, basic safety precautions should be followed, including the following:

- This compactor is for household use only. Use this appliance only for its intended purpose as described in this Owner's Manual.
- Close supervision is necessary when any appliance is operated near children. Do not allow the compactor to be used as a toy, or to run unattended at any time.
- **CHILD LOCK-OUT INSTRUCTIONS:** Turn the knob to **OFF** and remove it when not compacting trash. This will help prevent anyone from tampering with the compactor or children from operating it.
- Do not push trash into the drawer with hands or feet. Trash might contain broken glass, sharp pieces of metal, or other sharp objects that might cause injury.
- When removing or carrying the trash bag, keep the bag away from your body. Sharp objects may have pierced it.
- Be careful when cleaning the inside of the cabinet or trash drawer. Glass fragments may be stuck to the ram, imbedded in the drawer surface or lying in the bottom of the cabinet.
- Do not install or store compactor where it will be exposed to outside conditions.
- Make sure the compactor is properly installed and leveled on a floor that can support its weight.
- Do not touch moving parts.
- Do not compact food waste such as raw meat and fish, rinds, personal hygiene items and disposable diapers. These items create very strong odors and should not go into the compactor.
- Do not use as a freestanding unit. Use only as a built-in unit.

PRECAUTIONS AGAINST UNREASONABLE USE OF YOUR COMPACTOR:

- Never compact shotgun shells, cartridges for firearms, fireworks, etc., which are highly explosive.
- Never compact flammable materials such as paint, oil- or gasoline-saturated rags, engine starting fluid cans, paint thinner cans, etc.—spontaneous combustion or explosive vapor concentrations could occur.
- Never compact containers of toxic chemicals such as strong insecticides or other poisonous materials—compaction could release hazardous fumes.
- Never compact aerosol cans containing explosive or highly toxic chemicals. (If you are sure the aerosol cans contain non-hazardous materials such as shaving cream, cheese spread and whipped cream, they may be compacted.)
- Do not compact lit cigarettes, cigars, or other hot or burning items.
- Do not store or use gasoline or other flammable vapors and liquids in the vicinity of this or any other appliance.
- Do not overload your appliance.
- Handle a loaded trash bag with care. Sharp objects can pierce the bag and cause injury. Do not overload trash bag with heavy material such as glass.

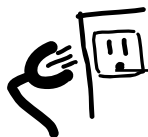

ELECTRICAL SAFETY

When using electrical appliances, basic safety precautions should be followed, including the following:

- To prevent hazard of electrical shock, this compactor must be properly installed and grounded in accordance with the Installation Instructions before it is used.
 - Do not operate with a damaged cord set, plug, motor, or after damage in any manner. Have the appliance examined, repaired, or adjusted by an authorized service technician.
 - Do not take apart this appliance. Incorrect reassembly can cause electric shock when subsequently used.
 - Unplug the compactor before making any repairs. **NOTE:** We strongly recommend that any servicing be performed by a qualified person.
 - Do not use an adapter plug or an extension cord with this appliance.
 - Follow National Electric Codes or prevailing local codes and ordinances. This appliance must be supplied with 120V, 60Hz and connected to an individual, properly grounded branch circuit protected by a 15 or 20 amp circuit breaker or time delay fuse.
 - If the electric supply provided does not meet the above requirements, call a licensed electrician.
 - We recommend that a separate circuit serving only this appliance be provided.
 - Do not, under any circumstances, cut or remove the third grounding prong from the power cord.
 - This appliance must be grounded. In the event of a malfunction or breakdown, grounding will reduce the risk of electric shock by providing a path of least resistance for electric current.
 - This appliance is equipped with a cord having an equipment grounding conductor and a grounding plug. The plug must be plugged into an appropriate outlet that is properly installed and grounded in accordance with local codes and ordinances.
- ⚠ WARNING:** Improper connection of the equipment grounding conductor can result in a risk of electric shock. Check with a qualified electrician if you are in doubt as to whether the appliance is properly grounded.
- Do not modify the plug with this appliance. If it will not fit the outlet installed, have a proper outlet installed by a qualified electrician.



PROPER INSTALLATION AND MAINTENANCE

This compactor must be properly installed and located in accordance with the Installation Instructions before it is used. If you did not receive an Installation Instructions sheet, you can receive one by visiting ge.com, or by calling 800.GE.CARES (800.432.2737) in the United States. In Canada, visit www.geappliances.ca or call 1.800.361.3400.



READ AND FOLLOW THIS SAFETY INFORMATION CAREFULLY.

SAVE THESE INSTRUCTIONS

About the trash compactor.

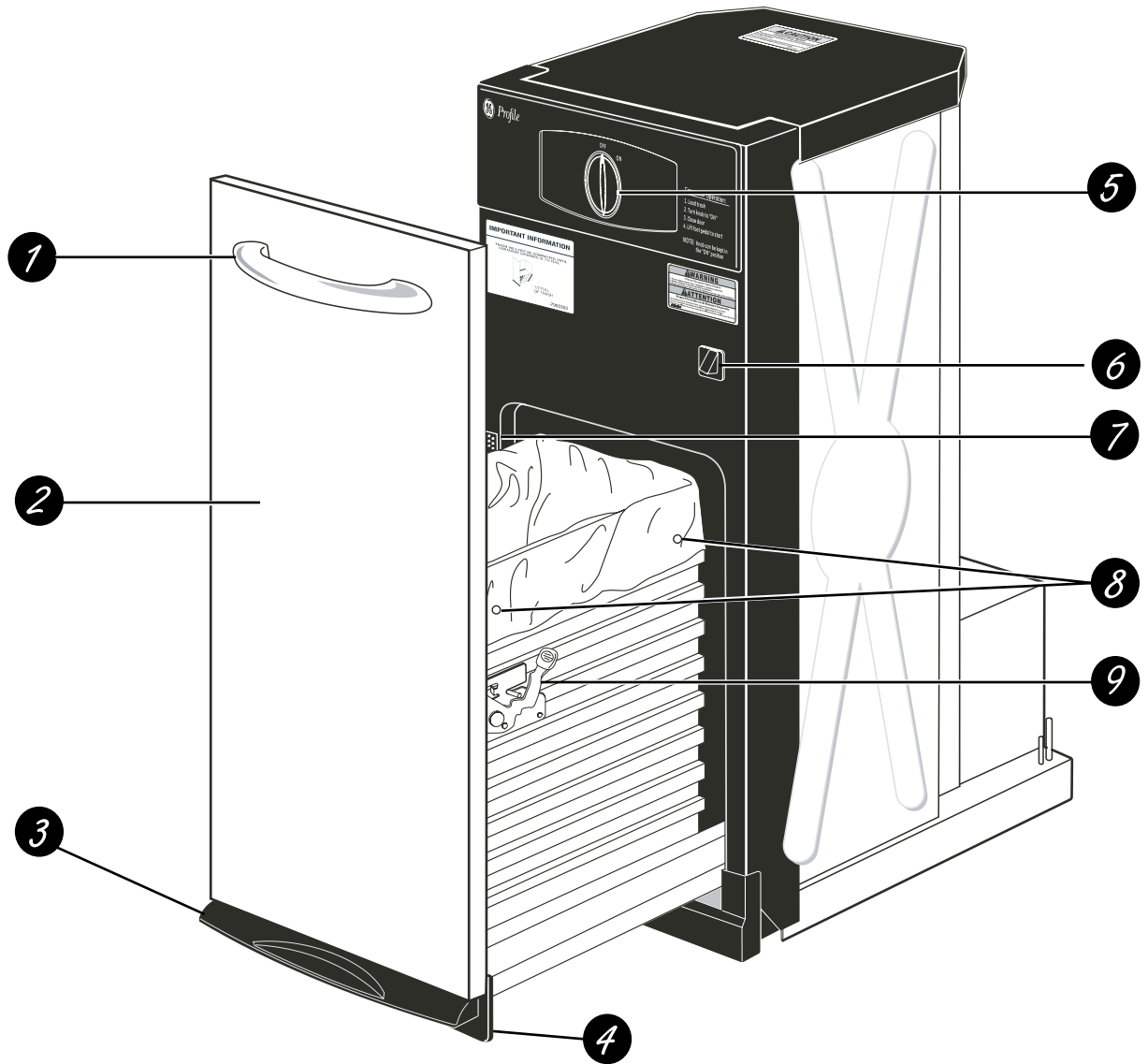

Features

- | | |
|--|--|
| 1 DRAWER HANDLE | 6 DRAWER SAFETY SWITCH |
| 2 DOOR PANEL | 7 MODEL AND SERIAL NUMBER LABEL |
| 3 FOOT PEDAL DRAWER OPENER AND COMPACTOR ACTIVATION | 8 BAG RETAINER BUTTONS |
| 4 TOE KICK | 9 MOVEABLE SIDE DOOR LATCH |
| 5 ON/OFF KNOB | |

What It Does and How It Works

Your compactor reduces household trash to as little as one-fourth of its original volume.

It compacts most refuse, including paper, cans, bottles, jars, plastic containers, wrappings, sweepings and some food wastes.

Drop trash into the disposable bag (designed for compactor use) that lines the compactor trash drawer and close the drawer. When you start the compactor, an electrically-operated ram moves down into the drawer, compacts trash, moves back up again—and the compactor shuts off automatically.

NOTE: The trash drawer must be at least 1/2 full before you will notice compaction because the ram does not travel all the way down into the drawer. By adding trash, compaction is transferred to the items below until all trash is compacted.

ON/OFF Knob

The removable knob is provided for your protection as a safety measure. When the knob switch is in the **OFF** position, the compactor will not operate.

Child Lockout Instructions:

Lock the compactor when it is not in use, by removing the knob. This will keep children from operating the compactor and prevent anyone from tampering with it.

Drawer Safety Switch

The compactor has two safety switches to ensure that the drawer is in its fully closed position for operation. The compactor will not cycle without the drawer being fully closed.

Trash Bag Installation

Before installing a new bag, be sure that:

- 1 The drawer side is securely locked.
- 2 The container is clean and free of sharp debris that may puncture the bag.

Reinforced plastic bags came with your compactor and are ready to be installed.

You must use the specially designed heavy-duty trash bags included with your compactor. These bags are available from your dealer or Factory Service Center. Ask for catalog number WC60X5017. If you prefer, you can order by mail. A handy order form is provided with your compactor and is included in every replacement bag package.

To install a new bag:

- 1 Place the bag into the drawer. Open the bag and pull the top edges over the drawer top.
- 2 Lock the bag in place by pulling the four prepunched holes over the bag retainer buttons. Holes will expand over the buttons without harming the bag.

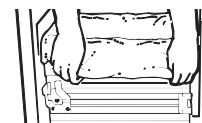

- 3 Press inside of bag against the drawer bottom, sides and corners for a smooth fit.

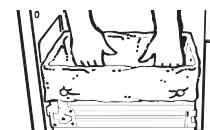

Loading

Slightly lift and pull the compactor door handle or press the foot pedal and pull the drawer out.

Remember:

- To help keep the ram clean when compacting messy food waste, place a couple of folded sheets of newspaper on top of the load to be compacted.
- Items too bulky to go into the drawer can be folded to fit. If it cannot be folded to fit into the drawer, do not attempt to force it in.

■ Folded newspaper is also helpful when compacting a large glass bottle, or several bottles or jars, or any other items that might shatter.

■ Although it is not necessary to compact until the drawer is full or nearly full, we suggest that, for maximum compaction, you start the compactor each time a significant amount of trash is added.



Using the trash compactor.

Compacting

To start the compactor:

- 1 Turn the knob to **ON**.
- 2 Make sure the drawer is fully closed.
- 3 Lift the foot pedal up to start cycle.

The ram travels downward into the drawer, compacting the trash. At the bottom of the stroke, the ram automatically reverses direction, retracts out of the drawer, returns to its starting position, and the compactor shuts off automatically.

The cycle takes less than 30 seconds. As the trash drawer fills with trash, cycle time gets progressively shorter.

NOTES:

- **You will not see compacting of trash the first few times you load.** The compactor drawer should be about 1/2 full before the compactor can begin to compress the load.
- **Glass bottles can make a loud noise when they break during compaction.** This is normal. Also, bottles in the trash drawer will not always break during the first cycle. Breaking glass and associated noise may occur several cycles later, depending on the type and volume of the trash.
- **When bottles and cans are compacted, small tears in the bag may occur.** This

is normal and in no way affects the performance of the compactor. Keep the bag away from your body to prevent injury from sharp objects that may have pierced the bag.

CAUTION:

- **Do not apply too much force when turning the knob.** The knob should always rotate easily. Forcing may break the knob and damage the switch.
- **When emptying waste baskets into the trash drawer, some items may spill into the compactor behind the drawer.** Items behind the drawer could prevent it from closing completely and prevent the compactor from operating. To remove such items from behind the drawer, open the drawer and remove it to clean them out. See the *Care and Cleaning* section.

To stop the compactor:

The compactor may be stopped at any time.

- 1 Attempting to open the drawer while the ram is moving will stop the ram. The safety switch will activate.
- 2 Close the drawer completely and the ram will travel back to the UP position.
- 3 Open the drawer fully and turn the knob to **OFF**.

Removing a Full Trash Bag

- 1 Pull the drawer completely open.
- 2 Remove the top of the bag from the bag retainer buttons. Pull up all four bag cuffs.

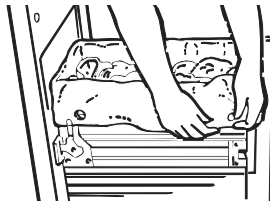

- 4 Lift the bag out.



- 3 Push the side-lock latch down and tilt the drawer side open.

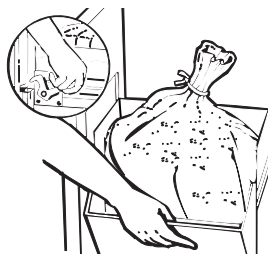

As is true of most appliances, proper care is needed to give you continued satisfaction. Before cleaning the compactor, turn the knob to the **OFF** position and remove it. If you will be away for more than a couple of days, remove the compactor bag. Lock the compactor by removing the knob and store it in a safe place.

Cleaning the Unit

To clean the outside:

Wipe with a clean damp cloth.

Painted panels:

Apply a coat of kitchen/appliance wax when the compactor is new, and then several times a year.

Stainless steel panels:

Stainless steel panels can be cleaned with Cerama Bryte® or a similar product using a clean, soft cloth.

Cerama Bryte is available from GE Parts by calling **800.626.2002** (U.S.) or **800.661.1616** (Canada).

To clean the drawer interior:

- 1 Remove the bag. See page 6.
- 2 Wear protective gloves. There may be bits of glass in the drawer. Press the side door latch down.

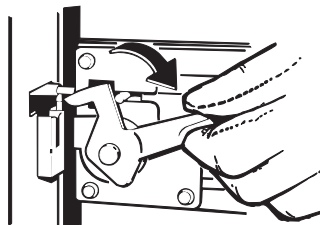

- 3 Hold the side door latch and tilt the side of the drawer until the latch clears the drawer front. The drawer side can be removed by tilting and sliding it out.

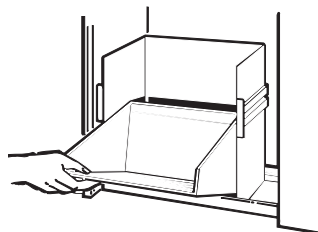

- 4 Wash with a damp cloth using warm, soapy water. Rinse and then dry with a soft cloth.
- 5 If the drawer side was removed, slide it back into the tilted position.
- 6 Press the side door latch down while pressing the side to the upright position. Lock the side door latch.

To clean the cabinet interior:

- 1 Pull the drawer out until it stops. Note the tracks in which the drawer rollers move.
- 2 Lift the front to clear the drawer stops. Grab the drawer on both sides. Pull it out the rest of the way and set it aside.

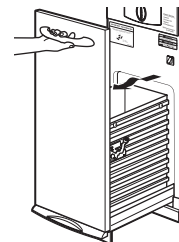

- 3 Vacuum inside of the cabinet. Liquid spills or wet trash should be cleaned up by hand, or use a vacuum designed to pick up liquid.

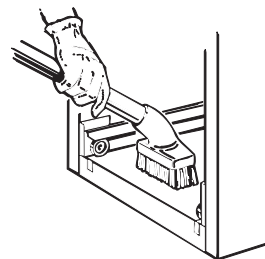

- 4 Wash, rinse and dry the inside.

Before you call for service...



Troubleshooting Tips

Problem	Possible Causes	What To Do
Compactor won't operate	Compactor is unplugged	<ul style="list-style-type: none"> • Make sure the cord is plugged securely into a working outlet.
	Circuit breaker/fuse is tripped/blown	<ul style="list-style-type: none"> • Check house circuit breakers /fuses. Replace fuses or reset breaker.
	Knob switch may not be in the ON position	<ul style="list-style-type: none"> • Make sure the switch is in the ON position. • Foot pedal may not have been lifted up long enough to start the compaction cycle.
	Drawer may not be closed	<ul style="list-style-type: none"> • Check to make sure the drawer is firmly closed.
	Compactor has an automatic thermal motor reset	<ul style="list-style-type: none"> • If you have just compacted repeatedly, this protector may have opened the motor circuit. Wait a few minutes and the motor reset will reclose automatically.
Drawer is hard to close	Trash may have fallen behind the drawer	<ul style="list-style-type: none"> • Remove any trash.
Drawer will not open	The ram is not all the way up	<ul style="list-style-type: none"> • Lift up on the foot pedal and release to allow ram to complete a cycle.
Little or no apparent compaction	Drawer is not full enough	<ul style="list-style-type: none"> • The drawer must be at least 1/2 full of trash before you will see any amount of compacting. The ram does not travel all the way to the bottom. Trash in the bottom of the drawer will be crushed during later cycles.
	Trash is stuck between ram and basket	<ul style="list-style-type: none"> • Remove any trash.

FOR CONSUMERS IN THE UNITED STATES

GE Service Protection Plus™

GE, a name recognized worldwide for quality and dependability, offers you Service Protection Plus™—comprehensive protection on all your appliances—**No Matter What Brand!**

Benefits Include:

- Backed by GE
- All brands covered
- Unlimited service calls
- All parts and labor costs included
- No out-of-pocket expenses
- No hidden deductibles
- One 800 number to call

***We'll Cover Any Appliance.
Anywhere. Anytime.****

You will be completely satisfied with our service protection or you may request your money back on the remaining value of your contract. No questions asked. It's that simple.

Protect your refrigerator, dishwasher, washer and dryer, range, TV, VCR and much more—**any brand!** Plus there's no extra charge for emergency service and low monthly financing is available. Even icemaker coverage and food spoilage protection is offered. You can rest easy, knowing that all your valuable household products are protected against expensive repairs.

Place your confidence in GE and call us in the U.S. toll-free at **800.626.2224** for more information.

*All brands covered, up to 20 years old, in the continental U.S.



Please place in envelope and mail to:

General Electric Company
Warranty Registration Department
P.O. Box 32150
Louisville, KY 40232-2150

FOR CONSUMERS IN THE UNITED STATES

Consumer Product Ownership Registration

Dear Customer:

Thank you for purchasing our product and thank you for placing your confidence in us. We are proud to have you as a customer!

Follow these three steps to protect your new appliance investment:

1

Complete and mail your Consumer Product Ownership Registration today. Have the peace of mind of knowing we can contact you in the unlikely event of a safety modification.

2

After mailing the registration below, store this document in a safe place. It contains information you will need should you require service. Our service number is 800.GE.CARES (800.432.2737).

3

Read your Owner's Manual carefully. It will help you operate your new appliance properly.

Model Number

Serial Number

Important: If you did not get a registration card with your product, detach and return the form below to ensure that your product is registered, or register online at ge.com.

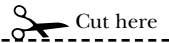

Consumer Product Ownership Registration



Model Number

Serial Number

Mr. Ms. Mrs. Miss

First Name

Last Name

Street Address

Apt. #

E-mail Address*

City

State

Zip Code

Date Placed In Use
Month

Day

Year

Phone Number

* Please provide your e-mail address to receive, via e-mail, discounts, special offers and other important communications from GE Appliances (GEA).

Check here if you do not want to receive communications from GEA's carefully selected partners.
FAILURE TO COMPLETE AND RETURN THIS CARD DOES NOT DIMINISH YOUR WARRANTY RIGHTS.

For more information about GEA's privacy and data usage policy, go to ge.com and click on "Privacy Policy" or call 800.626.2224.



GE Consumer & Industrial Appliances
General Electric Company
Louisville, KY 40225
ge.com

Please place in envelope and mail to:
Veuillez mettre dans une enveloppe et envoyez à :

**OWNERSHIP REGISTRATION
P.O. BOX 1780
MISSISSAUGA, ONTARIO
L4Y 4G1**

(FOR CANADIAN CONSUMERS ONLY)



For Canadian
Customers



Pour les
Consommateurs
Canadiens

CUT ALONG THIS LINE AND RETURN CARD—THANKS

OWNERSHIP REGISTRATION CERTIFICATE – FICHE D'INSCRIPTION DU PROPRIÉTAIRE

Please register your product to enable us to contact you in the remote event a safety notice is issued for this product and to allow for efficient communication under the terms of your warranty, should the need arise.

Veillez enregistrer votre produit afin de nous permettre de communiquer avec vous si jamais un avis de sécurité concernant ce produit était émis et de communiquer facilement avec vous en vertu de votre garantie, si le besoin s'en fait sentir.

REGISTER ON-LINE: www.geappliances.ca		MAIL TO: P.O. BOX 1780, MISSISSAUGA ONTARIO, L4Y 4G1	
ENREGISTREMENT SUR INTERNET À: www.electromenagersqe.ca		POSTER À:	
<input type="checkbox"/> MR./M	<input type="checkbox"/> MRS./MME.	FIRST NAME / PRÉNOM	LAST NAME / NOM
<input type="checkbox"/> MISS/MLLE.	<input type="checkbox"/> MS.		
STREET NO / N° RUE	STREET NAME / RUE	APT. NO / APP. / RR#	
CITY / VILLE		PROVINCE	POSTAL CODE / POSTAL
AREA CODE / IND. RÉG.	TELEPHONE	E-MAIL	
DID YOU PURCHASE A SERVICE CONTRACT FOR THIS APPLIANCE? AVEZ-VOUS ACHETÉ UN CONTRAT DE SERVICE POUR CET APPAREIL ?		YES / OUI <input type="checkbox"/>	IF YES / SI OUI: EXPIRATION
		NO / NON <input type="checkbox"/>	Y/A M D/J
NAME OF SELLING DEALER / NOM DU MARCHAND		MODEL / MODÈLE	
INSTALLATION DATE / DATE D'INSTALLATION Y/A M D/J	CORRESPONDENCE <input type="checkbox"/> ENGLISH CORRESPONDANCE <input type="checkbox"/> FRANÇAIS	SERIAL / SÉRIE	
<input type="checkbox"/> I do not wish to receive any promotional offers regarding this product. <input type="checkbox"/> Je ne désire pas recevoir d'offres promotionnelles concernant ce produit.			

Notes.

Safety Instructions

Operating Instructions

Care and Cleaning

Troubleshooting Tips

Consumer Support

<i>Consumer Support</i>
<i>Troubleshooting Tips</i>
<i>Care and Cleaning</i>
<i>Operating Instructions</i>
<i>Safety Instructions</i>

Notes.

Trash Compactor Warranty.



All warranty service provided by our Factory Service Centers, or an authorized Customer Care® technician. To schedule service, on-line, 24 hours a day, visit us at ge.com, or call 800.GE.CARES (800.432.2737) in the United States. In Canada, call 1.800.361.3400. Please have serial number and model number available when calling for service.

Staple your receipt here.
Proof of the original purchase date is needed to obtain service under the warranty.

For The Period Of: **GE Will Replace:**

One Year

From the date of the original purchase

Any part of the compactor which fails due to a defect in materials or workmanship.

During this **limited one-year warranty**, GE will also provide, **free of charge**, all labor and in-home service to replace the defective part.

What GE Will Not Cover:

- Service trips to your home to teach you how to use the product.
- Improper installation, delivery or maintenance.
- Failure of the product if it is abused, misused, or used for other than the intended purpose or used commercially.
- Replacement of house fuses or resetting of circuit breakers.
- Damage to the product caused by accident, fire, floods or acts of God.
- Incidental or consequential damage caused by possible defects with this appliance.
- Damage caused after delivery.
- Product not accessible to provide required service.

EXCLUSION OF IMPLIED WARRANTIES—Your sole and exclusive remedy is product repair as provided in this Limited Warranty. Any implied warranties, including the implied warranties of merchantability or fitness for a particular purpose, are limited to one year or the shortest period allowed by law.

This warranty is extended to the original purchaser and any succeeding owner for products purchased for home use within the USA. If the product is located in an area where service by a GE Authorized Servicer is not available, you may be responsible for a trip charge or you may be required to bring the product to an Authorized GE Service location for service. In Alaska, the warranty excludes the cost of shipping or service calls to your home.

Some states do not allow the exclusion or limitation of incidental or consequential damages. This warranty gives you specific legal rights, and you may also have other rights which vary from state to state. To know what your legal rights are, consult your local or state consumer affairs office or your state's Attorney General.

Warrantor: General Electric Company. Louisville, KY 40225

Consumer Support.



GE Appliances Website

In the U.S.: **ge.com**

Have a question or need assistance with your appliance? Try the GE Appliances Website 24 hours a day, any day of the year! For greater convenience and faster service, you can now download Owner's Manuals, order parts, catalogs, or even schedule service on-line. You can also "Ask Our Team of Experts™" your questions, and so much more... **In Canada: www.GEAppliances.ca**



Schedule Service

In the U.S.: **ge.com**

Expert GE repair service is only one step away from your door. Get on-line and schedule your service at your convenience 24 hours any day of the year! Or call 800.GE.CARES (800.432.2737) during normal business hours. **In Canada, call 1.800.361.3400.**



Real Life Design Studio

In the U.S.: **ge.com**

GE supports the Universal Design concept—products, services and environments that can be used by people of all ages, sizes and capabilities. We recognize the need to design for a wide range of physical and mental abilities and impairments. For details of GE's Universal Design applications, including kitchen design ideas for people with disabilities, check out our Website today. For the hearing impaired, please call 800.TDD.GEAC (800.833.4322).

In Canada, contact: Manager, Consumer Relations, Camco, Inc.
Suite 310, 1 Factory Lane
Moncton, N.B. E1C 9M3



Extended Warranties

In the U.S.: **ge.com**

Purchase a GE extended warranty and learn about special discounts that are available while your warranty is still in effect. You can purchase it on-line anytime, or call 800.626.2224 during normal business hours. GE Consumer Home Services will still be there after your warranty expires. **In Canada, call 1.800.661.1616.**

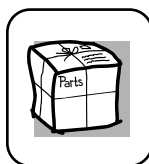

Parts and Accessories

In the U.S.: **ge.com**

Individuals qualified to service their own appliances can have parts or accessories sent directly to their homes (VISA, MasterCard and Discover cards are accepted). Order on-line today, 24 hours every day or by phone at 800.626.2002 during normal business hours.

Instructions contained in this manual cover procedures to be performed by any user. Other servicing generally should be referred to qualified service personnel. Caution must be exercised, since improper servicing may cause unsafe operation.

Customers **in Canada** should consult the yellow pages for the nearest Camco service center, or call 1.800.661.1616.



Contact Us

In the U.S.: **ge.com**

If you are not satisfied with the service you receive from GE, contact us on our Website with all the details including your phone number, or write to:

General Manager, Customer Relations
GE Appliances, Appliance Park
Louisville, KY 40225

In Canada: www.GEAppliances.ca, or write to: Director, Consumer Relations, Camco, Inc.

Suite 310, 1 Factory Lane
Moncton, N.B. E1C 9M3



Register Your Appliance

In the U.S.: **ge.com**

Register your new appliance on-line—at your convenience! Timely product registration will allow for enhanced communication and prompt service under the terms of your warranty, should the need arise. You may also mail in the pre-printed registration card included in the packing material. **In Canada: www.GEAppliances.ca**

Free Manuals Download Website

<http://myh66.com>

<http://usermanuals.us>

<http://www.somanuals.com>

<http://www.4manuals.cc>

<http://www.manual-lib.com>

<http://www.404manual.com>

<http://www.luxmanual.com>

<http://aubethermostatmanual.com>

Golf course search by state

<http://golfingnear.com>

Email search by domain

<http://emailbydomain.com>

Auto manuals search

<http://auto.somanuals.com>

TV manuals search

<http://tv.somanuals.com>