

VG4256



VCR User's Guide



We bring good things to life.

Important Information

WARNING

To reduce the risk of fire or shock hazard, do not expose this product to rain or moisture.

WARNING

RISK OF ELECTRIC SHOCK
DO NOT OPEN

TO REDUCE THE RISK OF ELECTRIC SHOCK, DO NOT REMOVE COVER (OR BACK). NO USER SERVICEABLE PARTS INSIDE. REFER SERVICING TO QUALIFIED SERVICE PERSONNEL.



This symbol indicates "dangerous voltage" inside the product that presents a risk of electric shock or personal injury.



This symbol indicates important instructions accompanying the product.

Cautions

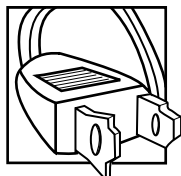

Caution: To prevent electric shock, match wide blade of plug to wide slot, fully insert.

Attention: Pour éviter les chocs électriques, introduire la lame la plus large de la fiche dans la borne correspondante de la prise et pousser jusqu'au fond.

Do not defeat the safety feature of the plug. The wide blade fits into the wall socket only one way. If you need an extension cord, make sure it matches the plug of the product.

Refer to the identification / rating label (normally located on the back of the product) for the proper operating voltage for this product.

FCC Regulations state that unauthorized changes or modifications to this equipment may void the user's authority to operate it.

Note To Cable TV Installer

This reminder is provided to call your attention to Article 820-40 of the National Electrical Code (Section 54 of the Canadian Electrical Code, Part 1) which provides guidelines for proper grounding and, in particular, specifies that the cable ground shall be connected to the grounding system of the

Product Registration

Please fill out the product registration card and return it immediately. Returning this card allows us to contact you if needed.

Keep your sales receipt to obtain warranty parts and service and for proof of purchase. Attach it here and record the serial and model numbers in case you need them. The numbers are located on the back of the product.

Model No. **VG4256** _____

Serial No. _____

Purchase Date: _____

Dealer / Address / Phone: _____

Table of Contents

Important Information

Warnings _____	i
Cautions _____	i
Note to Cable TV Installer _____	i
Product Registration _____	i

Hooking Up the VCR

Choosing a Hookup _____	2
Antenna or Cable System Without a Cable Box _____	3
Cable System With Cable Box to Unscramble All Channels _____	4
Cable System With Cable Box to Unscramble Only Pay Channels _____	5
Connecting Two VCRs for Copying Tapes _____	6
Connecting a Stereo Amplifier/Receiver _____	7

Setting Up the VCR

Startup	
Check Accessories With VCR _____	8
Insert Batteries in Remote _____	8
Turn on TV and VCR _____	8
Place Channels in VCR's Memory _____	9
Add or Remove Channels from VCR's Memory _____	9
Select the Language/Seleccione el Idioma/Sélectionner la Langue _____	10
Use TV•VCR Button _____	10
Set the Display Panel Feature _____	10
Set the ALERT SOUND Feature _____	11
Set the Time and Date _____	11
Set the Automatic Daylight- Saving Time _____	12

Using the Remote Control

VCR Function Buttons _____	13
----------------------------	----

Playing a Tape

Playback _____	14
Using the Playback Features	
Auto Play Feature _____	15
Picture Search _____	15
Slow Motion _____	15
DISPLAY Button _____	16

Time Counter _____	16
Index Search _____	17
Zero Search _____	17
Commercial Scan (SEARCH Button) _____	17
Pause for Stop-Action _____	18
Frame Advance (F.ADV Button) _____	18
Automatic Tracking _____	18
Manual Tracking _____	18
TAPE PLAYBACK: HI-FI/LINEAR Feature _____	19

Recording a Program

Recordings _____	20
Recording Speeds _____	20
Normal Recording _____	20
Watch a TV Channel While VCR is Recording a Different Channel _____	20
One Touch Recording _____	21
Recording While You're Away	
Setting a Timer Recording _____	22
Stopping a Timer Recording _____	22
Timer Recording From the VCR's Line Input _____	23
Checking or Clearing Timer Recordings _____	23
Stereo Broadcast TV or SAP _____	24
Recording Audio Only _____	25
Using the Recording Features	
Recording Pause _____	25
Pro-Tect Plus™ Feature _____	25
Using Two VCRs for Copying and Editing Tapes _____	26
Copying and Editing Tapes Using Compatible Remote _____	26

References

Location of Controls	
Front Panel _____	27
Back Panel _____	28
Display Panel _____	28
Specifications _____	29
Cleaning the VCR _____	29
Trouble Checks _____	30-31
Limited Warranty _____	32
Index _____	33

Choosing a Hookup

The hookups on pages 3 through 5 are divided into two hookup types: Basic (A) and Advanced (B).

The basic hookup shows the backs of TVs that have only an antenna/cable connection. It is the easier of the two and additional accessories may not be needed.

The advanced hookup shows the VCR hooked up to a TV with audio and video jacks using a signal splitter. This connection may improve the picture quality as well as convenience of operation.

Answer the questions to choose the hookup for your VCR.

1. How does your TV receive signals?

Choose one answer from below.

- A. Outside antenna – Turn to page 3.
- B. Rabbit ears (set-top) and/or bow tie antenna – Turn to page 3.
- C. Cable System – Go to question 2.

2. What type of Cable-TV system* do you have?

Choose one answer from below.

- A. Cable without a box – Turn to page 3.
- B. Cable box to unscramble all the channels – Turn to page 4.
- C. Cable box to unscramble only pay channels, such as HBO, Showtime, Cinemax, etc. – Turn to page 5.

*You may need to contact your local cable company for assistance.

Optional Hookups

How to hook up two VCRs for copying tapes.

- A. Select a hookup by answering questions 1 and 2 above.
- B. Then, modify the connections as shown on page 6.

How to hook up a stereo amplifier/receiver.

- A. Select a hookup by answering questions 1 and 2 above.
- B. Then, modify the connections as shown on page 7.

Antenna or Cable System Without a Cable Box

A. Basic hookup.

Use this hookup for a simple connection which requires fewer accessories.

1. Set the **3CH.4** switch on back of VCR to either channel 3 or 4.
Tune the TV to this channel and use the TV•VCR button to watch the VCR.
2. **Connect as shown.**
This connection may require additional accessories not provided.
3. **Plug in power cords of VCR and TV.**
4. **Continue to page 8.**

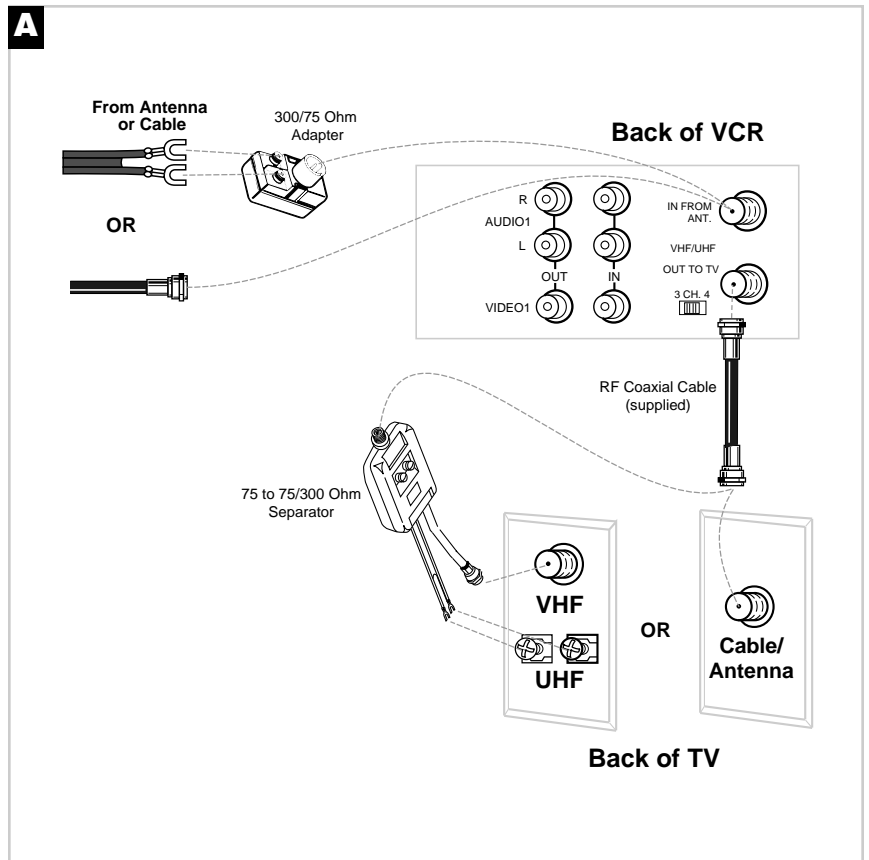

B. Advanced hookup.

Use this hookup for slightly improved picture quality, Hi-Fi, stereo playback and more convenient operation — use of the TV•VCR button is not required.

1. **Connect as shown.**
This connection requires additional accessories not provided. A Y-adaptor may be required to hear sound from both channels if your TV is not stereo.
2. **Plug in power cords of VCR and TV.**
3. **Continue to page 8.**
Tune the TV to its video input to watch the VCR.

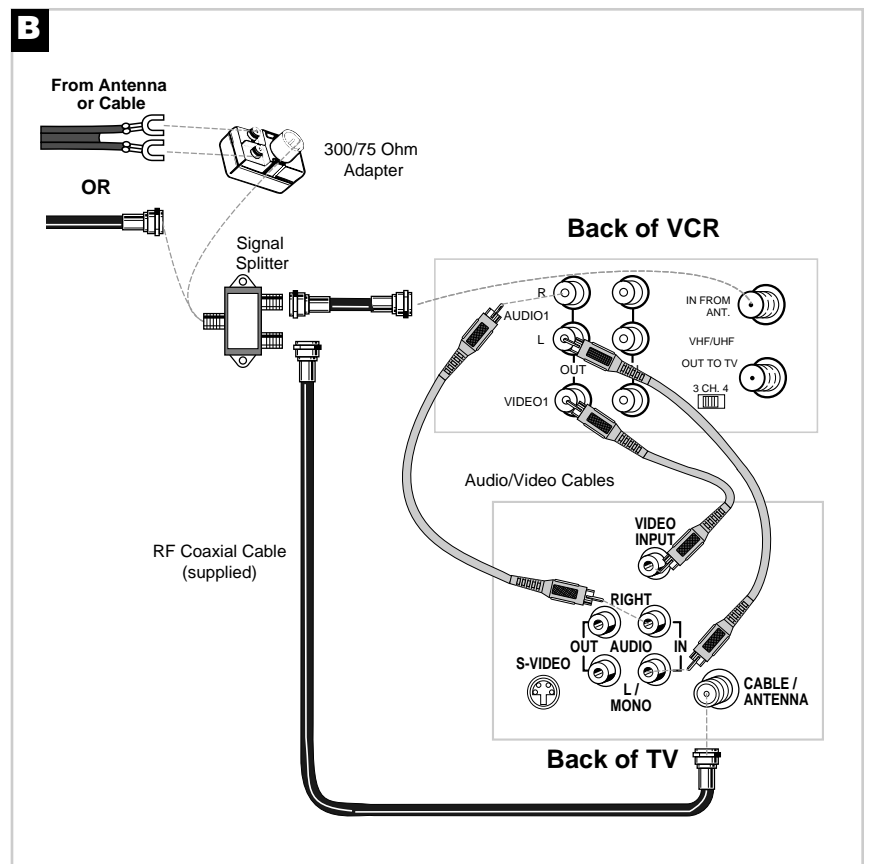

Cable System With Cable Box to Unscramble All Channels

A. Basic hookup.

Use this hookup for a simple connection which requires fewer accessories.

1. Set the **3CH.4** switch on back of VCR to either channel 3 or 4.
Tune the TV to this channel and use the TV•VCR button to watch the VCR.
2. **Connect as shown.**
This connection may require additional accessories not provided.
3. **Plug in power cords of VCR, TV, and cable box.**
4. **Continue to page 8.**

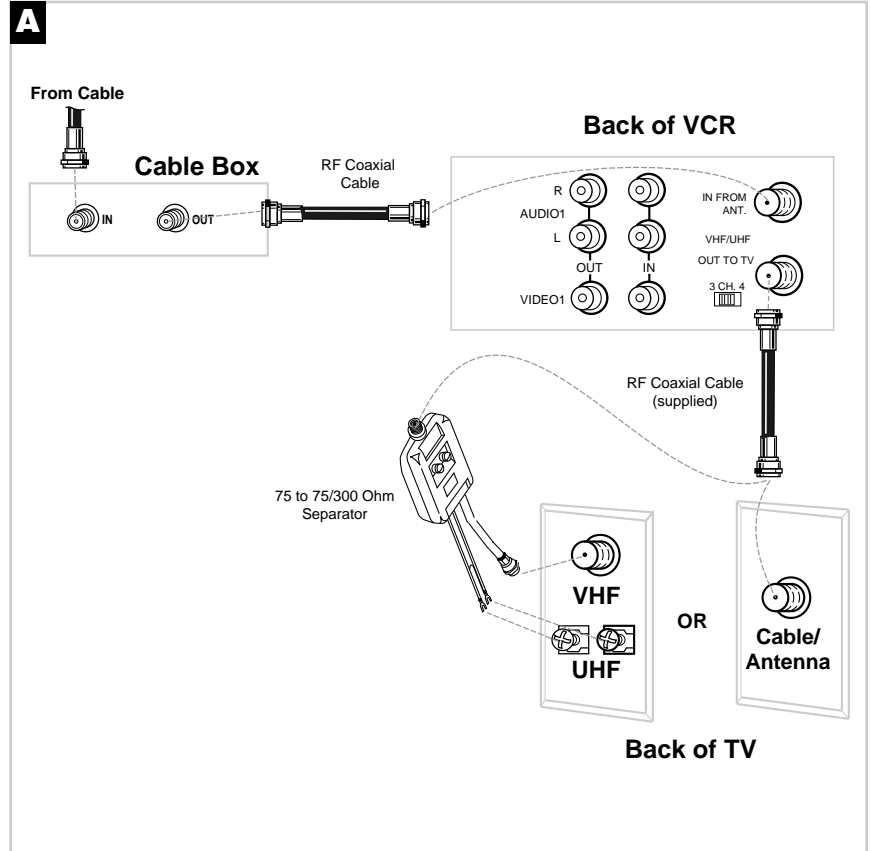

B. Advanced hookup.

Use this hookup for slightly improved picture quality, Hi-Fi, stereo playback and more convenient operation — use of the TV•VCR button is not required.

1. **Connect as shown.**
This connection requires additional accessories not provided. A Y-adaptor may be required to hear sound from both channels if your TV is not stereo.
2. **Plug in power cords of VCR, TV, and cable box.**
3. **Continue to page 8.**
Tune the TV to its video input to watch the VCR.

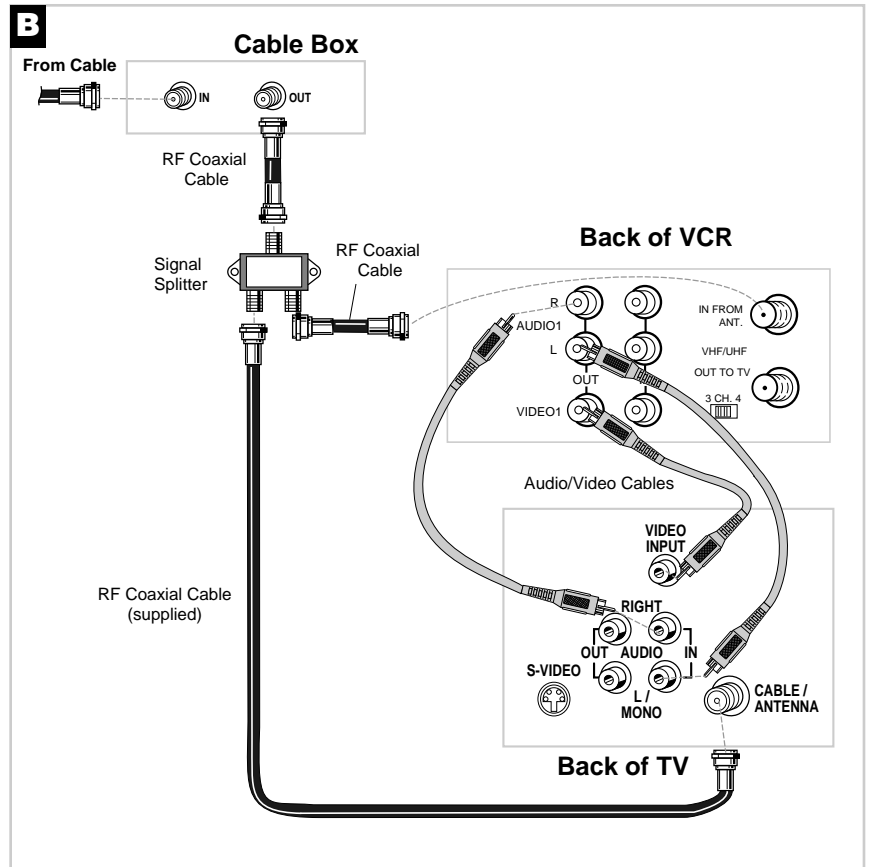

Cable System With Cable Box to Unscramble Only Pay Channels

(such as HBO, Showtime, Pay-Per-View, etc.)

A. Basic hookup.

Use this hookup for a simple connection which requires fewer accessories.

1. Set the **3CH.4** switch on back of VCR to either channel 3 or 4.
Tune the TV to this channel and use the TV•VCR button to watch the VCR.
2. **Connect as shown.**
This connection may require additional accessories not provided.
3. **Plug in power cords of VCR, TV, and cable box.**
4. **Continue to page 8.**

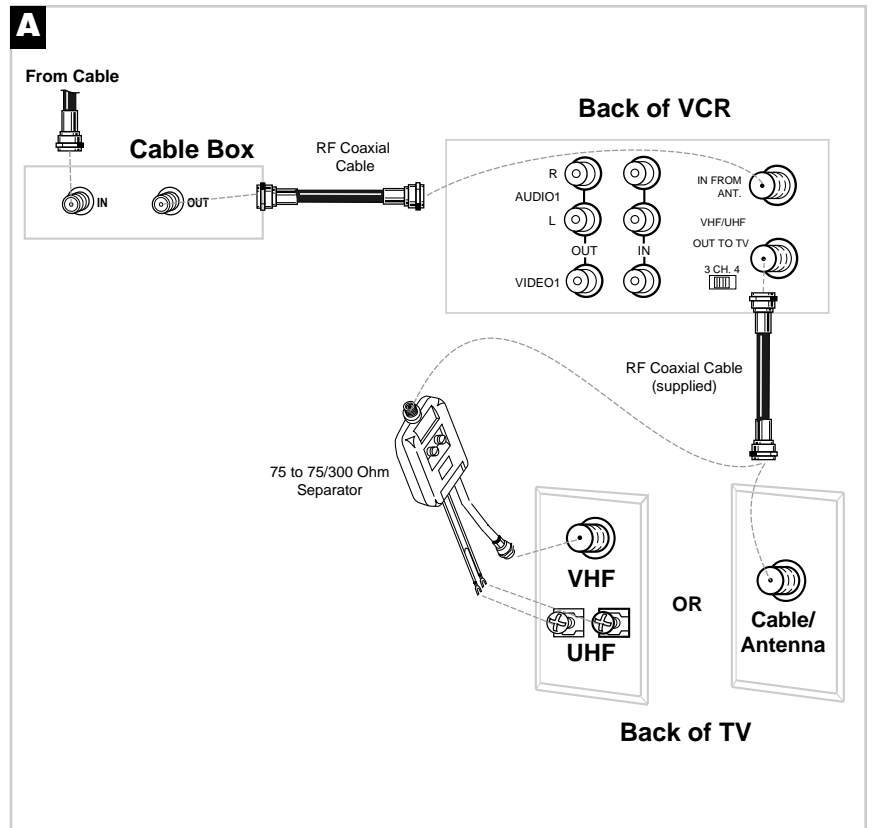

B. Advanced hookup.

Use this hookup for slightly improved picture quality, Hi-Fi, stereo playback and more convenient operation — use of the TV•VCR button is not required.

1. **Connect as shown.**
This connection requires additional accessories not provided. A Y-adaptor may be required to hear sound from both channels if your TV is not stereo.
2. **Plug in power cords of VCR, TV, and cable box.**
3. **Continue to page 8.**
Tune the TV to its video input to watch the VCR. View all pay channels through the VCR.

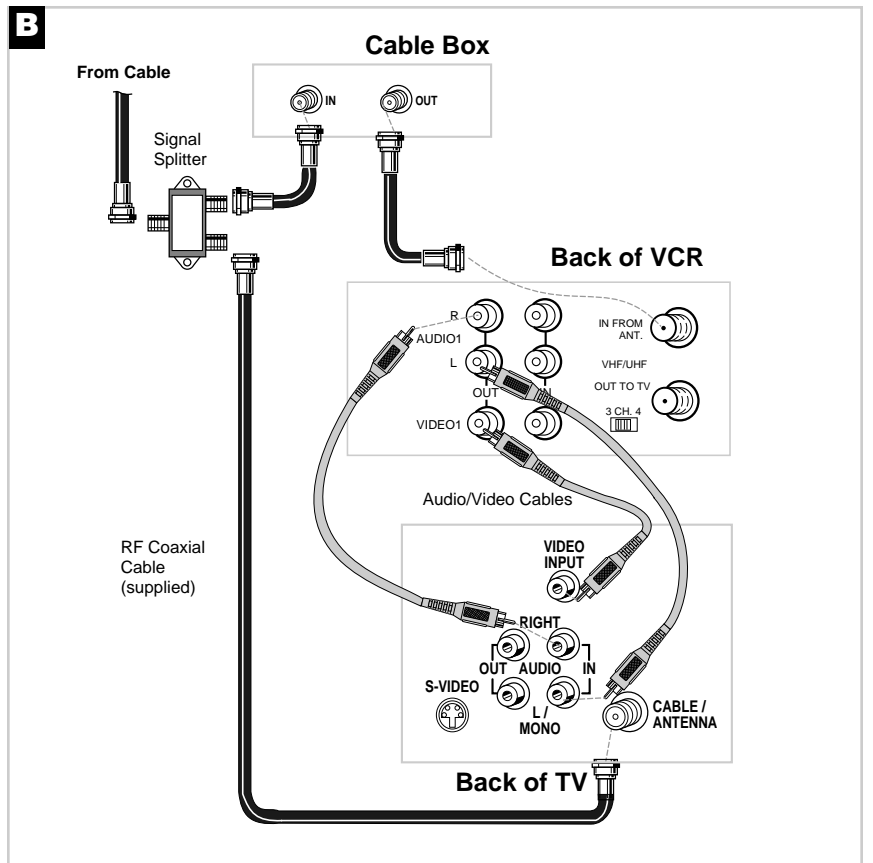

Connecting Two VCRs for Copying Tapes

Option A hookup.

Use this hookup for a simple connection which requires fewer accessories.

1. Select a hookup from pages 2 through 5 and then modify with this connection.
2. Set the 3CH.4 switch on the playback VCR to either channel 3 or 4.
Tune the recording VCR to this channel to receive the signal from the playback VCR.
3. Connect as shown.
This connection may require additional accessories not provided.
4. Plug in power cords of VCRs and TV.
5. **Continue to page 8.**

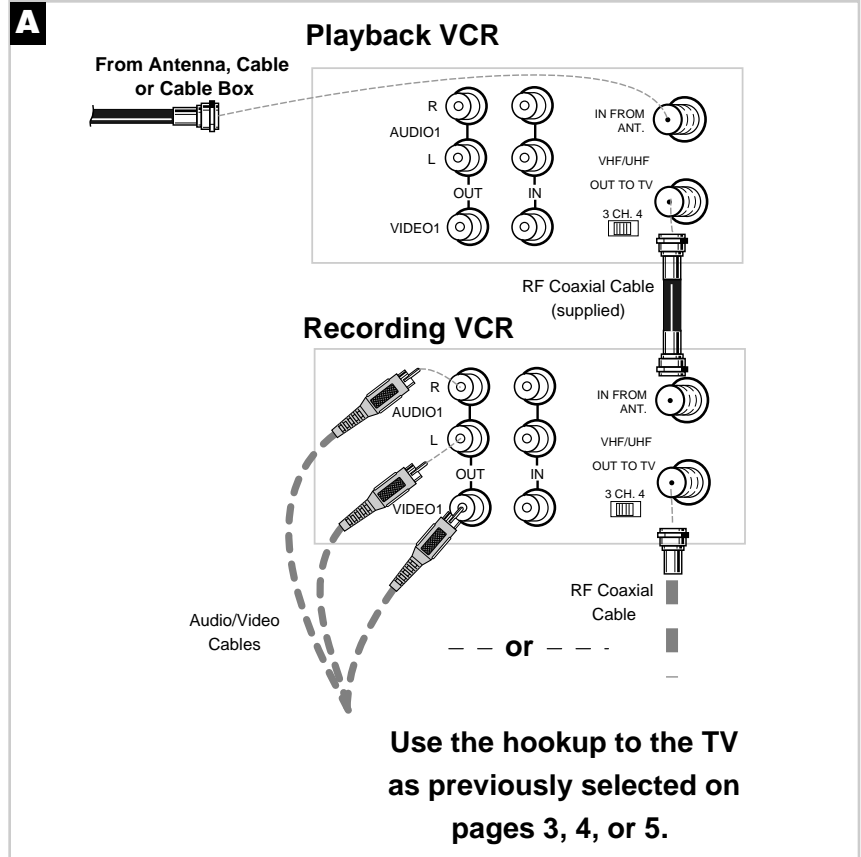

Option B hookup.

Use this hookup for slightly improved copy quality, Hi-Fi, stereo playback and more convenient operation — use of the TV•VCR button is not required.

1. Select a hookup from pages 2 through 5 and then modify with this connection.
2. Connect as shown.
This connection requires additional accessories not provided. A Y-adaptor may be required to hear sound from both channels if your other VCR is not stereo.
3. Plug in power cords of VCRs and TV.
4. **Continue to page 8.**
Select the line (audio/video) input on the recording VCR to receive the signal from the playback VCR.

Caution: The unauthorized recording of television programs and other materials may infringe the rights of others.

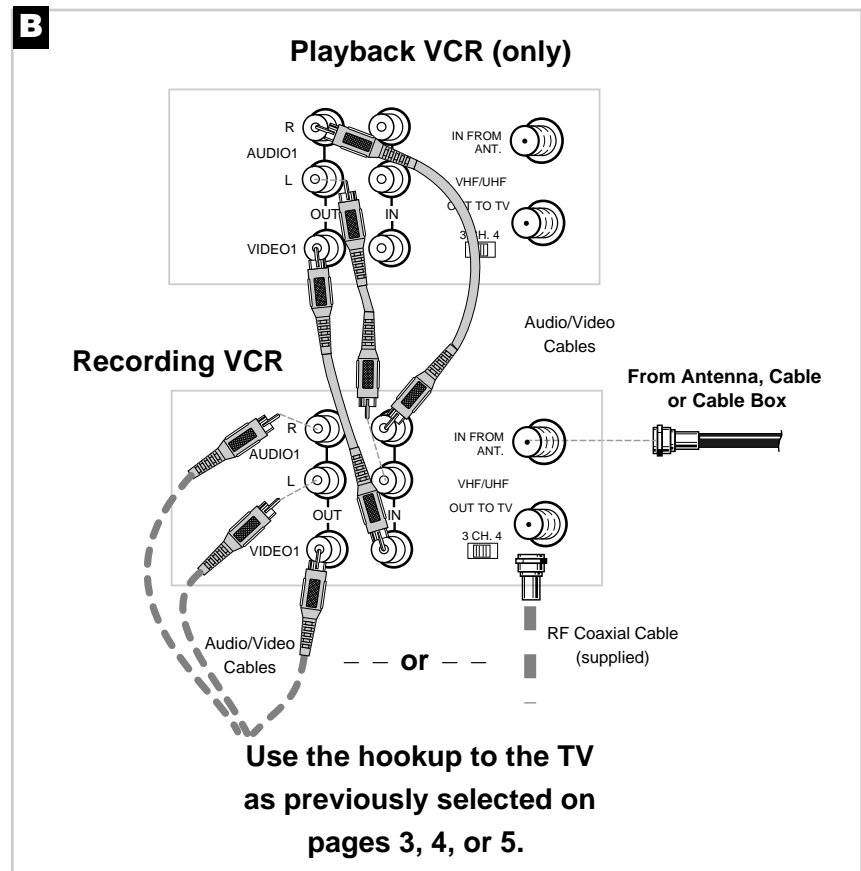

Connecting a Stereo Amplifier/Receiver

Record on the VCR from an amplifier/receiver.

Connect your VCR to a stereo amplifier/receiver to record stereo audio.

1. Select a hookup from pages 2 through 5 and then modify with this connection.
2. Connect as shown.
This connection requires additional accessories not provided.
3. Plug in power cords of amplifier/receiver, VCR, and TV.
4. See "Recording Audio" on page 25.
Select the line input on the VCR to receive the audio signal from the amplifier/receiver.

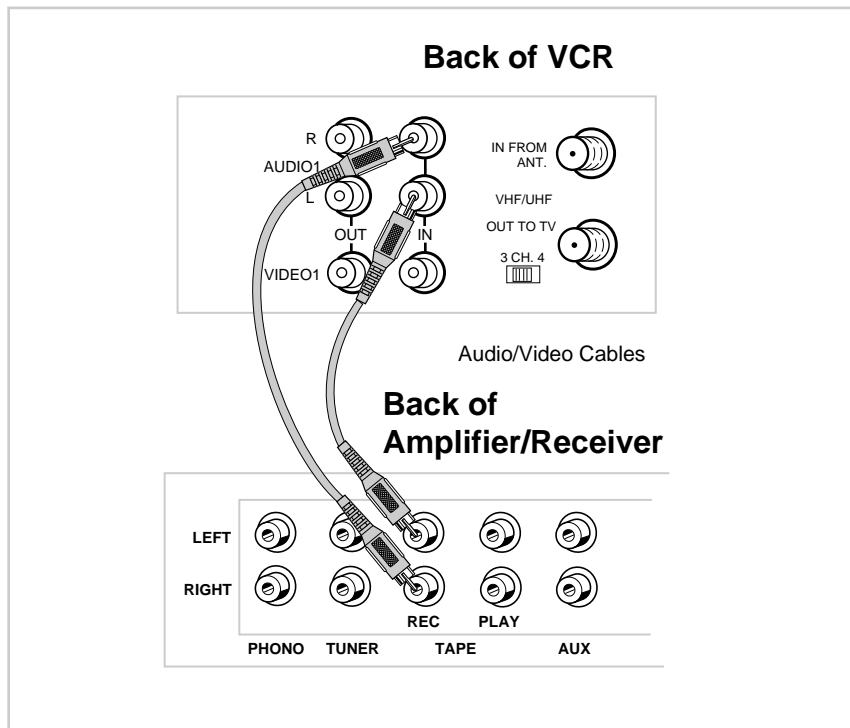

Play back stereo tapes or receive a stereo broadcast through an amplifier/receiver.

Connect your VCR to a stereo amplifier/receiver to receive stereo broadcasts or play back stereo tapes.

1. Select a hookup from pages 2 through 5 and then modify with this connection.
2. Connect as shown.
This connection requires additional accessories not provided.
3. Plug in power cords of amplifier/receiver, VCR, and TV.
4. See "Tape Playback" on page 19.

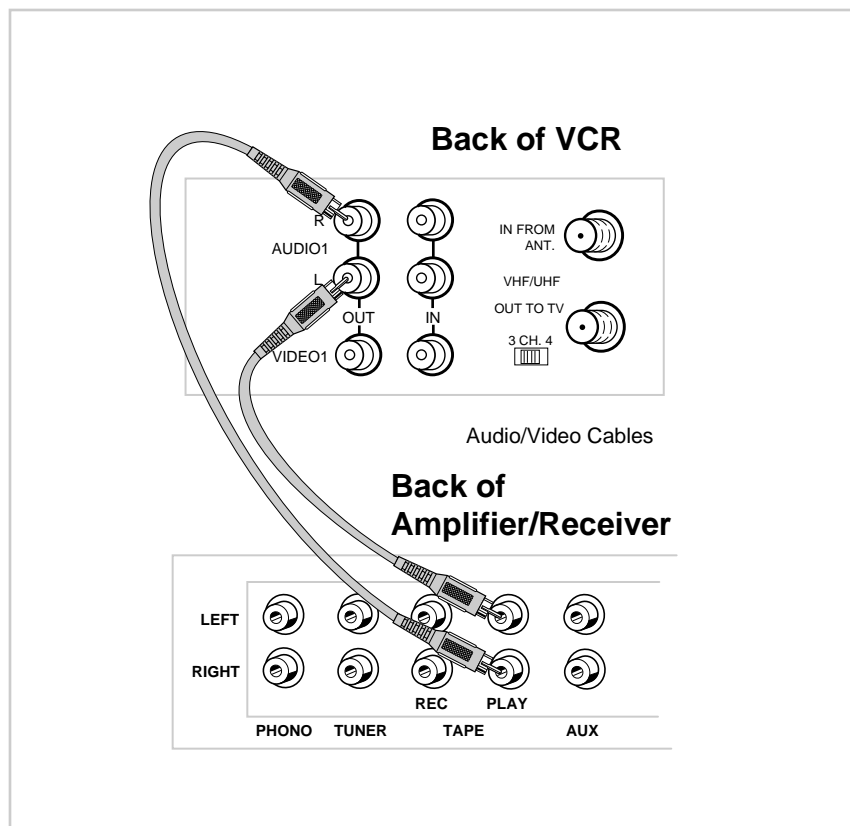

Startup

1. Check accessories with VCR.

Contact your dealer if any items are missing.

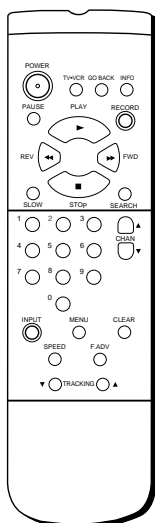

Remote
(Stock No. 221345)

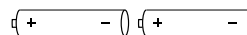

2 "AA" Batteries



RF Coaxial Cable
(Stock No. 221383)

2. Insert batteries in remote.

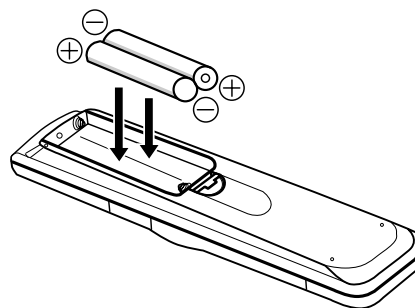
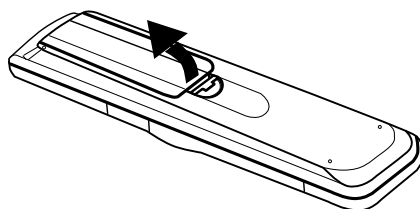

3. Turn on the TV.

If you used one of the basic hookups, tune the TV to the channel selected with the 3CH.4 switch on back of VCR.

If you used one of the advanced hookups, tune the TV to the TV's video input. (See TV owner's manual for details.)

4. Turn on the VCR.

Press POWER on the remote.

The POWER and VCR indicators light in the VCR's display panel.

Startup

5. Place channels in the VCR's memory.

The first time you turn on the VCR or after a power interruption, the VCR displays a message on the TV screen prompting you to perform the AUTO CHANNEL SEARCH. If the message does not appear, go to step A below. If the message appears, follow the directions on the screen.

Wait until the channel numbers stop changing. This takes about one to two minutes. The TV tunes to the lowest channel found. Pressing CHANNEL up or down selects only the active channels.

If you ever need to manually set up channels because you change cable or antenna signals:

- A. Press MENU to display the VCR MAIN MENU on the TV screen. If this menu does not appear:
 - Make sure the TV is tuned to same channel as the 3CH.4 switch on the VCR or the TV's video input (refer to TV's manual).
 - If you use a basic hookup, check the VCR indicator in display panel — it should be on. Press TV•VCR to turn it on.
 - Check the connections.
- B. Press 3 to display the CHANNELS menu.
- C. Press 1 to begin AUTO CHANNEL SEARCH.
The VCR automatically selects the CABLE (cable TV) or ANTENNA signal.

To change the SIGNAL TYPE:

- A. Follow steps A-B above.
- B. Press 3 to switch the SIGNAL TYPE between CABLE and ANTENNA.

6. Add or remove channels from the VCR's memory.

You may want to add or remove channels if some of the channels are not active, have weak signals, or you do not want to watch them.

- A. Press MENU on the remote to display the VCR MAIN MENU.
- B. Press 3 to display the CHANNELS menu.
- C. Press 2 to display the ADD/REMOVE CHANNEL display.
- D. Follow the directions on the screen.
- E. Add or remove more channels using the CHANNEL up and down buttons.

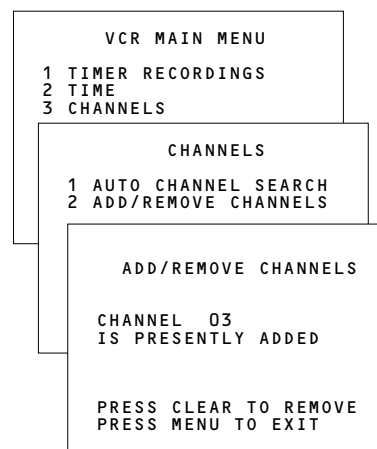
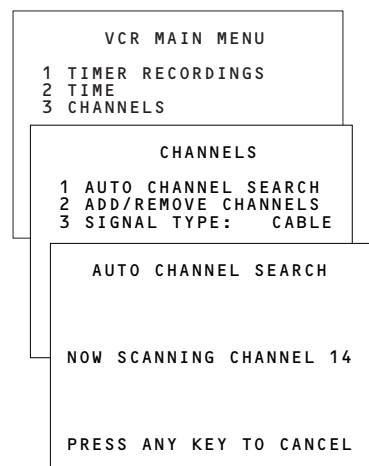
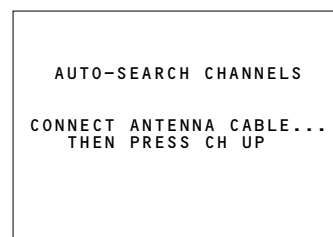

Startup

7. Select the language/Seleccione el idioma/ Sélectionner la langue.

The VCR displays the on-screen menus in the English, Spanish or French language. The word "Language" cycles through the different languages when the VCR Main Menu is displayed on the TV screen.

- A. Press MENU on remote to display the VCR MAIN MENU.
- B. Press 6 to display the LANGUAGE or IDIOMA or LANGUE menu. (English: LANGUAGE; Spanish: IDIOMA; French: LANGUE). The arrow indicates which language is selected.
 - Press 1 to have the menus displayed in English (Ingles).
 - Press 2 to have the menus displayed in Spanish (Español).
 - Press 3 to have the menus displayed in French (Français).

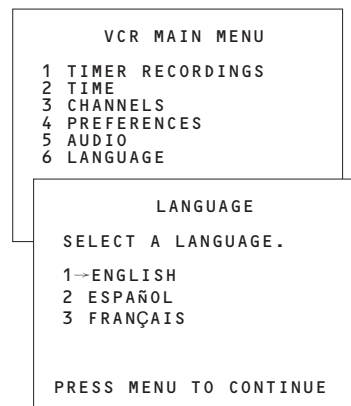

8. Use TV•VCR button.

Skip this step if you used one of the advanced hookups.

When using one of the basic hookups, the TV•VCR button lets you switch between the picture coming from the VCR or television channels. Also, this button lets you record a program on the VCR while watching another channel on the TV. *Details are on page 20.*

- A. Press TV•VCR to see the picture from the VCR.
The VCR indicator lights in the display panel.
- B. Press CHANNEL up or down to change channels on the VCR.
The channel number changes on the TV screen.
- C. Press TV•VCR to see the TV channels.
The VCR indicator does not light in the display panel.
Change channels using the TV's remote.
- D. Return the TV to the VCR viewing channel — CH3 or CH4.
- E. Press TV•VCR to switch back to the picture from the VCR.

9. Set the Display Panel brightness.

This feature changes the brightness level of the fluorescent display panel.

- A. Press MENU on remote to display VCR MAIN MENU.
- B. Press 4 to display PREFERENCES.
- C. Press 3 to select the FRONT PANEL: AUTO, BRITE, or DIM.
 - Select AUTO to keep the display panel bright when the VCR is on and dim when it is off.
 - Select BRITE to keep the display panel bright.
 - Select DIM to keep the display panel dim (not bright).

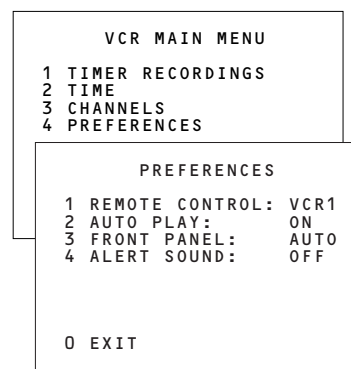

Startup

10. Set the ALERT SOUND feature.

Select this feature if you want a warning to sound each time an invalid entry or invalid operation is made. This feature is set to OFF. Please note the warning sound is heard only when the VCR is on.

- A. Press MENU on the remote to display VCR MAIN MENU.
- B. Press 4 to display the PREFERENCES menu.
- C. Press 4 to select ALERT SOUND: ON or OFF.
 - Select ON if you want to hear a warning.
 - Select OFF if you *do not* want to hear a warning.

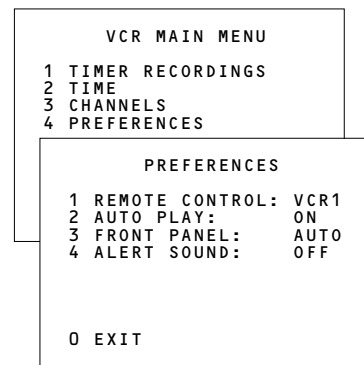

11. Set the Time and Date.

When you first turn on the VCR, the - : - - appears in the clock area of the VCR's display panel.

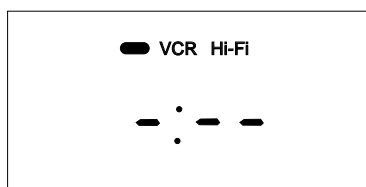

- A. Press MENU on remote to display the VCR MAIN MENU.
- B. Press 2 to display the TIME menu.
- C. Press 1 to display SET TIME AND DATE.
- D. Enter the time and date with the number buttons on the remote.
 - Press 0 before single-digit numbers.
Example: press 0, then 5, then 0, then 7 for a time of 5:07. Press 1 for AM or 2 for PM.
 - Press CLEAR on the remote to change incorrect entries.
- E. Press MENU to start the clock.
- F. Press 0 twice to exit.

The time appears in the VCR display panel, and the time and date appear on the TV screen when you press DISPLAY.

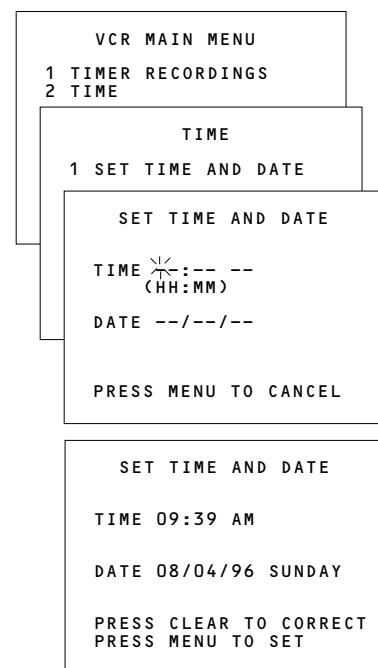

Startup

12. Set the Automatic Daylight-Saving Time

Select this feature if you want the VCR's clock automatically to advance one hour in April and reverse one hour in October.

A. Press MENU on the remote to display the VCR MAIN MENU.

B. Press 2 to display the TIME menu.

C. Press 2 to select AUTO DST: ON or OFF.

- Select ON if you want the VCR's clock to automatically adjust for Daylight Saving Time.
- Select OFF if you *do not* want the VCR's clock to automatically adjust for Daylight Saving Time.

In the Spring, daylight-saving time begins on the first Sunday in April. Clocks are set forward one hour.

Because the clock automatically changes from 2:00 AM to 3:00 AM, keep in mind that any part of a scheduled Timer Recording that falls between these two times is not performed.

In the autumn, daylight-saving time begins on the last Sunday in October. Clocks are set back one hour.

The VCR clock automatically changes from 2:00 AM to 1:00 AM. Therefore, it can affect your recording length.

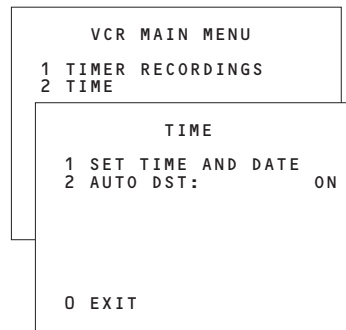

VCR Function Buttons

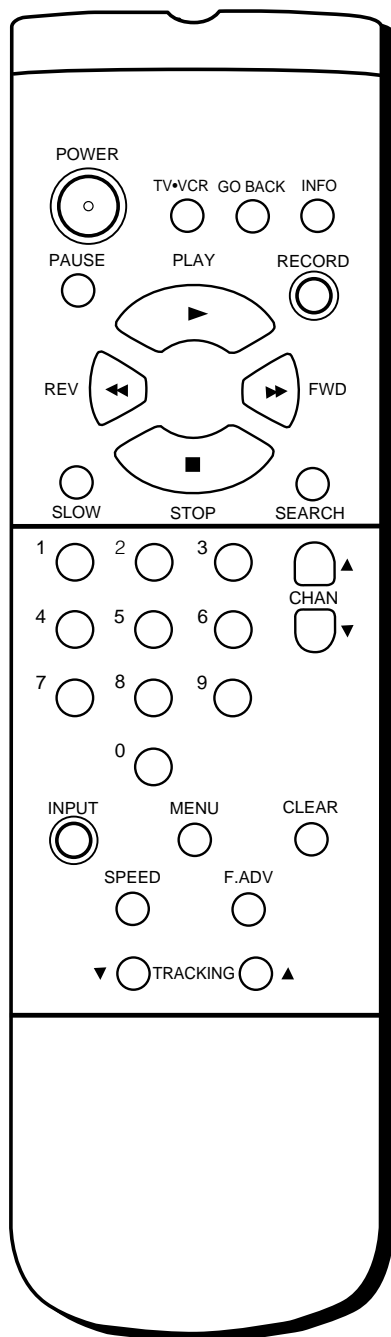

CHAN (CHANNEL) Up or Down

Selects the next higher or lower channel in the VCR's channel memory.

CLEAR

Resets the time counter to 0:00:00.

Lets you change entries when setting the time or VCR for a timer recording.

DISPLAY

Shows the VCR operating displays on the TV screen.

Displays the time counter when a tape is inserted.

FF (Fast Forward)

Fast forwards the tape when the VCR is stopped.

Searches the picture in forward motion during playback.

F. ADV (Frame Advance)

Lets you view one frame with each press of the button when the tape is in pause mode.

INPUT

Turns the line input on or off.

Line input refers to the signal coming from the component connected to the audio/video jacks on the back of the VCR.

MENU

Displays the VCR MAIN MENU on the TV screen.

Removes a menu from the screen.

Numbers (0 through 9)

Selects a channel up to 99—press two numbers.

Selects a cable channel over 99—press and hold 1 until 1-- appears on the screen. Then, press the other two numbers.

PAUSE

Pauses action for viewing during playback.

Pauses recording to prevent recording of unwanted scenes.

PLAY

Plays a tape.

POWER

Turns the VCR on and off.

PREV CH (Previous Channel)

Switches between two channels.

Select one channel, then select another. Press PREV CH to switch between the two channels.

REC

Starts the VCR recording. *See page 20.*

Used for One Touch recording. *See page 21.*

REW (Rewind)

Rewinds the tape when the VCR is stopped.

Searches the picture in reverse motion during playback.

SEARCH

Displays the INDEX and ZERO search menus on TV.

Advances the tape 60 seconds with one press and 120 seconds with two presses during playback.

SLOW

Plays a tape in slow-motion.

SPEED (Tape Speed)

Selects a recording speed (SP, SLP).

STOP

Stops the VCR's normal functions such as record, playback, rewind, fast forward, and pause.

TRACKING Up or Down

Reduces the streaks that may appear on the picture during play or pause.

Reduces picture "jitter" during pause.

TV+VCR

Switches the picture signal so that it either comes from the VCR or the TV channel. *See page 10.*

Playback

To play a tape

1. Turn on the TV and tune it to channel 3, 4, or the TV's video input to see the picture from the VCR.
2. Insert a tape in the VCR.
The VCR automatically turns on. The POWER and VCR indicators light. The tape automatically begins playback if the safety tab on the cassette has been removed and the AUTO PLAY feature is turned on.

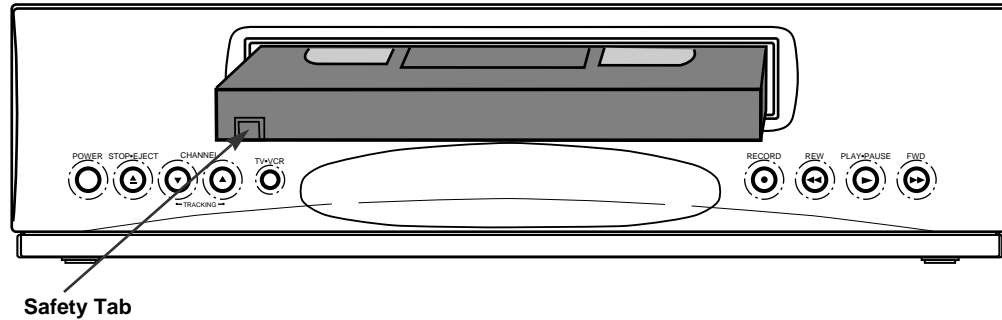

3. Press PLAY on the remote or PLAY•PAUSE on the VCR, if necessary.
4. Press TRACKING up or down on the remote or the VCR to remove any streaks from the picture if necessary. *Details are on page 18.*
5. Press STOP•EJECT on the VCR or STOP on the remote.
6. Press REW on the VCR or the remote.

End of Tape

The VCR automatically rewinds the tape if it reaches the end of the tape during playback.

Power Off

If you press POWER while a tape is rewinding, the VCR turns off automatically when it is completely rewound. REWIND→POWER OFF is displayed on the TV screen.

7. Press STOP•EJECT on the VCR to eject the tape once it is completely rewound.

Using the Playback Features

AUTO PLAY Feature

This feature allows the VCR to automatically start playing when you insert a tape with the safety tab removed.

1. Press MENU on the remote to display the VCR MAIN MENU.
2. Press 4 to display the PREFERENCES menu.
3. Press 2 to select AUTO PLAY: ON or OFF.
 - Select ON if you want to have a tape with its safety tab removed to start playing automatically.
 - Select OFF if you *do not* want a tape with its safety tab removed to start playing automatically.

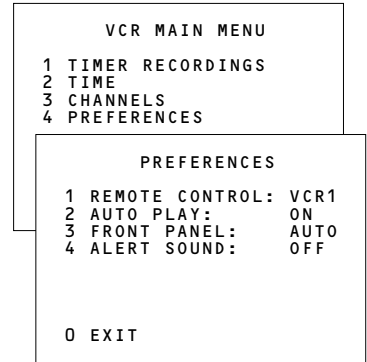

Picture Search

You can search for a specific tape location during playback by fast forwarding or rewinding the tape. Sound is turned off during picture search. The time counter is removed from the TV screen during picture search. The picture search works best for tapes recorded in the SP or SLP speed.

Fast Forward Search

1. Press FF to search forward at a faster-than-normal speed.
2. Press FF or PLAY on the remote or PLAY•PAUSE on the VCR to return to playback.

Rewind Search

1. Press REW to search backward at a faster-than-normal speed.
2. Press REW or PLAY on the remote or PLAY•PAUSE on the VCR to return to playback.

Slow Motion

You can view a tape in slow motion during play or play pause. Sound is turned off during slow-motion playback. Slow motion works best in the SP or SLP speed.

1. Press SLOW to begin slow-motion playback.
2. Use TRACKING up or down to remove any streaks from the picture.
3. Press PLAY on the remote or PLAY•PAUSE on the VCR to return to playback.

The VCR automatically switches from slow-motion playback to stop after a few minutes.

Using the Playback Features

DISPLAY Button

The DISPLAY button shows the status of the VCR channel number, time counter, date, time and tape speed on the TV screen. The time and date must be set before they can be displayed.

1. Press DISPLAY.
If you do not press DISPLAY again, this display times out.
2. Press DISPLAY again to display only the time counter on the TV screen.
3. Press DISPLAY again to return to TV viewing.

Turning off the VCR automatically returns the displays to normal.

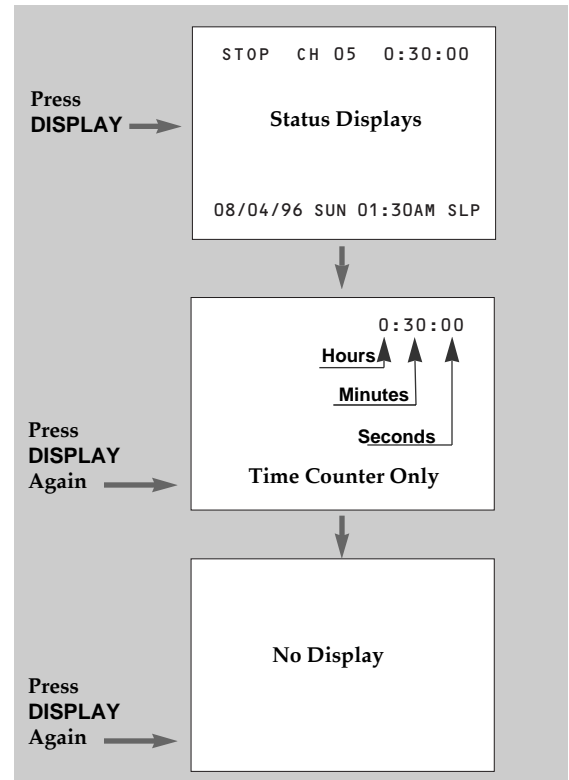

Time Counter

The time counter shows the actual time it takes to record a program or play back a segment of a prerecorded tape. It helps locate the beginning or end of programs you taped. The time counter resets to 0:00:00 when the tape is ejected from the VCR.

For example, if you record a 30-minute program at the beginning of the tape and you want to go to the end of that program to begin another recording, you would:

1. Insert the prerecorded tape.
2. Press DISPLAY twice to display only the time counter on the TV screen.
3. Press FF to fast forward the tape until 0:30:00 appears in the time counter and press STOP.
The time counter is removed from the TV screen during fast forward.
The time counter does not advance when it detects no signal (blank tape).
4. Press CLEAR to reset the time counter to 0:00:00.
5. Press DISPLAY to remove the time counter from the screen.

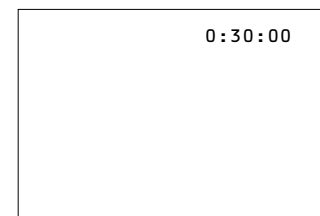

Using the Playback Features

Index Search

The VCR has a "VHS Index Search System" that automatically records an index mark on the tape every time you begin recording a program. Your VCR has two index playback features. To locate the program you want to play, select a specific index number or search by scanning.

Some index marks may be missed by the VCR.

- A mark too close to the current location on the tape.
- The mark at the beginning of a recorded segment of five minutes or less.
- The first index mark on the tape when you start searching from the beginning of the tape.

To Index Search

1. Insert the prerecorded tape and press STOP.
2. Press SEARCH on the remote to display the INDEX SEARCH menu on the TV screen.
3. Press REW or FF on the remote to scan or enter the number of index marks you want the VCR to search. Press CLEAR on the remote to correct an entry. Once the index mark or marks is found, the tape will begin playback.
4. Follow the directions on the screen.

```

INDEX SEARCH
PRESS REW OR FF
TO BEGIN SCANNING
OR
ENTER A SPECIFIC
INDEX NUMBER
>1<
PRESS SEARCH TO EXIT
    
```

```

INDEX SEARCH
SEARCHING FOR
INDEX MARKS...

PRESS STOP TO CANCEL
    
```

Zero Search

The zero search feature allows the VCR to quickly return to a counter reading of 0:00:00 anywhere on the tape. This is especially convenient when you want to watch a segment of the tape several times.

1. Insert the prerecorded tape.
2. Press DISPLAY **twice** to display only the time counter on the TV screen.
3. Use PLAY, FF, or REW to advance to the place on the tape where you want to return quickly.
4. Press CLEAR to reset the time counter to 0:00:00.
5. Continue playing the tape.
6. Press STOP.
7. Press SEARCH twice to display the ZERO SEARCH menu on the TV screen.
8. Follow the directions on the screen.

```

ZERO SEARCH
CURRENT TAPE COUNTER IS
2:17:25
PRESS REW TO GO TO
0:00:00
PRESS SEARCH TO EXIT
    
```

```

ZERO SEARCH
CURRENT TAPE COUNTER IS
-2:17:25
PRESS FF TO GO TO
0:00:00
PRESS SEARCH TO EXIT
    
```

Commercial Scan (SEARCH Button)

This is useful for scanning commercials or short program segments.

Press SEARCH during playback to advance the tape approximately one minute or press SEARCH twice for two minutes.

Using the Playback Features

Pause for Stop Action

This feature stops the tape in action and lets you examine the details of the scene. Stop action works best for tapes recorded in the SP or SLP speed.

1. Press PAUSE during playback to stop the action.
2. Press TRACKING up or down on the remote to reduce any jittering of the picture.
3. Press PAUSE or PLAY on the remote or PLAY•PAUSE on the VCR to return to playback.

The VCR automatically switches from stop-action playback to stop after a few minutes.

Frame Advance (F. ADV Button)

Frame advance lets you view one stop-action frame after another. Frame advance works best for tapes recorded in the SP or SLP speed.

1. Press PAUSE during playback to stop the action.
2. Press F. ADV each time you want to view a frame of the scene.
3. Press PAUSE or PLAY on the remote or PLAY•PAUSE on the VCR to resume normal playback.

Automatic Tracking

The VCR has automatic tracking which adjusts the picture when you are playing back a tape recorded on another VCR. Automatic tracking is turned on when a tape is inserted or the VCR's power is turned on.

Manual Tracking

Occasionally, you may need to manually adjust tracking on a tape recorded on a different VCR or camcorder. Tracking is used when playing a tape, and it has no effect during recording.

- When streaks or snow appear in the picture, press TRACKING up or down on the remote or the VCR for the best possible picture.
- During pause, press TRACKING up or down on the remote to reduce any jittering of the picture.
- When the sound is noisy, press TRACKING up or down on the remote for the best possible sound.

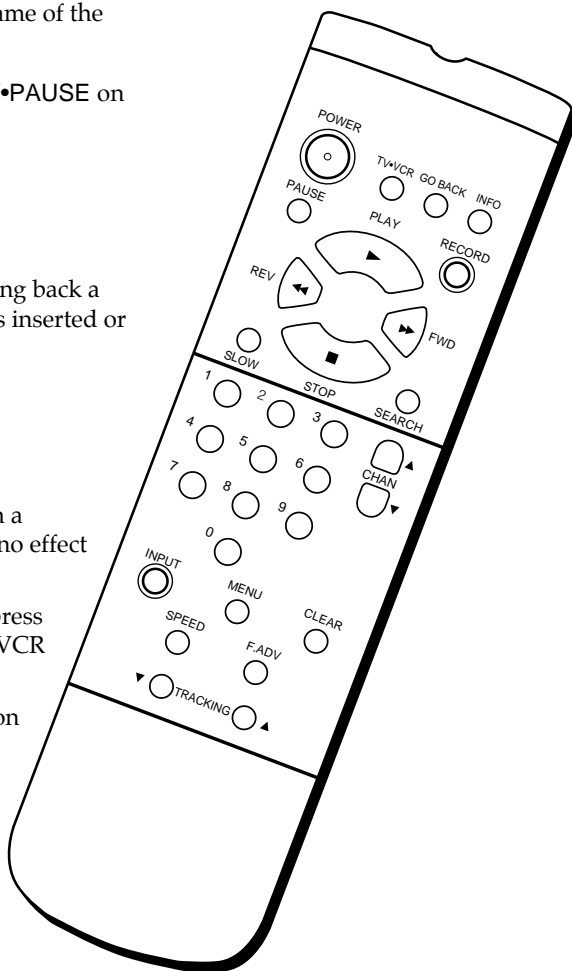

Using the Playback Features

TAPE PLAYBACK: HI-FI/LINEAR Feature

The VCR records the same audio on both the Hi-Fi and linear tracks on the tape. The Hi-Fi sound is recorded on separate left and right stereo channels. Mono sound is recorded on the linear track.

To enjoy Hi-Fi sound, connect your VCR to a stereo television or amplifier/receiver using the audio/video jacks. The TAPE PLAYBACK: HI-FI/LINEAR feature lets you select which audio you play back.

To Select Playback Sound

1. Press MENU to see the VCR MAIN MENU.
2. Press 5 to see the AUDIO menu on the TV screen.
3. Press 2 to switch between HI-FI and LINEAR sound.
 - Select HI-FI to play back sound recorded on the Hi-Fi track and for normal use.
The Hi-Fi indicator lights in the VCR's display panel.
 - Select LINEAR to play back the sound recorded on the linear track, such as a second audio program (SAP).
The Hi-Fi indicator turns off in the VCR's display panel.

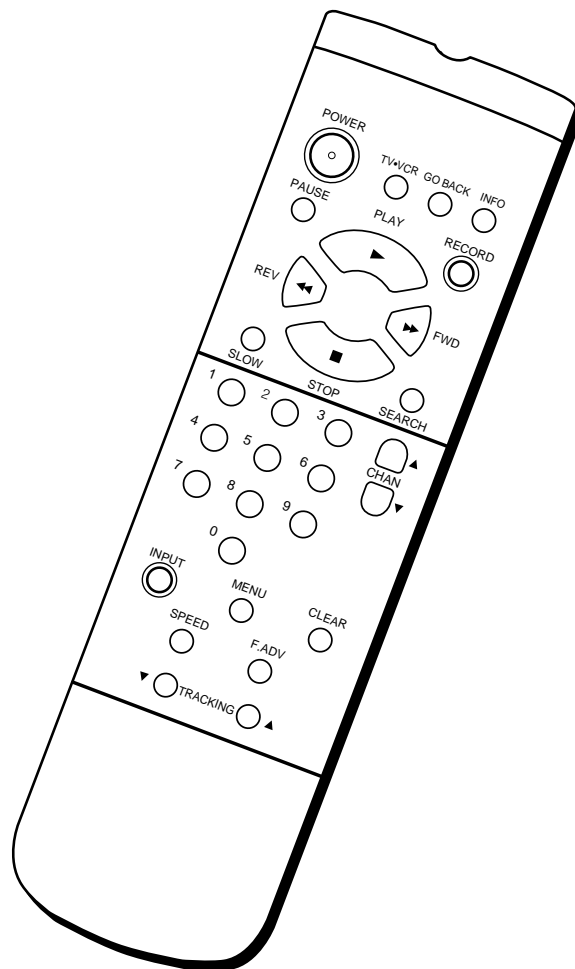
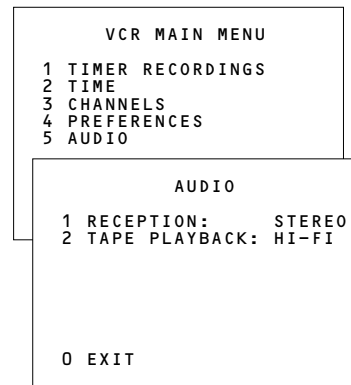

Recordings

Your VCR provides different recording options. These options are explained in this section of the manual.

Recording Speeds

Press **SPEED** on the remote to select a recording speed (SP or SLP). The speed you select appears on the TV screen. Tapes recorded in LP can be played in this VCR.

SP (Standard Play) gives the best quality recording. That is why most prerecorded, rental tapes are recorded in SP. Fewer programs can be recorded on the tape. Special effects such as pause, frame advance, slow motion, and picture search work well in this speed.

SLP (Super Long Play) gives three times the recording time of tapes recorded in SP. Special effects such as pause, frame advance, slow motion, and picture search work well in this speed.

Cassette	Recording Time	
	SP	SLP
T-120	2Hrs	6Hrs
T-160	2Hrs 40Min	8Hrs

Normal Recording

To Make a Recording

Turn on the TV and tune it to the VCR viewing channel, either 3, 4, or the TV's video input channel.

1. Insert a tape with its safety tab in place.
2. If you are using one of the basic hookups, make sure the VCR indicator lights in the VCR's display panel. If not, press **TV•VCR** to turn it on.
3. Use **SPEED** on the remote to select a recording speed.
The tape speed indicator appears on the TV screen.
4. Select the channel to be recorded.
The channel number appears on the TV screen.
5. Press **RECORD** on the VCR or **REC** on the remote to begin recording.
The **RECORD** indicator lights in the VCR's display panel while the VCR is recording.

Watch a TV Channel While VCR is Recording a Different Channel

For some cable box hookups, this recording feature may not apply. Contact your local cable company for assistance.

1. Follow steps 1 through 5 above.
2. If you are using one of the basic hookups, press **TV•VCR** to switch to the TV channel.
The VCR indicator turns off in the display panel.
3. Select the channel you want to watch with the TV's channel buttons.
4. Press **STOP•EJECT** on the VCR or **STOP** on the remote when the recording is finished.

One Touch Recording

One touch recording lets you record up to four hours without using the timer program feature. The VCR turns off automatically at the end of the recording.

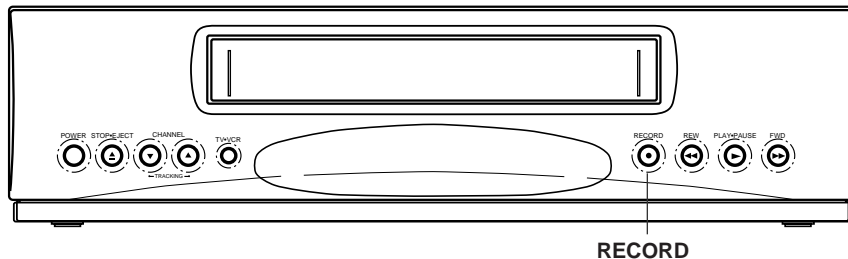

1. Turn on the VCR.
2. Insert a tape with its safety tab in place.
3. Select the channel you want to record.
4. Use SPEED on the remote to select a recording speed.
5. Press REC on the remote or RECORD on the VCR to activate recording.
6. Press RECORD or REC repeatedly until the amount of recording time for the program is displayed on the TV screen.
Each press of RECORD or REC increases the time — 30 minutes up to 4 hours.

Press RECORD	Recording Time
0:30	(30 Min)
1:00	(1 Hr)
1:30	(1 Hr, 30 Min)
2:00	(2 Hrs)
3:00	(3 Hrs)
4:00	(4 Hrs)

Normal Record

The REC and TIMER indicators light in the VCR's display panel. During recording, press RECORD on the VCR or REC on the remote to display the time remaining on the TV screen. Press RECORD or REC again to increase the recording time.

Stopping a One Touch Recording in Progress

You can stop a recording by:

- Pressing and holding the STOP button on the remote or STOP•EJECT on the VCR for approximately three seconds.
- Pressing the RECORD button until 0:00 is displayed for the recording.

Recording While You're Away (Timer Recording)

The timer program feature lets you program the VCR to record up to eight different programs within a one year period. Before setting the timer, make sure that:

- The clock is set correctly.
- A tape with a safety tab has been inserted with enough tape to record the programs.

Setting a Timer Recording

1. Press MENU on the remote to display the VCR MAIN MENU.
2. Press 1 to display the TIMER RECORDINGS menu.
3. Press 1 to display the CREATE A NEW PROGRAM menu.
4. Press 1, 2, 3, or 4 to select type of program.
 - 1 ONE TIME — single program recorded once.
 - 2 DAILY — program recorded at same time every day.
 - 3 WEEKDAYS — program recorded at same time Monday through Friday.
 - 4 WEEKLY — program recorded at same time once a week.
5. Press number buttons on the remote to enter the channel number (or INPUT on the remote to select line input), start time including AM or PM, end time, start date, and recording speed of the recording. Follow the on-screen prompts. Press CLEAR on the remote to correct an entry.
6. Press MENU to enter your program. If you have entered two programs whose times overlap, PROGRAMS OVERLAP appears on the screen.
7. Repeat steps 3–6 for additional programs and follow the directions on the screen.
8. If you are using a cable box, leave it turned on and tuned to the channel you want to record. Otherwise, **turn off the VCR** before recording begins.

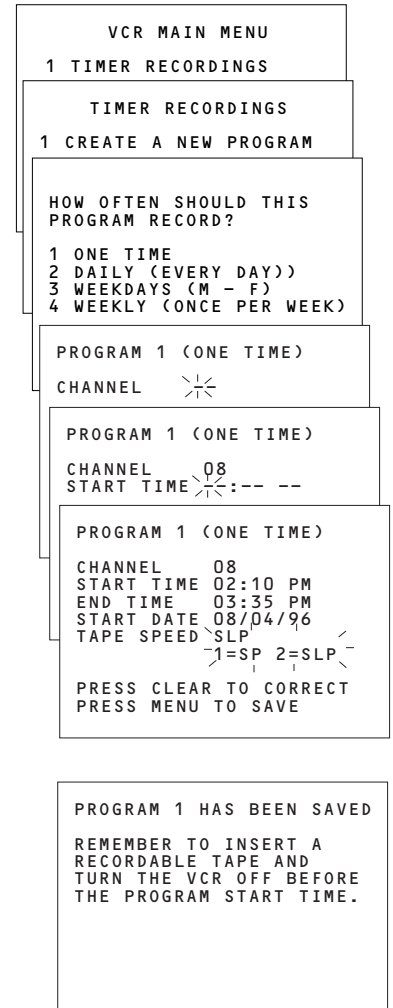

Stopping a Timer Recording

You can stop a recording by pressing and holding the STOP button on the remote or STOP•EJECT on the VCR for approximately three seconds.

Recording While You're Away (Timer Recording)

Timer Recording From the VCR's Line Input

The line input refers to the signal coming from the AUDIO1 and VIDEO1 IN jacks of the VCR. Recording from the line input is convenient if you have a satellite receiver or similar component attached to these jacks.

To timer record from the component connected to the VCR's line input, press INPUT or "0,0" on the remote to enter VIDEO in the channel number position.

```
PROGRAM 1 (ONE TIME)
CHANNEL      VIDEO
START TIME  >|<:-- --
END TIME    --:-- --
START DATE  --/--/--
TAPE SPEED  SLP

PRESS CLEAR TO CORRECT
PRESS MENU TO EXIT
```

Checking or Clearing Timer Recordings

1. Press MENU on the remote to display the VCR MAIN MENU.
2. Press 1 to display the TIMER RECORDINGS menu.
3. Press 2 to display the program's menu.
4. Press MENU for next program or CLEAR to erase the program.

```
VCR MAIN MENU
1 TIMER RECORDINGS

TIMER RECORDINGS
1 CREATE A NEW PROGRAM
2 REVIEW EXISTING PROGS.

PROGRAM 1 (ONE TIME)
CHANNEL      08
START TIME   02:10 PM
END TIME     03:35 PM
START DATE   08/04/96 SUN
TAPE SPEED   SLP

PRESS CLEAR TO ERASE
PRESS MENU FOR NEXT PROG
```

Stereo Broadcast TV or SAP (Second Audio Program)

Some TV programs are broadcast with stereo audio or a second audio language (SAP). The RECEPTION: STEREO/MONO/SAP feature lets you select the type of audio you want to record.

To Record Stereo Broadcast TV or SAP

Turn on the TV and tune it to the VCR viewing channel, either 3, 4, or the TV's video input.

1. Insert a tape with its safety tab in place.
2. If you are using one of the basic hookups, make sure the VCR indicator lights in the VCR's display panel. If not, press TV•VCR to turn it on.
3. Use SPEED on the remote to select a recording speed. The tape speed indicator appears on the TV screen.
4. Select the channel or line input (channel 00) to be recorded. The channel number or VIDEO appears on the TV screen and L appears in the VCR display panel.
5. Set the RECEPTION: STEREO/MONO/SAP feature for the type of audio you want to record.
 - A. Press MENU to display the VCR MAIN MENU.
 - B. Press 5 to display the AUDIO menu.
 - C. Press 1 to select the type of audio RECEPTION: STEREO, MONO, or SAP.
 - Select STEREO for normal and stereo broadcast TV recording. STEREO appears on the TV screen when the station you are tuned to is broadcasting stereo.
 - Select MONO if the stereo signal is weak and the sound is too "noisy."
 - Select SAP to record SAP (second audio program) on the linear track. SAP appears on the TV screen when the station you are tuned to is broadcasting SAP.
6. Press RECORD on the VCR or REC on the remote to start recording. The REC indicator lights in the display panel.
7. Press STOP•EJECT on the VCR or STOP on the remote when you are finished.

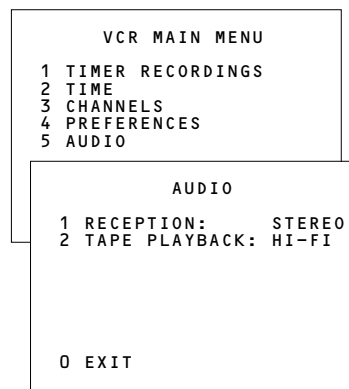

RECORDING AUDIO

You can record audio only from another audio source connected to the AUDIO1 IN (L and R) jacks on the back of the VCR. Recording audio erases previously recorded video.

To Record Audio Only (Refer to hookup on page 7.)

1. Press the INPUT button or 0,0 on the remote to hear the source attached to the AUDIO jacks. L appears in the VCR display panel and VIDEO appears on the TV screen.
The VCR records audio from the audio equipment connected to the AUDIO1 (L and R) IN jacks.
2. Use SPEED on the remote to select the recording speed. The tape speed indicator appears on the TV screen.
3. Start playing the audio source. Then, press RECORD on the VCR or REC on the remote to begin recording. REC lights in the VCR's display panel.
4. Press STOP•EJECT on the VCR or STOP on the remote when you are finished.

Using the Recording Features

Recording Pause

To prevent recording short passages of unwanted material, use PAUSE during recording to stop and start recording. The VCR automatically switches from pause to stop after a few minutes.

Pro-Tect Plus™ (Child Lock) Feature

This feature is useful to tamper proof your timer recordings from unwanted changes and/or protect the VCR from misoperation by other users in the household. It also prohibits all operations of the VCR once the feature is turned on.

To Lock the VCR

Press and hold POWER on the remote for approximately six seconds to activate the Pro-Tect Plus™ feature. The VCR turns off.

The word "SAFE" appears in the VCR display to let you know the feature is activated. After the feature is activated, momentarily pressing POWER also causes the word "SAFE" to appear.

To Unlock the VCR

Press and hold POWER on the remote for approximately six seconds to unlock the VCR. The VCR turns on.

Using Two VCRs for Copying and Editing Tapes

Operating Instructions (Refer to hookup on page 6.)

Use one VCR as the playback VCR and the other as the recording VCR.

Caution: The unauthorized recording of television programs and other materials may infringe the rights of others.

1. Turn on the TV and VCRs.
2. Tune the TV to the VCR viewing channel, either 3, 4, or the TV's video input.
3. If you connected your VCR using Option A (page 6), tune the recording VCR to channel 3 or 4 – the one selected on the back of the playback VCR.
If you connected your VCR using Option B (page 6), press INPUT (or channel 00) on the recording VCR's remote to select the line input.
4. Insert the tape you want to copy into the playback VCR. Insert a blank tape with its safety tab in place into the recording VCR.
5. Press PLAY, then PAUSE on the playback VCR when you reach the point on the tape or program where you want to begin copying. If the tape was not recorded on the playback VCR, streaks may appear and you may need to adjust tracking.
6. Press RECORD on the VCR or REC on the remote, then PAUSE on the recording VCR.
7. Press PAUSE on both VCRs at the same time to begin copying the tape.*
8. Edit out segments that you do not want to copy by pressing PAUSE on the recording VCR to stop copying the tape. Then, locate the next segment you want to copy on the playback VCR by using FWD, REW, and PLAY. Press PAUSE on the playback VCR. Press PAUSE at the same time on both VCRs to resume copying.
9. Press STOP•EJECT on both VCRs when you are finished.

*You may turn off the TV after the recording has started as it does not have to be on to copy a tape.

Copying and Editing Tapes Using Compatible Remote

If you have a compatible GE, RCA, or ProScan remote with VCR1 and VCR2 buttons, you can program this VCR to respond to either VCR1 or VCR2. This lets you control both VCRs with one remote for easier copying and editing.

Set the REMOTE CONTROL feature of this VCR to VCR1 or VCR2 position. Then, the compatible remote controls the VCR with either the VCR1 or VCR2 button — depending on the position you select in the menu.

1. Press MENU to display the VCR MAIN MENU.
2. Press 4 to display PREFERENCES.
3. Press 1 to activate the REMOTE CONTROL: VCR1 or VCR2 feature.
4. Press VCR1 or VCR2 on your compatible VCR's remote to change the setting and program this VCR to respond to VCR1 or VCR2 — depending on the position you selected in step 3.

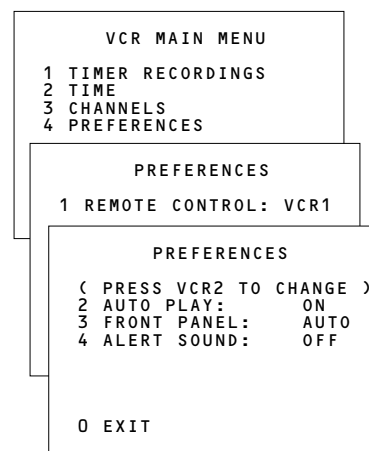

Location of Controls

Front Panel

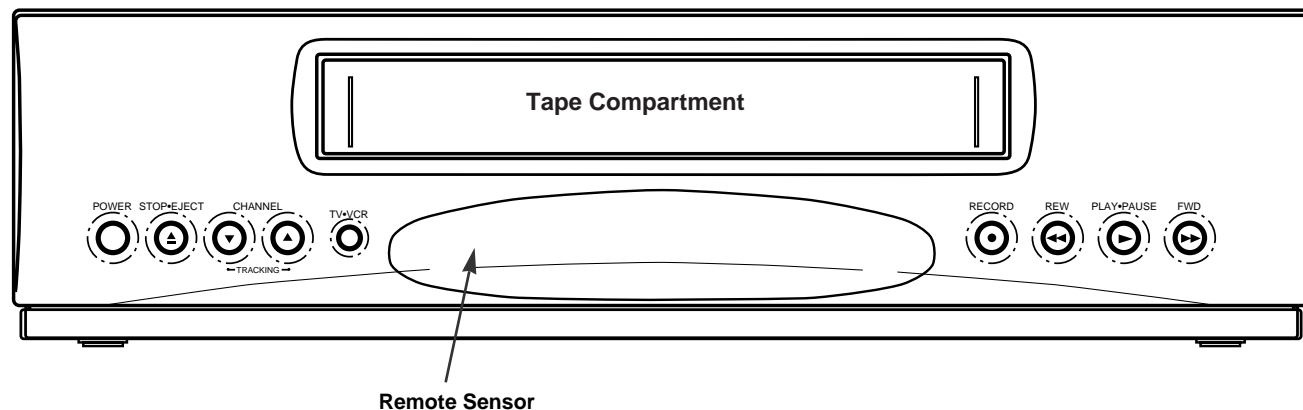

CHANNEL or TRACKING up or down

Selects next higher or lower channel in the VCR's channel memory.

Adjusts tracking during playback.

FWD (Fast Forward)

Fast forwards the tape when the VCR is stopped.

Searches the picture forward during playback.

PLAY•PAUSE

Plays a tape.

Pauses the tape for stop-action viewing during playback.

Pauses the tape during recording to prevent recording unwanted material.

POWER

Turns the VCR on or off.

RECORD

Start the VCR recording.

Used for one touch recording.

Remote Sensor

Receives signals from the remote control. Aim the remote at this sensor with no objects between them.

REW

Rewinds the tape when the VCR is stopped.

Searches the picture in reverse during playback.

STOP•EJECT

Stops the normal functions such as record, playback, rewind, fast-forward, or pause.

Press when the VCR is stopped to eject the cassette.

TV•VCR

Switches the picture signal so that it either comes from the VCR or the TV channel.

See page 10.

Location of Controls

Back Panel

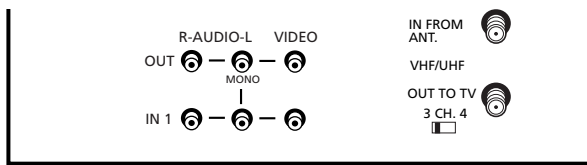

3CH.4 Switch

Selects the channel to which you tune the TV to see the VCR picture if you connect the VCR using one of the basic hookups.

IN FROM ANT. (Antenna) Connector

Receives a signal from an antenna or cable system when attached.

OUT TO TV Connector

Passes signal to TV using the cable supplied.

VIDEO1 IN and AUDIO1 (R and L) IN Jacks

Receive signals from another component like a VCR or camcorder when it is connected to these jacks. Use INPUT (channel 00) on the remote to select.

VIDEO1 OUT and AUDIO1 (R and L) OUT Jacks

Send signals from VCR to another component like a TV, VCR or camcorder when it is connected to these jacks.

Display Panel

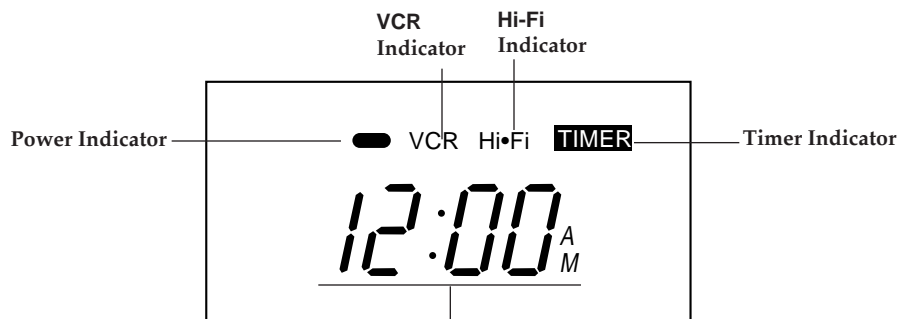

Current Time, Channel Number, or Line Indicator (L), or Status

Hi-Fi Indicator

Lights when TAPE PLAYBACK feature is set to HI-FI.

POWER Indicator

Lights when the VCR is turned on.

Time, Channel Number, or Line Input (L)

The current time is displayed. Only the AM indicator appears; when the time is PM, no indicator appears.

The channel number or line input is displayed. Pressing INPUT or channel 0, 0 on the remote displays the line input indicator to record from the VIDEO1 and AUDIO1 IN jacks

STATUS Indicators

PLAY A tape is playing.
 REC A tape is recording
 REW A tape is rewinding.
 FF A tape is fast forwarding.
 STOP A tape is stopped.

TIMER Indicator

Shows VCR is set for timer recording when VCR is turned off.

Flashes when a timer recording is set and there is no cassette in the VCR.

VCR Indicator

Lights when using the TV•VCR button.

When using one of the basic hookups:

- The picture is coming from the VCR when the VCR indicator is on.
- The picture is coming from the television channels when the VCR indicator is off.

Specifications

Format:	VHS
Record/Playback System:	Video: 4-Head Audio: VHS Hi-Fi Stereo record/playback system
Video Signal System:	EIA standard: NTSC color
Antenna:	75-ohm external VHF/UHF combined antenna terminal
Tuner:	USA: 181 channels capability* (125 cable channels) Canada: 178 channels capability* (122 cable channels)
Type:	Autoprogramming frequency synthesis
Power Requirement:	120V AC, 60 Hz
Power Consumption:	23 watts
Dimensions:	3.5 inches high (89 mm) 14.2 inches wide (360 mm) 11.2 inches deep (285 mm)
Weight:	8.2 pounds (3.7 kg)
Storage Temperature Range:	- 22°F to +149°F (-30°C to +65°C)
Operating Temperature Range:	+41°F to +104°F (+5°C to +40°C)

*Check your cable company's compatibility requirements.

Cleaning the VCR

Use a soft cloth or dusting attachment of your vacuum cleaner to clean the exterior of the VCR. Remove dust from the ventilation holes on the top, back, sides, and bottom of the cabinet.

Plastic surfaces are easily scratched and can be marred by alcohol and various solvents. Avoid excessive use of oil-based furniture polishes since the materials used in the cabinet will accumulate more dust. We recommend using a non-abrasive, anti-static cleaner and polisher.

Trouble Checks

Sometimes problems can be easily solved by checking a few basic things. Check below before you call for help or take your VCR to an Authorized GE VCR Servicenter.

Trouble	Here's what to try:
No power	<ul style="list-style-type: none"> • Plug VCR into an operating outlet. • Check connections.
VCR does not respond to remote	<ul style="list-style-type: none"> • Remove batteries and hold down one or more buttons for several seconds to drain the microprocessor inside the remote and reset it. Re-install the batteries and try remote again. • Aim remote at VCR with no objects between them. • Change batteries. • Check setting of REMOTE CONTROL: VCR1 (VCR2) feature. <i>See page 26.</i> • Check the Pro-Tect™ feature.
Poor or no picture for normal TV viewing	<ul style="list-style-type: none"> • Press TV•VCR to turn VCR indicator off. • Switch TV to an active channel. • Check antenna connections.
Snowy or no picture during playback	<ul style="list-style-type: none"> • Press TV•VCR to turn VCR indicator on. • Check TV channel selected (3 or 4) to make sure it matches the channel selected with 3CH.4 switch on back of VCR. • Check TV's fine tuning. • Check video cable connections between VCR and TV monitor. • Set TV monitor to video input channel. • Try another tape. • Some snow / streaks are normal during search, stop action, frame advance, and slow-motion playback.
Streaks in picture during normal playback	<ul style="list-style-type: none"> • Press the TRACKING button on the remote or the VCR to move streaks for the best picture. • Check tape — it may be worn out or of poor quality.
Time counter not working or time counter does not change during zero search feature	<ul style="list-style-type: none"> • The time counter does not advance during unrecorded portions of tape. When an unrecorded segment of tape is encountered, the time counter will hold its count until recorded material is detected again. • A minus (-) appears in front of the time if you rewind the tape farther back than a counter reading of 0:00:00. • Time counter only appears when a tape is in the VCR.
Will not record or play	<ul style="list-style-type: none"> • No cassette in VCR. • Eject and reinsert cassette. • Broken tape — try another cassette. • VCR is in pause mode. Press PAUSE during recording or playback. • Check the Pro-Tect™ feature.
Will not record	<ul style="list-style-type: none"> • Safety tab removed from cassette. • Make sure the line indicator (VIDEO) does not appear on the TV screen for normal recording from the VCR's tuner. Press INPUT on the remote to turn the line input off. • Check the Pro-Tect™ feature.
No stereo sound during playback	<ul style="list-style-type: none"> • TAPE PLAYBACK feature must be set to HI-FI to hear stereo sound during playback. <i>See page 19.</i>

Trouble Checks

Trouble	Here's what to try:
Stereo audio too noisy	<ul style="list-style-type: none"> • Stereo signal is weak. Set RECEPTION: STEREO/MONO/SAP feature to MONO. • Press the TRACKING up or down button on the remote to minimize the noise.
Stereo or SAP sound not recorded	<ul style="list-style-type: none"> • RECEPTION: STEREO/MONO/SAP feature must be set to STEREO to record broadcast stereo. <i>See page 24.</i> • RECEPTION: STEREO/MONO/SAP feature must be set to SAP to record SAP. <i>See page 24.</i> • STEREO or SAP indicator not on. Station not broadcasting stereo or SAP.
Rewind does not operate	<ul style="list-style-type: none"> • Tape already rewound.
Timer recording not made or wrong program recorded	<ul style="list-style-type: none"> • Cable box was not turned on at time recording was to begin. • Program entered incorrectly (wrong channel or times). • Power interruption. Reset clock. <i>See page 11.</i> • Check to see if time and date are correct — including AM/PM. • Program exceeded tape's length or tape was not rewound beforehand. • VCR was not turned off at the time recording was to start. • No tape in VCR or cassette's safety tab broken off.
Incorrect time or date	<ul style="list-style-type: none"> • Power interruption--clock on the front panel shows --:--. • Clock was not set accurately (check AM/PM and date). <i>See page 11.</i>
Time did not adjust for daylight savings	<ul style="list-style-type: none"> • Check if AUTO DST is turned on.
VCR makes noise when stopped	<ul style="list-style-type: none"> • VCR is removing tape from heads. This is normal. The head cylinder inside the VCR continues to rotate for a few minutes after you put the VCR in the stop mode.
Will not Auto Channel Search correctly	<ul style="list-style-type: none"> • Check antenna connections. • Check SIGNAL TYPE: CABLE/ANTENNA feature. <i>See page 9.</i>
Cannot select channels over 69	<ul style="list-style-type: none"> • Cable channels over 69 can only be selected if SIGNAL TYPE: CABLE/ANTENNA feature is set to CABLE. <i>Details are on page 9.</i>
Cassette with safety tab removed does not start to play automatically	<ul style="list-style-type: none"> • Set AUTO PLAY ON/OFF feature to ON. <i>Details are on page 15.</i>
Tape plays back in slow motion	<ul style="list-style-type: none"> • Press PLAY to return to normal playback.
TIMER indicator flashes	<ul style="list-style-type: none"> • Timer recording programmed and no cassette in VCR.
On-screen menus are in English, French or Spanish	<ul style="list-style-type: none"> • Check LANGUAGE feature. <i>See page 10.</i>
Time counter disappears while searching	<ul style="list-style-type: none"> • This is normal. <i>Details are on page 16.</i>

Limited Warranty

What your warranty covers:

- Any defect in material or workmanship.

For how long after your purchase:

- Ninety days for labor charges.
- One year for parts.

The warranty period for rental units begins with the first rental.

What we will do:

- Pay any Authorized GE VCR Servicenter the labor charges to repair your VCR.
- Pay any Authorized GE VCR Servicenter for the new or, at our option, refurbished replacement parts required to repair your VCR.

How you get service:

- Take your VCR to any Authorized GE VCR Servicenter. To identify your nearest Authorized GE VCR Servicenter, ask your dealer, look in the Yellow Pages, or call 1-800-447-1700.
- Show the service technician your evidence of purchase date.
- Pick up your VCR when repairs are completed.

What your warranty does not cover:

- Customer instruction. (Your Owner's Manual clearly describes how to install, adjust, and operate your VCR. Any additional information should be obtained from your Dealer.)
- Installation and related adjustments.
- Signal reception problems not caused by your VCR.
- Damage from misuse or neglect.
- Cleaning of video/audio heads.
- Remote control batteries.
- A VCR that has been modified or incorporated into other products or is used for institutional or other commercial purposes.
- A VCR purchased or serviced outside the USA.
- Acts of God, such as but not limited to lightning damage.

Product Registration:

- Please complete and mail the Product Registration Card packed with your VCR. It will make it easier to contact you should it ever be necessary. The return of the card is not required for warranty coverage.

How state law relates to this warranty:

- This warranty gives you specific legal rights, and you also may have other rights that vary from state to state.

If you purchased your VCR outside the United States:

- This warranty does not apply. Contact your dealer for warranty information.

Index

- 3CH.4 Switch.....3-8,9,28
- Accessories, Included8
- Add or Remove Channels from
 - Memory.....9
- ADD/REMOVE CHANNEL Menu9
- ALERT SOUND Feature11
- Amplifier/Receiver Connections.....7
- Antenna Connections2,3
- AUDIO Menu.....19,24
- Audio Only, Recording25
- AUDIO1/VIDEO1 IN Jacks.....6,7,23,25,28
- AUDIO1/VIDEO1 OUT Jacks3-7,28
- AUTO CHANNEL SEARCH Feature9
- AUTO DST Feature12
- AUTO PLAY Feature.....15
- Back Panel28
- Batteries, Inserting in Remote.....8
- Brightness, Front Panel.....10
- BRITE10
- Cable System With Cable Box
 - Connections.....2,4,5
- Cable System Without Cable Box
 - Connections.....2,3
- Card, Registrationi
- CHAN Buttons.....9,13,27
- CHANNELS Menu.....9
- Checking Timer Recordings23
- Checks, Trouble30,31
- Child Lock Feature25
- Choosing a Hookup.....2
- Cleaning the VCR.....29
- CLEAR Button11,13,16,17,22,23
- Clearing Timer Programs.....23
- Commercial Scan.....17
- Compatible Remotes.....26
- Connections2-7
 - Antenna2,3
 - Amplifier/Receiver.....2,7
 - Audio/Video Jacks.....2,3-7
 - Cable-TV2,3-5
 - Two VCRs6
- Contents1
- Copying Tape, Connections.....6
- Copying Tapes.....26
- Date and Time, Setting11
- Design Specifications29
- DIM10
- DISPLAY Button.....13,16,17
- Display Panel10,28
- Editing Tapes.....26
- English Language.....10
- F. ADV (Frame Advance) Button.....13,18
- F F (Fast Forward) Button13,15,16
- FWD (Fast Forward) Button26,27
- Frame Advance Feature18
- French Language.....10
- Front Panel27
- FRONT PANEL Feature10
- Hi-Fi Indicator19,28
- Hookups
 - Antenna2-3
 - Amplifier/Receiver.....2,7
 - Audio/Video Jacks.....2,3-7
 - Cable-TV2,3-5
 - Two VCRs6
- Hookup, Choosing2
- Idioma10
- INDEX Feature17
- INDEX SEARCH Menu17
- IN FROM ANT. Connector.....3-6,28
- INPUT Button.....13,23,25
- LANGUAGE/IDIOMA/LANGUE Menu ..10
- Language, Selecting10
- Langue10
- Limited Warranty.....32
- Line Input, Recording From23
- Location of Controls
 - Remote Control13
 - VCR Back Panel.....28
 - VCR Display Panel.....28
 - VCR Front Panel.....27
- LP Speed20
- MENU Button9-13,15,19,22,24-26
- Number Buttons13
- One Touch Recording.....21
- Operating Instructions
 - Audio Only Recording25
 - Broadcast Stereo TV Recording24
 - Copying Tapes.....26
 - One Touch Recording.....21
 - Normal Recording20
 - Playing a Tape14
 - SAP Recording.....24
 - Timer Recording.....22,23
- OUT TO TV Connector.....3-6,28
- PAUSE Button.....13,18,25-27
- Pause for Stop Action18
- Pause, Recording25
- Picture Search15
- PLAY Button.....13-15,17,18,26,27
- Playing a Tape14-19
- POWER Button.....8,13,14,22,25,27
- Power Indicator8,28
- PREV CH (Previous Channel)
 - Button.....13
- Problems, Solving.....30,31
- Product Registrationi
- Pro-Tect Plus™ Feature.....25
- Product Registrationi
- REC Button13,20-23,26
- REC Indicator21,22,25
- RECEPTION: STEREO/MONO/SAP
 - Feature24
- RECORD Button20-25,26,27
- Recording
 - Audio Only25
 - Broadcast Stereo TV24
 - From Another VCR.....26
 - Normal.....20
 - One Program While
 - Watching Another.....20
 - One Touch21
 - Pause25
 - SAP (Second Audio Program).....24
 - Speeds.....20
 - Timer22,23
- Registration Cardi
- REMOTE CONTROL Feature.....26
- Remote Control.....13
- Remote Sensor27
- Remove or Add Channels from
 - Memory.....9
- REMOVE/ADD CHANNEL Menu9
- Review Programs Feature.....23
- REW Button13,14,17,26,27
- Safety Precautions.....i
- SAP Indicator.....28
- SAP, Recording.....24
- SEARCH Button13,15,17
- Searching, Picture.....15
- Seleccione el Idioma.....10
- Sélectionner la langue.....10
- Sensor, Remote27
- Setting a Timer Recording22
- Setting Up the VCR.....8-12
- PREFERENCES Menu10-12,15,26
- SLOW Button13,15
- Slow Motion.....15
- SLP Speed20
- Solving Problems.....30,31
- SP Speed20
- Spanish.....10
- Specifications29
- SPEED Button.....13,20-23
- Speeds, Recording20
- Startup8-12
- Stereo Amplifier/Receiver Connections.7
- STEREO Indicator28
- Stereo TV, Recording24
- Stop Action Pause18
- STOP Button13,14,16,17,20-22
- STOP•EJECT Button14,20-22,26,27
- Stopping Recording Program21
- Stopping Timer Programs.....22
- Table of Contents.....1
- TAPE PLAYBACK: HI-FI/LINEAR
 - Feature19,24
- Time and Date, Setting11
- Time Counter16,17
- TIMER Indicator21,22,28
- TIME Menu.....11
- Timer Recording
 - Checking and Clearing.....23
 - Front VCR Line Input.....23
 - Pro-Tect Plus™ Feature.....25
 - Setting22
 - Stopping22
- Tracking, Automatic and Manual.....18
- TRACKING Button.....13-15,18,27
- Trouble Checks30,31
- SIGNAL TYPE Feature9
- Turn On VCR8
- TV•VCR Button3-6,9,10,13,20,27
- VCR Controls27
- VCR Indicator.....8-10,14,20,28
- VCR MAIN MENU.....9-12,15,19,22,24-26
- VCR, Cleaning29
- VCR, Turn On.....8
- VCR1/VCR2 Feature26
- VCRs Memory, Placing Channels.....9
- VCRs, Connecting for Tape Copying.....6
- VIDEO1 IN Jacks6,7,25,26,28
- VIDEO1 OUT Jacks3-7,26,28
- Warranty, Limited.....32
- Zero Search.....17

For your nearest Home
Entertainment Dealer
or Authorized Servicenter
call toll-free in the U.S.A.

1-800-447-1700

Canadian Consumers –
Your toll free numbers are:

English: 1-800-522-0338

French: 1-800-522-0445

If you would like a copy of this manual in French, please follow the
instructions below:

Si un livret d'instructions en français n'est pas inclus avec votre appareil, vous
30 en obtenir un (indiquer le numéro de modèle, votre nom, et votre adresse)
en vous adressant à:

Thomson Consumer Electronics
Attention: Canadian Operations
P.O. Box 0944
Indianapolis, IN 46206-0944

Please do not send any products to the Indianapolis
address listed in this manual or on the carton. This will
only add delays in service for your product.

 **THOMSON CONSUMER ELECTRONICS**
10330 North Meridian Street
Indianapolis, IN 46290-1024

©1996 Thomson Consumer Electronics, Inc.

Trademark(s)[®] Registered

Marca(s) Registrada(s)

Printed in Japan

Part Number 96-VG4256-1

VQTS3240 (A)

Free Manuals Download Website

<http://myh66.com>

<http://usermanuals.us>

<http://www.somanuals.com>

<http://www.4manuals.cc>

<http://www.manual-lib.com>

<http://www.404manual.com>

<http://www.luxmanual.com>

<http://aubethermostatmanual.com>

Golf course search by state

<http://golfingnear.com>

Email search by domain

<http://emailbydomain.com>

Auto manuals search

<http://auto.somanuals.com>

TV manuals search

<http://tv.somanuals.com>