



GE Appliances

Profile™

Reverse Osmosis Filtration System

Owner's Manual

PNRV12ZBL01

Faucet & Base

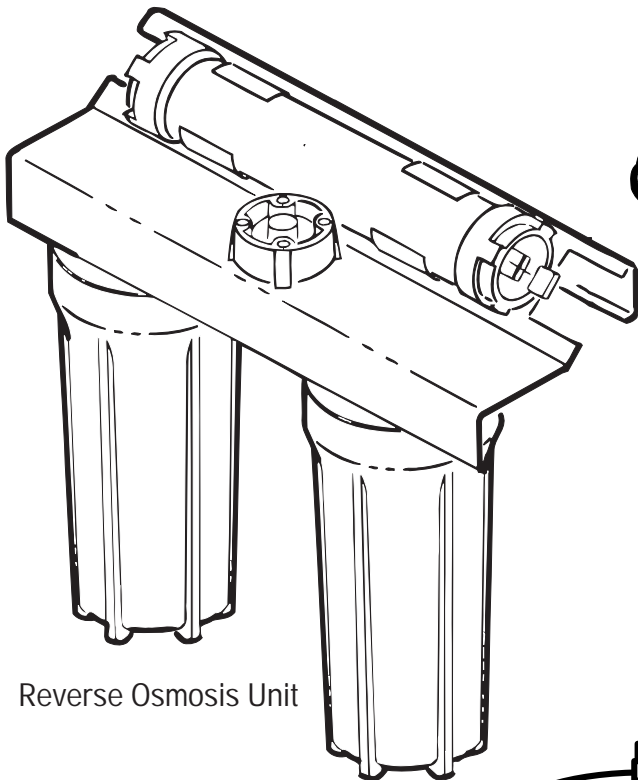
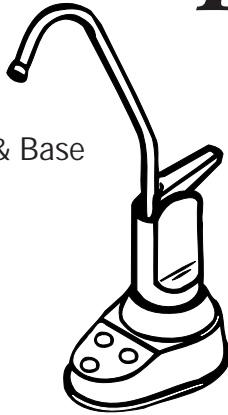

Reverse Osmosis Unit



Tested and certified to ANSI/NSF
Standard 58 for TDS and cyst reduction.

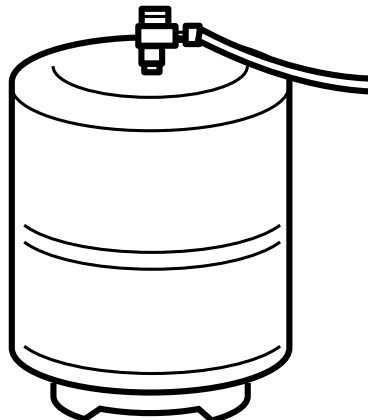

Storage Tank



Part No. 215C1002P004-4 Pub. No. 49-5802-4 5-98 CG
7178901

Operating Instructions .. 4–10
Specification Guidelines 4
Care and Cleaning of the Reverse Osmosis System 7–10
Cartridge Replacement 7
Prefilter and Postfilter Cartridge Replacement 7
Reverse Osmosis Cartridge Replacement 8
Sanitizing the Reverse Osmosis System 9
Flow Control and Screen 10
Purging the Reverse Osmosis System 10

Troubleshooting Tips
Before You Call For Service 11, 12

Customer Service
Product Registration 13, 14
Warranty 15
Service Telephone Numbers 16

Congratulations! You are Now Part of the GE Family.

Welcome to the GE family. We're proud of our quality products and we are committed to providing dependable service. You'll see it in this easy-to-use Owner's Manual and you'll hear it in the friendly voices of our customer service department.

Best of all, you'll experience these values each time you use the water system. That's important, because your new system will be part of your family for many years. And we hope you will be part of ours for a long time to come.

We thank you for buying GE. We appreciate your purchase, and hope you will continue to rely on us whenever you need quality appliances for your home.



IMPORTANT!

Fill out and return the Consumer Product Registration Card that is packed with this product. If you cannot find it, please send in the duplicate card printed in the back of this manual.



FOR YOUR RECORDS

Write the model and serial numbers here:

You can find them on the sump bracket.

Staple sales slip or cancelled check here.

Proof of the original purchase date is needed to obtain service under the warranty.

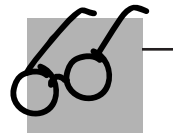

READ THIS MANUAL

Inside you will find many helpful hints on how to use and maintain your water system properly. Just a little preventive care on your part can save you a great deal of time and money over the life of your system. A video has been included with the product containing important use and care instructions.

You'll find many answers to common problems in the *Before You Call For Service* section. If you review our chart of *Troubleshooting Tips* first, you may not need to call for service at all.



IF YOU NEED SERVICE

If you do need service, you can relax knowing help is only a phone call away. A list of toll-free customer service numbers is included in the back section.

IMPORTANT SAFETY INFORMATION. READ ALL INSTRUCTIONS BEFORE USING.

⚠ WARNING! For your safety, the information in this manual must be followed to minimize the risk of property damage or personal injury.

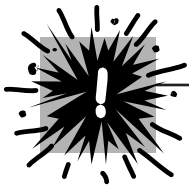

SAFETY PRECAUTIONS

- Check with your state and local public works department for plumbing and sanitation codes. You must follow these guidelines as you install the Reverse Osmosis system. *Using a qualified installer is recommended.*
 - If house water pressure is over the maximum (125 pounds per square inch), install a pressure reducing valve in the water supply line to the Reverse Osmosis system.
 - Be sure the water supply conforms with the *Specification guidelines*. If the water supply conditions are unknown, contact your municipal water company or your local health department for a list of contaminants in your area and a list of laboratories certified by your state to analyze drinking water.
- ⚠ WARNING:** Before using the Reverse Osmosis system for the first time, the system must be purged. The Reverse Osmosis cartridge contains a food grade preservative that must be purged from the system. The preservative will give product water an unpleasant taste and odor.
- This product reduces fluoride in drinking water. Please consult your dentist if you have questions.
- ⚠ WARNING:** Do not use with water that is microbiologically unsafe or of unknown quality without adequate disinfection before or after the system. Systems certified for cyst reduction may be used on disinfected water that may contain filterable cysts. This Reverse Osmosis unit contains a replaceable membrane cartridge treatment component critical for effective reduction of Total Dissolved Solids. The water should be tested periodically to verify that the system is performing satisfactorily. This system is acceptable for treatment of influent concentrations of no more than 27 mg/L nitrate and 3 mg/L nitrite in combination measured as N and is certified for nitrate/nitrite reduction only for water supplies with a pressure of 280kPa (40 psig) or greater.

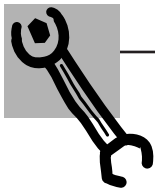

PROPER INSTALLATION AND MAINTENANCE

This Reverse Osmosis system must be properly installed and located in accordance with the Installation Instructions before it is used. If you did not receive Installation Instructions, you can receive one by calling us toll-free at the GE Answer Center®, 800.626.2000.

- Install or store where it will not be exposed to temperatures below freezing or exposed to any type of weather. Water freezing in the system will break it. Do not attempt to treat water over 100°F.
 - Do not install on **HOT WATER**. The temperature of the water supply to the Reverse Osmosis system must be between the minimum of 40°F. and the maximum of 100°F. See the *Specification guidelines*.
 - **Do Not** open the water supply valve until the pipes have been flushed.
 - **Extended non-use of the Reverse Osmosis system**
If the system is not used for one week or more, open the RO water faucet, allow the system to drain. Close the RO water faucet and allow the system to regenerate the water supply.
- ⚠ WARNING:** Discard all unused parts and packaging material after installation. Small parts remaining after the installation could be a choke hazard.
- Sanitize upon installation of the Reverse Osmosis system and after servicing inner parts, including replacement of prefilter, postfilter and Reverse Osmosis cartridge. It is important to have clean hands while handling inner parts of the system. See the *Sanitizing the Reverse Osmosis System* section.



Read and follow this Safety Information carefully.

SAVE THESE INSTRUCTIONS

Specification guidelines.

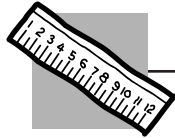

Product – height 16" width 17" depth 6"

The system makes a good supply of drinking water each day. How much it will make depends primarily on these things...

- 1 **Feed water pressure—pounds per square inch (psi)**
40–125
- 2 **Feed water temperature limits—minimum/maximum degrees F.**
40–100
- 3 **Water quality**

Maximum Total Dissolved Solids (TDS)—parts per million (ppm)
2000

Maximum water hardness @ 6.9 pH—grains per gallon (gpg)
10

For water with hardness greater than 10 grains (at 6.9 pH) the use of a softener is recommended. Failure to install a water softener will reduce the life of the Reverse Osmosis membrane. See chart for additional information on the possible need for a water softener.

Maximum iron, manganese, hydrogen sulfide (ppm)
<0.1

Chlorine in water supply
Allowable*

Feed water pH limits (pH)
4–10

Percent rejection of TDS, minimum (new membrane)**
92

*Chlorine removed (maximum of 2.0 ppm) by the Reverse Osmosis prefilter. . . regular changing of the prefilter is required. Chlorine will destroy the Reverse Osmosis membrane.

**Feed water at 50 psig and 77°F. with 750 ppm sodium chloride. Quality water production, amount of waste water and percent rejection all vary with changes in pressure, temperature and Total Dissolved Solids.

On average you should expect your Reverse Osmosis system to be able to deliver 12 gallons of product per day, as tested by Water Quality Association Standard S-300. Output according to ANSI/NSF Standard 58 is 10 gallons per day. Process water used per gallon of water produced is four gallons.

Water Softener Chart

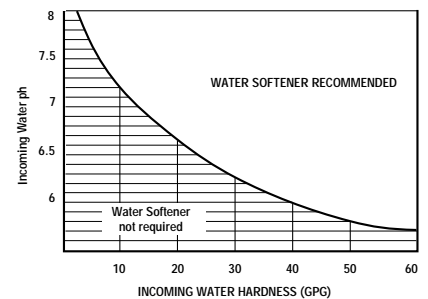

About the reverse osmosis system.

What the Reverse Osmosis System Does

Reverse Osmosis removes Total Dissolved Solids (TDS) and organic matter from water by diffusing it through a special membrane. The membrane separates minerals and impurities from the water and they are flushed to the drain. High quality product water goes directly to the drinking water faucet or to the storage tank. The system makes a good supply of drinking water each day (see *Specification guidelines*). How much it makes depends on the feed water supply pressure, temperature, and quality.

The system includes an electronic faucet assembly with an integrated water testing feature. When water is taken from the faucet, a green indicator light means TDS removal is within the specified limits, and that water quality is good.

The prefilter and postfilter are replaceable cartridges. The carbon prefilter removes chlorine while also filtering sediments. The postfilter removes any other undesirable tastes and odors before you use the water.

- 1 Prefilter**—Water from the cold supply pipe is directed to the prefilter cartridge, which is inside the sump. The prefilter is a replaceable sediment cartridge containing activated carbon. The cartridge removes sand, silt, dirt, other sediments and up to 2.0 ppm of chlorine from the feed water. The prefilter reduces chlorine in the feed water because *CHLORINE DESTROYS THE REVERSE OSMOSIS MEMBRANE*. Filtered, clean, chlorine-reduced water flows from the prefilter to the Reverse Osmosis cartridge.
- 2 Storage Tank**—The storage area holds up to 2.1 gallons of product water. A diaphragm inside the tank keeps water pressurized, when the tank is full, for fast flow to the faucet when drinking water is needed.
- 3 Check Valve**—A check valve is built into one end of the Reverse Osmosis housing under the tee fitting. The check valve prevents a backward flow of product water from the storage area. A backward flow could cause the Reverse Osmosis membrane to rupture.
- 4 Automatic Shutoff Assembly**—To conserve water, the drinking water system has an automatic shutoff. When the storage tank has filled to capacity and the drinking water faucet is closed, pressure closes the shutoff. Water flow to the Reverse Osmosis housing is shut off until drinking water is used again, and pressure drops in the Reverse Osmosis system.

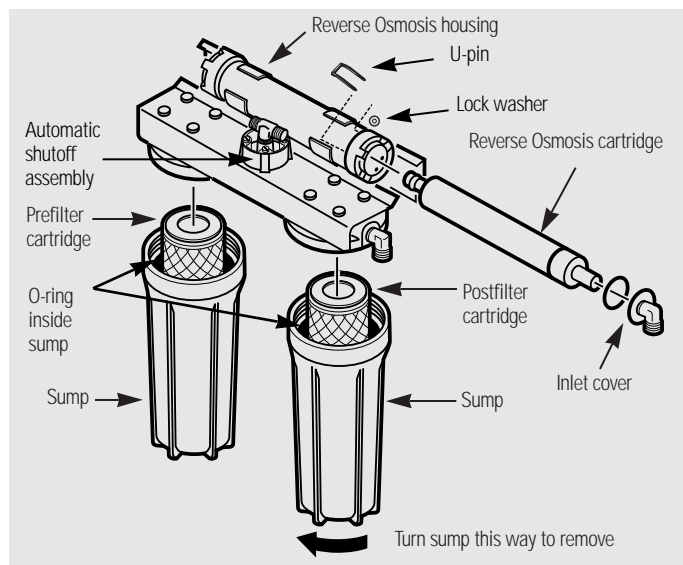

- 5 Reverse Osmosis Cartridge**—The cartridge, inside the Reverse Osmosis housing, includes a tightly wound, special membrane. Water is forced through the cartridge where the membrane removes the dissolved solids and organic matter. High quality product water exits the Reverse Osmosis housing and goes to the storage tank. Reject water, with the dissolved solids and organic matter, leaves the housing and is discharged to the drain through 1/4" tubing.
- 6 Postfilter**—After leaving the storage area, but before going to the system faucet, product water goes to the postfilter which is inside the sump. The postfilter is also a replaceable sediment cartridge that contains activated carbon. Any remaining tastes, odors, or sediments are removed from product water by the postfilter. Clean, high quality drinking water flows through the tubing and to the system faucet.
- 7 Flow Control**—The flow control regulates the flow of water through the Reverse Osmosis cartridge at the required rate to produce high quality water. The control is located in the elbow fitting at the Reverse Osmosis housing drain port. A small, cone-shaped screen fits over the front end of the flow control to prevent clogging due to sediments in the drain water.

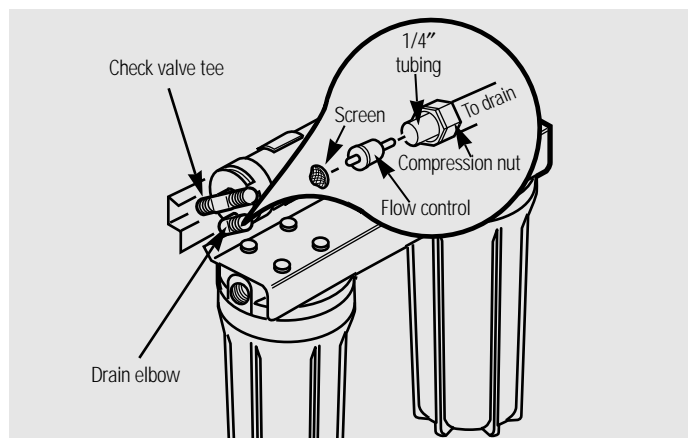

About the reverse osmosis system.

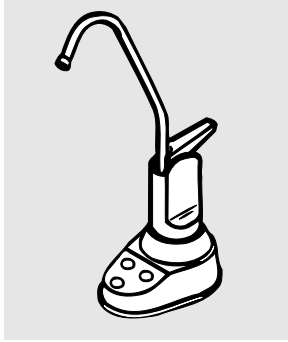

The Faucet and Indicator Lights

Faucet and Electronics—The countertop faucet dispenses filtered drinking water when opened. It has a hand-operated, spring-loaded lever to prevent waste. You can keep the faucet open by pushing upward on the lever until it locks against the faucet spout.

To comply with plumbing codes, an air gap is built into the faucet drain water connection.

The electronic faucet provides an integrated TDS monitor. As water is taken from the faucet, the indicator lights show how the Reverse Osmosis system is operating to provide high quality drinking water.

Flashing Green Light—The Reverse Osmosis system is providing high quality drinking water.

NOTE: If the Reverse Osmosis system is connected to the refrigerator this light will also flash when the icemaker or water dispenser is in use.

The green light may stop flashing when the supply of Reverse Osmosis water is nearly gone and flow from the RO water faucet decreases. This is a normal condition.

Flashing Amber “FILTER” Light—The prefilter and postfilter cartridges need replacing after six months or 900 gallons of product water. See the *Care and Cleaning* section for prefilter and postfilter cartridge replacement.

Flashing Amber “RO” Light—The Reverse Osmosis cartridge is no longer removing at least 75% of the TDS from the supply water and needs replacing. See the *Care and Cleaning* section for Reverse Osmosis cartridge replacement.

NOTE: Disregard initial or short periods (a few seconds) of the flashing “RO” light. Long periods of limited or non use can cause the TDS levels to temporarily change.

Care and cleaning of the reverse osmosis system.

To obtain replacement filters, call GE Appliance Parts at 800-626-2002.

<i>Prefilter/Postfilter Cartridge Replacement FX12P</i>	<i>Activated Carbon</i>
<i>Reverse Osmosis Cartridge Replacement FX12M</i>	<i>Thin Film Polyamide</i>

If the Reverse Osmosis filtration system is connected to your icemaker, *YOU MUST* turn off the icemaker by raising the feeler arm before servicing or changing the filters, or when purging the Reverse Osmosis system. Four hours after servicing, lower the feeler arm to resume icemaking.

When replacing cartridges you may lift the Reverse Osmosis assembly from the mounting washers and lay it on the floor. You can also remove the Reverse Osmosis housing by pulling it out of the mounting clamps.

▲ CAUTION: Before servicing the Reverse Osmosis system, close the shutoff valve on the storage tank, close the water supply/saddle valve and open the RO water faucet. Allow the system to drain.

Prefilter and Postfilter Cartridge Replacement

When the amber “FILTER” light flashes the prefilter and postfilter cartridges must be replaced. The batteries in the control box must also be replaced.

- 1 Follow the steps in the *Sanitizing the Reverse Osmosis System* section except discard the old filters and replace with new filters.
- 2 Replace the “AA” alkaline batteries in the control box. Good batteries are needed to ensure proper indicator light operation. **NOTE:** Lights may not operate properly until system has been allowed to refill the storage tank. Weak batteries may give a false indication. Changing the batteries resets the six month or 900 gallon period.

Care and cleaning of the reverse osmosis system.

Reverse Osmosis Cartridge Replacement

NOTE: When replacing the Reverse Osmosis cartridge, also install a new flow control and screen. See the Flow Control and Screen section.

If the Reverse Osmosis Filtration system is connected to your icemaker YOU MUST turn off the icemaker by raising the feeler arm before servicing the filter, changing the filters, or purging the filtration system. Four hours after servicing your unit, lower the feeler arm to resume icemaking.

When replacing cartridges you may lift the Reverse Osmosis assembly from the mounting washers and lay it on the floor. You can also remove the Reverse Osmosis housing by pulling it out of the mounting clamps.

When the amber "RO" light flashes the Reverse Osmosis cartridge must be replaced. **NOTE:** Disregard initial or short periods (a few seconds) of the flashing "RO" light. Long periods of limited or non use can cause TDS levels to temporarily change.

Be sure you clean your hands with anti-bacterial soap before handling inner parts of the system.

1 Be sure the water supply valve to the Reverse Osmosis system is turned off, and the RO water faucet and storage tank are open. Allow the system to drain completely (this takes several minutes).

2 Pull the Reverse Osmosis system out away from cabinet. Leave tubing connected. Place a dry towel under the Reverse Osmosis unit. Using pliers remove the lock washer, pull the u-pin and remove the Reverse Osmosis housing inlet cover. Save the lock washer for final assembly.

▲ CAUTION: Failure to close the water supply valve or tank shutoff valve will cause water to spray or run when sumps are removed.

3 Remove the lock washer, pull the u-pin and remove the inlet cover from the housing.

4 Use pliers to pull the cartridge from the housing and discard the cartridge.

5 Sanitize the system. Go to the *Sanitizing the Reverse Osmosis System* section and follow steps 4 through 11.

6 Install new flow control and screen. Go to the *Flow Control and Screen* section for directions.

7 Pull the u-pin and remove the inlet cover from the housing.

8 Install the new Reverse Osmosis cartridge. **NOTE:** The Reverse Osmosis cartridge o-ring end is notched and may need to be rotated during reinstallation for proper fit.

9 Replace the inlet cover. Lightly lubricate the o-ring seal with only clean silicone grease.

10 Insert the u-pin and install the lock washer.

11 Turn on the water supply. Check for leaks.

12 Purge the Reverse Osmosis system. Go to the *Purging the Reverse Osmosis System* section.

▲ CAUTION: The Reverse Osmosis cartridge contains a food grade preservative that should be purged from the system before first use or whenever the Reverse Osmosis cartridge is replaced. The preservative will give product water an unpleasant taste and odor. After the tank has filled (takes about four hours), open the system faucet until the bladder is empty. After four of these drainings, the system is ready to make product water for your use.

NOTE: Lights may not operate properly until the system has been allowed to refill the tank.

Sanitizing the Reverse Osmosis System

Sanitize upon installation of the Reverse Osmosis system and after servicing inner parts, including replacement of prefilter, postfilter and the Reverse Osmosis cartridge. **Be sure you clean your hands with anti-bacterial soap before handling inner parts of the system.**

▲ CAUTION: Before sanitizing, be sure to remove all cartridges as follows. **Chlorine will destroy the Reverse Osmosis cartridge.**

1 Be sure the water supply valve to the Reverse Osmosis system is turned off, and the RO water faucet and storage tank are open. Allow the system to drain completely (this takes several minutes).

2 Pull the Reverse Osmosis system out away from cabinet. Leave tubing connected. Place a dry towel under the Reverse Osmosis unit. Using pliers remove the lock washer, pull the u-pin clip and remove the Reverse Osmosis housing inlet cover. Save the lock washer for final assembly.

3 Remove (using pliers) the Reverse Osmosis cartridge from the housing. Place the cartridge in a clean plastic bag.

4 Replace the inlet cover and u-pin, making sure the o-ring is in place.

5 Remove the POSTFILTER sump by turning it to the left using the sump wrench tool provided. Be careful, the sump is full of water. Remove the cartridge from the sump and place in a clean plastic bag. Make sure the o-ring is seated in the top of the sump. With the o-ring seal in position, replace the sump and tighten securely by hand.

6 Remove the PREFILTER sump and cartridge. Place this cartridge in a clean plastic bag.

7 Fill the prefilter sump with cold water to about 1" from the o-ring. Add 1 ounce (2 tablespoons) of ordinary 5.25% household chlorine bleach and mix into the water. **Do not add chlorine first. Concentrated chlorine may damage plastic.**

8 Carefully replace the sump (make sure the o-ring valve seal is in place) on the prefilter head and tighten securely by hand.

9 Close the RO water faucet. Open the water supply valve (turn counterclockwise) to the Reverse Osmosis system. Allow system to fill for one minute.

10 Open the RO water faucet and allow water to flow for 10 minutes through the Reverse Osmosis system. Close RO water faucet for one minute and then open faucet and allow water to flow (approximately 10 minutes) until bleach odor is gone.

11 Turn off the water supply valve (turn clockwise) to the Reverse Osmosis system. After water flow stops, leave the RO water faucet open.

12 **Be sure hands have been cleaned with anti-bacterial soap.** Repeat steps 1–6 and 8; however, reinstall the cartridges instead of removing them.

NOTE: The Reverse Osmosis cartridge o-ring end is notched and may need to be rotated during reinstallation for proper fit.

13 After installing/reinstalling cartridges, close RO water faucet and open water supply valve (turn counterclockwise). Check for leaks.

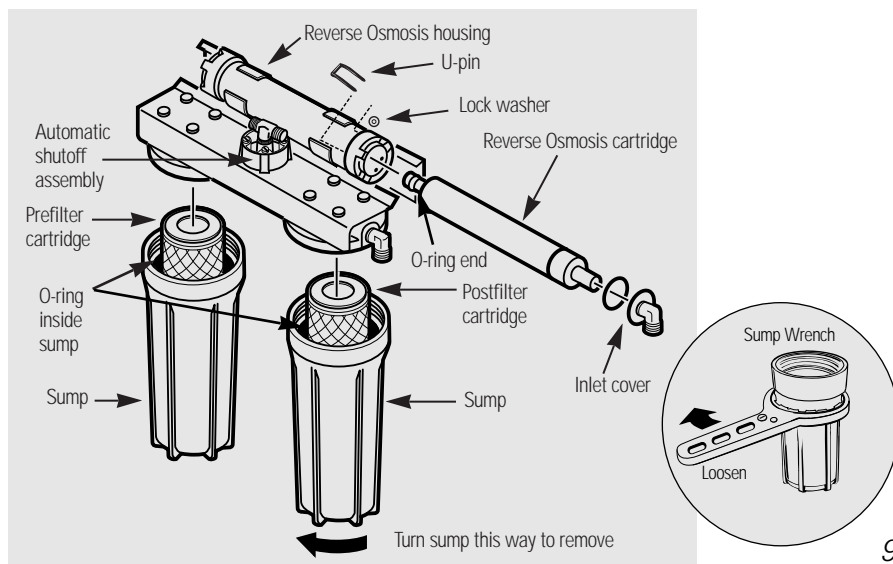

Care and cleaning of the reverse osmosis system

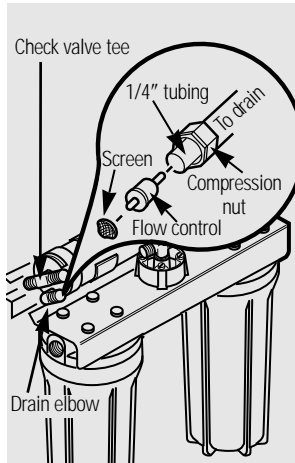

Flow Control and Screen

The flow control regulates the flow of water through the Reverse Osmosis cartridge at the required rate so high quality product water is produced.

When servicing the Reverse Osmosis cartridge, check the flow control and tubing, to make sure the tube and surrounding surfaces are clean and unrestricted. A small, cone-shaped screen is located in front of the flow control to help keep it clean. If the flow control is plugged with foreign particles, the Reverse Osmosis cartridge cannot discharge minerals and impurities to the drain. If this happens, it will only take a short time for the system to plug.

1. Make sure tank shutoff valve is closed, water supply valve is closed (turn clockwise), and the RO water faucet is open. Drain system until water stops flowing.
2. Locate the plastic drain elbow, next to the brass check valve tee.
3. Unscrew the compression nut.
4. Remove flow control with a clean knife edge. Remove screen; a toothpick may be needed.

5. If you are replacing the flow control and screen, discard them. If you are checking the flow control, screen and tubing for blockage, clean these parts of any debris. Do not blow through the flow control, it will contaminate the part.
 6. Replace the screen by placing the cone end into the elbow cap and carefully push it in.
- CAUTION:** Do not force in further after you feel resistance. Visually check to be sure it is properly positioned.
7. Install flow control and tighten compression nut by hand, then another 1/4 turn with pliers. **DO NOT OVERTIGHTEN AND DISTORT OR CRUSH THE TUBING AND FLOW CONTROL.**
 8. If you are replacing the Reverse Osmosis cartridge, return to the *Reverse Osmosis Cartridge Replacement* instructions. Otherwise, open the tank valve and the water supply valve (turn counterclockwise). Close the RO water faucet.

Purging the Reverse Osmosis System

The Reverse Osmosis system **MUST BE PURGED AFTER INSTALLATION** and **WHEN THE REVERSE OSMOSIS CARTRIDGE IS REPLACED**.

1. Make sure all tubing connections are tightened.
 2. Make sure the tank shutoff valve is open. Turn on the water supply by slowly opening the water supply valve (turn counterclockwise) to the Reverse Osmosis system. Carefully check system for leaks.
 3. Wait approximately four hours for storage tank to fill. *At that time*, carefully check all fittings and tubing connections again for any water leaks.
 4. Open the RO water faucet until the tank is empty and flow stops.
 5. After filling and emptying the storage tank four times, the system is ready to make product water for your use.
- WARNING:** The Reverse Osmosis cartridge contains a food grade preservative that should be purged from the system before use. The preservative will give product water an unpleasant taste and odor.

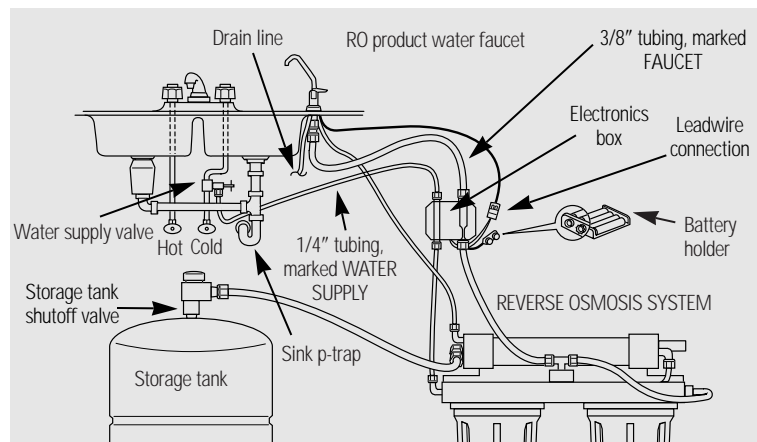

Before you call for service...



Troubleshooting Tips
 Save time and money! Review the charts on the following pages first and you may not need to call for service.

Problem	Possible Causes	What To Do
Sounds you might hear	Running water from the unit to a drain.	<ul style="list-style-type: none"> • This is normal.
Water has air bubbles and is cloudy	Air in system after installation.	<ul style="list-style-type: none"> • Will go away after water runs for a while.
Amber "FILTER" light on the faucet base is flashing	Six months or 900 gallons of product water usage has occurred.	<ul style="list-style-type: none"> • Replace the prefilter, postfilter, and batteries in the electronics box.
Amber "RO" light flashing. NOTE: Disregard initial or occasional short periods of this flashing light.	Low usage of the Reverse Osmosis product water	<ul style="list-style-type: none"> • Open the RO water faucet and allow the system to drain. Close the RO water faucet and allow the system to regenerate the water supply.
	The Reverse Osmosis cartridge is no longer removing the required amount of Total Dissolved Solids.	<ul style="list-style-type: none"> • Replace the Reverse Osmosis cartridge, flow control and screen.
	Water supply to the Reverse Osmosis system not within specifications.	<ul style="list-style-type: none"> • Increase water pressure, precondition the water, etc., as needed to conform before doing maintenance on the Reverse Osmosis system.
Indicator lights on faucet base not working	Faucet base leadwire not connected to electronics box leadwire.	<ul style="list-style-type: none"> • Connect.
	Battery pack not connected to electronics box.	<ul style="list-style-type: none"> • Connect.
	Batteries installed incorrectly.	<ul style="list-style-type: none"> • Make sure batteries are installed correctly.
	Batteries are weak.	<ul style="list-style-type: none"> • Replace batteries.
	Leadwires damaged.	<ul style="list-style-type: none"> • Inspect and repair as needed.

Before you call for service...

<i>Problem</i>	<i>Possible Causes</i>	<i>What To Do</i>
<i>Chlorine taste and/or odor in the Reverse Osmosis product water</i>	The ppm of chlorine in your water supply exceeds maximum limits and has destroyed the Reverse Osmosis membrane.	<ul style="list-style-type: none"> If the water supply contains more than 2.0 ppm of chlorine, additional filtering of the water supply to the Reverse Osmosis is needed. Correct this condition before doing maintenance on the Reverse Osmosis system.
	The prefilter is no longer removing chlorine from the water supply.	<ul style="list-style-type: none"> Replace the Reverse Osmosis membrane cartridge, control, screen, prefilter, postfilter and batteries in the electronics box.

<i>Other taste and/or odor</i>	High quality product water may have a different taste than what you're used to.	<ul style="list-style-type: none"> This is normal.
	Low water usage	<ul style="list-style-type: none"> Completely drain system and allow to refill.
	Contamination in product water storage.	<ul style="list-style-type: none"> Use sanitizing procedures.
	Prefilter and postfilter need to be changed.	<ul style="list-style-type: none"> Replace the prefilter and postfilter.

<i>Water leaking from faucet air gap hole</i>	Drain side of faucet air gap (3/8" tubing) plugged, restricted or incorrectly connected to the drain point.	<ul style="list-style-type: none"> Inspect and eliminate restriction or plug. It is important that there are no dips, loops or low spots in the drain line from the faucet air gap to the drain pipe. Refer to Installation Instructions for proper drain connection. If drain line adapter was used as the drain point, periodic inspection/cleaning is recommended.
---	--	--

<i>System makes product water slowly</i>	This is normal.	<ul style="list-style-type: none"> Water flow rate will be lower than your regular faucet.
	Water supply to the Reverse Osmosis system not within specifications.	<ul style="list-style-type: none"> Increase water pressure, precondition the water, etc., as needed to conform before doing maintenance on the Reverse Osmosis system.
	Prefilter cartridge plugged with sediments and/or the Reverse Osmosis cartridge plugged with sediments.	<ul style="list-style-type: none"> Replace the prefilter. If rate does not increase, replace the postfilter, Reverse Osmosis cartridge, flow control, screen and batteries in the electronics box.

GE Service Protection Plus™

GE, a name recognized worldwide for quality and dependability, offers you Service Protection Plus™—comprehensive protection on all your appliances—**No Matter What Brand!**

Benefits Include:

- **Backed by GE**
- **All brands covered**
- **Unlimited service calls**
- **All parts and labor costs included**
- **No out-of-pocket expenses**
- **No hidden deductibles**
- **One 800 number to call**

***We'll Cover Any Appliance.
Anywhere. Anytime.****

You will be completely satisfied with our service protection or you may request your money back on the remaining value of your contract. No questions asked. It's that simple.

Protect your refrigerator, dishwasher, washer and dryer, range, TV, VCR and much more—**any brand!** Plus there's no extra charge for emergency service and low monthly financing is available. Even icemaker coverage and food spoilage protection is offered. You can rest easy knowing that all your valuable household products are protected against expensive repairs.

Place your confidence in GE and call us in the U.S. toll-free at **800-626-2224** for more information.

*All brands covered, up to 20 years old, in the continental U.S.

 Cut here

Please place in envelope and mail to:

General Electric Company
Warranty Registration Department
P.O. Box 34070
Louisville, KY 40232-4070

GE Reverse Osmosis System Warranty



All warranty service provided by our Factory Service Centers, or an authorized Customer Care[®] technician. For service, call 800-GE-CARES.

For The Period Of: **GE Will Replace, At No Charge To You:**

One Year
From the date of the original purchase

Any part of the Reverse Osmosis Filtration System which fails due to a defect in materials or workmanship. During this **full one-year warranty**, GE will also provide, **free of charge**, all labor and in-home service to replace the defective part.

What GE Will Not Cover:

- Service trips to your home to teach you how to use the product.
- Improper installation.
- Failure of the product if it is abused, misused, or used for other than the intended purpose or used commercially.
- Filters, membranes or batteries.
- Replacement of house fuses or resetting of circuit breakers.
- Damage to the product caused by accident, fire, floods or acts of God.
- Incidental or consequential damage to personal property caused by possible defects with this appliance.

This warranty is extended to the original purchaser and any succeeding owner for products purchased for home use within the USA. In Alaska, the warranty excludes the cost of shipping or service calls to your home.

Some states do not allow the exclusion or limitation of incidental or consequential damages. This warranty gives you specific legal rights, and you may also have other rights which vary from state to state. To know what your legal rights are, consult your local or state consumer affairs office or your state's Attorney General.

Warrantor: General Electric Company, Louisville, KY 40225



GE Answer Center® 800.626.2000

The GE Answer Center® is open 24 hours a day, 7 days a week.



In-Home Repair Service 800-GE-CARES (800-432-2737)

Expert GE repair service is only a phone call away.

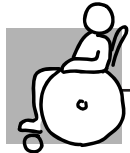

Special Needs Service 800.626.2000

800-TDD-GEAC (800-833-4322)

GE offers, free of charge, a brochure to assist in planning a barrier-free kitchen for persons with limited mobility.



Service Contracts 800-626-2224

Purchase a GE service contract while your warranty is still in effect and you'll receive a substantial discount. GE Consumer Service will still be there after your warranty expires.

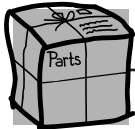

Parts and Accessories 800-626-2002

Individuals qualified to service their own appliances can have parts or accessories sent directly to their homes (VISA, MasterCard and Discover cards are accepted).

Instructions contained in this manual cover procedures to be performed by any user. Other servicing generally should be referred to qualified service personnel. Caution must be exercised, since improper servicing may cause unsafe operation.



Service Satisfaction

If you are not satisfied with the service you receive from GE:

First, contact the people who serviced your appliance.

Next, if you are still not pleased, write all the details—including your phone number—to:

Manager, Consumer Relations
 GE Appliances
 Appliance Park
 Louisville, KY 40225

Finally, if your problem is still not resolved, write:

Major Appliance Consumer Action Program
 20 North Wacker Drive
 Chicago, IL 60606

Free Manuals Download Website

<http://myh66.com>

<http://usermanuals.us>

<http://www.somanuals.com>

<http://www.4manuals.cc>

<http://www.manual-lib.com>

<http://www.404manual.com>

<http://www.luxmanual.com>

<http://aubethermostatmanual.com>

Golf course search by state

<http://golfingnear.com>

Email search by domain

<http://emailbydomain.com>

Auto manuals search

<http://auto.somanuals.com>

TV manuals search

<http://tv.somanuals.com>