

ULTRA SOURCE

Commercial, Industrial, Residential
Portable Generator

Owner's Manual

- Safety
- Assembly
- Operation
- Maintenance
- Troubleshooting
- Electrical Data
- Parts
- Warranty



**2 YEAR
LIMITED
WARRANTY**



MODELS:
004451 (12,500 Watt)
004582 (15,000 Watt)

FOR YOUR NEAREST AUTHORIZED SERVICE CENTER 1-800-333-1322

Safety Rules1-3

Section 1 – General Information4

1.1 Unpacking4
 1.1.1 Accessory Box4
 1.2 Assembly4
 1.2.1 Assembling the Wheel Kit4
 1.2.2 Assembling the Handle5
 1.2.3 Battery Connection.....5

Section 2 – Operation6

2.1 Know The Generator6
 2.2 Cord Sets and Connector Plugs7
 2.2.1 120V AC, 20 A, Duplex Receptacle7
 2.2.2 120V AC, 20 A, GFCI Receptacle7
 2.2.3 120V AC, 30 A Receptacle7-8
 2.2.4 120/240V AC, 30 A, Receptacle8
 2.2.5 12 VDC, 10 Amp Receptacle8
 2.2.6 120/240V AC, 50 A, Receptacle8
 2.3 How To Use The Generator9
 2.3.1 Grounding The Generator9
 2.3.2 Connecting Electric Loads9
 2.4 Don't Overload The Generator9
 2.5 Wattage Reference Chart10
 2.6 Before Starting The Generator.....10
 2.6.1 Adding Engine Oil10
 2.6.2 Adding Gasoline11
 2.7 To Start The Engine11
 2.8 Stopping The Engine12
 2.9 Automatic Idle Control12
 2.10 Cold Weather Operation/De-Icer12
 2.11 Low Oil Pressure Shutdown.....12
 2.11.1 Initial Start-up.....12
 2.11.2 Sensing Low Oil Pressure12
 2.11.3 Restarting.....12
 2.12 Charging a Battery.....13

Section 3 – Maintenance.....14

3.1 Maintenance Schedule.....14
 3.2 Product Specifications14
 3.2.1 Generator Specifications14
 3.2.2 Engine Specifications14
 3.3 General Recommendations15
 3.3.1 General Maintenance.....15
 3.3.2 To Clean The Generator.....15
 3.3.3 Engine Maintenance.....15
 3.3.4 Checking Oil Level15
 3.3.5 Changing The Oil & Oil Filter15
 3.3.6 Replacing The Spark Plug15-16
 3.4 Service Air Cleaner16
 3.5 Clean Spark Arrestor Screen16
 3.6 Adjusting Valve Clearance17
 3.7 General18
 3.8 Long Term Storage.....18
 3.9 Other Storage Tips.....18

Section 4 – Troubleshooting.....19

4.1 Troubleshooting Guide19

Section 5 – Notes20-21

Section 6 – Electrical Data22-23

**Section 7 – Exploded Views and
Parts Lists.....24-33**

Section 8 – Warranty34-36

INTRODUCTION

Thank you for purchasing this model of the GUARDIAN® product line by Generac Power Systems, Inc. This model is a compact, high performance, air-cooled, engine driven generator designed to supply electrical power to operate electrical loads where no utility power is available.

READ THIS MANUAL THOROUGHLY

If you do not understand any portion of this manual, contact your nearest GENERAC/GUARDIAN® Authorized Dealer for starting, operating and servicing procedures.

Throughout this publication, and on tags and decals affixed to the generator, DANGER, WARNING, CAUTION and NOTE blocks are used to alert you to special instruction about a particular operation that may be hazardous if performed incorrectly or carelessly. Observe them carefully. Their definitions are as follows:

----- ⚠ DANGER ⚠ -----

After this heading, you can read instructions that, if not strictly complied with, will result in personal injury or property damage.

----- ⚠ WARNING ⚠ -----

After this heading, you can read instructions that, if not strictly complied with, may result in personal injury or property damage.

----- ⚠ CAUTION ⚠ -----

After this heading, you can read instructions that, if not strictly complied with, could result in damage to equipment and/or property.

NOTE: After this heading, you can read explanatory statements that require special emphasis. These safety warnings cannot eliminate the hazards that they indicate. Common sense and strict compliance with the special instructions while performing the service are essential to preventing accidents.

Four commonly used safety symbols accompany the **DANGER**, **WARNING** and **CAUTION** blocks. The type of information each indicates follows:

⚠ This symbol points out important safety information that, if not followed, could endanger personal safety and/or property of you and others.

⚠ This symbol points out potential explosion hazard.

⚠ This symbol points out potential fire hazard.

⚠ This symbol points out potential electrical shock hazard.

The operator is responsible for proper and safe use of the equipment. We strongly recommend that the operator read this *Owner's Manual* and thoroughly

understand all instructions before using this equipment. We also strongly recommend instructing other users to properly start and operate the unit. This prepares them if they need to operate the equipment in an emergency.

CAUTION! Always disconnect spark plug wire and place the wire where it cannot contact the spark plug to prevent accidental starting when setting up, transporting, adjusting or making repairs to your generator.

- The generator produces dangerously high voltage that can cause extremely hazardous electrical shock. Avoid contact with bare wires, terminals, etc. Never permit any unqualified person to operate or service the generator.
- Never handle any kind of electrical cord or device while standing in water, while barefoot or while hands or feet are wet. Dangerous electrical shock will result.
- The National Electric Code requires the frame and external electrically conductive parts of the generator be properly connected to an approved earth ground. Local electrical codes may also require proper grounding of the generator. Consult with a local electrician for grounding requirements in your area.
- Use a ground fault circuit interrupter in any damp or highly conductive area (such as metal decking or steel work).
- Do not use worn, bare, frayed or otherwise damaged electrical cord sets with the generator.
- Operate generator only on level surfaces and where it will not be exposed to excessive moisture, dirt, dust or corrosive vapors.
- Gasoline is highly **FLAMMABLE** and its vapors are **EXPLOSIVE**. Do not permit smoking, open flames, sparks or heat in the vicinity while handling gasoline. Avoid spilling gasoline on a hot engine. Comply with all laws regulating storage and handling of gasoline.
- Never add fuel while unit is running.
- Do not overfill the fuel tank. Always allow room for fuel expansion. If tank is overfilled, fuel can overflow onto a hot engine and cause **FIRE** or an **EXPLOSION**.
- Never store generator with fuel in tank where gasoline vapors might reach an open flame, spark or pilot light (as on a furnace, water heater or clothes dryer). **FIRE** or **EXPLOSION** may result.
- Generator exhaust gases contain **DEADLY** carbon monoxide gas. This dangerous gas, if breathed in sufficient concentrations, can cause unconsciousness or even death. Operate this equipment only in the open air where adequate ventilation is available.
- Allow at least 2 feet of clearance on all sides of generator or you could damage the unit. Never operate the unit inside any room or enclosure where the free flow of cooling air into and out of the unit might be obstructed. Review "Cold Weather Operation" on page 12.



IMPORTANT SAFETY INSTRUCTIONS

Commercial-Industrial-Residential Portable Generator System

⚠ SAVE THESE INSTRUCTIONS – *The manufacturer suggests that these rules for safe operation be copied and posted near the unit's installation site. Safety should be stressed to all operators and potential operators of this equipment.*

- Never start or stop the unit with electrical loads connected to receptacles AND with connected devices turned ON. Start the engine and let it stabilize before connecting electrical loads. Disconnect all electrical loads before shutting down the generator.
- Do not insert objects through unit's cooling slots.
- **Never operate generator:** in rain; in any enclosed compartment; if connected electrical devices overheat; if electrical output is lost; if engine or generator sparks; if flames or smoke are observed while unit is running; if unit vibrates excessively.

Note: Your generator is equipped with a spark arrestor muffler. The spark arrestor must be maintained in effective working order by the owner/ operator. In the State of California, a spark arrestor is required by law (Section 4442 of the California Public Resources Code). Other states may have similar laws. Federal laws apply on federal lands.

Study these **SAFETY RULES** carefully before installing, operating or servicing this equipment. Become familiar with this *Owner's Manual* and with the unit. The generator can operate safely, efficiently and reliably only if it is properly installed, operated and maintained. Many accidents are caused by failing to follow simple and fundamental rules or precautions.

GENERAC® cannot possibly anticipate every possible circumstance that might involve a hazard. The warnings in this



WARNING:



The engine exhaust from this product contains chemicals known to the state of California to cause cancer, birth defects or other reproductive harm.



WARNING:



This product contains or emits chemicals known to the state of California to cause cancer, birth defects or other reproductive harm.

manual, and on tags and decals affixed to the unit are, therefore, not all-inclusive. If you use a procedure, work method or operating technique GENERAC® does not specifically recommend, you must satisfy yourself that it is safe for you and others. You also must make sure the procedure, work method or operating technique that you choose does not render the generator unsafe.

----- ⚠ DANGER ⚠ -----

Despite the safe design of this generator, operating this equipment imprudently, neglecting its maintenance or being careless can cause possible injury or death. Permit only responsible and capable persons to operate or maintain this equipment.

⚠ Potentially lethal voltages are generated by these machines. Ensure all steps are taken to render the machine safe before attempting to work on the generator.

⚠ Parts of the generator are rotating and/or hot during operation. Exercise care near running generators.

⚠ GENERAL HAZARDS ⚠

- For safety reasons, GENERAC® recommends that the installation, initial start-up and maintenance of this equipment is carried out by a GENERAC®/GUARDIAN® Authorized Dealer.
- The engine exhaust fumes contain carbon monoxide, which can be **DEADLY**. This dangerous gas, if breathed in sufficient concentrations, can cause unconsciousness or even death. This exhaust system must be installed properly, in strict compliance with applicable codes and standards. Following installation, you must do nothing that might render the system unsafe or in noncompliance with such codes and standards.
- Keep hands, feet, clothing, etc., away from drive belts, fans, and other moving or hot parts. Never remove any drive belt or fan guard while the unit is operating.
- Adequate, unobstructed flow of cooling and ventilating air is critical to correct generator operation. Do not alter the installation or permit even partial blockage of ventilation provisions, as this can seriously affect safe operation of the generator. The generator **MUST** be operated outdoors.
- When working on this equipment, remain alert at all times. Never work on the equipment when you are physically or mentally fatigued.
- Inspect the generator regularly, and contact your nearest GENERAC®/GUARDIAN® Authorized Dealer for parts needing repair or replacement.
- Before performing any maintenance on the generator, disconnect its battery cables to prevent accidental start up. Disconnect the cable from the battery post indicated by a **NEGATIVE**, **NEG** or **(-)** first. Reconnect that cable last.
- Never use the generator or any of its parts as a step. Stepping on the unit can stress and break parts, and may result in dangerous operating conditions from leaking exhaust gases, fuel leakage, oil leakage, etc.



⚠ ELECTRICAL HAZARDS ⚠

- All generators covered by this manual produce dangerous electrical voltages and can cause fatal electrical shock. Utility power delivers extremely high and dangerous voltages as does the generator when it is in operation. Avoid contact with bare wires, terminals, connections, etc., while the unit is running. Ensure all appropriate covers, guards and barriers are in place before operating the generator. If you must work around an operating unit, stand on an insulated, dry surface to reduce shock hazard.
- Do not handle any kind of electrical device while standing in water, while barefoot, or while hands or feet are wet. **DANGEROUS ELECTRICAL SHOCK MAY RESULT.**
- The National Electrical Code (NEC) requires the frame and external electrically conductive parts of the generator to be connected to an approved earth ground. Local electrical codes also may require proper grounding of the generator electrical system.
- In case of accident caused by electric shock, immediately shut down the source of electrical power. If this is not possible, attempt to free the victim from the live conductor. **AVOID DIRECT CONTACT WITH THE VICTIM.** Use a non-conducting implement, such as a rope or board, to free the victim from the live conductor. If the victim is unconscious, apply first aid and get immediate medical help.
- Never wear jewelry when working on this equipment. Jewelry can conduct electricity resulting in electric shock, or may get caught in moving components causing injury.

⚠ FIRE HAZARDS ⚠

- For fire safety, the generator must be operated and maintained properly. Operation always must comply with applicable codes, standards, laws and regulations. Adhere strictly to local, state and national electrical and building codes. Comply with regulations the Occupational Safety and Health Administration (OSHA) has established. Also, ensure that the generator is operated in accordance with the manufacturer's instructions and recommendations. Do not alter the construction of generator or change controls which might create an unsafe operating condition.
- Keep a fire extinguisher near the generator at all times. Extinguishers rated "ABC" by the National Fire Protection Association are appropriate for use on the standby electric system. Keep the extinguisher properly charged and be familiar with its use. If you have any question pertaining to fire extinguishers, consult your local fire department.

⚠ EXPLOSION HAZARDS ⚠

- Do not smoke around the generator. Wipe up any fuel or oil spills immediately. Ensure that no combustible materials are left on or near the generator, as FIRE or EXPLOSION may result. Keep the area surrounding the generator clean and free from debris.
- Gasoline is extremely **EXPLOSIVE.**

STANDARDS INDEX

In the absence of pertinent standards, codes, regulations and laws, the published information listed below may be used as a guideline for operation of this equipment.

1. NFPA No. 70, NFPA HANDBOOK OF NATIONAL ELECTRIC CODE.
2. Article X, NATIONAL BUILDING CODE, available from the American Insurance Association, 85 John Street, New York, N.Y. 10038.
3. AGRICULTURAL WIRING HANDBOOK, available from the Food and Energy Council, 909 University Avenue, Columbia, MO 65201.
4. ASAE EP-3634, INSTALLATION AND MAINTENANCE OF FARM STANDBY ELECTRICAL SYSTEMS, available from the American Society of Agricultural Engineers, 2950 Niles Road, St. Joseph, MI 49085.
5. NFPA No. 30, FLAMMABLE AND COMBUSTIBLE LIQUIDS CODE.

1.1 UNPACKING

- Set the palletted carton on a rigid flat surface.
- Remove staples along bottom of carton that fasten carton to pallet. Open carton from top.
- Remove all packaging material.
- Remove separate accessory box.
- Lift carton off the generator.
- Remove generator from shipping pallet by removing bolts through the shipping brackets.

Figure 1 - Bracket Removal



1.1.1 ACCESSORY BOX

Check all contents. If any parts are missing or damaged locate an authorized dealer at 1-800-333-1322.

Contents include:

- Owner's Manual
- Bolt-on tubular handle
- Wheel Axle
- 2 – Pneumatic Wheels
- 2 – Axle Bracket Assemblies
- 2 – Washers
- 2 – Wheel Spacers
- 2 – Cotter Pins
- Bolt-on Foot
- 6 – Carriage Bolts, Washers, Nuts
- Battery Charge Cable
- Spark Plug Wrench
- 2 Spark Plugs.
- Air Filter
- Pre-cleaner

1.2 ASSEMBLY

The generator requires some assembly prior to using it. If problems arise when assembling the generator, please call the Generator Helpline at 1-800-333-1322.

1.2.1 ASSEMBLING THE WHEEL KIT

The wheel kit is designed to greatly improve the portability of the generator. A socket wrench with a 9/16" socket, a 1/2" socket, a 1/2" wrench and a pair of pliers are the tools that will be needed for assembly of the wheel kit.

Note:The wheel kit is not intended for over-the-road use.

- Refer to *Figure 2* shown on opposite page and install the wheel kit as follows:
- Place the generator on a hard flat surface.
- Stand at the engine end of the unit and gently tilt the generator forward, high enough to place wooden blocks beneath the cradle. This will allow space to install the wheel assemblies.
- Attach an axle bracket assembly with attached sleeve to either side of the frame. Ensure the sleeve faces outward.
- Slide the axle through the sleeves on the axle brackets.
- Slide one wheel with flat washer to the outside and a spacer to the inside onto each end of the axle. Make sure the air inflation valve on the wheel is facing outward.
- Insert retaining pins and using pliers, bend out the ends to prevent the pins from falling out of the axle. Remove the wooden blocks.

1.2.2 ASSEMBLING THE HANDLE

- Attach the handle by aligning one side of the handle on the cradle, then spread the handle around the cradle and let it spring into place. Secure the handle to the frame using the 5/16" hex head bolts provided. Check each fastener to ensure that it is secure.
- Using the handle, lift the unit high enough to place wooden blocks under the unit. Attach the front support foot to the underside of the cradle using the 3/8" carriage bolts provided.
- Remove the shipping brackets from the cradle, if not already done so.

Figure 2 - Handle Assembly

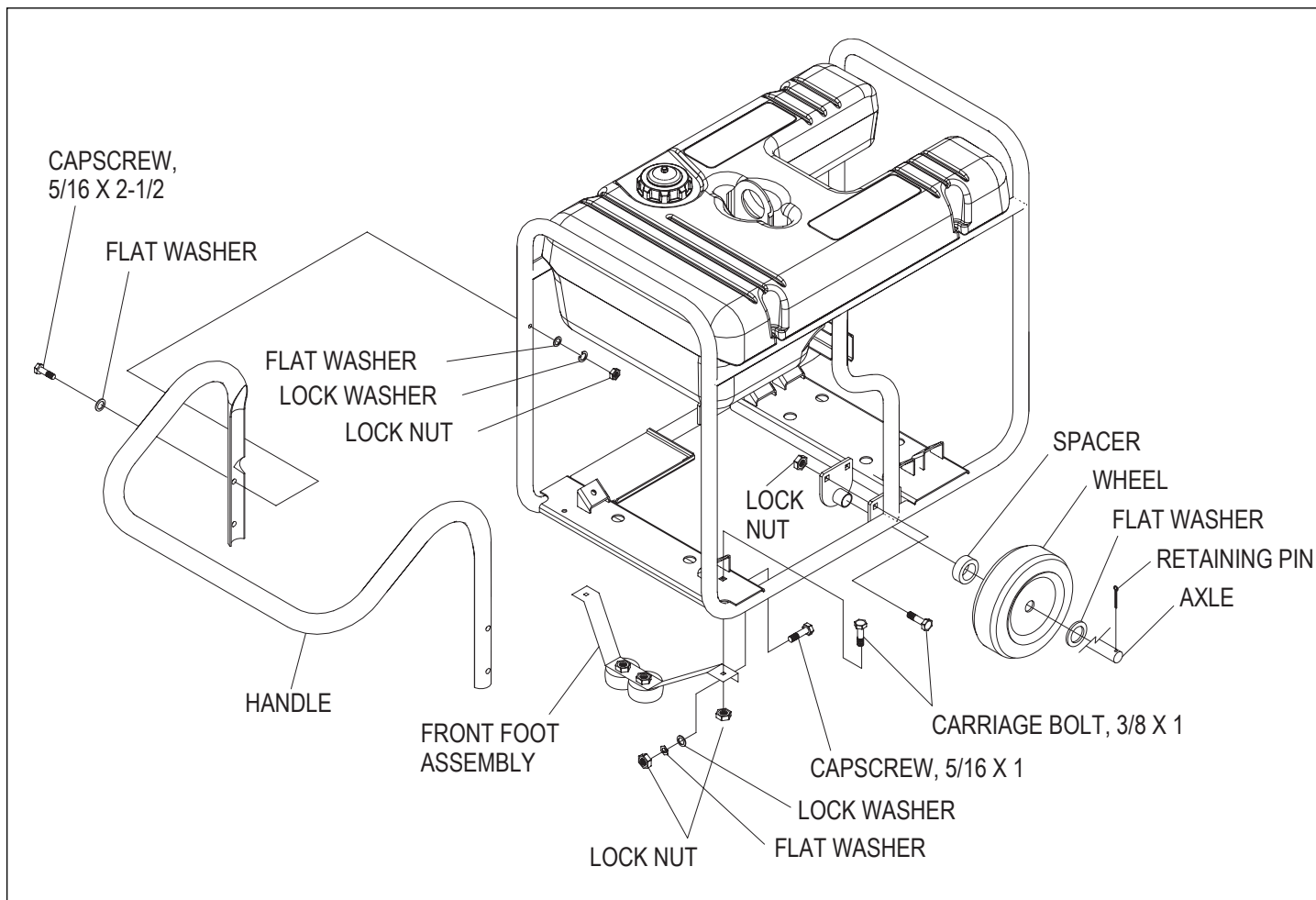

1.2.3 BATTERY CONNECTION

- The battery shipped with the generator has been provided fully charged. Caution must be taken when connecting the battery.
- Cut the tie wrap cable holding the RED and BLACK battery cables to the stator.
- Connect the RED battery cable to the battery Positive terminal (+). After making sure that the connection is tight, slip the rubber boot over the terminal connection.
- Connect the BLACK battery cable to the battery Negative terminal (-). Make sure the connection is tight.
- Double check all connections to ensure they are in the correct location and secure. See Figure 3 at right.

Figure 3 - Battery Connections

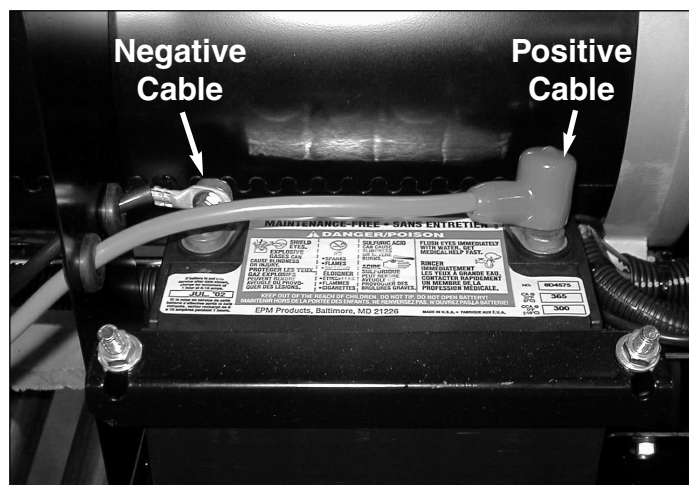

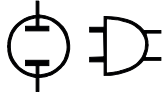

OPERATION

2.1 KNOW THE GENERATOR

Read the *Owner's Manual and Safety Rules* before operating this generator.

Compare the generator to this illustration to become familiarized with the locations of various controls and adjustments. Save this manual for future reference.

Figure 4 - Control Panel

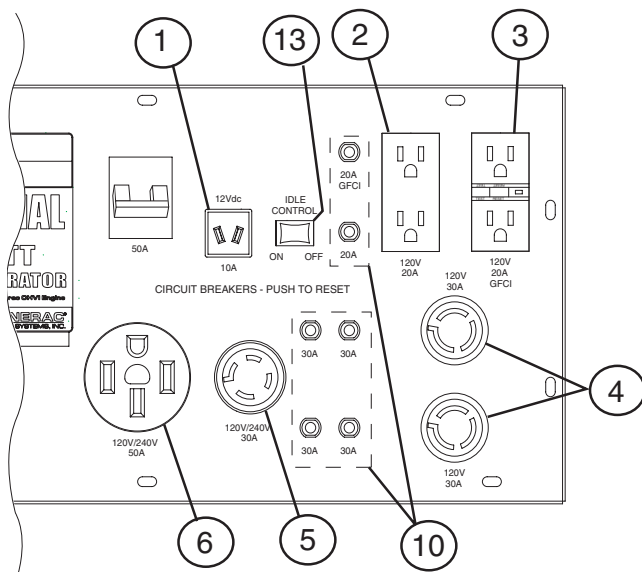
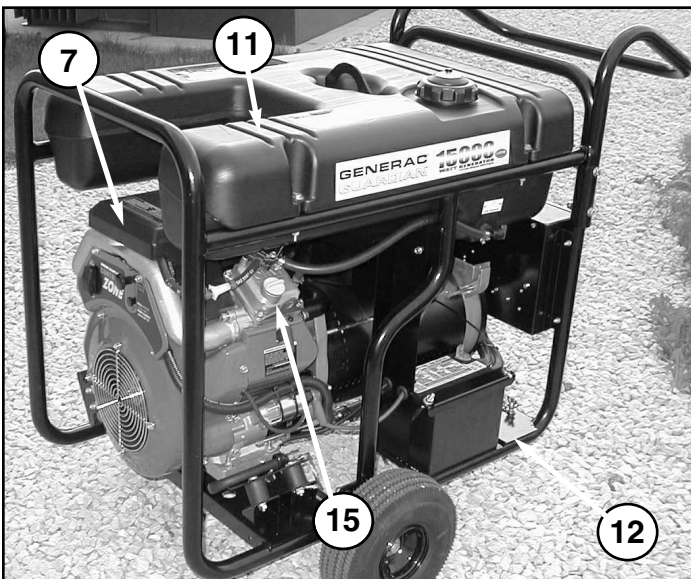
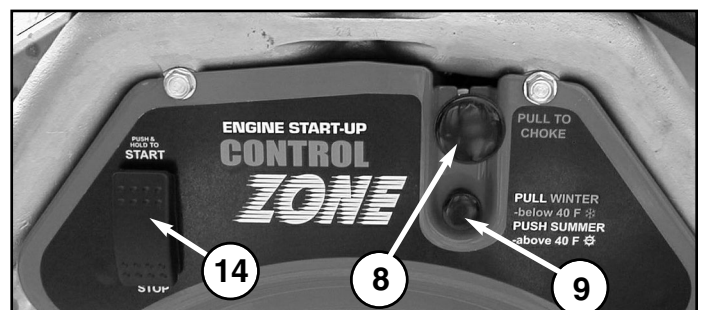

Figure 5 - Generator Controls



- 1) **12 Volt DC, 10 Amp Receptacle** – This receptacle allows the capability to recharge a 12 volt DC storage battery with provided battery charge cables.
- 2) **120 Volt AC, 20 Amp, Duplex Receptacle** – Supplies electrical power for the operation of 120 Volt AC, 20 Amp, single-phase, 60 Hz electrical lighting, appliance, tool and motor loads.
- 3) **120 Volt AC, 20A Duplex GFCI Receptacle** – Supplies ground fault protected electrical power for operation of 120 volt AC 20 amp, single-phase, 60 Hz electric lighting, appliances, tools and motor loads.
- 4) **120 Volt AC, 30 Amp Locking Receptacle** – Supplies electrical power for the operation of 120 Volt AC, 30 Amp, single-phase, 60 Hz electrical lighting, appliance, tool and motor loads.
- 5) **120/240 Volt AC, 30 Amp Locking Receptacle** – Supplies electrical power for the operation of 120 and/or 240 Volt AC, 30 Amp, single-phase, 60 Hz, electrical lighting, appliance, tool and motor loads.
- 6) **120/240 Volt AC, 50 Amp Receptacle** – Supplies electrical power for the operation of 120/240 Volt AC, 50 Amp, single-phase, 60 Hz, welder or motor loads.
- 7) **Air Cleaner** – Filters intake air as it is drawn into the engine.
- 8) **Choke Knob** – Used when starting a cold engine.
- 9) **Winter / Summer Valve** – See “Cold Weather Operation.” (Section 2, page 12.)
- 10) **Circuit Breakers (AC)** – Each receptacle is provided with a push-to-reset circuit breaker to protect the generator against electrical overload.
- 11) **Fuel Tank** – Tank holds 16 U.S. gallons of fuel.
- 12) **Grounding Lug** – Ground the generator to an approved earth ground here. See page 9 for details.
- 13) **Idle Control Switch** – The idle control runs the engine at normal (high) speeds when there is an electrical load present and runs the engine at idle (low) speeds when a load is not present.
- 14) **Start/Run/Stop Switch** – Controls the operation of the generator.
- 15) **Oil Fill** – Use this point to add oil to engine.

Figure 6 - Engine Control Panel



2.2 CORD SETS AND CONNECTION PLUGS

2.2.1 AC, 20 AMP, DUPLEX RECEPTACLE

This is a 120 Volt outlet protected against overload by a 20 Amp push-to-reset circuit breaker. Use each socket to power 120 Volt AC, single phase, 60 Hz electrical loads requiring up to a combined 2400 watts (2.4 kW) or 20 Amps of current. Use only high quality, well-insulated, 3-wire grounded cord sets rated for 125 Volts at 20 Amps (or greater).

Keep extension cords as short as possible, preferably less than 15 feet long, to prevent voltage drop and possible overheating of wires.

Figure 7 - 120 Volt AC, 20 Amp, Duplex Receptacle

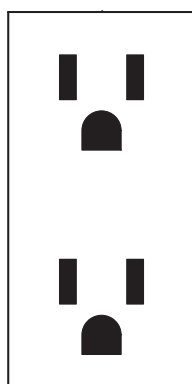

120V
20A

2.2.2 120V AC, 20 AMP, GFCI RECEPTACLE

This unit is equipped with a ground fault circuit interrupter (GFCI). This device meets applicable federal, state and local codes.

A GFCI receptacle is different from conventional receptacles. In the event of a ground fault, a GFCI will trip and quickly stop the flow of electricity to prevent serious injury.

Definition: Instead of following its normal safe path, electricity passes through a persons body to reach the ground. For example, a defective appliance can cause a ground fault.

A GFCI receptacle does NOT protect against circuit overloads, short circuits, or shocks. For example, electric shock can still occur if a person touches charged electrical wires while standing on a non-conducting surface, such as a wood floor.

Figure 8 - 120 VAC, 20 Amp GFCI Receptacle

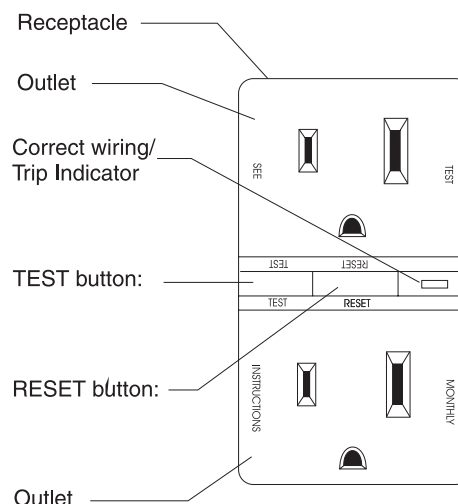

Testing the GFCI: Test the GFCI outlet every month as follows:

- Plug a test lamp into the receptacle.
- Start the generator, the test lamp should be on.
- Press the “Test” button located on the front of the receptacle to trip the device.
- This should stop the flow of electricity making the lamp shut off. The yellow trip indicator should now be on.
- To restore the flow of electricity, press the “Reset” button on the front of the receptacle. If the GFCI does not perform in this manner, do not use the receptacle. Contact a local service dealer.
- This outlet is protected against overload by a 20A push-to-reset circuit breaker. Use the outlet to power 120V AC, single-phase, 60 Hz, electrical loads requiring up to a combined 2400 watts (2.4 kW) or 20 amps of current.

2.2.3 120V AC, 30 AMP RECEPTACLE

Use a NEMA L5-30 plug with this receptacle. Connect a 3-wire cord set rated for 125 Volts AC at 30 Amps (or greater) to the plug.

Figure 9 - 120 VAC, 30 Amp Receptacle

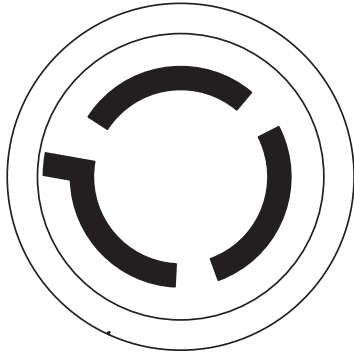
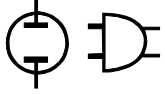

120V
30A

Use this receptacle to operate 120 Volt AC, 60 Hz, single phase loads requiring up to 3600 watts (3.6 kW) of power at 30 Amps. The outlet is protected by a 30 Amp push-to-reset circuit breaker.

2.2.4 120/240V AC, 30 AMP RECEPTACLE

Use a NEMA L14-30 plug with this receptacle. Connect a suitable 4-wire grounded cord set to the plug and to the desired load. The cord set should be rated for 250 Volts AC at 30 Amps (or greater).

Figure 10 - 120/240 VAC, 30 Amp Receptacle

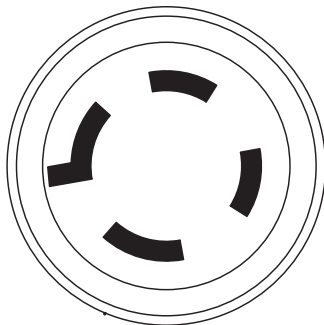

120V/240V
30A

Use this receptacle to operate 120 Volt AC, 60 Hz, single phase loads requiring up to 3600 watts (3.6 kW) of power at 30 Amps or 240 Volt AC, 60 Hz, single phase loads requiring up to 7200 watts (7.2 kW) of power at 30 Amps. The outlet is protected by two 30 Amp push-to-reset circuit breakers.

2.2.5 12 VOLT DC, 10 AMP RECEPTACLE

This receptacle allows you to recharge a 12 Volt automotive or utility style storage battery with the battery charge cables provided. This receptacle **can not** recharge 6 Volt batteries and **can not** be used to crank an engine having a discharged battery. See the section "Charging a Battery" (page 12) before attempting to recharge a battery.

Figure 11 - 12 Volt DC, 10 Amp Receptacle

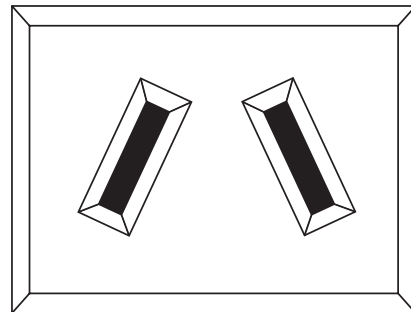

2.2.6 120/240 VOLT AC, 50 AMP RECEPTACLE

Use a NEMA 14-50 plug with this receptacle. Connect a 4-wire cord set rated for 250 Volts AC at 50 Amps to the plug.

Figure 12 - 120/240 VAC, 50 Amp Receptacle

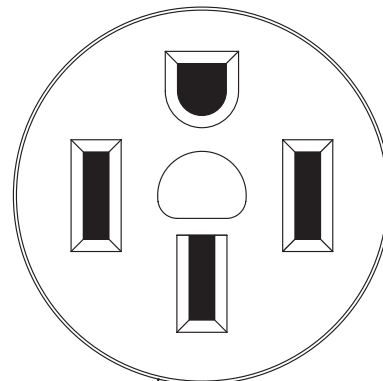

120V/240V
50A

Use this receptacle to operate 120/240 Volt AC, 60 Hz electrical loads requiring up to 12,000 watts (12.0 kW) of power. This receptacle is protected by a 50 Amp 2-pole circuit breaker.

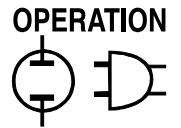

2.3 HOW TO USE THE GENERATOR

If you have any problems operating your generator, please call the generator helpline at 1-800-333-1322.

2.3.1 GROUNDING THE GENERATOR

The National Electrical Code requires that the frame and external electrically conductive parts of this generator be properly connected to an approved earth ground. Local electrical codes may also require proper grounding of the unit. For that purpose, generally, connecting a No. 10 AWG (American Wire Gauge) stranded copper wire to the grounding wing nut and to an earth-driven copper or brass grounding rod (electrode) provides adequate protection against electrical shock. However, local codes may vary widely. **Consult with a local electrician for grounding requirements in your area.**

Figure 13 - Grounding the Generator



Proper grounding of the generator will help prevent electrical shock in the event of a ground fault condition in the generator or in connected electrical devices. Proper grounding also helps dissipate static electricity, which often builds up in ungrounded devices.

2.3.2 CONNECTING ELECTRICAL LOADS

DO NOT connect 240 Volt loads to 120 Volt receptacles. **DO NOT** connect 3-phase loads to the generator. **DO NOT** connect 50 Hz loads to the generator.

- Let engine stabilize and warm up for a few minutes after starting.
- Plug in and turn on the desired 120 or 240 Volt AC, single phase, 60 Hz electrical loads.
- Add up the rated watts (or amps) of all loads to be connected at one time. This total should not be greater than (a) the rated wattage/ampere capacity of the generator or (b) circuit breaker rating of the receptacle supplying the power. See "Don't Overload the Generator" below.

2.4 DON'T OVERLOAD THE GENERATOR

Overloading a generator in excess of its rated wattage capacity can result in damage to the generator and to connected electrical devices. Observe the following to prevent overloading the unit:

- Add up the total wattage of all electrical devices to be connected at one time. This total should NOT be greater than the generator's wattage capacity.
 - The rated wattage of lights can be taken from light bulbs. The rated wattage of tools, appliances and motors can usually be found on a data plate or decal affixed to the device.
 - If the appliance, tool or motor does not give wattage, multiply volts times ampere rating to determine watts (volts x amps = watts).
 - Some electric motors, such as induction types, require about three times more watts of power for starting than for running. This surge of power lasts only a few seconds when starting such motors. Make sure you allow for this high starting wattage when selecting electrical devices to connect to your generator:
1. Figure the watts needed to start the largest motor.
 2. Add to that figure the running watts of all other connected loads.

The Wattage Reference Guide on page 10 is provided to assist you in determining how many items your generator can operate at one time. (Note: All figures are approximate. See data plate on appliance for wattage requirements.)

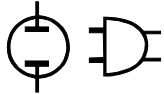

2.5 WATTAGE REFERENCE GUIDE

Device	Running Watts
*Air Conditioner (12,000 Btu)	.1700
*Air Conditioner (24,000 Btu)	.3800
*Air Conditioner (40,000 Btu)	.6000
Battery Charger (20 Amp)	.500
Belt Sander (3")	.1000
Chain Saw	.1200
Circular Saw (6-1/2")	.800 to 1000
*Clothes Dryer (Electric)	.5750
*Clothes Dryer (Gas)	.700
*Clothes Washer	.1150
Coffee Maker	.1750
*Compressor (1 HP)	.2000
*Compressor (3/4 HP)	.1800
*Compressor (1/2 HP)	.1400
Curling Iron	.700
*Dehumidifier	.650
Disc Sander (9")	.1200
Edge Trimmer	.500
Electric Blanket	.400
Electric Nail Gun	.1200
Electric Range (per element)	.1500
Electric Skillet	.1250
*Freezer	.700
*Furnace Fan (3/5 HP)	.875
*Garage Door Opener	.500 to 750
Hair Dryer	.1200
Hand Drill	.250 to 1100

Device	Running Watts
Hedge Trimmer	.450
Impact Wrench	.500
Iron	.1200
*Jet Pump	.800
Lawn Mower	.1200
Light Bulb	.100
Microwave Oven	.700 to 1000
*Milk Cooler	.1100
Oil Burner on Furnace	.300
Oil Fired Space Heater (140,000 Btu)	.400
Oil Fired Space Heater (85,000 Btu)	.225
Oil Fired Space Heater (30,000 Btu)	.150
*Paint Sprayer, Airless (1/3 HP)	.600
Paint Sprayer, Airless (handheld)	.150
Radio	.50 to 200
*Refrigerator	.700
Slow Cooker	.200
*Submersible Pump (1-1/2 HP)	.2800
*Submersible Pump (1 HP)	.2000
*Submersible Pump (1/2 HP)	.1500
*Sump Pump	.800 to 1050
*Table Saw (10")	.1750 to 2000
Television	.200 to 500
Toaster	.1000 to 1650
Weed Trimmer	.500

*Allow 3 times the listed watts for starting these devices.

2.6 BEFORE STARTING THE GENERATOR

Prior to operating the generator, engine oil and gasoline will need to be added, as follows:

2.6.1 ADDING ENGINE OIL

NOTE: When adding oil to the engine crankcase in the future, use only high quality detergent oil rated with API service classification SF or SG SAE 30 weight. Use no special additives.

Select the oil's viscosity grade according to the expected operating temperature. **Do not use SAE 10W-40.**

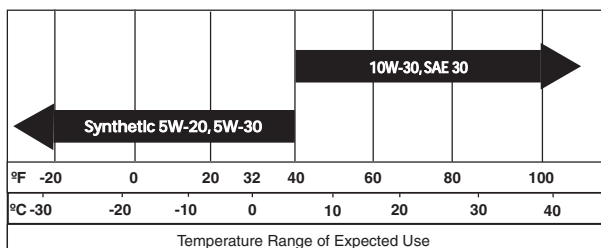

- **Above 40°F**, use SAE 10W-30 or SAE 30.
- **Below 40°F**, use synthetic 5W-20 or 5W-30.

Although multi-viscosity oils (5W-30, 10W-30, etc.) improve starting in cold weather, these multi-viscosity oils will result in increased oil consumption when used above 32°F. Check your engine oil level more frequently to avoid possible damage from running low on oil.

- Place generator on a level surface.
- Clean area around oil fill and remove oil fill cap and dipstick.
- Wipe dipstick clean.
- Slowly fill engine with oil through the oil fill opening until it reaches the full mark on the dipstick. Stop filling occasionally to check oil level. **DO NOT OVERFILL.**
- Install dipstick. Install oil fill cap and finger tighten securely.
- Check engine oil level before starting each time thereafter.

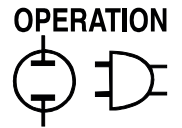

2.6.2 ADDING GASOLINE

----- ⚠ WARNING ⚠ -----

⚠ WARNING: Never fill fuel tank indoors. Never fill fuel tank when engine is running or hot. **DO NOT** light a cigarette or smoke when filling the fuel tank.

⚠ Caution: Do not overfill the fuel tank. Always leave room for fuel expansion.

- Use regular UNLEADED gasoline with the generator engine. Do not use premium gasoline. Do not mix oil with gasoline.
- Clean area around fuel fill cap, remove cap.
- Slowly add unleaded regular gasoline to fuel tank. **Be careful not to overfill.** Allow about 1/2" of tank space for fuel expansion, as shown here.
- Install fuel cap and wipe up any spilled gasoline.

Figure 14 - Fuel Tank

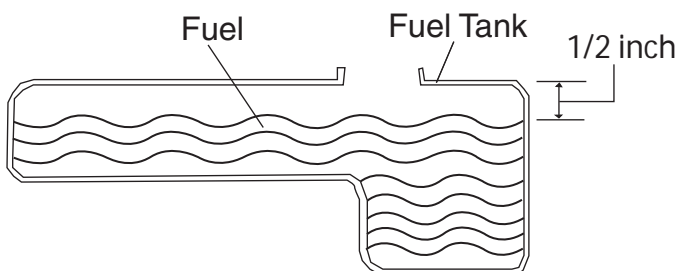

IMPORTANT: It is important to prevent gum deposits from forming in fuel system parts such as the carburetor, fuel hose or tank during storage. Alcohol-blended fuels (called gasohol, ethanol or methanol) can attract moisture, which leads to separation and formation of acids during storage. Acidic gas can damage the fuel system of an engine while in storage. To avoid engine problems, the fuel system should be emptied before storage of 30 days or longer. See "Storage" on page 18. Never use engine or carburetor cleaner products in the fuel tank as permanent damage may occur.

2.7 TO START THE ENGINE

⚠ WARNING! Never start or stop engine with electrical devices plugged into the receptacles AND devices turned on.

- Unplug all electrical loads from the unit's receptacles before starting the engine.
- Make sure the unit is in a level position.
- Open the fuel shut-off valve.

Figure 15 - Fuel Shut-off Valve

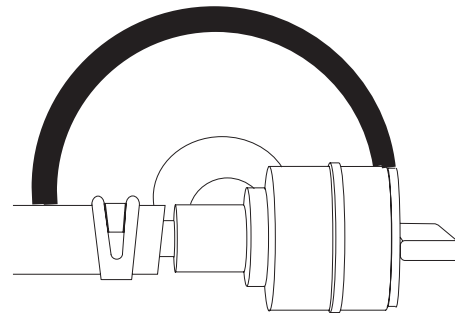
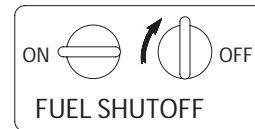

- Locate the Idle Control ON/OFF switch on the control panel and set it to the "OFF" position.

Figure 16 - Idle Control Switch

**IDLE
CONTROL**

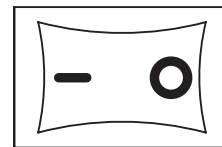

ON OFF

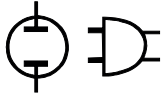

- Move engine CHOKE knob to “Full Choke” position.

17 - Full Choke Position



- To start engine, press and hold the Start/Run/Stop switch in the “Start” position. The engine will crank and attempt to start. When the engine starts, release the switch to the run position.
- When the engine starts, move choke knob to “1/2 Choke” position until the engine runs smoothly and then to “Run” position. If engine falters, move choke knob to “1/2 Choke” position until the engine runs smoothly and then to “Run” position.

Note: If engine fires, but does not continue to run, move choke lever to “Full Choke” and repeat starting instructions.

2.8 STOPPING THE ENGINE

- Shut off all loads, then unplug the electrical loads from generator panel receptacles. Never start or stop the engine with electrical devices plugged in and turned on.
- Turn “Off” the Idle Control switch (if on).
- Let engine run at no-load for several minutes to stabilize the internal temperatures of engine and generator.
- Move Start/Run/Stop switch to “Off” position.
- Close fuel valve.

IMPORTANT: Do not overload the generator. Also, do not overload individual panel receptacles. These outlets are protected against overload with push-to-reset-type circuit breakers. If amperage rating of any circuit breaker is exceeded, that breaker opens and electrical output to that receptacle is lost. Read “Don’t Overload the Generator” on page 9 carefully.

2.9 AUTOMATIC IDLE CONTROL

This feature is designed to greatly improve fuel economy. When this switch is turned “On,” the engine will only run at its normal fast governed engine speed when electrical load is connected. When the load is removed, the engine will run at a reduced speed. With the switch “Off,” the engine runs at the normal fast engine speed all the time. **Always have the switch OFF when starting and stopping the engine.**

2.10 COLD WEATHER OPERATION/ DE-ICER

Under certain weather conditions (temperatures below 40° F (4° C) and a high dew point), the engine may experience icing of the carburetor and/or the crankcase breather system. To eliminate this problem, this generator engine is fitted with a winter/summer valve. This directs hot air into the carburetor during cold weather operation. Always make sure the winter/summer valve is in the correct location relative to the weather conditions.

2.11 LOW OIL PRESSURE SHUTDOWN SYSTEM

The engine is equipped with a low oil pressure sensor that shuts down the engine automatically when the oil pressure drops below 10 psi. If the engine shuts down by itself and the fuel tank has enough gasoline, check engine oil level.

2.11.1 INITIAL START-UP

A delay built into the low oil shutdown system allows oil pressure to build during starting. The delay allows the engine to run for about 10 seconds before sensing oil pressure.

2.11.2 SENSING LOW OIL PRESSURE

If the system senses low oil pressure during operation, the engine shuts down.

2.11.3 RESTARTING

If you try to restart the engine within 10 seconds after it shuts down, the engine may NOT start. The system needs 5 to 10 seconds to reset.

If you do restart the engine after such a shutdown and have not corrected the low oil pressure, the engine runs for about 10 seconds as described above and then stops.

2.12 CHARGING A BATTERY

⚠ DANGER! Storage batteries give off explosive hydrogen gas while recharging. An explosive mixture will remain around the battery for a long time after it has been charged. The slightest spark can ignite the hydrogen and cause an explosion. Such an explosion can shatter the battery and cause blindness or other serious injury.

⚠ DANGER! Do not permit smoking, open flame, sparks or any other source of heat around a battery. Wear protective goggles, rubber apron and rubber gloves when working around a battery. Battery electrolyte fluid is an extremely caustic sulfuric acid solution that can cause severe burns. If spill occurs flush area with clear water immediately.

Your generator has the capability of recharging a discharged 12 Volt automotive or utility style storage battery. **Do not use the unit to charge any 6 Volt batteries. Do not use the unit to crank an engine having a discharged battery.**

To recharge 12 Volt batteries, proceed as follows:

- Check fluid level in all battery cells. If necessary, add **ONLY** distilled water to cover separators in battery cells. **Do not use tap water.**
- If the battery is equipped with vent caps, make sure they are installed and are tight.
- If necessary, clean battery terminals.
- Connect battery charge cable connector plug to panel receptacle identified by the words "12-VOLT D.C."
- Connect battery charge cable clamp with red handle to the positive (+) battery terminal.
- Connect battery charge cable clamp with black handle to the negative (-) battery terminal.
- Start engine. Let the engine run while battery recharges. Engine idle control switch must be in off position for battery charging.
- When battery has charged, shut down engine.

Note: Use an automotive hydrometer to test battery state of charge and condition. Follow the hydrometer manufacturer's instructions carefully. Generally, a battery is considered to be at 100% state of charge when specific gravity of its fluid (as measured by hydrometer) is 1.260 or higher.

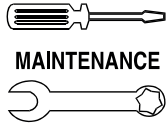

Section 3 — Maintenance

Commercial-Industrial-Residential Portable Generator System

3.1 MAINTENANCE SCHEDULE

Follow the calendar intervals. More frequent service is required when operating in adverse conditions noted below.

Operation Maintenance	Daily	Every Season	Every Season	Every Season
Check Oil Level	✓			
Service Air Pre-Cleaner		✓**		
Change Oil and Oil Filter‡				✓*
Clean Spark Arrestor Screen			✓	
Adjust Valve Clearance			✓	
Service Air Cleaner				✓**
Replace Spark Plugs				✓

‡ Change oil after first 8 hours of operation then every season.
 * Change oil and oil filter every month when operating under heavy load or in high temperatures.
 ** Clean more often under dirty or dusty operating conditions. Replace air cleaner parts if very dirty..

PRODUCT SPECIFICATIONS

3.2.1 GENERATOR SPECIFICATIONS

MODEL	GPS 12500	GPS 15000
Model #	004451-1	004582-1
Rated Max. Power	12.5 kW	15.0 kW
Surge Power	18.75 kW	22.5 kW
Rated AC Voltage	120/240	120/240
Rated Max AC Load		
Current @ 240V	52.0 Amps	62.5 Amps
Current @ 120V	104.0 Amps	125.0 Amps
Rated Frequency	60 Hz @3600 RPM	
Phase	Single Phase	
Rated DC Voltage	12 Volts	
Rated Max DC Load		
Current @ 12 Volts	10 Amperes	

3.2.2 ENGINE SPECIFICATIONS

Rated Horsepower		
@ 3600 RPM	27	30
Displacement	760cc	992cc
Spark Plug Type	Champion RC12YC or Equivalent	
Spark Plug Gap	0.030 inch or (0.76 mm)	
Gasoline Capacity	16 U.S. gallons	
Oil Type	Summer – SAE 30 or 10W-30 Winter – Synthetic 5W-20 or 5W-30	
Oil Capacity	w/Filter Change = 1.5 Qts. w/o Filter Change = 1.2 Qts.	
Run Time/Fuel Consumption-1/2 Load	10 Hours / 1.6 gallons per hour	

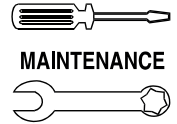

3.3 GENERAL RECOMMENDATIONS

The warranty of the generator does not cover items that have been subjected to operator abuse or negligence. To receive full value from the warranty, the operator must maintain the generator as instructed in this manual.

Some adjustments will need to be made periodically to properly maintain the generator.

All adjustments in the Maintenance section (3) of this manual should be made at least once each season. Follow the requirements in the "Maintenance Schedule" chart on page 14.

NOTE: Once a year you should replace the spark plug and replace the air filter. A new spark plug and clean air filter assure proper fuel-air mixture and help your engine run better and last longer.

3.3.1 GENERATOR MAINTENANCE

Generator maintenance consists of keeping the unit clean and dry. Operate and store the unit in a clean dry environment where it will not be exposed to excessive dust, dirt, moisture or any corrosive vapors. Cooling air slots in the generator must not become clogged with snow, leaves, or any other foreign material.

Check the cleanliness of the generator frequently and clean when dust, dirt, oil, moisture or other foreign substances are visible on its exterior surface.

⚠ CAUTION! Never insert any object or tool through the air cooling slots, even if the engine is not running.

Note: DO NOT use a garden hose to clean generator. Water can enter the engine fuel system and cause problems. In addition, if water enters the generator through cooling air slots, some water will be retained in voids and crevices of the rotor and stator winding insulation. Water and dirt buildup on the generator internal windings will eventually decrease the insulation resistance of these windings.

3.3.2 TO CLEAN THE GENERATOR

- Use a damp cloth to wipe exterior surfaces clean.
- A soft, bristle brush may be used to loosen caked on dirt, oil, etc.
- A vacuum cleaner may be used to pick up loose dirt and debris.
- Low pressure air (not to exceed 25 psi) may be used to blow away dirt. Inspect cooling air slots and openings on the generator. These openings must be kept clean and unobstructed.

3.3.3 ENGINE MAINTENANCE

DANGER! When working on the generator, always disconnect negative cable from battery. Also disconnect spark plug wires from spark plug and keep wire away from spark plug.

3.3.4 CHECKING OIL LEVEL

See the "BEFORE STARTING THE GENERATOR" section on page 10 for information on checking the oil level. The oil level should be checked before each use, or at least every eight hours of operation. Keep the oil level maintained.

3.3.5 CHANGING THE OIL AND OIL FILTER

Change the oil and filter after the first eight hours of operation. Change the oil every 100 hours thereafter. If you are running this unit under dirty or dusty conditions, or in extremely hot weather, change the oil more often.

Use the following instructions to change the oil while the engine is still warm:

- Clean area around oil drain hose and plug.
- Remove oil drain plug from end of hose and oil fill plug to drain oil completely into a suitable container.
- When oil has completely drained, install oil drain plug and tighten securely.
- Place a suitable container beneath the oil filter and turn filter counterclockwise to remove. Discard according to local regulations.
- Coat gasket of new filter with clean engine oil. Turn filter clockwise until gasket contacts lightly with filter adapter. Then tighten an additional 3/4 turn.
- Fill oil sump with recommended oil. (See "Before Starting the Generator" on page 10 for oil recommendations).
- Wipe up any spilled oil.

3.3.6 REPLACING THE SPARK PLUG

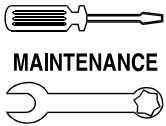

MAINTENANCE

Section 3 — Maintenance

Commercial-Industrial-Residential Portable Generator System

Use Champion RC12YC spark plug or equivalent. The correct air gap is 0.76 mm (0.030 in.). **Replace the plug once each year.** This will help your engine start easier and run better.

1. Stop the engine and pull the spark plug wire off of the spark plug.
2. Clean the area around the spark plug and remove it from the cylinder head.
3. Set the spark plug's gap to 0.76 mm (0.030 in.). Install the correctly gapped spark plug into the cylinder head.

Figure 18 - Spark Plug Gap

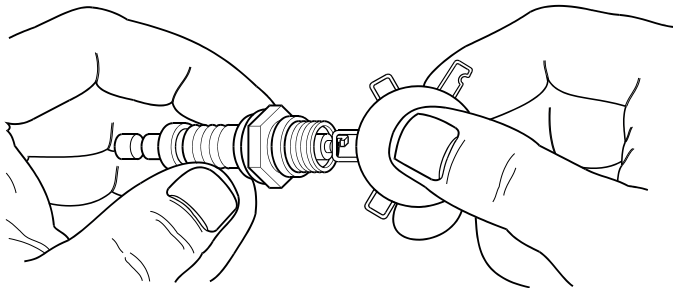

3.4 SERVICE AIR CLEANER

Your engine will not run properly and may be damaged if you run it using a dirty air cleaner. Clean or replace the air cleaner paper filter once a year. Clean or replace more often if operating under dusty conditions. Clean foam pre-cleaner every month or more often under dusty conditions.

Figure 20 - Air Cleaner

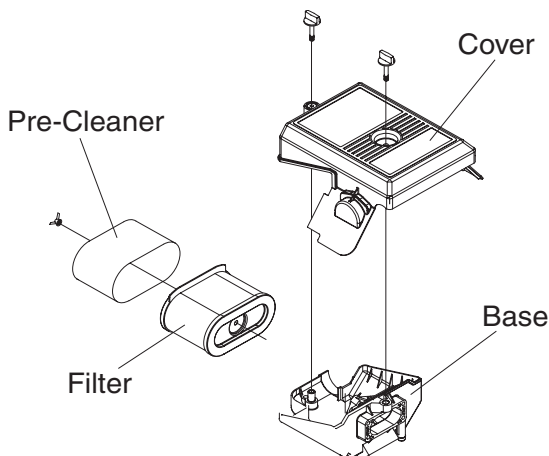

To clean or replace foam pre-cleaner:

- Remove air cleaner cover, then foam pre-filter.

- Wash pre-cleaner in soapy water. Squeeze pre-filter dry in clean cloth (DO NOT TWIST).
- Clean air cleaner cover before re-installing it.

To clean or replace paper air filter:

- Remove air cleaner cover; then remove foam pre-filter (service if necessary) and remove paper filter.
- Clean paper filter by tapping it gently on a solid surface. If the filter is too dirty, replace it with a new one. Dispose of the old filter properly.
- Clean air cleaner cover then slip pre-cleaner over filter. Next insert new paper filter into the base of the air cleaner. Re-install air cleaner cover.

Note: To order a new air filter, please contact the nearest authorized service center at 1-800-333-1322.

3.5 CLEAN SPARK ARRESTOR SCREEN

The engine exhaust muffler has a spark arrestor screen. Inspect and clean the screen at least once each year. If unit is used regularly, inspect and clean more often.

NOTE: If you use your generator on any forest-covered, brush-covered or grass-covered unimproved land, it must be equipped with a spark arrestor. The spark arrestor must be maintained in good condition by the owner/operator.

Clean and inspect the spark arrestor as follows:

- Remove the screen retaining bracket by removing the screw.
- Slide the spark arrestor screen out from the tail pipe.
- Inspect screen and replace if torn, perforated or otherwise damaged. DO NOT USE a defective screen. If screen is not damaged, clean it with commercial solvent.
- Replace the screen and the retaining bracket.

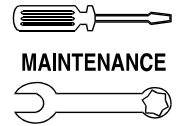
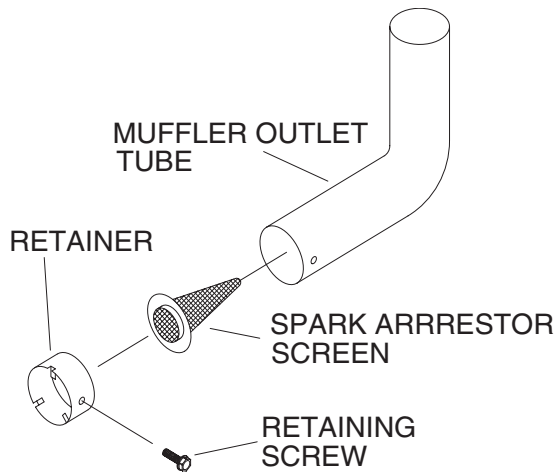
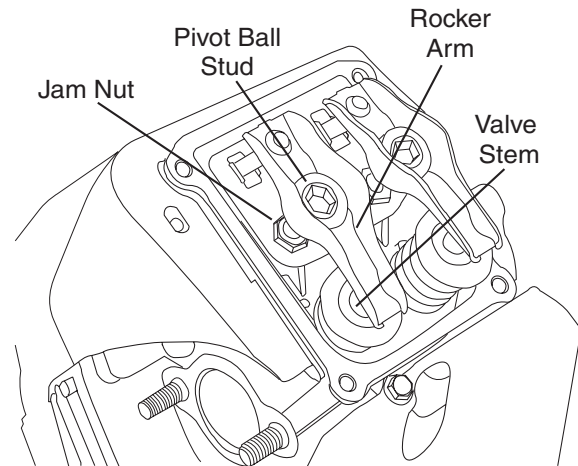

Figure 21 - Spark Arrestor



the allen wrench and tighten the rocker arm jam nut. Tighten the jam nut to 174 in/lbs. torque. After tightening the jam nut, recheck valve clearance to make sure it did not change.

Figure 22 - Valve Clearance Adjustment



3.6 ADJUSTING VALVE CLEARANCE

After the first 50 hours of operation, you should adjust the valve clearance in the engine.

Important: If you feel uncomfortable about doing this procedure or you don't have the proper tools, please take your generator in to the nearest service center to have the valve clearance adjusted. This is a very important step to insure longest life for your engine.

To adjust valve clearance:

- Make sure the engine is at room temperature.
- Make sure that the spark plug wire is removed from the spark plug and out of the way.
- Remove the four screws attaching the valve cover with a #2 or #3 phillips screwdriver.
- Make sure the piston is at Top Dead Center (TDC) of its compression stroke (both valves closed). To get the piston at TDC, remove the intake screen at the front of the engine to gain access to the flywheel nut. Use a large socket and socket wrench to rotate the nut and hence the engine. While watching the piston through the spark plug hole. The piston should move up and down. The piston is at TDC when it is up as high as it can go.
- Loosen the rocker jam nut. Use an 10mm allen wrench to turn the pivot ball stud while checking clearance between the rocker arm and the valve stem with a feeler gauge. Correct clearance is 0.002-0.004 inch (0.05-0.1 mm).

NOTE: You must hold the rocker arm jam nut in place as you turn the pivot ball stud.

When valve clearance is correct, hold the pivot ball stud in place with

- Install new valve cover gasket.
- Re-attach the valve cover.

NOTE: Start all four screws before tightening or you will not be able to get all the screws in place. Make sure the valve cover gasket is in place.

- Re-attach the spark plug wire to the spark plug.
- Repeat the process for the other cylinder.

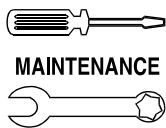

MAINTENANCE

Section 3 — Maintenance

Commercial-Industrial-Residential Portable Generator System

STORAGE

3.7 GENERAL

The generator should be started at least once every seven days and be allowed to run at least 30 minutes. If this cannot be done and you must store the unit for more than 30 days, use the following information as a guide to prepare it for storage.

⚠️⚠️ DANGER! NEVER store engine with fuel in tank indoors or in enclosed, poorly ventilated areas where fumes may reach an open flame, spark or pilot light as on a furnace, water heater, clothes dryer or other gas appliance.

3.8 LONG TERM STORAGE

It is important to prevent gum deposits from forming in essential fuel system parts such as the carburetor, fuel hose or tank during storage. Also, experience indicates that alcohol-blended fuels (called gasohol, ethanol or methanol) can attract moisture, which leads to separation and formation of acids during storage. Acidic gas can damage the fuel system of an engine while in storage.

To avoid engine problems, the fuel system should be emptied before storage of 30 days or longer, as follows:

- Remove all gasoline from the fuel tank.

⚠️⚠️ DANGER! Drain fuel into approved container outdoors, away from open flame. Be sure engine is cool. Do not smoke.

- Start and run engine until engine stops from lack of fuel.
- While engine is still warm, drain oil from crankcase. Refill with recommended grade.
- Remove spark plugs and pour about 1/2 ounce (15 ml) of engine oil into the cylinders. Cover spark plug hole with rag. Press the "Start" button and allow engine to crank for 2 seconds. Then press the "Stop" button.

⚠️ CAUTION! Avoid spray from spark plug holes when cranking engine.

- Install and tighten spark plugs. Do not connect spark plug wires.
- Clean the generator outer surfaces. Check that cooling air slots and openings on generator are open and unobstructed.
- Store the unit in a clean, dry place.

3.9 OTHER STORAGE TIPS:

- Do not store gasoline from one season to another.
- Replace your gasoline can if your can starts to rust. Rust and/or dirt in your gasoline will cause problems with the carburetor and fuel system.
- If possible, store your unit indoors and cover it to give protection from dust and dirt. **BE SURE TO EMPTY THE FUEL TANK.**
- If it is not practical to empty the fuel tank and the unit is to be stored for some time, use a commercially available fuel stabilizer added to the gasoline to increase the life of the gasoline.
- Cover your unit with a suitable protective cover that does not retain moisture.

⚠️ DANGER! NEVER cover your generator while engine and exhaust area are warm.



4.1 TROUBLESHOOTING

PROBLEM	CAUSE	SOLUTION
Engine is running, but no AC output is available.	<ol style="list-style-type: none"> 1. Circuit breaker is open. 2. Poor connection or defective cord set. 3. Connected device is bad. 4. Fault in generator. 	<ol style="list-style-type: none"> 1. Reset circuit breaker. 2. Check and repair. 3. Connect another device that is in good condition. 4. Contact Authorized Service Facility.
Engine runs good but bogs down when loads are connected.	<ol style="list-style-type: none"> 1. Short circuit in a connected load. 2. Generator is overloaded. 3. Engine speed is too slow. 4. Shorted generator circuit. 	<ol style="list-style-type: none"> 1. Disconnect shorted electrical load. 2. See <i>"Don't Overload the Generator"</i> on page 9. 3. Contact Authorized Service Facility. 4. Contact Authorized Service Facility.
Engine will not start; or starts and runs rough.	<ol style="list-style-type: none"> 1. Dirty air cleaner. 2. Out of gasoline. 3. Stale gasoline. 4. Spark plug wire not connected to spark plug. 5. Bad spark plug. 6. Water in gasoline. 7. Overchoking. 8. Low oil level. 9. Excessive rich fuel mixture. 10. Intake valve stuck open or closed. 11. Engine has lost compression. 	<ol style="list-style-type: none"> 1. Clean or replace air cleaner. 2. Fill fuel tank. 3. Drain fuel tank and fill with fresh fuel. 4. Connect wire to spark plug. 5. Replace spark plug. 6. Drain fuel tank; fill with fresh fuel. 7. Put choke knob to No Choke position. 8. Fill crankcase to proper level. 9. Contact Authorized Service Facility. 10. Contact Authorized Service Facility. 11. Contact Authorized Service Facility.
Engine shuts down during operation.	<ol style="list-style-type: none"> 1. Out of gasoline. 2. Low oil level. 3. Fault in engine. 	<ol style="list-style-type: none"> 1. Fill fuel tank. 2. Fill crankcase to proper level. 3. Contact Authorized Service Facility.
Engine lacks power.	<ol style="list-style-type: none"> 1. Load is too high. 2. Dirty air filter. 3. Engine needs to be serviced. 	<ol style="list-style-type: none"> 1. See <i>"Don't Overload the Generator"</i> on page 9. 2. Replace air filter. 3. Contact Authorized Service Facility.
Engine "hunts" or falters.	<ol style="list-style-type: none"> 1. Choke is opened too soon. 2. Carburetor is running too rich or too lean. 	<ol style="list-style-type: none"> 1. Move choke to halfway position until engine runs smoothly. 2. Contact Authorized Service Facility.
No Battery Charge DC output.	<ol style="list-style-type: none"> 1. Battery posts are corroded. 2. Battery cable is bad. 3. Battery is defective. 4. Receptacle is bad. 	<ol style="list-style-type: none"> 1. Clean battery posts. 2. Replace cable. 3. Check battery condition; replace if defective. 4. Contact Authorized Service Facility.

Section 6 — Electrical Data
Commercial-Industrial-Residential Portable Generator System
Schematic – Drawing No. 0E0229

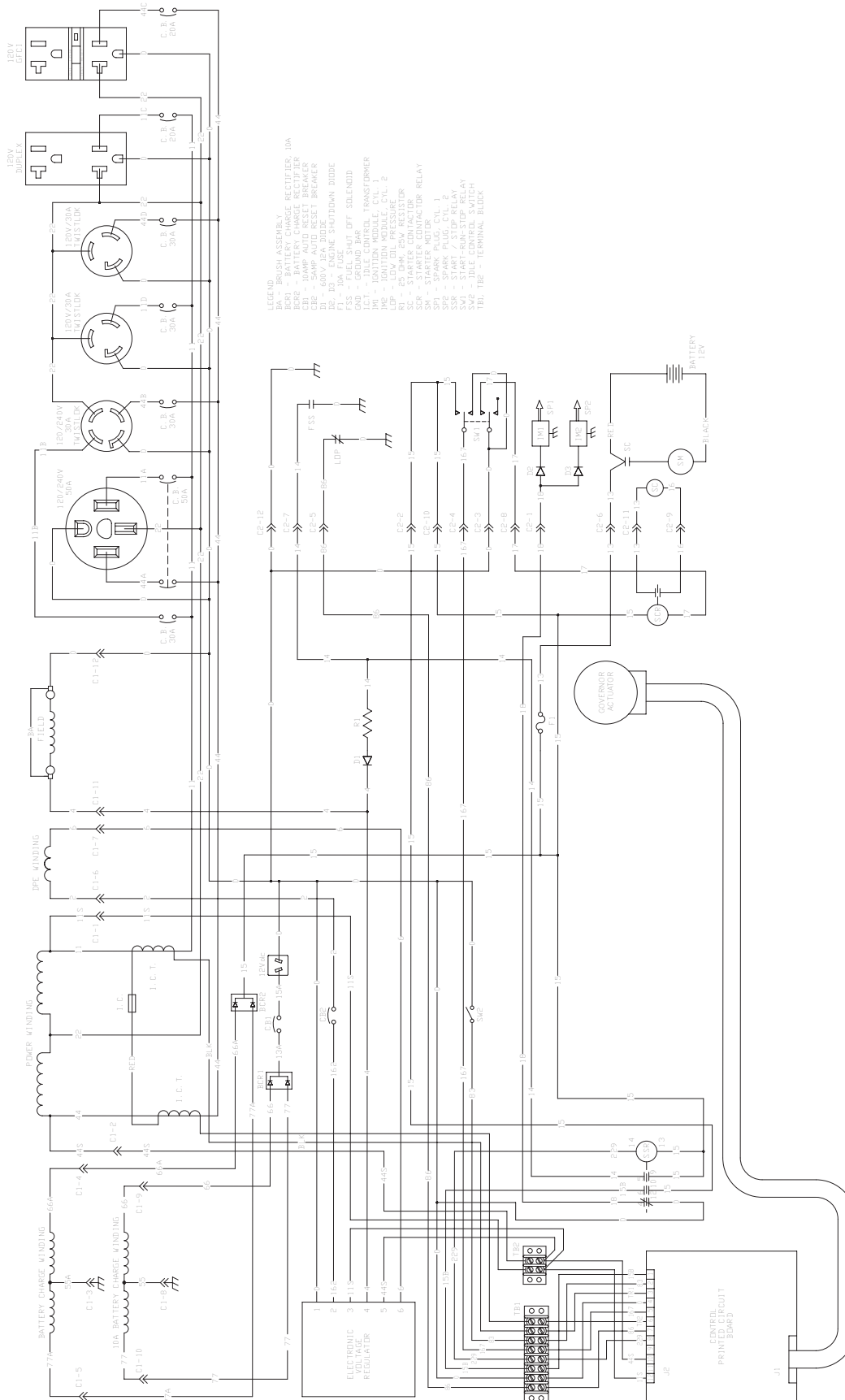
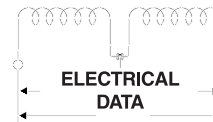

Section 7 — Exploded Views and Parts Lists

**Commercial-Industrial-Residential Portable Generator System
GT-990 & GT-760 Engine (Page 1) – Drawing No. 0E0034**

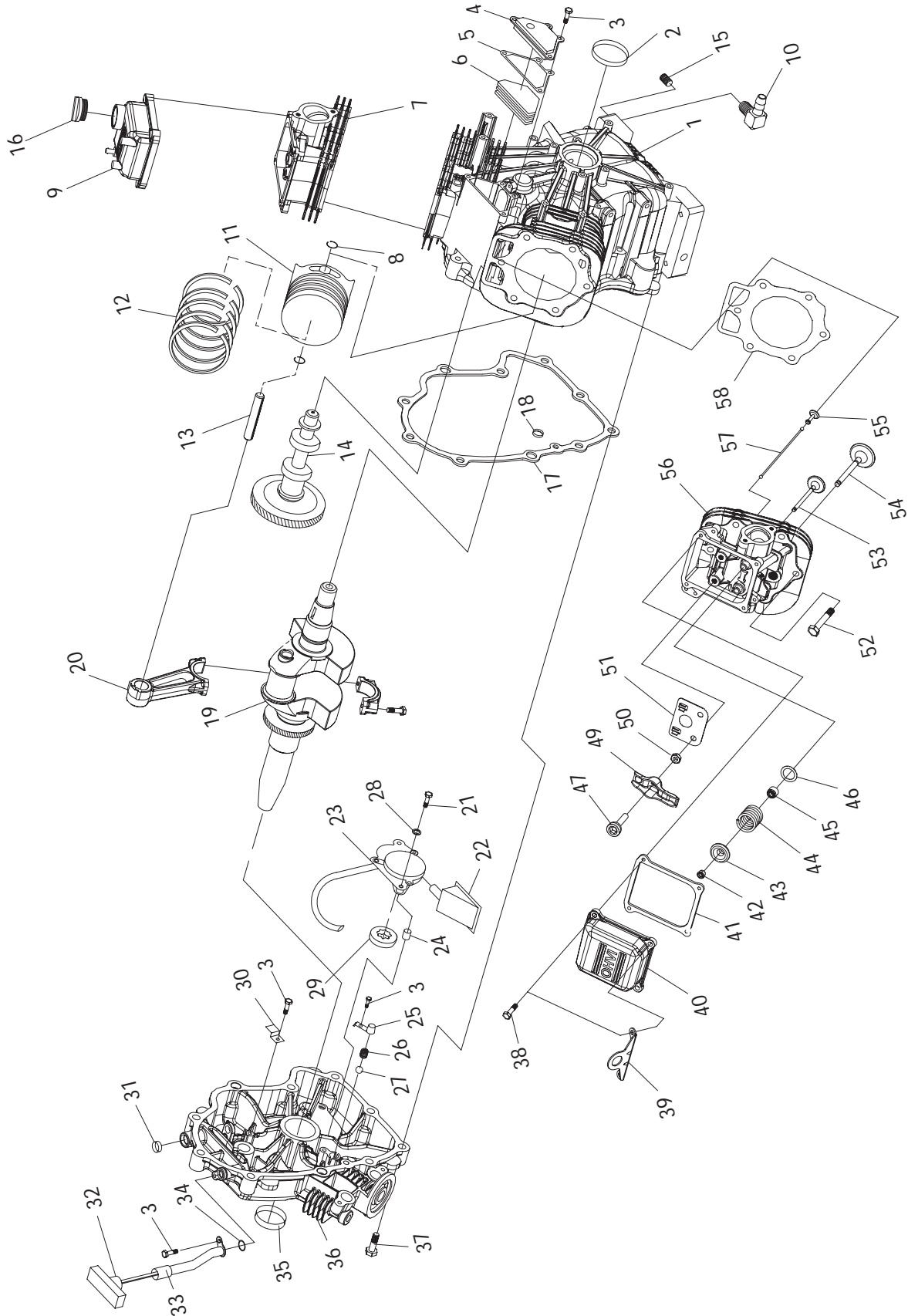

Section 7 — Exploded Views and Parts Lists

**Commercial-Industrial-Residential Portable Generator System
GT-990 & GT-760 Engine (Page 1) – Drawing No. 0E0034**

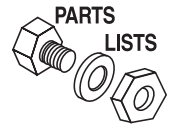

ITEM	PART NO.	QTY.	DESCRIPTION	ITEM	PART NO.	QTY.	DESCRIPTION
1	0C5729	1	ASSEMBLY, CRANKCASE HOUSING WITH SLEEVE	37	0C3006	11	SCREW, HHFC M10-1.5 X 55
2	0C3008	1	SEAL, 38 I.D. CRANKSHAFT	38	0C8566	8	SCREW HHFC M6-1.0 X 20
3	090388	8	SCREW, TAPTITE M6-1.0 X 12 BP	39	0C8808	2	HOOK, LIFTING
4	0C5372	1	ASSEMBLY, BREATHER	40	0C2981	1	ROCKER, COVER
5	0C3005	1	GASKET, BREATHER COVER	41	0C2979	2	GASKET, VALVE COVER
6	0C3003	3	SEPARATOR, OIL BREATHER	42	086515	8	KEEPER, VALVE SPRING
7	0D8067A	1	ASSEMBLY, HEAD #1	43	0D2274	4	RETAINER, VALVE SPRING
8	071983	4	RETAINER, PISTON PIN 20	44	0D3867	4	SPRING, VALVE
9	0D5269	1	ROCKER, COVER	45	078672	2	SEAL, VALVE STEM D7
10	043790A	1	BARBED EL 90 3/8NPT X 3/8	46	0C5371	4	WASHER, VALVE SPRING
11	0C2967	2	PISTON, LC	47	072694	4	STUD, D20 PIVOT BALL
12	021533	2	SET, PISTON RING 90MM	49	0D5313	4	ROCKER ARM
13	071980	2	PIN PISTON D20	50	0D3998	4	NUT, HEX M8-1.0 GB YELLOW CHROME
14	0D4041	1	ASSEMBLY, CAMSHAFT & GEAR	51	0D6024	2	PLATE, PUSH ROD GUIDE
15	0D4788	2	PLUG STD PIPE 3/8 STEEL SQ HD	52	0C2976	12	SCREW HHFC M8-1.25 X 65
16	093064	1	ASSEMBLY, OIL FILL CAP	53	086516	2	VALVE, EXHAUST
17	0C2977	1	GASKET, CRANK CASE	54	0C2229	2	VALVE, INTAKE
18	0C5943	1	SEAL, OIL PASSAGE	55	083897	4	TAPPET, SOLID
19	0D4040E	1	ASSEMBLY, CRANKSHAFT HORIZONTAL DIRECT DRIVE (GT-990)	56	0D8067B	1	ASSEMBLY, HEAD #2
19	0D4122E	1	ASSEMBLY, CRANKSHAFT HORIZONTAL DIRECT DRIVE (GT-760)	57	0D9853D	4	PUSHROD 144.6
20	0C2969	2	ASSEMBLY, CONNECTING ROD (GT-990)	58	0C2978	2	GASKET, HEAD (GT-990)
20	0D3961	2	ASSEMBLY, CONNECTING ROD (GT-760)	59	0D9000	2	GASKET, HEAD (GT-760)
21	0D2157	2	SCREW SHC M6-1.0 X 50 G8.8	59	0D6008	1	KIT GEAR COVER
22	0C5313	1	SCREEN, OIL PICKUP	60	0D4010	1	KIT GASKET
23	0D4123	1	ASSEMBLY, OIL PUMP	61	0D6007	1	KIT PISTON & RINGS
24	078699E	2	SLEEVE, SEAMED DOWEL 10 DIA.	62	0D4012	1	KIT BREATHER ASSEMBLY
25	0C3011	2	COVER, OIL RELIEF	63	0D8675A	1	KIT HEAD ASSEMBLY CYLINDER 1
26	0C3009	2	SPRING, OIL RELIEF	64	0D8675B	1	KIT HEAD ASSEMBLY CYLINDER 2
27	0C3010	2	BALL, 1/2D OIL RELIEF	65	0D4015	1	KIT OIL RELIEF
28	093873	2	WASHER, LOCK RIB M6				Item 59 (Kit) includes items 3, 30, 35 & Kit item 64
29	0C5315	1	GEROTOR, OUTER				Item 60 (Kit) includes items 2, 5, 17, 18, 34, 35, 40, 57, 139, 153.
30	0C5998	1	CLAMP, OIL TUBE				Item 61 (Kit) includes items 8, 11, 12, 13
31	0D4497	1	PLUG-CRANKCASE GOVERNOR BORE				Item 62 (Kit) includes items 4, 5, 6
32	0C3971E	1	ASSEMBLY, DIPSTICK WITH HANDLE				Item 63 (Kit) includes items 7, 42, 43, 44, 45, 46, 47, 48, 49, 50, 51, 52, 53, 54
33	0D3745	1	TUBE, DIPSTICK				Item 64 (Kit) includes items 42, 43, 44, 45, 46, 47, 48, 49, 50, 51, 52, 53, 54, 56
34	0C3027	3	O-RING, OIL CLR				Item 65 (Kit) includes items 25, 26, 27
35	0C3007	1	SEAL, 42 I.D. CRANKSHAFT				
36	0C5731	1	ASSEMBLY, HOUSING COVER WITH SLEEVE				

Section 7 — Exploded Views and Parts Lists

**Commercial-Industrial-Residential Portable Generator System
GT-990 & GT-760 Engine (Page 2) – Drawing No. 0E0034**

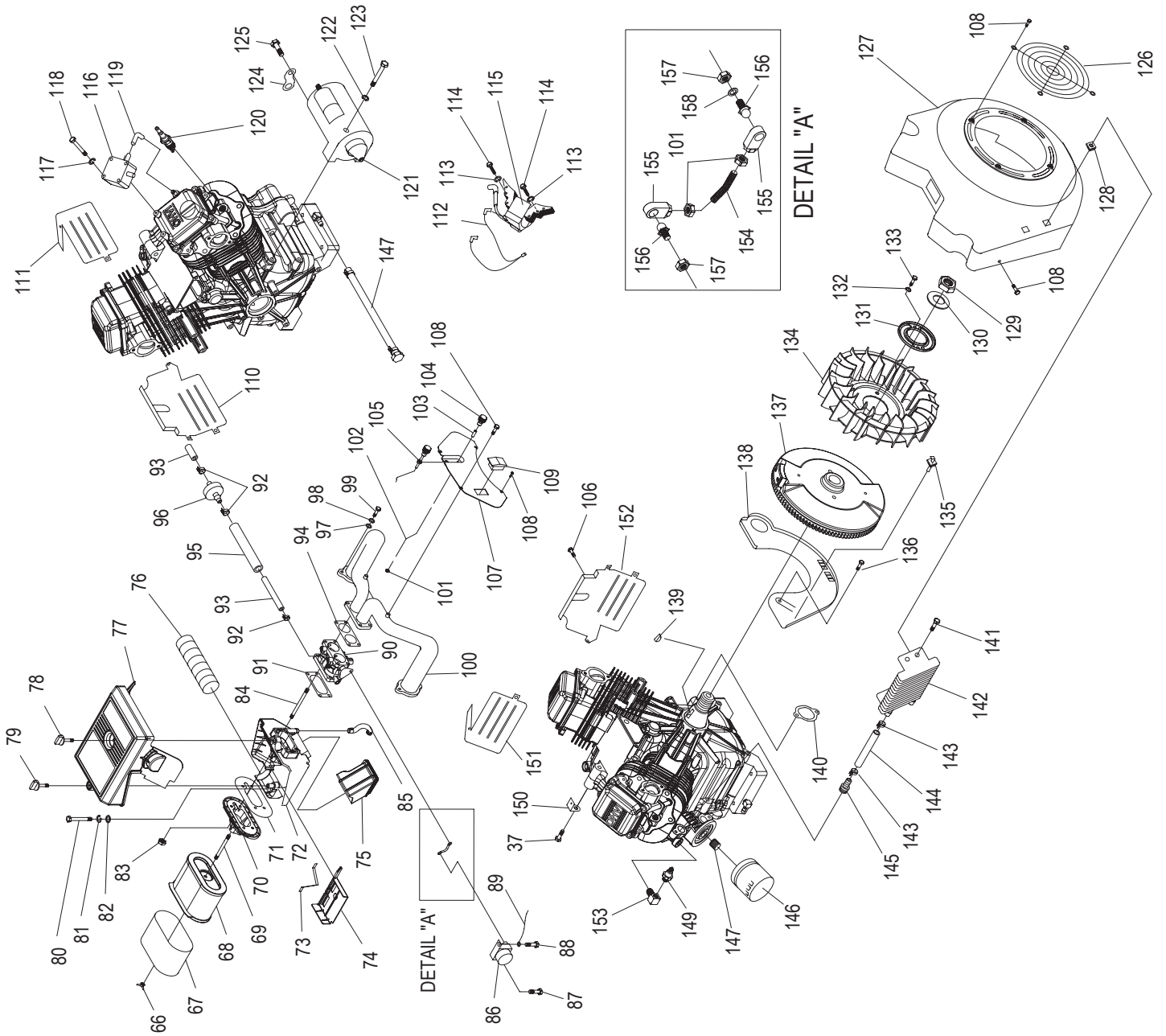

Section 7 — Exploded Views and Parts Lists

Commercial-Industrial-Residential Portable Generator System GT-990 & GT-760 Engine (Page 2) – Drawing No. 0E0034

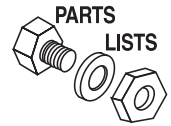

ITEM	PART NO.	QTY.	DESCRIPTION	ITEM	PART NO.	QTY.	DESCRIPTION
66	087680	1	WINGNUT, AIRBOX	118	0D6142	2	SCREW PPHM M4-0.7 X 40
67	0D4511	1	PRECLEANER, AIR	119	0D5399	1	ELBOW, RUBBER 90 DEG.
68	0D3262	1	ELEMENT, AIR CLEANER	120	072347	2	SPARKPLUG
69	0D6020	1	STUD M6-1.0 X 73	121	0C3017	1	STARTER
70	0D4183	1	ADAPTOR, SPIT BACK	122	022129	2	WASHER LOCK M8-5/16
71	0D6327	1	GASKET, SPITBACK	123	061906	2	SCREW HHC M8-1.25 X 85 G8.8
72	0D2774B	1	BASE, AIRBOX	124	0C8919	1	BRACKET, STARTER
73	0D5125	1	SPRING, WINTER/SUMMER VALVE	125	079246	1	SCREW HHC M6-1.0 X 16mm W/ LOCKWASHER
74	0D2930	1	VALVE, SUMMER / WINTER	126	0D1131	1	GUARD,FAN
75	0D4612	1	SNORKEL, AIR INTAKE	127	0C3022B	1	HOUSING, BLOWER GASOLINE COOLER
76	0D6143	1	TUBE, HEAT RISER 50.8 I.D.	128	0C9763	4	NUT, GROMMET 1/4 PLUG
77	0D2775	1	COVER, AIRBOX	129	0C3034	1	NUT,HEX M24
78	0D5014A	1	KNOB, AIRBOX 17mm	130	0C3033	1	WASHER, M24
79	0D5014B	1	KNOB, AIRBOX 95MM	131	0C3032	1	PLATE, FAN
80	049721	1	SCREW HHC M6-1.0 X 35	132	0A5992	2	WASHER SHAKEPROOF INT M8 SS
81	022097	1	WASHER LOCK M6-1/4	133	051754	2	SCREW HHC M8-1.25 X 12 G8.8
82	022473	1	WASHER FLAT 1/4	134	0C3031	1	FAN, NYLON
83	052857	4	NUT LOCK FLANGE M6-1.0	135	085011	1	INSULATOR ASSEMBLY IGNITION
84	0D6021	4	STUD, METRIC	136	045756	4	SCREW TAPTITE M6-1X10 YELLOW CHROME
85	0C9093	1	HOSE, BREATHER	137	0C3725A	1	FLYWHEEL ASSEMBLY
86	0D4522	1	CONTROLLER ASSEMBLY	138	0C3016A	1	PLATE, BACKING GT990 WITH OIL COOL
87	074908	1	SCREW HHTT M5-0.8 X 10	139	082774	1	KEY, WOODRFF 4 X 19D
88	066849B	1	SCREW HHTT M5-0.8 X 8mm	140	0C3043	2	GASKET, MANIFOLD / PORT
89	0536210209	1	ASSEMBLY, WIRE	141	0C9764	4	PLASTITE,1/4-15 X 3/4
90	0C8526	1	CARBURETOR (GT-990)	142	0C3026	1	COOLER, OIL
	0D8059	1	CARBURETOR (GT-760)	143	040173	4	CLAMP HOSE #5.5 .62 - .62
91	0D4024	1	GASKET,CARB TO SPACER	144	0C9806	2	HOSE, 3/8" I.D. X 6" LONG
92	048031C	4	CLAMP HOSE BAND 1/4	145	035461A	2	BARBED STR 1/4NPT X 3/8 WITH VIBRA SEAL
93	030340	12"	HOSE ¼ ID	146	070185	1	FILTER, OIL D 69 X 64 LONG
94	0D5282	1	GASKET, MANIFOLD TO CARBURETOR	147	0C7292	1	NIPPLE, 3/4"-16 UNF
95	086061G	1	SLEEVING 1/2" I.D.	148	0D3083	1	ASSEMBLY, OIL DRAIN HOSE
96	0D6313	1	FILTER, FUEL	149	0C3025	1	SWITCH, OIL PRESS
97	070008	4	WASHER FLAT M8	150	0D4550	1	BRACKET, AIRBOX SUPPORT
98	070006	4	WASHER LOCK M8	151	0C3018	1	WRAPPER, UPPER CYLINDER 1
99	049821	4	SCREW SHC M8-1.25 X 30	152	0C3019	1	WRAPPER, LOWER CYLINDER 1
100	0C9911	1	MANIFOLD, INTAKE	153	046964	1	BRASS ST ELBOW 1/4 NPT
101	051714	3	NUT HEX M3-0.5	154	0D5605	1	ROD,GOV. STEP MOTOR-CARBURETOR
102	0D5411	1	ROD, SUMMER / WINTER VALVE	155	0D6341	2	ROD END
103	0D5445	1	BUSHING, MINI CONTROL PANEL	156	0D6342	2	BALL STUD
104	0D5416	1	KNOB, CONTROL SUMMER / WINTER	157	0D9784	2	NUT LOCK HEX M3-0.5
105	0D5398	1	CHOKE ASSEMBLY	158	031879	1	WASHER FLAT #4
106	066849	2	SCREW TAPTITE M5-0.8 X 8 BP				
107	0D3432	1	PANEL, CONTROL FACE PLATE				
108	045756	26	SCREW TAPTITE M6-1.0X 10 YELLOW CHROME				
109	0D4767	1	SWITCH ROCKER				
110	0D1142A	1	WRAPPER, LOWER CYLINDER 2				
111	0D1143	1	WRAPPER, UPPER CYLINDER 2				
112	0C3053	1	ASSEMBLY, GROUND WIRE				
113	022097	4	WASHER LOCK M6-1/4				
114	092079	4	SCREW TAPTITE M6-1.0 X 25 BP				
115	0C3052	2	ASSEMBLY, IGNITION COIL				
116	0C4147	1	PUMP, IMPULSE				
117	022264	2	WASHER LOCK M4				

Section 7 — Exploded Views and Parts Lists

**Commercial-Industrial-Residential Portable Generator System
Generator – Drawing No. 0D4488**

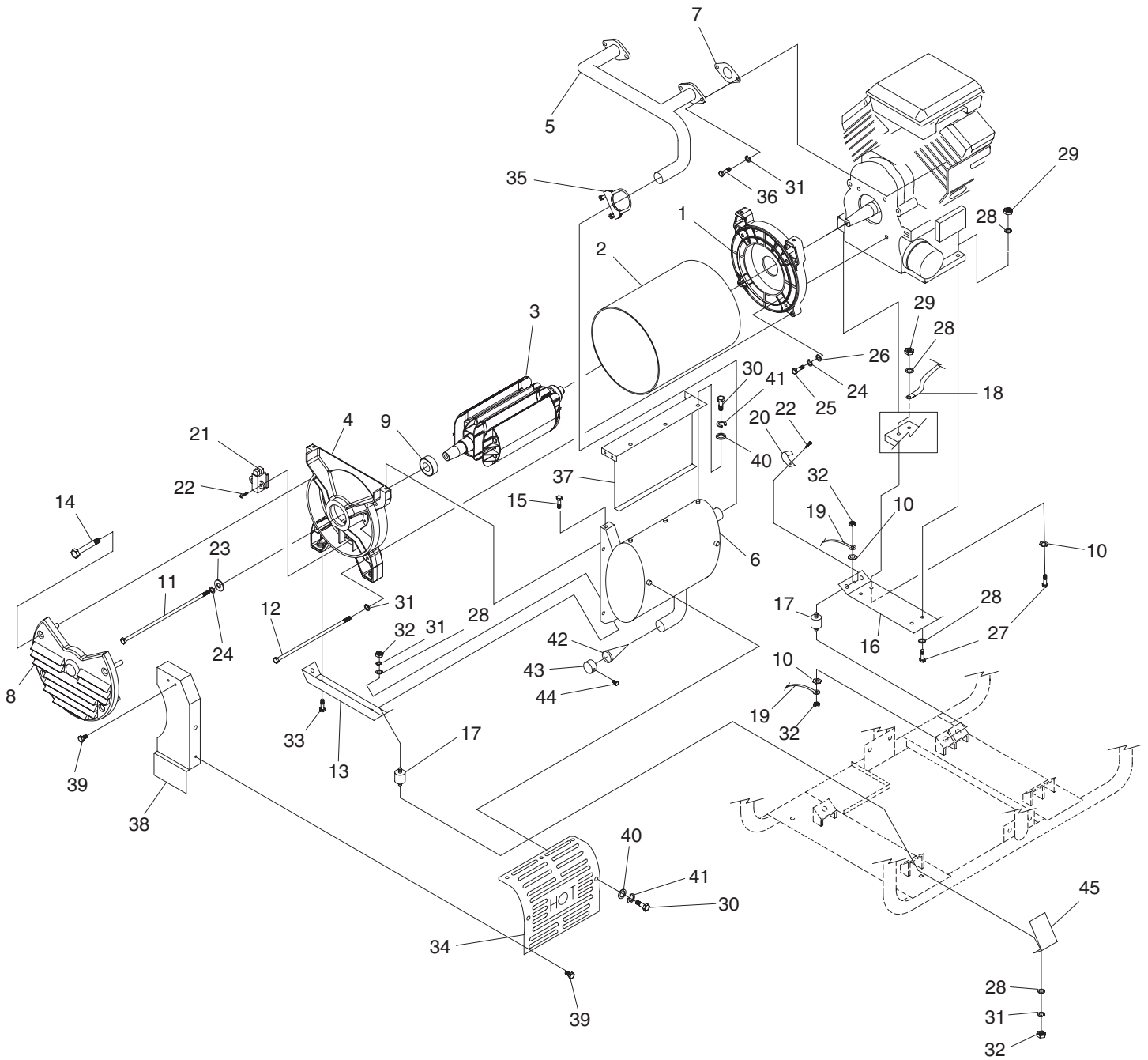

Section 7 — Exploded Views and Parts Lists

**Commercial-Industrial-Residential Portable Generator System
Generator – Drawing No. 0D4488**

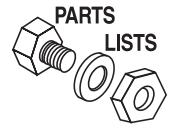

ITEM	PART NO.	QTY.	DESCRIPTION	ITEM	PART NO.	QTY.	DESCRIPTION
1	0C6934	1	ADAPTOR, ENGINE	23	0A2038	1	WASHER FLAT 3/8 ZINC
2	0D2123	1	STATOR 12.5KW	24	022237	5	WASHER LOCK 3/8
	0D2134		STATOR 15KW	25	022511	4	SCREW HHC 3/8-16 X 1-1/4 G5
3	0D2132	1	ROTOR 12.5KW	26	022131	4	WASHER FLAT 3/8-M10 ZINC
	0D2133		ROTOR 15KW	27	039288	4	SCREW HHC M8-1.25 X 55 G8.8
4	0C6043B	1	CARRIER, REAR BEARING	28	022145	22	WASHER FLAT 5/16 ZINC
5	0D2492	1	EXHAUST MANIFOLD	29	049820	4	NUT LOCK HEX M8-1.25 NYLON INSERT
6	0D2726	1	MUFFLER	30	043116	5	SCREW HHC M6-1.0 X 12
7	0C4138	2	GASKET, EXHAUST	31	022129	18	WASHER LOCK M8-5/16
8	0D3547	1	COVER, ALTERNATOR AIR IN	32	022259	12	NUT HEX 5/16-18 STEEL
9	031971	1	BEARING	33	059637	2	SCREW TAPTITE 3/8-16 X 3/4 BP
10	0C3168	3	5/16 SPECIAL LOCK WASHER	34	0D5100	1	SHIELD, MUFFLER HEAT
11	0D1838	1	SCREW IHHC 3/8-24 X 15.50 G5	35	0D5823	1	U-BOLT & SADDLE
12	0D3549	4	SCREW IHHC M8-1.25 X 400 G8.8	36	0C8565	4	SCREW SHC M8-1.25 X 18
13	0C7038E	1	BRACKET, ALT MOUNTING	37	0D5833	1	PANEL, MUFFLER BOX BACK
14	032712	4	SCREW HHTT #10-32 X 1.75	38	0D5834	1	PANEL, MUFFLER BOX END
15	083512	1	SCREW TAPTITE M8-1.25 X 16 BP	39	090388	3	SCREW HHTT M6-1.0 X 12
16	0C7038D	1	ENGINE MOUNTING PLATE	40	022473	5	WASHER FLAT 1/4
17	0C7758	6	RUBBER MOUNT	41	022097	5	WASHER LOCK M6-1/4
18	0388050AF0	1	BATTERY CABLE, BLACK	42	0D5133	1	SPARK ARRESTOR SCREEN
19	0C2417A	1	EARTH STRAP 3/8X 3/8	43	0D5133A	1	RETAINER, SPARK ARREST SCREEN
20	082121C	1	CLIP-J VINYL COAT .625 ID	44	045764	1	SCREW HHTT M4-0.7 X 8
21	066386	1	ASSEMBLY, BRUSH HOLDER	45	0D6214	1	SHIELD, RUBBER MOUNT
22	0C2824	3	SCREW TAP-R #10-32 X 9/16				

Section 7 — Exploded Views and Parts Lists

Commercial-Industrial-Residential Portable Generator System
Control Panel – Drawing No. 0E0227

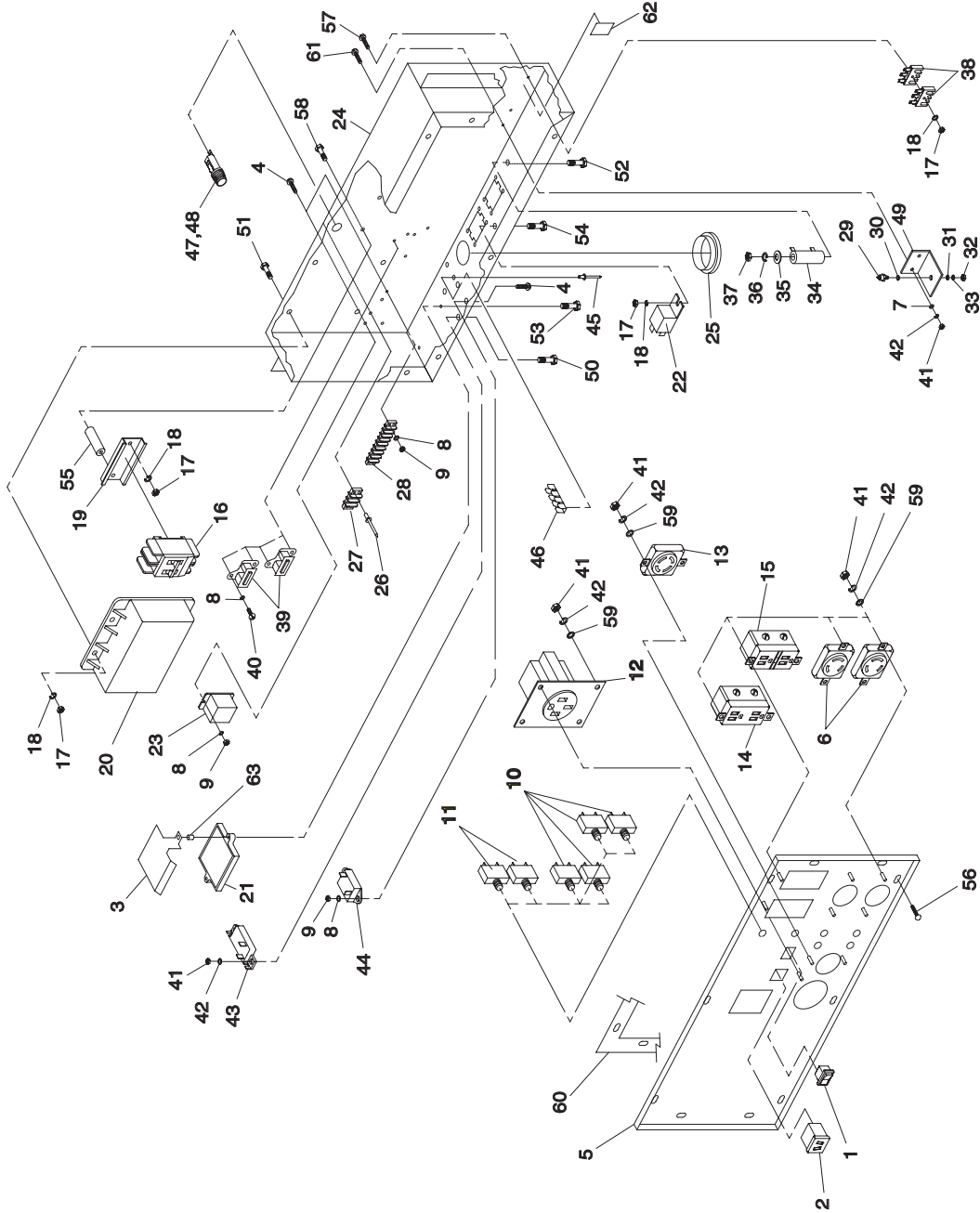

Section 7 — Exploded Views and Parts Lists
Commercial-Industrial-Residential Portable Generator System
Control Panel – Drawing No. 0E0227

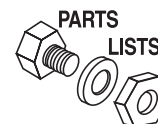

ITEM	PART NO.	QTY.	DESCRIPTION	ITEM	PART NO.	QTY.	DESCRIPTION
1	087968	1	SWITCH, ROCKER -/0	32	022158	1	NUT HEX #10-32
2	090418	1	OUTLET, 12VDC SNAP	33	023897	1	WASHER FLAT #10
3	0D6640	1	COVER, GOVERNOR CONTROL	34	057405	1	RESISTOR 25R 5% 25W
4	090987	6	SCREW PPHM M3-0.5 X 12	35	022473	1	WASHER FLAT 1/4
5	0D2502	1	PANEL, SHEET METAL	36	022097	1	WASHER LOCK M6-1/4
6	068868	2	OUTLET 30A 120V RECEP	37	049813	1	NUT HEX M6-1.0 G8
7	022985	2	WASHER FLAT #6	38	065795	2	RECTIFIER-BATTERY CHARGER
8	043182	10	WASHER LOCK M3	39	0D4804	2	TRANSFORMER, IDLE CURRENT
9	051714	6	NUT HEX M3-0.5 G8	40	0C1085	4	SCREW PPHM M3-0.5 X 8
10	075207A	4	CIRCUIT BREAKER 30A	41	051715	18	NUT HEX M4-0.7 G8
11	075207	2	CIRCUIT BREAKER 20A	42	022264	18	WASHER LOCK M4
12	0D4969	1	OUTLET 50A 125/250V	43	048512	1	CIRCUIT BREAKER 5 X 1
13	043437	1	OUTLET 30A 125/250V	44	087962	1	CIRCUIT BREAKER 10 X 1 12VDC 1/4"QC
14	0D4968	1	OUTLET 20A 120V DPLX	45	036261	2	RIVET POP .125 X .129-.133 / #30
15	0D4966	1	OUTLET 20A 120V GFCI	46	0A2769	1	LUG GRND 8 TABS
16	0D1004E	1	CIRCUIT BREAKER 50A 400V 2POLE	47	032300	1	HOLDER FUSE
17	051716	8	NUT HEX M5-0.8 G8	48	028578	1	FUSE 10A X AGC10
18	022152	8	WASHER LOCK #10	49	055444	1	HEATSINK
19	0D5045	1	DIN RAIL 59.5mm LONG	50	075475	2	SCREW PPHM M4-0.7 X 10
20	067680	1	ASSEMBLY VOLTAGE REGULATOR 60HZ	51	049815	4	SCREW HHC M5-0.8 X 16 G8.8
21	0D4409	1	ELECTRONIC GOVERNOR / IDLE CONTROLLER	52	0A2053	1	SCREW HHC M6-1.0 X 65 G8.8
22	052844	1	RELAY PNL 12VDC SPST 30A	53	055440	2	SCREW HHC M5-0.8 X 25 G8.8
23	0D4766	1	RELAY 12VDC 5A 3PDT 240V	54	045770	1	SCREW HHC M5-0.8 X 10 G8.8
24	0D2691	1	CONTROL PANEL BOX	55	0D5734	2	SPACER .25 X .50 X 1.5
25	023484L	1	BUSHING SNAP	56	074908	18	SCREW HHTT M5-0.8 X 10
26	0A1661	2	RIVET POP .156 X .160-.164 / #20	57	075235	1	SCREW PPHM M5-0.8 X 30
27	048766	1	BLOCK TERMINAL 20A 2 X 6 X 1100V	58	080823	2	SCREW PPHM M5-0.8 X 50
28	0D3550	1	BLOCK DOUBLE ROW TERMINAL 8 POSITION	59	038150	14	WASHER FLAT #8
29	049939	1	RECTIFIER MSC 12A 600V	60	0D6140	1	GASKET, PORTABLE CONTROL PANEL
30	070370	1	WASHER MICA .203	61	075476	2	SCREW PPHM M4-0.7 X 16
31	030468	1	WASHER STEP NYLON .20	62	027565	A/R	TAPE ELEC UL PERMACEL
				63	058000K	2	NUT TRIC M5-0.8

Section 7 — Exploded Views and Parts Lists

**Commercial-Industrial-Residential Portable Generator System
Frame, Handle & Wheel Kit – Drawing No. 0E0695**

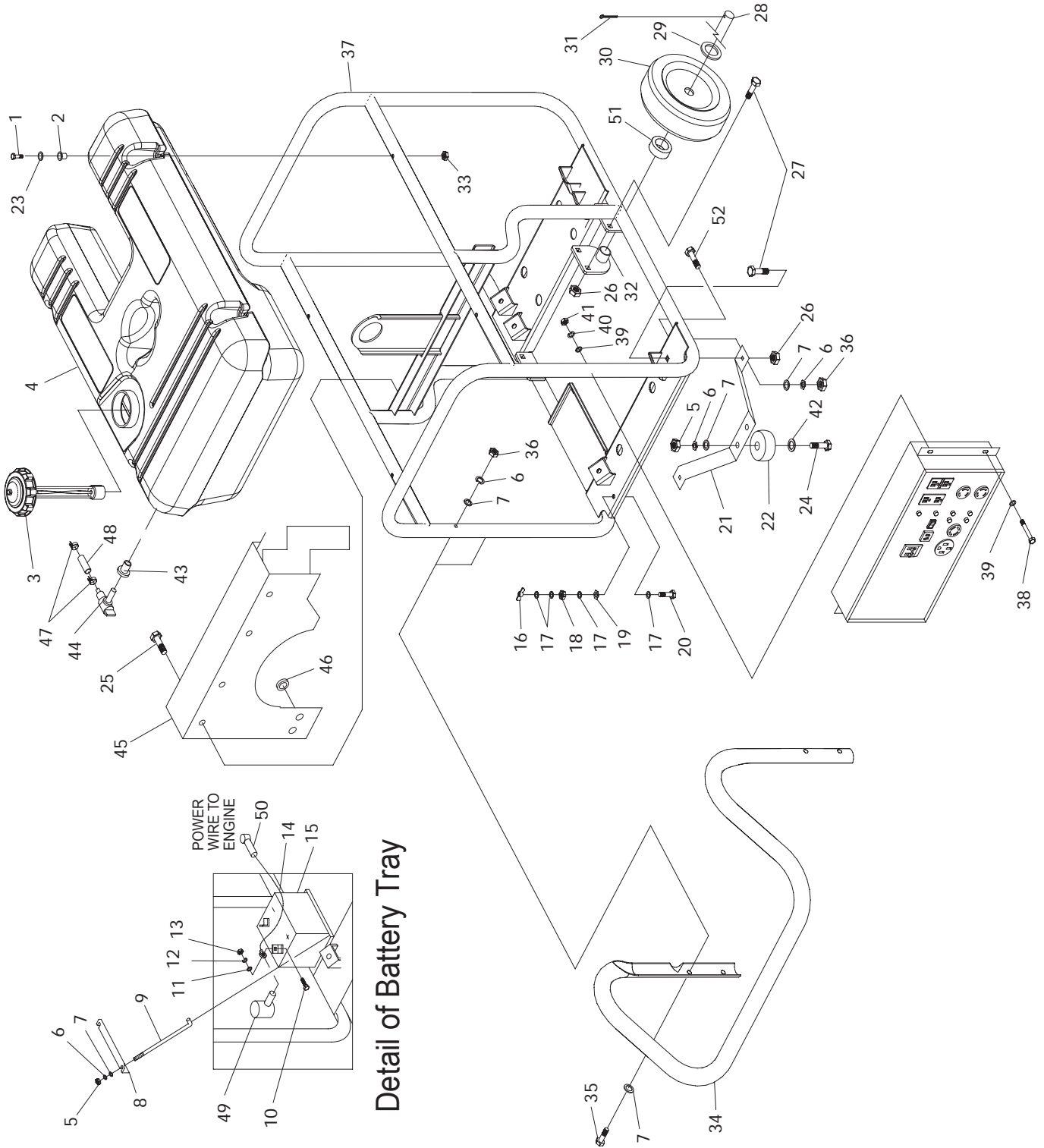

Detail of Battery Tray

Section 7 — Exploded Views and Parts Lists

Commercial-Industrial-Residential Portable Generator System
Frame, Handle & Wheel Kit – Drawing No. 0E0695

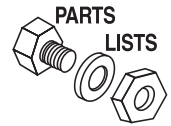

ITEM	PART NO.	QTY.	DESCRIPTION	ITEM	PART NO.	QTY.	DESCRIPTION
1	057058	4	SCREW HHC M6-1.0 X 55	28	0D9165	1	AXLE, 3/4"DIA X 30"
2	0D5315	4	RUBBER TANK MOUNT	29	045900	2	WASHER FLAT 3/4
3	0D4570	1	CAP, FUEL WITH GAUGE & VENT	30	0D7668	2	12.3" PNEUM WHEEL 3/4" AXLE
4	0D22850SRV	1	KIT, FUEL TANK	31	0D4999	2	PIN COTTER 1/8 X 1-1/4
5	045771	4	NUT HEX M8-1.25	32	0D4044	2	BRACKET, WHEEL SPACER
6	022129	10	WASHER LOCK M8-5/16	33	0D3700	4	NUT FLANGE M6-1.0 NYLON
7	022145	14	WASHER FLAT 5/16	34	0D2497	1	HANDLE
8	0D4565	1	BRACKET BATTERY	35	022532	4	SCREW HHC 5/16-18 X 2-1/2 G5
9	0D3545	2	BOLT,BATTERY J-BOLT	36	027028	6	NUT LOCK HEX 5/16-18 NYLON INSERT
10	022287	2	SCREW HHC 1/4-20 X 3/4 G5	37	0D2271	1	FRAME
11	022473	2	WASHER FLAT 1/4	38	052762	4	SCREW HHC M5-0.8 X 45 G8.8
12	022097	2	WASHER LOCK M6-1/4	39	051713	8	WASHER FLAT M5
13	022127	2	NUT HEX 1/4-20	40	049226	4	WASHER LOCK M5
14	0388040AK0	1	BATTERY CABLE, RED	41	051716	4	NUT HEX M5-0.8
15	0D4575	1	BATTERY U1	42	050190	2	WASHER FLAT 1"
16	0D5202	1	NUT WING 5/16-18 BRASS	43	078299	1	BUSHING TANK DEXTOR
17	0D5199	4	WASHER FLAT 5/16 BRASS	44	080270	1	VALVE, PLASTIC TANK
18	029809	1	NUT HEX 5/16-18 BRASS	45	0D5142	1	AIR DEFLECTOR
19	0C3168	1	5/16 SPECIAL L/WASH	46	096021	2	GROMMET .75 X .06 X .50
20	0D5198	1	SCREW HHC 5/16-18 X 1.5 BRASS	47	048031C	2	CLAMP HOSE BAND ¼
21	0E0317	1	BRACKET FRONT FOOT	48	030340	18"	HOSE ¼ ID
22	027007	2	VIB MOUNT	49	075763	1	BOOT BATTERY CABLE
23	0D5303	4	WASHER FLAT .25ID X 1"OD	50	075763A	1	BOOT STARTER CABLE
24	042909	2	SCREW HHC M8-1.25 X 30	51	0E0318	2	SPACER, AXLE
25	090388	4	SCREW HHTT M6-1.0 X 12	52	030795	2	SCREW HHC 5/16"-18 X 1"
26	064101	6	NUT LOCK FL 3/8-16				
27	039214	6	BOLT CARR 3/8-16 X 1				



CALIFORNIA EMISSION CONTROL WARRANTY STATEMENT

YOUR WARRANTY RIGHTS AND OBLIGATIONS

The California Air Resources Board (CARB) and Generac Power Systems, Inc. (Generac) are pleased to explain the Emission Control System warranty on your new engine. In California, new off-road Large Spark-Ignition (LSI) engines must be designed, built and equipped to meet the state's stringent anti-smog standards. Generac will warrant the emission control system on your engine one for the periods of time listed below provided there has been no abuse, neglect, unapproved modification or improper maintenance of your engine.

Your emission control system may include parts such as the carburetor, ignition system and exhaust system. Generac will repair your engine at no cost to you for diagnosis, replacement parts and labor, should a warrantable condition occur.

MANUFACTURER'S EMISSION CONTROL SYSTEM WARRANTY COVERAGE:

Emissions control systems on 2001 and later model year LSI engines are warranted for two years as hereinafter noted- If, during such warranty period, any emission-related component or system on your engine is found to be defective in materials or workmanship, repairs or replacement will be performed by a Generac Authorized Warranty Service Facility.

PURCHASER'S/OWNER'S WARRANTY RESPONSIBILITIES:

As the engine owner, you are responsible for the completion of all required maintenance as listed in your factory supplied Owner's Manual. For warranty purposes, Generac recommends that you retain all receipts covering maintenance on your engine. However, Generac cannot deny warranty solely due to the lack of receipts or for your failure to ensure the completion of all scheduled maintenance.

As the engine purchaser/owner, you should, however, be aware that Generac may deny any and/or all warranty coverage or responsibility if your engine, or a part/component thereof, has failed due to abuse, neglect, improper maintenance or unapproved modifications, or the use of counterfeit and/or "grey market" parts not made, supplied or approved by Generac.

You are responsible for contacting a Generac Authorized Warranty Facility as soon as a problem occurs. The warranty repairs should be completed in a reasonable amount of time, not to exceed 30 days.

Warranty service can be arranged by contacting either your selling dealer or a Generac Authorized Warranty Service Facility. To locate the Generac Authorized Warranty Service Facility nearest you, call our toll free number:

1-800-333-1322

IMPORTANT NOTE: This warranty statement explains your rights and obligations under the Emission Control System Warranty (ECS Warranty), which is provided to you by Generac pursuant to California law. See also the "Generac Limited Warranties for Generac Power Systems, Inc.," which is enclosed herewith on a separate sheet, also provided to you by Generac. The ECS Warranty applies **only** to the emission control system of your new engine. If there is any conflict in terms between the ECS Warranty and the Generac Warranty, the ECS warranty shall apply except in circumstances where the Generac Warranty may provide a longer warranty period. Both the ECS Warranty and the Generac Warranty describe important rights and obligations with respect to your new engine.

Warranty service can be performed only by a Generac Authorized Warranty Service Facility. When requesting warranty service, evidence must be presented showing the date of the sale to the original purchaser/owner.

If you have any questions regarding your warranty rights and responsibilities, you should contact Generac at one of the following addresses:

**ATTENTION WARRANTY DEPARTMENT
GENERAC POWER SYSTEMS, INC.
P.O. BOX 297 • WHITEWATER, WI 53190**



EMISSION CONTROL SYSTEM WARRANTY

Emission Control System Warranty (ECS warranty) for 2001 and later model year LSI engines:

- (a) Applicability: This warranty shall apply to 1995 and later model year engines. The ECS Warranty period shall begin on the date the new engine or equipment is purchased by/delivered to its original, end-use purchaser/owner and shall continue for 24 consecutive months thereafter.
- (b) General Emissions Warranty Coverage: Generac warrants to the original, end-use purchaser/owner of the new engine or equipment and to each subsequent purchaser/owner that each of its engines is...
 - (1) Designed, built and equipped so as to conform with all applicable regulations adopted by the CARB pursuant to its authority, and
 - (2) Free from defects in materials and workmanship which, at any time during the ECS Warranty Period, may cause a warranted emissions-related part to fail to be identical in all material respects to the part as described in the engine manufacturer's application for certification.

The ECS Warranty pertains only to emissions-related parts on your engine, as follows:

- (1) Any warranted, emissions-related parts that are not scheduled for replacement as required maintenance in the *Owner's Manual* shall be warranted for the ECS Warranty Period. If any such part fails during the ECS Warranty Period, it shall be repaired or replaced by Generac according to Subsection (4) below. Any such part repaired or replaced under the ECS Warranty shall be warranted for the remainder of the ECS Warranty Period.
- (2) Any warranted, emissions-related part that is scheduled only for regular inspection as specified in the *Owner's Manual* shall be warranted for the ECS Warranty Period. A statement in such written instructions to the effect of "repair or replace as necessary" shall not reduce the ECS Warranty Period. Any such part repaired or replaced under the ECS Warranty shall be warranted for the remainder of the ECS Warranty Period.
- (3) Any warranted, emissions-related part that is scheduled for replacement as required maintenance in the *Owner's Manual* shall be warranted for the period of time prior to first scheduled replacement point for that part. If the part fails prior to the first scheduled replacement, the part shall be repaired or replaced by Generac according to Subsection (4) below. Any such emissions-related part repaired or replaced under the ECS warranty shall be warranted for the remainder of the ECS Warranty Period prior to the first scheduled replacement point for such emissions-related part.
- (4) Repair or replacement of any warranted, emissions-related part under this ECS Warranty shall be performed at no charge to the owner at a Generac Authorized Warranty Service Facility.
- (5) When the engine is inspected by a Generac Authorized Warranty Service Facility, the purchaser/owner shall not be held responsible for diagnostic costs if the repair is deemed warrantable.
- (6) Generac shall be liable for damages to other original engine components or approved modifications caused by a failure under warranty of any emission-related part covered by the ECS Warranty.
- (7) Throughout the ECS Warranty Period, Generac shall maintain a supply of warranted emission-related parts sufficient to meet the expected demand for such emission-related parts.
- (8) Any Generac authorized and approved emission-related replacement part may be used in the performance of any ECS warranty maintenance or repairs and will be provided without charge to the purchaser/owner. Such use shall not reduce Generac RCS Warranty obligations.
- (9) Unapproved, add-on, modified, counterfeit and/or "grey market" parts may not be used to modify or repair a Generac engine. Such use voids this ECS Warranty and shall be sufficient grounds for disallowing an ECS Warranty claim. Generac shall not be held liable hereunder for failures of any warranted parts of a Generac engine caused by the use of such an unapproved, add-on, modified, counterfeit and/or "grey market" part.

EMISSION RELATED PARTS INCLUDE THE FOLLOWING:

- | | |
|---|---|
| <ul style="list-style-type: none"> 1) Fuel Metering System: <ul style="list-style-type: none"> 1.2) LPG/Natural Gas carburetion assembly and its internal components. <ul style="list-style-type: none"> a) Fuel controller (if so equipped) b) Mixer and its gaskets (if so equipped) c) Carburetor and its gaskets (if so equipped) d) Primary gas regulator (if so equipped) e) LP liquid vaporizer (if so equipped) 2) Air Induction System including: <ul style="list-style-type: none"> a) Intake pipe/manifold b) Air cleaner | <ul style="list-style-type: none"> 3) Ignition System including: <ul style="list-style-type: none"> a) Spark plug b) Ignition module 4) Catalytic Muffler Assembly (if so equipped) including: <ul style="list-style-type: none"> a) Muffler gasket b) Exhaust manifold 5) Crankcase Breather Assembly including: <ul style="list-style-type: none"> a) Breather connection tube |
|---|---|

* Generac engine types covered by this warranty statement include the following:

- 1) Prepackaged Standby Generator
- 2) Auxiliary Power Unit (APU) Generator
- 3) Standby Generator



Section 8 – Warranty

Commercial-Industrial-Residential Portable Generator System

GENERAC POWER SYSTEMS “TWO YEAR” LIMITED WARRANTY FOR GUARDIAN® “12,500 WATT AND 15,000 WATT PORTABLE GENERATORS”

For a period of two years from the date of original sale, Generac Power Systems, Inc. (Generac) warrants its Guardian generator will be free from defects in materials and workmanship for the items and period set forth below. Generac will, at its option, repair or replace any part which, upon examination, inspection and testing by Generac or a Generac Authorized Warranty Service Dealer, is found to be defective. Any equipment that the purchaser/owner claims to be defective must be returned to and examined by the nearest Generac Authorized Warranty Service Dealer. All transportation costs under the warranty, including return to the factory, are to be borne and prepaid by the purchaser/owner. This warranty applies only to Generac Guardian portable generators and is not transferable.

WARRANTY SCHEDULE

Consumer applications are warranted for 2 (two) years. Commercial applications are warranted for 1 (one) year. Rental applications are warranted for 90 (ninety) days.

CONSUMER APPLICATION

YEARS ONE and TWO - 100% (one hundred percent) coverage on Labor and Part(s) listed (proof of purchase and maintenance is required):

- **Engine** - All Components
- **Alternator** - All Components

NOTE: For the purpose of this warranty "consumer use" means personal residential household use by original purchaser. This does not apply to units used for Prime Power in place of utility where utility power service normally exists. Once a generator has experienced commercial or rental use, it shall thereafter be considered a non-consumer use generator for the purpose of this warranty.

All warranty expense allowances are subject to the conditions defined in Generac's Warranty Policies, Procedures and Flat Rate Manual.

THIS WARRANTY SHALL NOT APPLY TO THE FOLLOWING:

- **Generac Guardian portable generators that utilize non-Generac replacement parts.**
- Costs of normal maintenance and adjustments.
- Failures caused by any contaminated fuels, oils or lack of proper oil levels.
- Failures due, but not limited, to normal wear and tear, accident, misuse, abuse, negligence or improper use. As with all mechanical devices, the Generac engines need periodic part(s) service and replacement to perform well. This warranty will not cover repair when normal use has exhausted the life of a part(s) or engine.
- Failures caused by any external cause or act of God, such as collision, theft, vandalism, riot or wars, nuclear holocaust, fire, freezing, lightning, earthquake, windstorm, hail, volcanic eruption, water or flood, tornado or hurricane.
- Damage related to rodent infestation.
- Products that are modified or altered in a manner not authorized by Generac in writing.
- Any incidental, consequential or indirect damages caused by defects in materials or workmanship, or any delay in repair or replacement of the defective part(s).
- Failure due to misapplication.
- Telephone, cellular phone, facsimile, internet access or other communication expenses.
- Living or travel expenses of person(s) performing service, except as specifically included within the terms of a specific unit warranty period.
- Expenses related to "customer instruction" or troubleshooting where no manufacturing defect is found.
- Rental equipment used while warranty repairs are being performed.
- Overnight freight costs for replacement part(s).
- Overtime labor.
- Starting batteries, fuses, light bulbs and engine fluids.

THIS WARRANTY IS IN PLACE OF ALL OTHER WARRANTIES, EXPRESSED OR IMPLIED. SPECIFICALLY, GENERAC MAKES NO OTHER WARRANTIES AS TO THE MERCHANTABILITY OR FITNESS FOR A PARTICULAR PURPOSE. Some states do not allow limitations on how long an implied warranty lasts, so the above limitation may not apply to you.

GENERAC'S ONLY LIABILITY SHALL BE THE REPAIR OR REPLACEMENT OF PART(S) AS STATED ABOVE. IN NO EVENT SHALL GENERAC BE LIABLE FOR ANY INCIDENTAL OR CONSEQUENTIAL DAMAGES, EVEN IF SUCH DAMAGES ARE A DIRECT RESULT OF GENERAC'S NEGLIGENCE. Some states do not allow the exclusion or limitation of incidental or consequential damages, so the above limitation may not apply to you.

This warranty gives you specific legal rights. You also have other rights from state to state.

GENERAC® POWER SYSTEMS, INC.
P.O. BOX 297 • WHITEWATER, WI 53190

Free Manuals Download Website

<http://myh66.com>

<http://usermanuals.us>

<http://www.somanuals.com>

<http://www.4manuals.cc>

<http://www.manual-lib.com>

<http://www.404manual.com>

<http://www.luxmanual.com>

<http://aubethermostatmanual.com>

Golf course search by state

<http://golfingnear.com>

Email search by domain

<http://emailbydomain.com>

Auto manuals search

<http://auto.somanuals.com>

TV manuals search

<http://tv.somanuals.com>