

# GENERAC

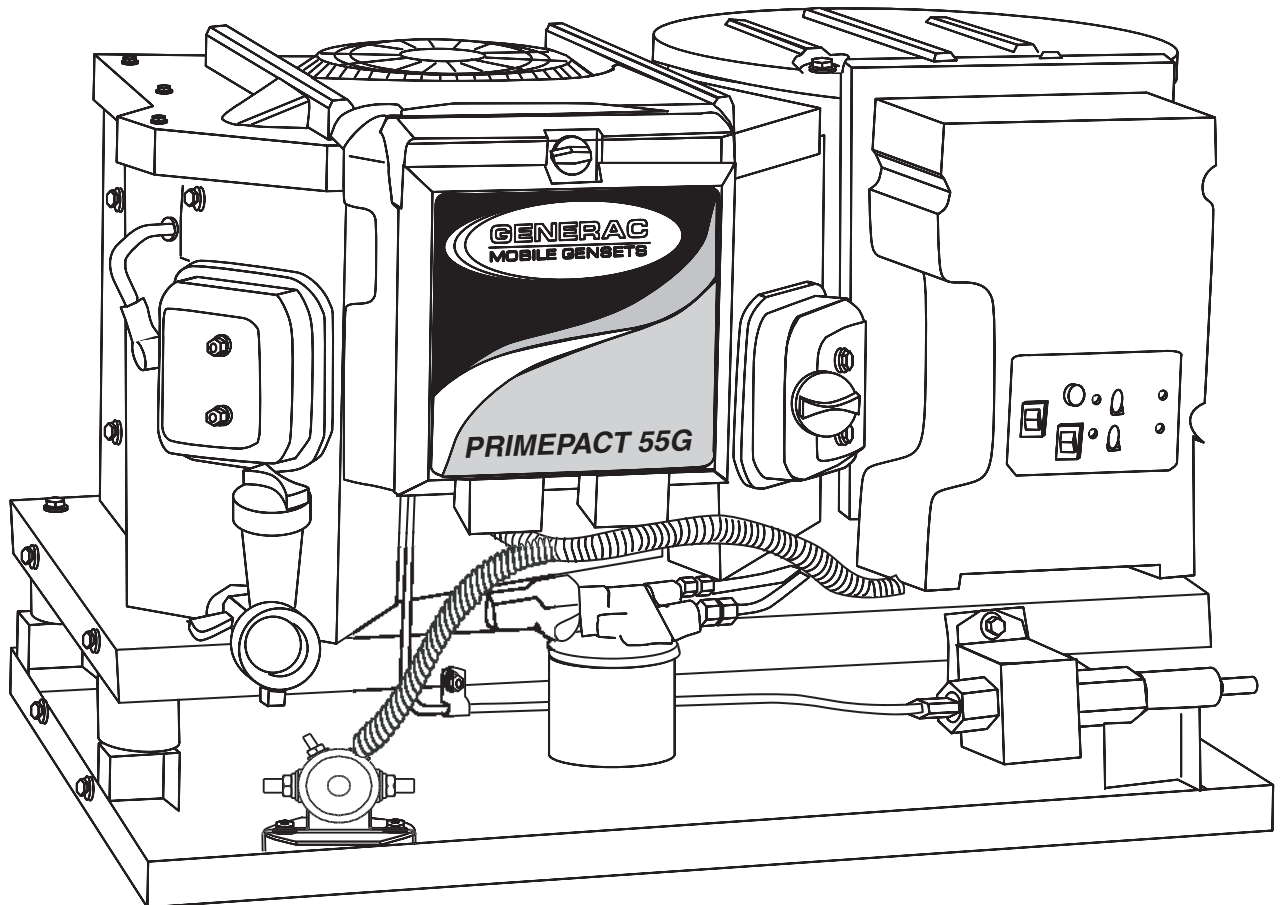

# INTRODUCTION

## ◆ READ THIS MANUAL THOROUGHLY

If you do not understand any portion of this manual, contact Generac or your nearest Generac Authorized Service Dealer for starting, operating and servicing procedures.

Throughout this publication, and on tags and decals affixed to the generator, DANGER, WARNING, CAUTION and NOTE blocks are used to alert you to special instruction about a particular operation that may be hazardous if performed incorrectly or carelessly. Observe them carefully. Their definitions are as follows:



After this heading, you can read instructions that, if not strictly complied with, will result in personal injury or property damage.



After this heading, you can read instructions that, if not strictly complied with, may result in personal injury or property damage.



After this heading, you can read instructions that, if not strictly complied with, could result in damage to equipment and/or property.

### NOTE:

After this heading, you can read explanatory statements that require special emphasis.

These safety warnings cannot eliminate the hazards that they indicate. Common sense and strict compliance with the special instructions while performing the service are essential to preventing accidents.

Four commonly used safety symbols accompany the Danger, Warning and Caution blocks. The type of information each indicates follows:

 This symbol points out important safety information that, if not followed, could endanger personal safety and/or property of you and others.

 This symbol points out potential explosion hazard.

 This symbol points out potential fire hazard.

 This symbol points out potential electrical shock hazard.

The operator (driver) is responsible for proper and safe use of the vehicle and its equipment, and the safety of all vehicle occupants. We strongly recommend that the operator read this manual and thoroughly understand all instructions before using this equipment. We also strongly recommend instructing other occupants in the vehicle to properly start and operate the generator. This prepares them if they need to operate the equipment in an emergency.

## ◆ CONTENTS

This manual contains pertinent owner's information, including warranty, electrical diagrams, exploded views and lists of repair parts for generator model numbers 009592-5 and 009735-5. In addition, the latter portion of this manual contains information necessary for the proper installation of these generators.

## ◆ OPERATION AND MAINTENANCE

It is the operator's responsibility to perform all safety checks, to make sure that all maintenance for safe operation is performed promptly, and to have the equipment checked periodically by a Generac Authorized Service Dealer. Normal maintenance service and replacement of parts are the responsibility of the owner/operator and, as such, are not considered defects in materials or workmanship within the terms of the warranty. Individual operating habits and usage contribute to the need for maintenance service.

Proper maintenance and care of your generator ensure a minimum number of problems and keep operating expenses at a minimum. See your Generac Authorized Service Dealer for service aids and accessories.

## ◆ HOW TO OBTAIN SERVICE

When your generator requires servicing or repairs, simply contact a Generac Authorized Service Dealer for assistance. Service technicians are factory-trained and are capable of handling all of your service needs.

When contacting a Generac Authorized Service Dealer or the factory about parts and service, always supply the complete model number and serial number of your unit as given on its data decal, which is located on your generator.

Model No. \_\_\_\_\_ Serial No. \_\_\_\_\_

### AUTHORIZED SERVICE DEALER LOCATION

To locate the GENERAC AUTHORIZED SERVICE DEALER nearest you, please call this number:

**1-800-333-1322**

ONLY DEALER LOCATION INFORMATION CAN BE OBTAINED AT THIS NUMBER.

**Part I – Operating Instructions****Introduction.....Inside Front Cover**

Read This Manual Thoroughly .....	IFC
Contents .....	IFC
Operation and Maintenance .....	IFC
How to Obtain Service .....	IFC
Authorized Service Dealer Locator Number .....	IFC

**Safety Rules.....2****Section 1 – General Information .....4**

1.1 Generator Identification .....	4
1.2 Generator Applicability .....	5
1.3 Installation .....	5
1.4 Safety .....	5
1.5 Generator AC Connection System .....	5
1.6 Specifications .....	6
1.6.1 Fuel Requirements .....	6
1.6.2 Engine Oil Requirements .....	6
1.6.3 Engine Specifications .....	6
1.6.4 Emissions Compliance Period .....	6
1.6.5 Generator Specifications.....	6

**Section 2 – Operation.....7**

2.1 Generator Control Panel .....	7
2.1.1 Fuel Primer .....	7
2.1.2 Start/Stop Switch .....	7
2.1.3 15 Amp Fuse.....	7
2.1.4 Line Breakers .....	7
2.2 Optional Remote Start/Stop Panel.....	7
2.3 Automatic Choke .....	7
2.3.1 Choke Solenoid .....	7
2.3.2 Prechoke.....	8
2.4 Before Starting the Engine .....	8
2.4.1 Installation.....	8
2.4.2 Engine Lubrication .....	8
2.4.3 Fuel Supply .....	8
2.4.4 Cooling and Ventilating Air .....	8
2.4.5 Engine Exhaust Gas .....	8
2.5 Starting the Generator .....	8
2.6 Stopping the Generator.....	9
2.7 Applying Loads to Generator .....	9
2.7.1 Letting the Engine Stabilize .....	9
2.7.2 Do Not Overload the Generator .....	9
2.8 Protection Systems .....	9
2.8.1 Low Oil Pressure Switch.....	9
2.8.2 High Temperature Switch .....	10
2.8.3 Field Boost .....	10
2.8.4 Overvoltage Protection .....	10
2.8.5 25-Hour Break-in Period.....	10
2.8.6 25-Hour Checkup .....	11
2.8.7 Operation in High Grass or Brush .....	11

**Section 3 – Maintenance .....11**

3.1 Checking the Engine Oil Level.....	11
3.2 Changing the Engine Oil and/or Oil Filter .....	11
3.3 Maintaining the Engine Air Cleaner .....	12
3.3.1 Cleaning the Foam Precleaner.....	12
3.4 Clean Air Intake Screen .....	12
3.5 Checking the Engine Spark Plug.....	12
3.6 Fuel Filter (Gasoline Only) .....	13
3.7 Spark Arrestor Muffler .....	13
3.8 Cleaning the Generator .....	13
3.9 Battery Maintenance .....	13
3.9.1 Weekly .....	13
3.9.2 Every Six Months .....	13
3.10 Major Service Manual .....	14
3.11 Drive Belt .....	14
3.12 Exercising the Generator .....	14
3.13 Out of Service Procedure .....	14
3.13.1 Removal From Service .....	14
3.13.2 Return to Service .....	15
3.14 Wattage Reference Guide.....	15

**Section 4 – Notes.....16****Part II – Installation Instructions****Safety Rules.....18-19****Section 5 – General Information.....20**

5.1 Purpose and Scope of the Manual.....	20
5.2 Safety .....	20
5.3 Standard Booklets .....	20
5.4 Equipment Description .....	20
5.5 Generator Engine Operating Speed.....	20
5.6 Generator AC Connection System .....	20
Major Dimensions and Features .....	21

**Section 6 – Installation .....22**

6.1 Location and Support .....	22
6.1.1 Generator Location.....	22
6.1.2 Generator Supports .....	22
6.1.3 Suspended Mounting .....	22
6.1.4 Generator Restraint .....	23
6.2 Generator Compartments .....	23
6.2.1 Compartment Size .....	23
6.2.2 Compartment Construction .....	23
6.2.3 Sound Insulating Materials.....	24
6.2.4 Acoustics .....	24
6.2.5 Compartment Floor Cutouts.....	25
6.3 Cooling and Ventilation .....	26
6.3.1 Generator Airflow .....	26
6.3.2 Cooling Air Inlet Openings .....	26
6.3.3 Compensating for Restrictions .....	27
6.3.4 Testing the Installation .....	27
6.4 Gasoline Fuel System .....	27
6.4.1 Fuel Tank .....	28
6.4.2 Generator Fuel Supply Line .....	28
6.4.2.1 Rigid Fuel Lines.....	28
6.4.2.2 Flexible Fuel Lines.....	28
6.5 LP Gas Fuel System .....	28
6.5.1 Parts not included in Fuel System .....	28
6.5.2 Some Important Considerations.....	29
6.5.3 Vapor Withdrawal .....	29
6.5.4 Primary Regulator.....	29
6.5.5 Gaseous Carburetion .....	29
6.5.6 Fuel Supply Lines .....	30
6.5.7 Excess Flow Valve.....	30
6.5.8 Leakage Tests .....	30
6.6 Exhaust Systems.....	30
6.6.1 Mufflers and Spark Arrestors.....	31
6.6.2 Type of Exhaust System .....	31
6.6.3 Exhaust System Safety .....	31
6.7 Electrical Connections .....	31
6.7.1 Electrical Junction Box .....	31
6.7.2 Wiring.....	32
6.7.3 Generator AC Connections .....	32
6.7.4 Conduit.....	32
6.7.5 Isolating Different Power Sources .....	32
6.7.6 Power Supply Cord.....	33
6.7.7 Ground Fault Circuit Interrupters .....	33
6.8 Battery Installation .....	34
6.8.1 Recommended Battery .....	34
6.8.2 Battery Cables .....	34
6.8.3 Battery Cable Connections .....	34
6.8.4 Battery Compartment .....	34
6.9 Optional Accessories.....	34
6.9.1 Remote Panel Models .....	35

**Section 7 – Post Installation .....35**

7.1 Post Installation Tests .....	35
7.2 Before Initial Start-up .....	35
7.3 Initial Start .....	35
7.4 Testing Under Load.....	35
7.5 Installation Checklist .....	36

**Section 8 – Troubleshooting .....37**

8.1 Troubleshooting Guide .....	37
---------------------------------	----

**Section 9 – Electrical Data.....38****Section 10 – Exploded Views and Parts Lists.....40****Section 11 – Notes.....53****Section 12 – Warranty .....56**



## Safety Rules

### PRIMEPACT 55G and 55LP Recreational Vehicle Generators

**SAVE THESE INSTRUCTIONS** – The manufacturer suggests that these rules for safe operation be copied and posted in potential hazard areas of the recreational vehicle. Safety should be stressed to all operators and potential operators of this equipment.



### WARNING:



The engine exhaust from this product contains chemicals known to the state of California to cause cancer, birth defects or other reproductive harm.



### WARNING:



This product contains or emits chemicals known to the state of California to cause cancer, birth defects or other reproductive harm.

Study these SAFETY RULES carefully before installing, operating or servicing this equipment. Become familiar with this manual and with the unit. The generator can operate safely, efficiently and reliably only if it is properly installed, operated and maintained. Many accidents are caused by failing to follow simple and fundamental rules or precautions.

Generac cannot possibly anticipate every possible circumstance that might involve a hazard. The warnings in this manual, and on tags and decals affixed to the unit, are, therefore, not all-inclusive. If you use a procedure, work method or operating technique Generac does not specifically recommend, you must satisfy yourself that it is safe for you and others. You also must make sure the procedure, work method or operating technique that you choose does not render the generator unsafe.

### — DANGER —

Despite the safe design of this generator, operating this equipment imprudently, neglecting its maintenance or being careless can cause possible injury or death. Permit only responsible and capable persons to operate or maintain this equipment.

Potentially lethal voltages are generated by these machines. Ensure all steps are taken to render the machine safe before attempting to work on the generator.

Parts of the generator are rotating and/or hot during operation. Exercise care near running generators.

### GENERAL HAZARDS

- For safety reasons, Generac recommends that the installation, initial start-up and maintenance of this equipment is carried out by a Generac Authorized Service Dealer.
- The engine exhaust fumes contain carbon monoxide, which can be DEADLY. This dangerous gas, if breathed in sufficient concentrations, can cause unconsciousness or even death. This exhaust system must be installed properly, in strict compliance with applicable codes and standards. Following installation, you must do nothing that might render the system unsafe or in noncompliance with such codes and standards. The generator compartment must be completely vapor sealed from the vehicle interior. There must be no possibility of exhaust fumes entering the vehicle interior. Never operate this equipment with a leaking or defective exhaust system.
- Keep hands, feet, clothing, etc., away from drive belts, fans, and other moving or hot parts. Never remove any drive belt or fan guard while the unit is operating.
- Adequate, unobstructed flow of cooling and ventilating air is critical to correct generator operation and is required to expel toxic fumes and fuel vapors from the generator compartment. Without sufficient cooling airflow, the engine/generator quickly overheats, which causes serious damage to the generator. Do not alter the installation or permit even partial blockage of ventilation provisions, as this can seriously affect safe operation of the generator.
- When working on this equipment, remain alert at all times. Never work on the equipment when you are physically or mentally fatigued.
- Inspect the generator regularly, and contact your nearest Generac Authorized Service Dealer immediately for parts needing repair or replacement.
- Before performing any maintenance on the generator, disconnect its battery cables to prevent accidental start up. Disconnect the cable from the battery post indicated by a NEGATIVE, NEG or (–) first. Reconnect that cable last.
- Never use the generator or any of its parts as a step. Stepping on the unit can stress and break parts, and may result in dangerous operating conditions from leaking exhaust gases, fuel leakage, oil leakage, etc.





**GENERAL  
INFORMATION**

**Section 1 – General Information**  
**PRIMEPACT 55G and 55LF Recreational Vehicle Generators**

Please record the following information from the generator nameplate:

- |                 |                  |
|-----------------|------------------|
| 1. Model Number | 2. Serial Number |
| 3. kW Rating    | 4. Rated Voltage |
| 5. Phase        | 6. Hertz         |



## 1.2 GENERATOR APPLICABILITY

These generators have been designed and manufactured for supplying electrical power for recreational vehicles. You should not modify the generator or use it for any application other than for what it was designed. If there are any questions pertaining to its application, write or call the factory. Do not use the unit until you have been advised by competent authority.



- ⚠ For fire safety, the generator must have been properly installed in compliance with ANSI 119.2-1975/NFPA 501C-1974, "Standard for Recreational Vehicles, Part III – Installation of Electrical Systems." The generator also must have been installed in strict compliance with the manufacturer's detailed installation instructions. After installation, do nothing that might render the unit in noncompliance with such codes, standards and instructions.**

You can use your generator set to supply electrical power for operating one of the following electrical loads:

- PRIMEPACT 55G: 120 and/or 240 volts, single phase, 60 Hz electrical loads. These loads can require up to 5500 watts (5.5 kW) of power, but cannot exceed 45.8 AC amperes of current at 120 volts or exceed 22.9 AC amperes at 240 volts.
- PRIMEPACT 55LP: 120 and/or 240 volts, single phase, 60 Hz electrical loads. These loads can require up to 5200 watts (5.2 kW) of power, but cannot exceed 43.3 AC amperes of current at 120 volts or exceed 21.6 AC amperes at 240 volts.



- ⚠ Do not overload the generator. Some installations may require that electrical loads be alternated to avoid overloading. Applying excessively high electrical loads may damage the generator and may shorten its life. Add up the rated watts of all electrical lighting, appliance, tool and motor loads the generator will power at one time. This total should not be greater than the wattage capacity of the generator. If an electrical device nameplate gives only volts and amps, multiply volts times amps to obtain watts (volts x amps = watts). Some electric motors require more watts of power (or amps of current) for starting than for continuous operation.**

## 1.3 INSTALLATION

This Owner's Manual has been prepared under the assumption that a competent, qualified technician installed the generator into an industrial vehicle. We also assume the installer complied with all applicable codes, standards and regulations pertaining to installation.

An INSTALLATION MANUAL was shipped with the generator. That Manual contains manufacturer's instructions and recommendations for installing the unit into an industrial vehicle. After installation, installers should forward the Installation Manual to Owners/Operators for their information.

Owners/Operators have the responsibility to make sure that nothing is done that might render the installation unsafe or in non-compliance with applicable codes, standards and instructions.

## 1.4 SAFETY

Before using the generator set, carefully read GENERAL SAFETY RULES inside the cover. Comply with these RULES to prevent accidents and damage to equipment and/or property. Generac suggests copying and posting the GENERAL SAFETY RULES to potential operators of this equipment.

## 1.5 GENERATOR AC CONNECTION SYSTEM

These air-cooled generator sets are equipped with dual stator AC power windings. These two stator windings supply electrical power to customer electrical loads by means of a dual 2-wire connection system.

The generator may have been installed so that units only power 120 volts AC loads (Figure 1); or you can wire them to connect both 120 and/or 240 volts AC electrical loads. Be sure to remove the jumper between the circuit breakers when connecting for 120/240 volts.

*Figure 1.1 – Connection for 120 Volts Only*

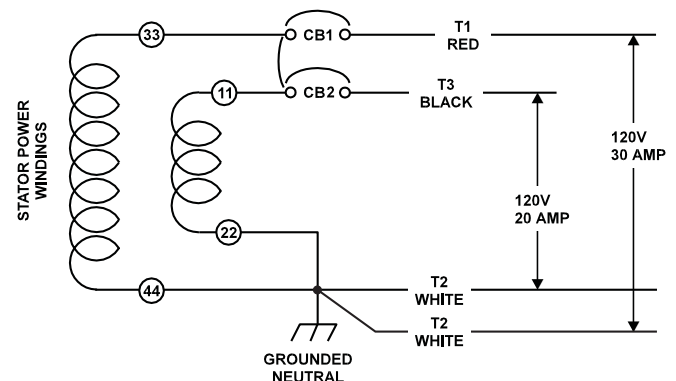

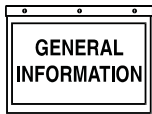

## Section 1 – General Information

### PRIMEPACT 55G and 55LP Recreational Vehicle Generators

## 1.6 SPECIFICATIONS

### ◆ 1.6.1 FUEL REQUIREMENTS

This generator is equipped with a gasoline fuel system as standard equipment. Specific installations may provide either a separate fuel tank for the generator, or the generator may “share” the vehicle engine’s fuel tank.

Model	No Load	1/2 Load	Full Load
PrimePact 55G	0.29	0.54	0.96
PrimePact 55LP	0.47/2.01	0.85/3.62	1.66/7.05

#### NOTE

**Some installations using a “shared” fuel tank may have a generator fuel pickup tube that is shorter than the vehicle engine’s pickup tube. Such an arrangement causes the generator engine to “run out of gas” while adequate fuel for the vehicle remains in the tank.**

To reduce lead and carbon deposits use high quality UNLEADED gasoline with the generator. Leaded REGULAR grade gasoline is an acceptable substitute.

#### NOTE:

**Using unleaded gasoline contributes to longer engine valve life by reducing lead and carbon deposits.**



**⚠ Generac does not recommend using any gasoline containing alcohol (such as “gasohol”). If you use any gasoline containing alcohol, it must not contain more than 10 percent ethanol, and it must be removed from the generator during storage. Do NOT use any gasoline containing methanol. If you use gasoline with alcohol, inspect more frequently for fuel leaks and other abnormalities.**

### ◆ 1.6.2 ENGINE OIL REQUIREMENTS

Use only high quality detergent oil classified “For Service SF” and with an oil viscosity rating of SAE

10W-30 oil. Do not pour in any additives to the recommended oil. Engine crankcase capacity is 1.4 liters. See Section 3.2 on page 11 for oil level check and filing procedures.

### ◆ 1.6.3 ENGINE SPECIFICATIONS

Type of Engine	PRIMEPACT 55G/55LP .....	GN-480
Cooling Method .....	Air-cooled	
Rated Horsepower	PRIMEPACT 55G/55LP .....	15 at 3600
Displacement	PRIMEPACT 55G/55LP .....	480cc
Compression Ratio.....	8.6 to 1	
Cylinder Block .....	Aluminum w/Cast Iron Sleeve	
Type of Governor .....	Mechanical, Fixed Speed	
Engine Governor Speed .....	2500 rpm	
Air Cleaner .....	Paper Element w/Foam Precleaner	
Starter .....	12-volt DC Electric	
Ignition System .....	Solid-state w/Flywheel Magneto	
Recommended Spark Plug	Champion .....	RC12YC
	AC.....	R45S
	Fram Autolite .....	65
Spark Plug Gap.....	0.030 inch (0.8 mm)	
Recommended Min. Battery .....	400 Cold Cranking Amps	

### ◆ 1.6.4 EMISSIONS COMPLIANCE PERIOD

For nonhandled engines the Emissions Compliance Period referred to on the Emissions Compliance Label indicates the number of operating hours for which the engine has been shown to meet Federal emission requirements.

- For engines less than 225 cc displacement, Category C=125 hours, B=250 hours, and A=500 hours.

### ◆ 1.6.5 GENERATOR SPECIFICATIONS

SERIES	PRIMEPACT 55G	PRIMEPACT 55LP
Rotor RPM	3600	3600
Rotor Poles	2	2
Engine RPM	2500	2500
Rated Max. Continuous AC Output*	5500 watts (5.5 kW)	5200 watts (5.2 kW)
Voltage*	120	120
Rated Max. Continuous Current*	45.8 AC amps‡	43.3 AC amps ¶
Phase	1	1
Frequency	60 Hertz	60 Hertz
Battery Charging Current (Max.)	2 amps (trickle charge)	2 amps (trickle charge)
Weight	211 pounds	214 pounds
Length	25 inches	25.75 inches
Width	18.5 inches	18.5 inches
Height	16.13 inches	16.13 inches

\* All units are reconnectable to 120 and/or 240 volts, dual voltage output. Units are not listed per RVIA/ANSI when reconnected for dual voltage output

‡ Rated maximum continuous current at 240 volts is 22.9 amps.

¶ Rated maximum continuous current at 240 volts is 21.6 amps.

**6 Generac® Power Systems, Inc.**



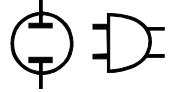

- For engines of 225 cc or more, Category C=250 hours, B=500 hours, and A=1000 hours.

## 2.1 GENERATOR CONTROL PANEL

The following features are mounted on the generator control panel (Figure 2.1):

### ◆ 2.1.1 FUEL PRIMER

Before starting a cold engine (if it has not been started in more than two weeks), you must press this switch for approximately 10 seconds to bring fuel from the tank to the fuel pump. This rocker type switch springs back into its original position when you release it.

### ◆ 2.1.2 START/STOP SWITCH

To crank and start the engine, hold this switch in the START position. Release the switch when the engine starts. To stop an operating engine, press and hold the switch in the STOP position until the engine shuts off. The switch center position is the RUN position.

### ◆ 2.1.3 15 AMP FUSE

The fuse protects the engine's DC control circuit against electrical overload. If the fuse element has melted open due to overloading, the engine cannot be cranked. If you must replace the fuse, use only an identical 15 amp replacement fuse.

### ◆ 2.1.4 LINE BREAKERS

Protects generator's AC output circuit against overload, i.e., prevents unit from exceeding wattage/ampere capacity. This unit has one 20-amp and one 30-amp breaker.

Figure 2.1 – Typical Control Panel

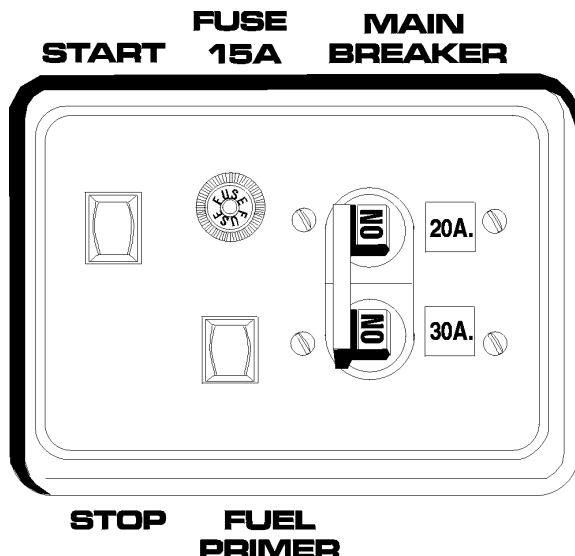

### NOTE:

If this generator has been reconnected for dual voltage AC output (120/240 volts), you can install line breakers having an amperage rating that is different than that stated above. The replacement line breakers consist of two separate breakers with a connecting piece between the breaker handles (so that both breakers will operate at the same time). If the unit is reconnected for dual voltage, it is no longer RVIA listed.

## 2.2 OPTIONAL REMOTE START/STOP PANEL

A remote mounted Start/Stop Panel (Figure 2.2) is available that allows you to start and stop the generator engine conveniently from inside the vehicle. The remote panel includes a Start/Stop switch, hourmeter, generator run lamp and a wire harness.

Figure 2.2 — Optional Remote Panel (Models 004057 and 004184)

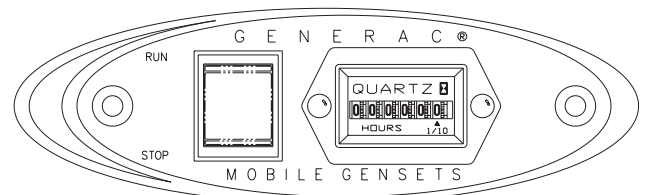

## 2.3 AUTOMATIC CHOKE

This engine is equipped with an automatic choke that consists of two main components: a choke solenoid and prechoke.

### ◆ 2.3.1 CHOKE SOLENOID

During engine cranking (Start/Stop switch at START), a solid-state choke module signals the choke solenoid to activate and cycle (choke on/choke off) until the engine starts. The choke solenoid thus opens and closes the carburetor choke valve only when the engine is cranking. When the engine starts, the choke stops cycling.

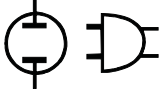

### ◆ 2.3.2 PRECHOKE

The choke system also has a temperature-sensitive metal strip that adjusts choke valve angle according to ambient temperatures (i.e., in cold ambient temperatures, choke valve closes more). Once the engine starts, an element heats the temperature-sensitive strip to a normal operating condition, opening the choke valve. This may take about three minutes in cooler weather.

## 2.4 BEFORE STARTING THE ENGINE

### NOTE:

**Instructions and information in this manual assume the generator has been properly installed, connected, serviced, tested and adjusted by a qualified installation technician or installation contractor.**

### ◆ 2.4.1 INSTALLATION

Generator installation must have been properly completed so it complies with all applicable codes, standards and regulations and with the manufacturer's recommendations.

### ◆ 2.4.2 ENGINE LUBRICATION

Have the engine crankcase properly serviced with the recommended oil before starting. Refer to Section 1.6.3 (Page 6) and Sections 3.1 and 3.2 (Page 11) for oil servicing procedures and recommendations.



Any attempt to crank or start the engine before you have properly serviced it with the recommended oil may result in an engine failure.

### ◆ 2.4.3 FUEL SUPPLY

The engine must have an adequate supply of proper fuel to operate. Before starting it, check that sufficient fuel is available.

### NOTE:

**Depending on the installation, the generator may have either a separate fuel tank, or it may “share” the vehicle engine’s fuel tank.**

### ◆ 2.4.4 COOLING AND VENTILATING AIR

Air inlet and outlet openings in the generator compartment must be open and unobstructed for continued proper operation. Without sufficient cooling and ventilating airflow, the engine/generator quickly overheats, which causes it to shut down and may damage the generator.

### ◆ 2.4.5 ENGINE EXHAUST GAS

Before starting the generator engine, you should be sure there is no way for exhaust gases to enter the vehicle interior and endanger people or animals. Close windows, doors and other openings in the vehicle that, if open, might permit exhaust gases to enter the vehicle.



The generator engine gives off **DEADLY** carbon monoxide gas through its exhaust system. This dangerous gas, if breathed in sufficient concentrations, can cause unconsciousness or even death. Never operate the generator set with the vehicle inside any garage or other enclosed area. **DO NOT OPERATE THE GENERATOR IF THE EXHAUST SYSTEM IS LEAKING OR HAS BEEN DAMAGED. SYMPTOMS OF CARBON MONOXIDE POISONING ARE (a) inability to think coherently; (b) vomiting; (c) twitching muscles; (d) throbbing temples; (e) dizziness; (f) headaches; (g) weakness; and (h) sleepiness. IF YOU FEEL ANY OF THESE SYMPTOMS, MOVE INTO FRESH AIR IMMEDIATELY. IF SYMPTOMS PERSIST, GET MEDICAL HELP.**

## 2.5 STARTING THE GENERATOR

### NOTE:

**Read the vehicle manufacturer’s instructions. The owner/operator should become familiar with the vehicle in which this generator is installed. Differences exist between vehicles. For example, some vehicles may use a transfer switch to isolate dockside power from the generator, while other vehicles may use an isolating receptacle. Some vehicles may be equipped with a DC converter which allows the generator to power certain DC lighting and other DC loads.**

To crank and start the generator engine, proceed as follows:

1. Turn OFF electrical loads using the means provided in your vehicle (such as a main line circuit breaker or transfer switch).

### NOTE:

**If starting from the generator control panel, turn OFF loads by setting the generator’s main circuit breaker to the OFF (or open) position. If starting from a remote panel, turn OFF loads using the means provided in the vehicle (such as a main circuit breaker). Electrical load circuits will be turned ON after the generator has started, stabilized and warmed up.**

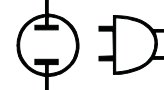

2. If you have not started the engine in more than two weeks, press the Fuel Pump Primer switch and hold it for about 10 seconds. However, if the engine is warm, skip Step 2.
3. To crank and start the engine, hold the start/stop switch at START. Release the switch when the engine starts.



**▲ If the engine does not start after it has been cranking for 15 seconds, release the Start/Stop switch and wait 1 minute before trying again. Holding the switch for longer than 15 seconds can damage the starter motor.**

4. Let the engine run at no-load for a few minutes to stabilize and warm up.
5. Turn ON electrical loads using the means provided (such as a main circuit breaker or transfer switch).

## 2.6 STOPPING THE GENERATOR

1. Turn OFF all electrical loads using the means provided (such as a main circuit breaker or transfer switch).
2. Let generator run at no-load for a few minutes, to stabilize internal engine generator temperatures.
3. Place the Start/Stop switch in its STOP position. The engine will come to a complete stop.

## 2.7 APPLYING LOADS TO GENERATOR

When applying electrical loads to the generator, observe these guidelines:

- Before applying electrical loads, let the generator stabilize and warm up for a minute or two.
- DO NOT overload the generator.

### ◆ 2.7.1 LETTING THE ENGINE STABILIZE

The generator supplies correct rated voltage only at the proper governed speed. Some electrical appliances may be extremely sensitive to voltage. Incorrect voltages can damage such appliances.

If electrical loads are applied at reduced operating speeds, such loads imposed on the engine when sufficient power is not available may shorten engine life. Never turn ON electrical loads until after the generator engine has started and stabilized at no-load.

### ◆ 2.7.2 DO NOT OVERLOAD THE GENERATOR

You can read the rated wattage/amperage capacity of your generator on the generator data decal (see Section 1.1 on Page 4).

Applying electrical loads in excess of the unit's rated capacity will cause the engine/generator to automatically shut down.

To avoid overloading, add up the wattage of all connected electrical lighting, appliance, tool and motor loads. This total should not be greater than the generator's rated wattage capacity.

- Most lighting, appliance, tool and motor loads indicate their required watts on their nameplate or data plate. For light bulbs, simply note the wattage rating of the bulb.
- If a load does not show its rated wattage, multiply that load's rated VOLTS times AMPS to obtain WATTS.
- Induction type motors (such as those that run the vehicle's furnace fan, refrigerator, air conditioner, etc.) need about 2-1/2 times more watts of power for starting than for running (for a few seconds during motor starting). Be sure to allow for this when connecting electrical loads to the generator. First, figure the watts needed to start electric motors in the system. To that figure, add the running wattages of other items that will be operated by the generator.
- Do not apply heavy electrical loads for the first two or three hours of operation.

## 2.8 PROTECTION SYSTEMS

### ◆ 2.8.1 LOW OIL PRESSURE SWITCH

This switch (Figure 2.3 on page 10) has normally open (N.O.) contacts that are held open by engine oil pressure during cranking and operating. Should oil pressure drop below a preset level, switch contacts close, and the engine automatically shuts down. The unit should not be restarted until oil is added.

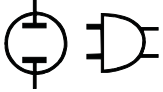

**2.8.2 HIGH TEMPERATURE SWITCH**

This switch (Figure 2.3), which has normally open (N.O.) contacts, is mounted near the oil filter. The contacts close if the temperature should exceed approximately 284° F (140° C), initiating an engine shutdown.

*Figure 2.3 – Low Oil Pressure and High Temperature Switches*

**2.8.3 FIELD BOOST**

The Controller Circuit Board houses a field boost diode and resistor that are not part of the automatic choke circuit. These two components are part of a “field boost” circuit (Figure 2.4). During engine cranking only, a positive DC (battery) voltage is delivered through the diode, resistor, brushes and slip rings, and the generator rotor. Application of this voltage to the rotor “flashes the field” whenever it is started. Flashing of the field each time the generator starts makes sure that a sufficiently strong magnetic field is available to produce “pickup” voltage in the stator windings.

*Figure 2.4 – Field Boost Circuit*

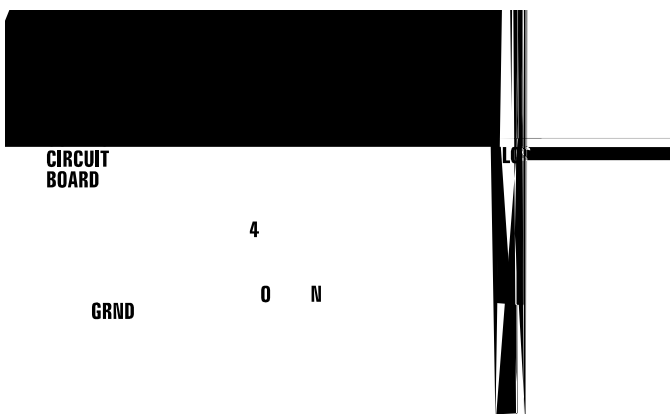

**2.8.4 OVERVOLTAGE PROTECTION**

A solid-state voltage regulator (Figure 2.5) controls the generator’s AC output voltage. This regulator supplies an excitation current to the rotor. By regulating the rotor’s excitation current, the strength of its magnetic field is regulated and, in turn, the voltage delivered to connected electrical loads is controlled. When the AC frequency is 50 Hertz, voltage is regulated at 115 volts.

*Figure 2.5 – Solid State Voltage Regulator*

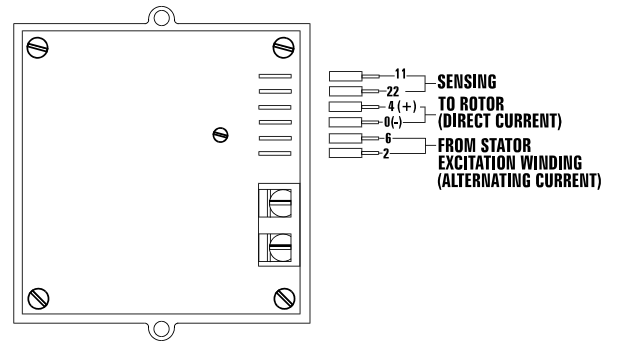

The voltage regulator also incorporates a “voltage surge protection circuit.” This circuit prevents troublesome surges in the generator AC output voltage. Voltage surge is a common cause of damage to electronic equipment.

**2.8.5 25-HOUR BREAK-IN PERIOD**

The first 25 hours of operation is the break-in period for the generator. Properly breaking in the generator is essential to minimize fuel consumption and provide maximum engine performance. During this 25-hour break-in period, follow this procedure:

- Run the unit at varying electrical loads to help seat the engine piston rings properly.
- Check the engine oil level frequently. Add oil if needed. It is normal for the generator engine to consume more oil than is normal until the piston rings have properly seated.
- For the 75-hour operation following the break-in period, avoid light electrical loads. Load the generator at 50 percent (or more) of its rated wattage capacity. Repeated light loads during these 75 hours can cause improper seating of engine piston rings, resulting in blowby and high oil consumption.
- After operating the unit for 25 hours, complete the tasks recommended under Section 2.8.6.



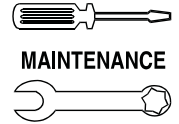

MAINTENANCE

### ◆ 2.8.6 25-HOUR CHECK-UP

After the 25-hour break-in period, contact a Generac Authorized Service Dealer for the following maintenance. The vehicle owner is responsible for any charges:

- Change the engine crankcase oil and oil filter.
- Check all fluid levels.
- Inspect the cooling and ventilation openings.
- Check the engine ignition system.
- Inspect the entire electrical system.
- Inspect the engine exhaust system.

### ◆ 2.8.7 OPERATION IN HIGH GRASS OR BRUSH

**WARNING**

Never operate the generator while the vehicle is parked over high grass, weeds, brush, leaves or any other combustible substance. Such materials can ignite and burn from the heat of the exhaust system. The generator exhaust system becomes extremely hot during operation and remains hot for a long time after it has shut down.

## 3.1 CHECKING THE ENGINE OIL LEVEL

For oil capacities and requirements, see “Engine Oil Requirements,” Section 1.6.2 (Page 6). Check the engine crankcase oil level at least every eight hours of operation, or before you use it. To check the engine oil level, proceed as follows (see Figure 3.1):

1. Be sure the generator is as level as possible.
2. Remove the dipstick and wipe it dry with a clean, lint-free cloth.
3. Install and tighten the dipstick cap; then, remove it again. The oil level should be at the dipstick “Full” mark.
4. If necessary, remove the oil fill cap on the rocker cover and slowly add oil until it reaches the dipstick “Full” mark. **DO NOT FILL ABOVE THE “FULL” MARK.**

**CAUTION**

Never operate the engine with the oil level below the “Add” mark on the dipstick. Doing this could damage the engine.

5. Install and tighten the oil fill cap and the dipstick before operating the engine.

## 3.2 CHANGING THE ENGINE OIL AND/OR OIL FILTER

- Change the **engine oil** after the first 25 hours of operation (after the 25-hour break-in period, see Section 2.8.5, Page 10). Thereafter, change the oil every 100 operating hours. Change the oil more frequently if operating consistently under heavy load or at high ambient temperatures.
- Change the **engine oil filter** after the first 25 hours of operation, and every 100 operating hours thereafter.

To change the oil and/or oil filter, proceed as follows:

1. Run the engine until it is thoroughly warmed up (at least five minutes) then shut OFF the engine.
2. With the engine still warm from running, remove the oil drain plug (Figure 3.1). Drain the oil into a suitable container.
3. After the oil has drained, replace the oil drain plug. (If only changing the oil, go to step 7.)
4. With the oil drained, remove the old oil filter by turning it counterclockwise (Figure 3.2 on page 12).
5. Apply a light coating of clean engine oil to the gasket of the new filter.
6. Screw the new filter on by hand until its gasket lightly contacts the oil filter adapter. Then, tighten the filter an additional 3/4 to one turn.
7. Remove the dipstick and fill crankcase with the proper type and amount of recommended oil (see Section 1.6.2, Page 6). The engine crankcase can hold about 1.4 liters. **DO NOT FILL ABOVE THE “FULL” MARK.**
8. Install and tighten the dipstick before operating the engine.
9. Start the engine and check for leaks.

**NOTE:**

**Check the oil level and fill to the “FULL” mark after checking for leaks. The filter will retain some oil.**

**Figure 3.1 — Oil Dipstick/Fill Tube and Location of Oil Drain Plug**

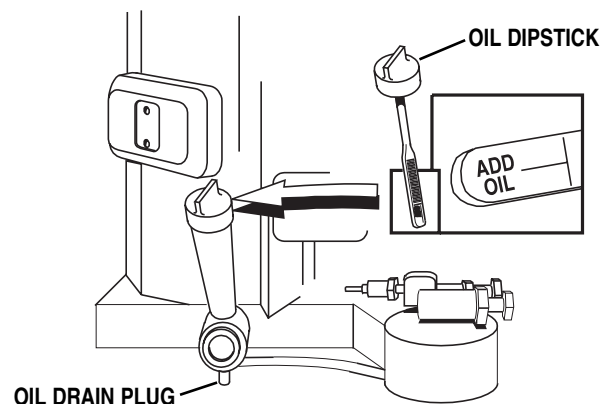

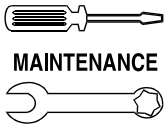

## Section 3 – Maintenance

### PRIMEPACT 55G and 55LP Recreational Vehicle Generators

Figure 3.2 — Engine Oil Filter

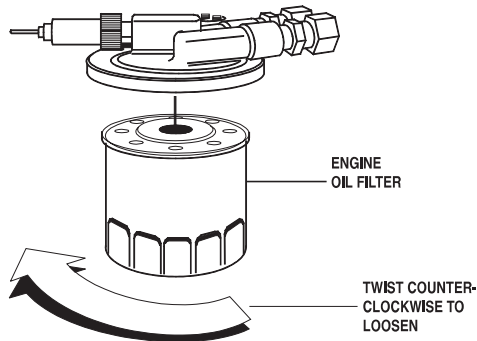

## 3.3 MAINTAINING THE ENGINE AIR CLEANER

### ◆ 3.3.1 CLEANING THE FOAM PRECLEANER

Clean and re-oil the foam precleaner every three months or every 25 hours of operation, whichever occurs first. Service the foam precleaner more frequently if operating the generator in extremely dusty or dirty conditions. Use the following procedure (Figure 3.3):

1. Turn the knob counterclockwise to loosen.
2. Remove the cover, foam precleaner and paper filter.
3. Remove the foam precleaner from the cover.
4. Wash the foam precleaner in liquid detergent and water.
5. Wrap the foam precleaner in a clean cloth and gently squeeze it dry.
6. Saturate the foam precleaner in clean engine oil. Gently squeeze it in a clean cloth to remove excess oil and to distribute oil (DO NOT TWIST).
7. Install the foam precleaner into the cover, followed by the paper filter. Tabs at edges of paper filter must lock into slots on cover.
8. Install the cover, foam precleaner and paper filter.
9. Replace knob to retain the filter in place.

Figure 3.3 – Engine Air Cleaner

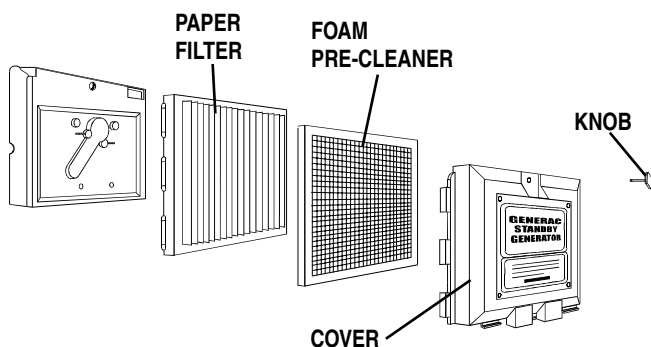

## 3.4 CLEAN AIR INTAKE SCREEN

Clean all foreign material from the air intake screen (Figure 3.4) at least once every 100 hours of operation. Clean more often if necessary.

Inspect the area around the generator exhaust muffler periodically and remove all grass, leaves, dirt, etc., from this area.

Figure 3.4 – Cleaning Air Intake

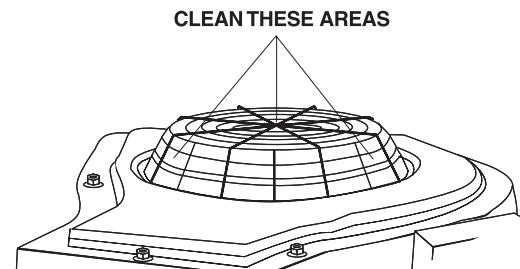

## 3.5 CHECKING THE ENGINE SPARK PLUG

Clean the spark plug and reset the spark plug gap every 100 hours of operation.

1. Clean the area around the base of the spark plug to keep dirt and debris out of the engine. Clean by scraping or washing using a wire brush and commercial solvent. Do not blast the spark plug to clean.
2. Remove the spark plug and check the condition. Replace the spark plug if worn or if reuse is questionable.
3. Check the spark plug gap using a wire feeler gauge. Adjust the gap to 0.030 inch (0.76 mm) by carefully bending the ground electrode (Figure 3.5).

Figure 3.5 – Setting the Spark Plug Gap

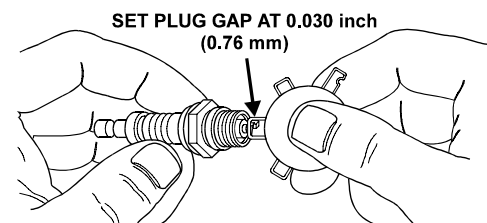

- ⚠ CAUTION ⚠
- ⚠ Sparking can occur if the wire terminal does not fit firmly on the spark plug terminal end. If necessary, re-form the wire terminal to obtain a tight fit.

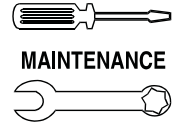

MAINTENANCE

### 3.6 FUEL FILTER (GASOLINE ONLY)

Remove and replace the fuel filter (Figure 3.6) once each year or every 100 hours of operation, whichever comes first.

Figure 3.6 – Fuel Filter

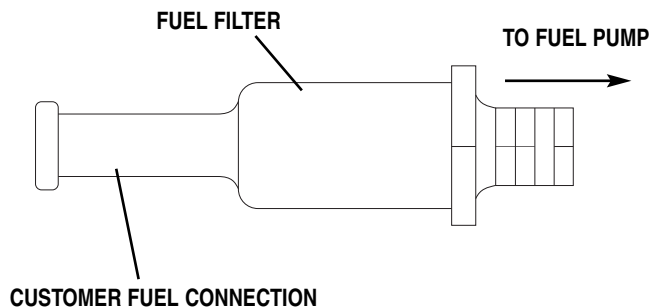

### 3.7 SPARK ARRESTOR MUFFLER

If the generator is not equipped with a spark arrestor exhaust muffler and is to be used on any forest covered, brush covered or grass covered unimproved land, you may have to install a spark arrestor. The spark arrestor must be maintained in effective working order by the vehicle owner/operator.

For assistance in ordering, installing and maintaining spark arrestor exhaust mufflers, contact your nearest Generac Authorized Service Dealer.

Exhaust mufflers supplied by Generac are spark arrestor types. Generac exhaust mufflers for recreational vehicle generators do not have a spark arrestor screen, but are of the more efficient “toroid” or “swirl” type. To remove carbon and combustion deposits from such mufflers, remove the plug from the muffler and run the engine for approximately 15 minutes. Shut down the engine, let the muffler cool and install the plug.

#### WARNING

- ⚠ Be sure to reinstall the muffler plug tightly. Engine vibration could cause a loose plug to fall out. Without the plug in place, hot engine exhaust is directed out the opening. This hot exhaust, depending on the installation, could be directed to areas not able to withstand the extreme heat such as wooden floor boards or other flammable material. This could result in a fire.

### 3.8 CLEANING THE GENERATOR

Keep the generator set as clean and dry as possible. Protect the unit against excessive dust, dirt, corrosive vapors, road splash, etc. Permitting dirt and moisture to accumulate on generator windings will have an adverse effect on the insulation resistance of those windings.

When moisture is allowed to remain in contact with windings, some of the moisture will be retained in voids and cracks in the insulation. This causes a reduced insulation resistance and will eventually cause problems. Dirt will make the problem worse, since dirt tends to hold moisture in contact with windings. Salt (as from sea air) also will worsen the problem since it tends to absorb moisture from the air. Salt and moisture, when combined, form a good electrical conductor.

#### CAUTION

- ⚠ Do NOT use a forceful spray of water to clean the generator. Water will enter the generator interior and cause problems, and may also contaminate the generator fuel system.

### 3.9 BATTERY MAINTENANCE

All lead-acid batteries will discharge when not in use. The generator battery should be inspected as follows:

#### ◆ 3.9.1 WEEKLY

- Inspect the battery posts and cables for tightness and corrosion. Tighten and clean as necessary.
- Check the battery fluid level of unsealed batteries and, if necessary, fill with Distilled Water Only. Do not use tap water in batteries.

#### ◆ 3.9.2 EVERY SIX MONTHS

- Have the state of charge and condition checked. This should be done with an automotive-type battery hydrometer.

#### NOTE:

**Servicing of the battery is to be performed or supervised by personnel knowledgeable of batteries and the required precautions. Keep unauthorized personnel away from batteries.**

**Damage will result if the battery connections are made in reverse.**

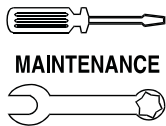

## Section 3 – Maintenance

### PRIMEPACT 55G and 55LP Recreational Vehicle Generators

#### **⚠ DANGER ⚠**

**⚠ Do not dispose of the battery in a fire. The battery is capable of exploding. Storage batteries give off explosive hydrogen gas. This gas can form an explosive mixture around the battery for several hours after charging. The slightest spark can ignite the gas and cause an explosion. Such an explosion can shatter the battery and cause blindness or other injury. Any area that houses a storage battery must be properly ventilated. Do not allow smoking, open flame, sparks, or any spark producing tools or equipment near the battery. Discharge static electricity from your body before touching the battery by first touching a grounded metal surface.**

**⚠ A battery presents a risk of electrical shock and high short circuit current. The following precautions are to be observed when working on batteries:**

- Remove watches, rings or other metal objects;
- Use tools with insulated handles;
- Wear rubber gloves and boots;
- Do not lay tools or metal parts on top of the battery;
- Disconnect any charging source prior to connecting or disconnecting battery terminals; and
- Do not use any jumper cables or booster battery to crank and start the generator engine. If any battery has discharged, remove it for recharging.

#### **⚠ WARNING ⚠**

**⚠ Do not open or mutilate the battery. Released electrolyte has been known to be harmful to the skin and eyes, and to be toxic.**

**⚠ The electrolyte is a dilute sulfuric acid that is harmful to the skin and eyes. It is electrically conductive and corrosive. The following procedures are to be observed:**

- Wear full eye protection and protective clothing;
- Where electrolyte contacts the skin, wash it off immediately with water;
- Where electrolyte contacts the eyes, flush thoroughly and immediately with water and seek medical attention; and
- Spilled electrolyte is to be washed down with an acid neutralizing agent. A common practice is to use a solution of 1 pound (500 grams) bicarbonate of soda to 1 gallon (4 liters) or water. The bicarbonate of soda solution is to be added until the evidence of reaction (foaming) has ceased. The resulting liquid is to be flushed with water and the area dried.

## 3.10 MAJOR SERVICE MANUAL

To obtain a service manual for your generator, contact Generac or your nearest Generac Authorized Service Dealer. Make sure to identify your MODEL NUMBER and SERIES.

## 3.11 DRIVE BELT

The engine drives the generator rotor by means of a pulley and drive belt arrangement. The drive belt and pulleys are warranted for the life of the generator. Drive belt tension was properly adjusted before the unit was shipped from the factory. If you suspect that drive belt tension is incorrect, contact a Generac Authorized Service Dealer.

## 3.12 EXERCISING THE GENERATOR

Generac recommends that you start and operate the generator at least once every seven days. Let the unit run for at least 30 minutes to “exercise” the engine.

## 3.13 OUT OF SERVICE PROCEDURE

### ◆ 3.13.1 REMOVAL FROM SERVICE

If you cannot exercise the generator every seven days, and it is to be out of service longer than 30 days, prepare the generator for storage as follows:

1. Start the engine and let it warm up.
2. Close the fuel shutoff valve in the fuel supply line and allow the unit to shut down.
3. While the engine is still warm from running, drain the oil completely. Refill the crankcase with SAE 10W-30 oil having API classification “For Service SF.”
4. Attach a tag to the engine indicating the viscosity and classification of the oil in the crankcase.
5. Remove the spark plug and pour two or three tablespoons of clean, fresh engine oil into the spark plug threaded openings. Reinstall and tighten the spark plug.
6. Remove the battery and store it in a cool, dry room on a wooden board. Never store the battery on any concrete or earthen floor.
7. Clean and wipe the entire generator.



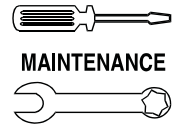

**◆ 3.13.2 RETURN TO SERVICE**

To return the unit to service after storage, proceed as follows:

1. Check the tag on the engine for oil viscosity and classification. Verify that the correct recommended oil is used in the engine (see Section 1.5.4, Page 6). If necessary, drain and refill with the proper oil.
2. Check the state of the battery. Fill all cells of unsealed batteries to the proper level with distilled water. **DO NOT USE TAP WATER IN THE BATTERY.** Recharge the battery to 100 percent state of charge, or, if defective, replace the battery.
3. Clean and wipe the entire generator.
4. Reconnect the battery. Observe battery polarity. Damage may occur if the battery is connected incorrectly.
5. Turn OFF all electrical loads. Add fuel if necessary and then start the engine.
6. Allow the unit to warm up thoroughly.
7. Apply electrical loads to at least 50 percent of the unit's rated wattage capacity.
8. When the engine is thoroughly warmed up, shut it down.
9. Your generator is now ready for service.

**3.14 WATTAGE REFERENCE GUIDE**

	Running Watts
Battery Charger .....	500
Belt Sander (3").....	1000
Chain Saw.....	1200
Circular Saw (6-12") .....	800 to 1000
Disc Sander (9") .....	1200
Hand Drill (1") .....	1100
Hedge Trimmer .....	450
Impact Wrench .....	500
Lawn Mower .....	1200
Electric Range (one element).....	1500
Television .....	1750 to 2000
Coffee Maker .....	1000
Electric Skillet.....	1250
Hair Dryer.....	1200
Light Bulb .....	100
Microwave Oven .....	700
Oil Burner on Furnace .....	300
Oil Fired Space Heater (140,000 Btu).....	400
Radio .....	50 to 200
Slow Cooker .....	200
*Furnace Fan (1/3 HP).....	1200
*Refrigerator .....	600
*Air Conditioner (12,000 Btu).....	1700
*Compressor (1HP).....	2000
*Deep Freeze .....	500
*Milk Cooler .....	1100
*Submersible Pump (1-1/2 HP).....	2800
*Submersible Pump (1 HP).....	2000
*Paint Sprayer, Airless (1/3 HP) .....	600
*Table Saw (10") .....	1750 to 2000

\* Allow 2-1/2 times the listed watts for starting these devices.



# **PART II – INSTALLATION INSTRUCTIONS**

—▲ **DANGER** ▲—

**ONLY QUALIFIED ELECTRICIANS OR CONTRACTORS  
SHOULD ATTEMPT INSTALLATION!!**



**⚠ DANGER:** For fire safety, installation of a generator into a recreational vehicle must comply strictly with article 551, NFPA 70; ANSI C1-1975; AND, ANSI A119.2-1975/NFPA 501C “Standard for Recreational Vehicles” (Part 3, “Installation of Electrical Systems”). In addition, installation must comply with the manufacturer’s instructions and recommendations.

## NOTICE TO INSTALLER

These *Installation Instructions* have been published by Generac to aid in the installation of the products described in this manual. Generac assumes that installation personnel are familiar with the procedures for installing such products, or similar products that Generac manufactures. Generac also assumes that personnel have been trained in the recommended installation procedures for these products and that such training includes (a) use of common hand tools, (b) use of special Generac tools, and (c) use of any tools and/or equipment from other suppliers.

Generac cannot possibly know of and advise the recreational vehicle trade of all conceivable methods, procedures or techniques by which to perform an installation. Nor can Generac anticipate every possible hazard that might result from each installation method, procedure or technique. Generac has not undertaken any such wide evaluation. Therefore, people who use a method, procedure or technique that Generac does not specifically recommend must first completely satisfy themselves that their safety, the safety of the vehicle's occupants and the product's safety is not endangered by the method, procedure or technique selected.

Information, illustrations, specifications, etc., contained in these *Installation Instructions* are based on the latest information available at the time of publication. Every effort has been expended to be sure that such data is both accurate and current. However, the manufacturer reserves the right to change, alter or otherwise improve this product at any time without prior notice.

## ⚠ DANGER ⚠

**⚠** Despite the safe design of this generator, operating this equipment imprudently, neglecting its maintenance or being careless can cause possible injury or death. Permit only responsible and capable persons to operate or maintain this equipment.

**⚠** Potentially lethal voltages are generated by these machines. Ensure all steps are taken to render the machine safe before attempting to work on the generator.

**⚠** Parts of the generator are rotating and/or hot during operation. Exercise care near running generators.

## ⚠ GENERAL HAZARDS ⚠

- For safety reasons, Generac recommends that the installation, initial start-up and maintenance of this equipment is carried out by a Generac Authorized Service Dealer.
- The engine exhaust fumes contain carbon monoxide, which can be DEADLY. This dangerous gas, if breathed in sufficient concentrations, can cause unconsciousness or even death. This exhaust system must be installed properly, in strict compliance with applicable codes and standards. Following installation, you must do nothing that might render the system unsafe or in noncompliance with such codes and standards. The generator compartment must be completely vapor sealed from the vehicle interior. There must be no possibility of exhaust fumes entering the vehicle interior. Never operate this equipment with a leaking or defective exhaust system.
- Keep hands, feet, clothing, etc., away from drive belts, fans, and other moving or hot parts. Never remove any drive belt or fan guard while the unit is operating.
- Adequate, unobstructed flow of cooling and ventilating air is critical to correct generator operation and is required to expel toxic fumes and fuel vapors from the generator compartment. Without sufficient cooling airflow, the engine/generator quickly overheats, which causes serious damage to the generator. Do not alter the installation or permit even partial blockage of ventilation provisions, as this can seriously affect safe operation of the generator.
- When working on this equipment, remain alert at all times. Never work on the equipment when you are physically or mentally fatigued.
- Before performing any maintenance on the generator, disconnect its battery cables to prevent accidental start up. Disconnect the cable from the battery post indicated by a NEGATIVE, NEG or (-) first. Reconnect that cable last.
- Never use the generator or any of its parts as a step. Stepping on the unit can stress and break parts, and may result in dangerous operating conditions from leaking exhaust gases, fuel leakage, oil leakage, etc.
- Never insert any tool or other object through openings in the generator interior, even if the unit is not running. You might seriously injure yourself or damage the equipment.





## **ELECTRICAL HAZARDS**

- The generator covered by this manual produces dangerous electrical voltages and can cause fatal electrical shock. Avoid contact with bare wires, terminals, connections, etc., while the unit is running. Ensure all appropriate covers, guards and barriers are in place before operating the generator. If you must work around an operating unit, stand on an insulated, dry surface to reduce shock hazard.
- Do not handle any kind of electrical device while standing in water, while barefoot, or while hands or feet are wet. **DANGEROUS ELECTRICAL SHOCK MAY RESULT.**
- During installation onto the vehicle, properly ground (bond) the generator either by solid mounting to the vehicle frame or chassis, or by means of an approved bonding conductor. **DO NOT** connect the bonding conductor to any generator part that might be removed or disassembled during routine maintenance. If the grounding conductor must be replaced, use only a flexible conductor that is of No. 8 American Wire Gauge (AWG) copper wire minimum.
- If the vehicle electrical circuits can be powered by any other source of electricity (such as a “dockside” power receptacle), there must be no possibility of connecting the different power sources to the vehicle circuits at the same time. The dockside (utility) power source must be positively isolated from the vehicle circuits whenever the generator is operating. Failure to isolate the vehicle circuits from the dockside power supply when the generator is running may result in damage to the generator or serious injury or death to dockside (utility) power workers due to backfeed of electrical energy.
- In case of accident caused by electric shock, immediately shut down the source of electrical power. If this is not possible, attempt to free the victim from the live conductor. **AVOID DIRECT CONTACT WITH THE VICTIM.** Use a nonconducting implement, such as a rope or board, to free the victim from the live conductor. If the victim is unconscious, apply first aid and get immediate medical help.
- Never wear jewelry when working on this equipment. Jewelry can conduct electricity resulting in electric shock, or may get caught in moving components causing injury.

## **FIRE HAZARDS**

- For fire safety, the generator must be installed and maintained properly. Installation always must comply with applicable codes, standards, laws and regulations. Adhere strictly to local, state and national electrical and building codes. Comply with regulations the Occupational Safety and Health Administration (OSHA) has established. Also, ensure that the generator is installed in accordance with the manufacturer’s instructions and recommendations. Following proper installation, do nothing that might alter a safe installation and render the unit in noncompliance with the aforementioned codes, standards, laws and regulations.
- Keep a fire extinguisher in the vehicle at all times. Extinguishers rated “ABC” by the National Fire Protection Association are appropriate for use on the recreational vehicle generator electrical system. Keep the extinguisher properly charged and be familiar with its use. If you have any question pertaining to fire extinguishers, consult your local fire department.

## **EXPLOSION HAZARDS**

- Do not smoke around the generator. Wipe up any fuel or oil spills immediately. Ensure that no combustible materials are left in the generator compartment, or on or near the generator, as **FIRE** or **EXPLOSION** may result. Keep the area surrounding the generator clean and free from debris.
- Gasoline is extremely **FLAMMABLE** and its vapors are **EXPLOSIVE**. Do not permit smoking, open flame, sparks or any source of heat in the vicinity while handling gasoline. Comply with all laws governing the storage and handling of gasoline.
- Fuel lines must be properly installed and fastened, and free of leaks. There must be no possibility of gasoline vapors entering the vehicle interior.
- You are required to install an approved, flexible, nonconductive fuel line between the generator fuel connection point and rigid fuel lines.
- If the generator is equipped with a liquid propane (LP) gas fuel system, install the unit so it complies with all codes, standards and regulations pertaining to such systems. LP gas is highly explosive. The gas tends to settle in low areas where even the slightest spark can ignite it and cause an explosion. Do not allow gas vapors to enter the vehicle.

## 5.1 PURPOSE AND SCOPE OF THE MANUAL

These *Installation Instructions* have been prepared especially for the purpose of familiarizing installers and owners of the applicable equipment with the product's installation requirements. Give serious consideration to all information and instructions in the manual, both for safety and for continued reliable operation of the equipment.

Because of the different recreational vehicle models and the variations between the models, it would be extremely difficult, if not impractical, to provide detailed instructions for every possible installation. For that reason, instructions and illustrations in this manual are general in nature. Illustrations are not intended to serve as detailed installation blueprints.

The installation should comply strictly with all applicable codes, standards and regulations pertaining to the installation and use of this product. If any portion of this manual appears to be in conflict with such codes, standards or regulations, the applicable codes, standards or regulations must take precedence over the manual.

## 5.2 SAFETY

Before handling, installing, operating or servicing this equipment, carefully read the "Notice to Installer" and "Safety Rules" on Pages 18 and 19. Comply with all safety rules to prevent death, personal injury or damage to equipment and/or property. Stress safety to all installers, operators and service technicians who work on this equipment.

## 5.3 STANDARDS BOOKLETS

Installation, use and servicing of this equipment should comply strictly with published standards, as well as the manufacturer's recommendations. The following standards booklets (latest revision) are available from the sources indicated:

1. NFPA Standard 501C, "Standard for Recreational Vehicles," available from the National Fire Protection Association, Batterymarch Park, Quincy, MA 02269.
2. NFPA 70, "NFPA Handbook of the National Electric Code," available same as Item 1.
3. ANSI C1-1975 and ANSI 119.2-1975, available from the American National Standards Institute, 1430 Broadway, New York, NY 10018.
4. ANSI A119.2/NFPA 501C, available from the Recreational Vehicle Association, 1896 Preston White Drive, Reston, VA 22090.
5. California Administrative Code, Title 25, available from the State of California, Documents Section, P.O. Box 1015, North Highlands, CA 95660.

6. CSA Electrical Bulletin 946, available from the Canadian Standards Association, Housing and Constructions Materials Section, 178 Rexdale Boulevard, Rexdale, Ontario, Canada, M9W 1R3.

## 5.4 EQUIPMENT DESCRIPTION

Instructions and information in this section pertain to Generac air-cooled generators. These generators are designed specifically for installing in recreational vehicles. They operate 120-volt, single-phase, 60-Hertz, AC electrical loads that require 40.0 amps (gasoline) or 37.5 amps (LP fuel) at 120 volts.

## 5.5 GENERATOR ENGINE OPERATING SPEED

The generator's revolving field (rotor) is driven by a single-cylinder, four-cycle engine through a pulley and drive belt arrangement. The generator supplies 120 volts AC at 60 Hertz when the rotor is operating at 3,600 rpm. The drive belt arrangement allows the engine to operate at a lower speed than the rotor.

## 5.6 GENERATOR AC CONNECTION SYSTEM

The generator is equipped with dual stator power windings as shown in Figure 1.1.

Figure 5.1 – 120-volt Single Voltage Connection

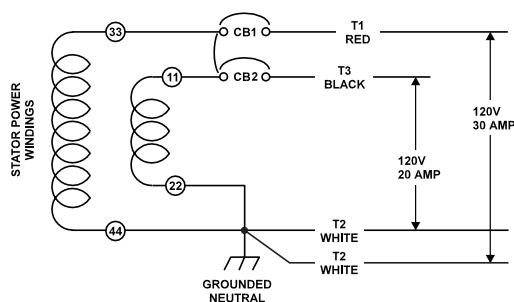

- The AC connection system on all air-cooled PRIMEPACT series generators uses a GROUND NEUTRAL.
- A separate green ground wire is connected to the recreational vehicle's junction box.
- For these PRIMEPACT units, loads connected across T1 (red) to T2 (white), MUST NOT exceed 30 amperes or 3,600 watts, and loads connected across T3 (black) and T2 (white) MUST NOT exceed 20 amperes or 2,400 watts each at 120 volts. The combined loading of the two breakers should not exceed 5,500 watts.

**NOTE:**

**Do NOT connect loads in excess of circuit breaker ratings.**

Figure 5.2 – Major Features and Dimensions

PrimePact 55G and 55LP

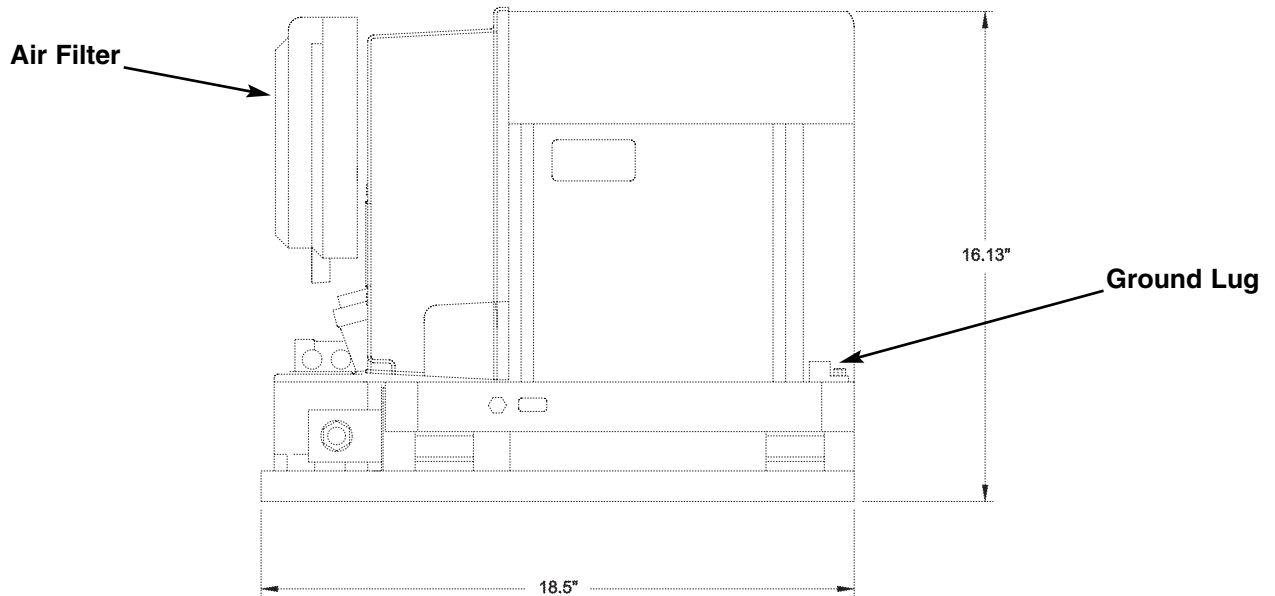
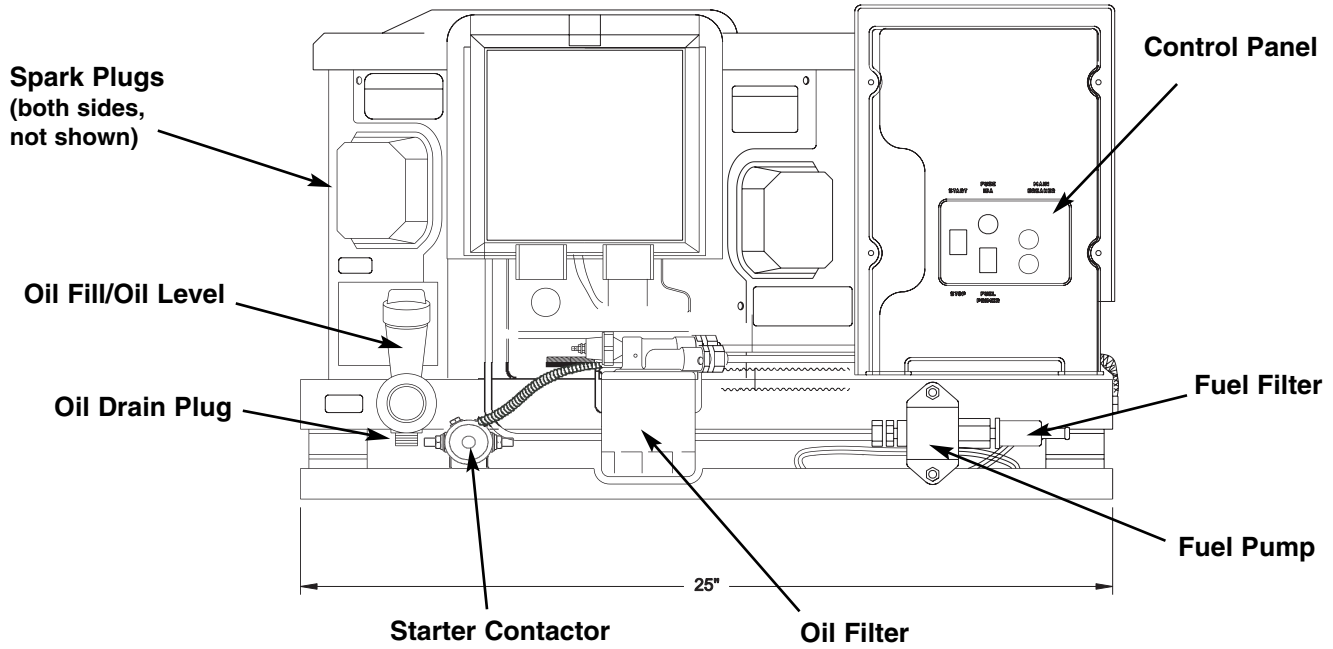

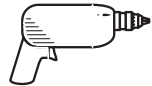

## 6.1 LOCATION AND SUPPORT

### ◆ 6.1.1 GENERATOR LOCATION

The most desirable location for the generator set is between the vehicle's main frame members. However, this is seldom possible. Most units must be installed on the side of the vehicle and are difficult to reinforce.

Many recreational vehicles have been factory equipped with an area for the generator set. Some vehicles may even have a generator compartment provided by the vehicle manufacturer.

Plan the generator location based on the following:

- The generator set must be installed on a framework that is part of the recreational vehicle, as outlined in Section 2.1.2.
- The location must provide an access opening that is large enough to permit generator removal (unless the generator is to be removed from underneath the supporting framework).
- The location must provide easy access to frequently serviced components, such as filters, oil drains, spark plugs and other common maintenance parts.
- The location must provide sufficient room to allow minimum clearances as outlined in Section 2.2. If sound insulation is to be used on the compartment walls and ceiling, the minimum recommended applies to the space between the generator and such insulation.
- The location must provide adequate cooling and ventilating airflow for the generator without a great deal of work and expense.

### ◆ 6.1.2 GENERATOR SUPPORT

The generator must be securely attached to a metal framework that has been made part of the vehicle frame structure by bolting or welding. The metal framework on which the generator will rest and which will restrain the generator set should consist of at least two horizontal beams. These beams should consist of (a) 1-1/2-inch square, 11-gauge steel tubing OR (b) 1-1/2-inch, 11-gauge angle iron. A typical supporting frame with horizontal support tubing, is shown in Figure 2.1.

The generator can be installed so that it sits on top of the horizontal support tubing if the vehicle design permits. Another method is to suspend the generator below the horizontal support tubing by means of suitable, structurally sound metal framework. The following general rules apply:

- Vehicle construction **MUST** be capable of supporting the weight of the generator.

- Whether the generator is mounted above the horizontal support tubing or suspended below the tubing, the supporting frame used must be structurally sound.
- If the generator cannot be bolted directly to the supporting frame or support tubing, consider using additional tubing, angle brackets or other supports to give the supporting frame sufficient strength.

Figure 6.1 – Typical Horizontal Support Frame

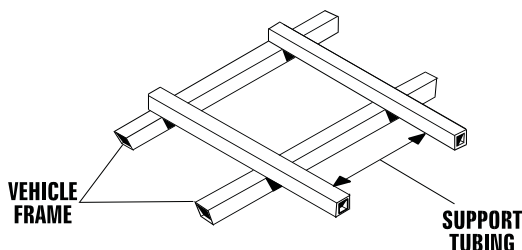

### ◆ 6.1.3 SUSPENDED MOUNTING

If you are going to suspend the generator below the horizontal support tubing, the suspension method you use with the vehicle frame members must (a) be able to support the weight of the generator AND (b) provide sufficient restraint for the generator. One typical suspended mounting system is shown in Figure 2.2. The location of a suspended mounting system must be carefully planned, keeping the following general rules in mind:

- Protect the generator against road splash and debris. Baffles or splash guards may be required to protect certain areas of the generator. To make sure the generator is adequately protected, road test the installation through mud, water and slush.

Figure 6.2 – Typical Suspended Mounting System

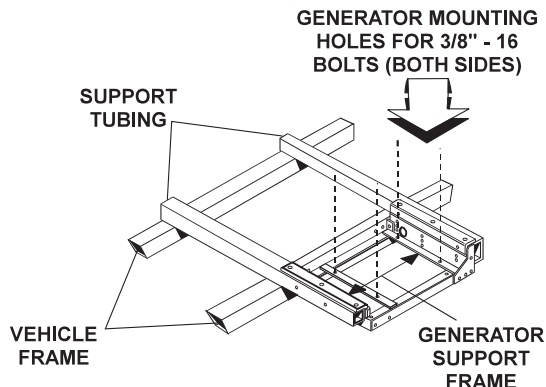

- The installer must make certain that the selected location will permit adequate cooling and ventilating airflow to be supplied.

Y61A E-04

Z11 124  
1AVV'00

VEHICLE  
HUSSE

ME A. L. FIED  
OTTO



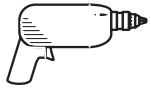

- If flexible metal conduit is used, it must be sealed internally at the end where it terminates inside the compartment's electrical junction box.

**NOTE:**

**Flexible metal conduit, due to its unique construction, is NOT vapor tight along its entire length.**

- Seams and joints of the galvanized steel (whether used as a liner or for the compartment itself) must be lapped and mechanically secured. Such seams may be manufactured, welded, bolted, riveted or screwed. Manufactured lock seams are shown in Figure 2.6. Installer constructed compartments typically utilize a standard lap joint.

Figure 6.6 – Types of Lock Seams

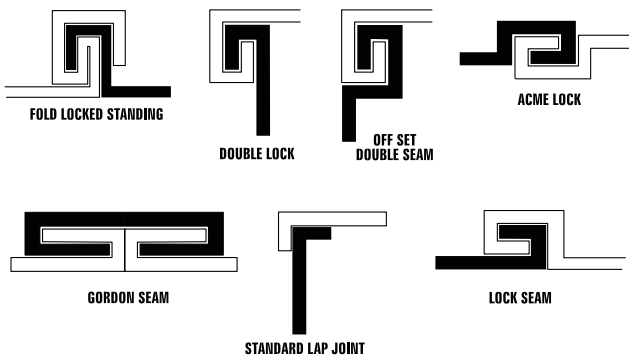

- After the compartment has been metal lined and vapor sealed, line the compartment interior walls and ceiling with an approved, nonflammable sound insulating material. See Section 2.2.3.

**! DANGER !**

**! Do not install any flammable material directly above or around the compartment. Heat, transferred through the compartment structure, may be sufficient to ignite, char or discolor seat cushions, fiberboard and other flammable materials. You may need to use approved nonflammable insulating materials in high temperature areas.**

**◆ 6.2.3 SOUND INSULATING MATERIALS**

Once installers have determined that a compartment is properly constructed and metal lined, they can add acoustical material. This may include additional sealant or insulating material, to reflect noise away from the vehicle interior.

Sound insulating materials should be of a nonflammable type. One excellent insulating material is a 1-inch (25 mm) thick fiberglass having a 2-pound density. When fiberglass is used, its coated side should face toward the compartment interior.

**! DANGER !**

**! Do not install sound insulation or any absorbent material on the compartment floor interior. Such materials will become soaked with combustible or explosive vapors and liquids and will become a fire hazard.**

Using a combination of sound insulating materials can often reduce noise more effectively than a single material. For example, a sheet of lead or visco-elastic material, along with a layer of other acoustical material, is more effective than when a single material is used.

**◆ 6.2.4 ACOUSTICS**

For additional noise abatement, the installer may wish to consider the following:

- Using special sound insulating materials.
- Construction of a special noise abatement compartment.

**NOTE:**

**Any method used to reduce noise must not adversely affect the flow of cooling and ventilating air into or out of the compartment.**

In addition to the effective use of sound insulating materials, construction of a special noise abatement compartment might be considered to reduce noise levels. Such a compartment might be constructed as follows (Figure 2.7):

- Use 5/8-inch thick or 3/4-inch thick plywood in the compartment.
- Construct the compartment floor of a double thickness of 5/8-inch or 3/4-inch plywood.
- Line the compartment interior walls and floor, as well as the underside of the floor, with 26-gauge galvanized steel.
- Vapor seal all compartment seams and joints.
- Over the galvanized steel lining, install a combination of acoustical materials as mentioned in Section 2.2.3.

**! DANGER !**

**! To prevent fire or explosion, do not install any insulation or other absorbent materials on the interior or underside of the compartment floor.**

- Seal all compartment door edges to prevent noise leakage around the door perimeter.
- Line the compartment door interior (except for air openings) with suitable, fireproof sound insulation (such as 1-inch (25 mm) thick fiberglass with a 2-pound density).

Figure 6.7 – Typical Noise Abatement

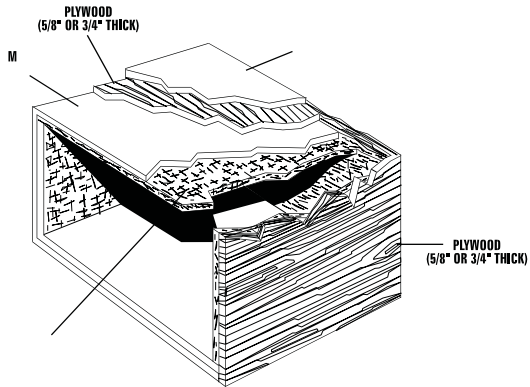

### ◆ 6.2.5 COMPARTMENT FLOOR CUTOUTS

You must provide openings in the generator compartment for the following items (Figure 2.8):

- Engine exhaust and cooling air outlets
- Generator cooling air inlet
- Four holes for passage of generator mounting bolts. See Section 2.1.4 (Page 23).

—  **DANGER**  —

 Fuel lines and exhaust piping must not penetrate into the vehicle living area.

**INSTALLATION**

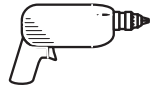

**Section 6 – Installation**  
**PRIMEPACT 55G and 55LP Recreational Vehicle Generators**

---

—  **DANGER**  —



Figure 6.12 – Air Inlet Using Ductwork

### ◆ 6.3.4 TESTING THE INSTALLATION

Generac recommends testing the installation to be sure adequate cooling airflow is available to the unit before placing the unit into service. If the unit shows signs of overheating, you will need to enlarge the air openings. Never place a unit into service unless you are absolutely certain that cooling and ventilation is adequate.

**NOTE:**

You must test the installation, especially if you bring in air from below the generator set.

Figure 6.13 – Air Inlet in Ventile Skirt

### 6.4 GASOLINE FUEL SYSTEM

The installation of a gasoline fuel system (Figure 2.14) on a recreational vehicle generator set must comply with applicable codes, standards and regulations. The entire fuel system must be completely free of leaks. There must be no possibility of gasoline vapors entering the vehicle interior.

Figure 6.14 – Generator Fuel System

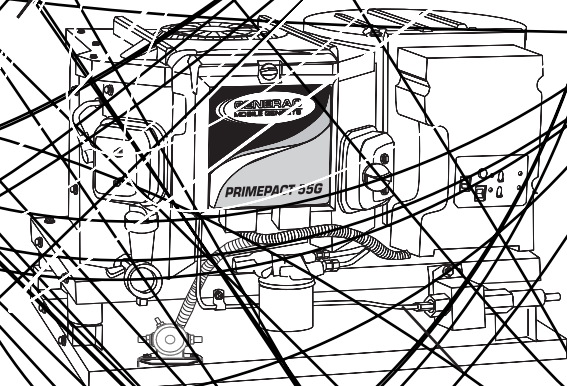

### ◆ 6.3.3 COMPENSATING CORRECTIONS

Such materials as screen and expanded metal can restrict the free flow of air. Compensate for this restriction by making the opening proportionately larger.

Some materials may provide a certain percent "free air inlet area." Other materials may provide up to a 90 percent free air inlet area. The percentage of free air inlet opening is determined from the material supplier or manufacturer.

To determine the actual opening size required, divide 100 square inches by the percentage of free air inlet area for the material you will use.

For example: If you plan to use a material with an 80 percent free air inlet area, divide 100 by 0.8, which results in 125 square inches. The actual size of air inlet opening in this case is 125 square inches.

**▲ DANGER ▲**

Gasoline is highly flammable, and its vapors are explosive. Comply with all codes, standards and regulations pertaining to gasoline fuel systems used in recreational vehicle generators. Properly install and maintain the fuel system and keep it entirely free of leaks. Gasoline vapors must not enter the vehicle interior.

Factory installed generator fuel system components include (a) fuel filter, (b) 12-volt DC electric pump, (c) engine carburetor, and (d) interconnecting lines and fittings. Connect a fuel supply line to the fuel filter inlet. Use a flexible length of approved fuel hose between the fuel filter inlet connection and rigid fuel lines.

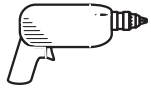

◆ 6.4.1 FUEL TANK

Either the generator must share the vehicle engine's fuel tank, or you must install a separate fuel tank for the generator set. All fuel tanks installed on the vehicle must be constructed, installed and restrained so they comply with applicable codes, standards and regulations.

If the generator is to share the vehicle engine's tank, separate fuel pickup tubes are required for the engine and the generator. Generac recommends that you make the fuel pickup tube 2 to 3 inches (51 to 76 mm) shorter than the vehicle engine's pickup tube. This prevents the generator from depleting the entire fuel supply during prolonged generator operating periods.



⚠ Do NOT tee the generator fuel supply line into the vehicle engine fuel supply line. If this is done, the generator will be starved of fuel when both engines are operating at the same time. Also, while the vehicle engine is not running, generator operation may drain the vehicle engine supply line, making it difficult to start the vehicle engine.

◆ 6.4.2 GENERATOR FUEL SUPPLY LINE

6.4.2.1 Rigid Fuel Lines

Those lines used to supply fuel from a tank to the generator must comply with applicable codes, standards and regulations. The following general rules apply to rigid fuel lines:

- Rigid lines should be of annealed, seamless, drawn aluminum or steel.
- Lines and fittings must comply with SAE J512F, "Standard Automotive Fittings," or with ANSI B126.26 (latest edition).
- Route the fuel line so that at least 2 inches (51 mm) of clearance is maintained between the line and any exhaust system parts.
- Do not attach electrical wiring to fuel lines. Route the wiring so it cannot come into contact with any fuel line.
- Route fuel lines so if they leak, fuel does not drip onto any electrical or exhaust system parts.
- Use nonferrous metal straps without sharp edges to secure fuel lines.

6.4.2.2 Flexible Fuel Line

Use an approved flexible length of fuel hose between the generator fuel inlet connection and rigid fuel lines. This prevents breaking of the line caused by vibration, shifting, settling or movement. The following rules apply:

- The flexible hose must comply with SAE J30B, "Standard for Fuel and Oil Hose." It must be approved for use with gasoline.
- The hose should be at least 6 inches (152 mm) longer than is needed to prevent the hose from rupturing if the generator shifts or settles.

6.5 LP GAS FUEL SYSTEM



⚠ LP gas is highly EXPLOSIVE. The gas is heavier than air and tends to settle in low areas. Even the slightest spark can ignite it and cause an explosion. Only competent, qualified people should be allowed to install, test, adjust or service an LP gas fuel system. Install the optional fuel system in compliance with applicable codes, standards and regulations. After the installation, do not do anything that might render the system in noncompliance with applicable codes and standards.

The LP powered range of generators are fitted with a nonadjustable, factory set system. These systems are tamper-proof to meet 1997 California Air Resources Board requirements for engine emission.

◆ 6.5.1 PARTS NOT INCLUDED IN FUEL SYSTEM

The propane fuel system does NOT include such items as (a) gas tank, (b) gas piping, (c) fittings, (d) valves, and (e) primary regulator, used to store the gaseous fuel and deliver it to the gaseous fuel solenoid (Figure 2.15, Page 29).



⚠ Use only approved components in the fuel supply system. All components must be properly installed in accordance with applicable codes. Improper installation or use of unauthorized components may result in fire or an explosion. Follow approved methods to test the system for leaks. No leakage is permitted. Do not allow fuel vapors to enter the vehicle interior.





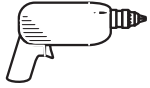

The greater the airflow through the carburetor venturi, the lower the pressure at the venturi throat. The lower the pressure at the venturi throat, the greater the diaphragm movement, and the greater the movement of the regulator valve. The more the regulator valve opens, the greater the gas flow that is proportional to airflow through the generator.

The following facts about the secondary regulator must be emphasized:

- The regulator must be sensitive to venturi throat pressure changes throughout the operating range.
- The regulator must be properly adjusted so it will stop the flow of gas when the engine is not running (no air flow through the carburetor).
- The slightest airflow (and vacuum in the venturi throat) should move the regulator valve off its seat and permit gas to flow.

#### ◆ 6.5.6 FUEL SUPPLY LINES

- LP gas lines must be accessible, but protected against possible damage.
- Do NOT connect electrical wiring to any LP gas fuel line or run wiring alongside the lines.
- Route gas lines away from hot engine exhausts.
- Retain gas lines with metal clamps that do not have sharp edges.
- Install an approved length of flexible hose between the gaseous fuel solenoid valve and rigid fuel supply lines. The flexible line must be nonmetallic, non-organic and nonconductive. It must be approved for use with LP gas.

#### ◆ 6.5.7 EXCESS FLOW VALVE

LP gas tanks should have an excess flow valve, according to NFPA 501C, Paragraph 3-4.4. This valve and the gas lines must be carefully sized so the valve will close when a fuel line is severed or broken. Consult the Natural-LP Gas Association for information and limitations of excess flow valves.

Manual shutoff valves on the supply tank and elsewhere in the system must be fully open when operating the generator. The excess flow valve functions properly only if all valves are fully open.

#### ◆ 6.5.8 LEAKAGE TESTS

Do not place the generator into service until you have properly tested the gas system for leaks. To test the system, you need a separate source of 12 volts DC to open the gaseous fuel solenoid valve.

The leak test must comply fully with NFPA, Paragraph 318. All connections, hoses, valve regulators, fittings, and other fuel system parts must be tested under gas or air pressure of not less than 90 psi (620 kPa), while using soap and water or an equivalent solution to check for leaks. Other approved methods of testing for leaks may be used, if appropriate. DO NOT USE ANY FLAME TO TEST FOR LEAKS.



- ⚠ Gaseous fuel lines between the tank and the secondary regulator are under a positive pressure (about 11 inches water column). Gas pressure at the outlet side of the secondary regulator, however, is a negative pressure and can draw flame inside a line or fitting and cause an explosion.

## 6.6 EXHAUST SYSTEM

The generator exhaust system must be safely and properly installed. Only approved mufflers and other exhaust system parts must be used. A properly installed exhaust system must be vapor tight, quiet and completely safe.



- ⚠ The generator engine gives off DEADLY carbon monoxide gas through its exhaust system. This dangerous gas, if breathed in sufficient concentrations, can cause unconsciousness or even death. Never operate the generator set with the vehicle inside any garage or other enclosed area. DO NOT OPERATE THE GENERATOR IF THE EXHAUST SYSTEM IS LEAKING OR HAS BEEN DAMAGED. SYMPTOMS OF CARBON MONOXIDE POISONING ARE (a) inability to think coherently; (b) vomiting; (c) twitching muscles; (d) throbbing temples; (e) dizziness; (f) headaches; (g) weakness; and (h) sleepiness. IF YOU FEEL ANY OF THESE SYMPTOMS, MOVE INTO FRESH AIR IMMEDIATELY. IF SYMPTOMS PERSIST, GET MEDICAL HELP. Do not operate the generator until its exhaust system has been inspected and properly repaired.



- ⚠ Never tee the generator engine exhaust pipe into the vehicle engine exhaust piping. This causes excessive back pressure on the generator engine. Also, water from one engine can damage the other engine.



### ◆ 6.6.1 MUFFLERS AND SPARK ARRESTORS

This muffler meets code and standard requirements of the U.S. Forest Service. Use only mufflers and parts approved by Generac. Any person(s) installing an unapproved muffler, or an unapproved exhaust system part, or modifying an exhaust system in any way that might cause a hazard, is liable for any damage, injury or warranty expense that might be caused by such unapproved installation or modification.

Failure to provide and maintain a spark arrestor may be in violation of the law. If this generator is used on any forest covered, brush covered or grass covered unimproved land, you must provide a spark arrestor. The vehicle owner or operator must maintain this device in good condition. In the state of California, the preceding is required by law (Section 4442 of the California Public Resources Code). Other states may have similar laws. Federal laws apply on federal lands.

### ◆ 6.6.2 TYPE OF EXHAUST SYSTEM

Two types of exhaust systems for PRIMEPACT series generators are available from Generac. They include the following:

- “Out-the-bottom” exhaust system dimensions are 1 5/16” O.D., model 9742.
- “Out-the-side” exhaust system dimensions are 1” O.D., 18 gauge, models 9743 and 9326.

#### NOTE:

**No matter what type of exhaust kit best fits your recreational vehicle, the mounting base has openings for either “bottom-out” or “side-out” exhaust systems. Use the cover plate provided with the generator to cover the opening you do NOT use.**

### ◆ 6.6.3 EXHAUST SYSTEM SAFETY

- Maintain a clearance of at least 3 inches (76 mm) between exhaust system parts and any combustible material (such as wood, felt, cotton, organic fibers or other like material). If you cannot maintain the 3-inch (76 mm) clearance, locate, insulate or shield the exhaust part(s) so that the temperature of any combustible material is not raised more than 117° F (65° C) above the ambient air temperature.
- Extend the exhaust system at least 1 inch (25 mm) past the outer edge of the vehicle. Do not terminate the exhaust system under the vehicle.
- Terminate the exhaust tailpipe such that exhaust gases will not be drawn back into the generator compartment and recirculated.

- If there is any possibility of the tailpipe or muffler being damaged, protect these damage-prone areas by means of a protective device (such as a skid bar).
- Install the generator exhaust system according to safe automotive practices.
- Use enough exhaust system hangers to prevent any part of the system from being dislocated.
- Use exhaust system parts recommended by Generac. Using unapproved exhaust mufflers and exhaust system parts is the responsibility of the person(s) installing such unauthorized parts.
- Do not terminate the exhaust system under any opening, window or vent that can be opened or is not permanently sealed from the vehicle interior.
- Exhaust piping must be large enough to prevent excessive back pressure on the generator engine.
- Never tee the generator engine exhaust pipe into the vehicle engine exhaust piping. This causes excessive back pressure on the generator engine. Also, water from one engine can damage the other engine.
- Plan exhaust system installation carefully. Comply with all applicable codes, standards and regulations.

## 6.7 ELECTRICAL CONNECTIONS

Be sure to read Section 1.6 on Page 20.

The following general rules apply to electrical connections in a recreational vehicle:

- Qualified electricians who are familiar with applicable codes, standards and regulations should install electrical wiring.
- The wiring should comply with codes, standards and regulations. The National Electrical Code (NFPA 70), and state and local codes apply.
- Switches and circuit breakers should be of a type approved for use in recreational vehicles and must be mounted and installed to prevent damage from road shock.
- Wiring must be of adequate size, have approved insulative qualities and be properly supported.
- Conduit and wire openings into the generator compartment (if used) must be vapor-sealed to prevent entry of flammable, explosive or poisonous gases into the vehicle.

### ◆ 6.7.1 ELECTRICAL JUNCTION BOX

Install an approved, square electrical junction box with a blank cover on the interior or exterior wall of the area you plan to install the generator (NOT on the generator). Route the generator's AC output leads into this junction box through approved flexible conduit. This is the point of first termination for generator AC output leads.

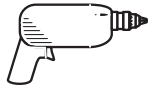

◆ 6.7.2 WIRING

- Wiring should be of stranded copper to reduce the chance that vibration may cause breakage.
- Wire gauge size should be large enough to handle at least 115 percent of the installed generator's rated maximum current.
- If neutral conductors are used, they must be the same size as other leg wires.
- Route power supply conductors from generator AC output leads T1 (red), T2 (white), T3 (black) and the green ground wire through approved flexible conduit to the electrical junction box on the compartment wall.

If flexible metal conduit is used between the generator and the compartment junction box, the conduit end that terminates the compartment junction box must be vapor-sealed. Flexible metal conduit is NOT vapor tight along its entire length.

- From the junction box, route power supply wires through approved conduit to either (a) double-pole, double-throw transfer switch, or (b) approved isolation receptacle. Connecting to a transfer switch or isolation receptacle must prevent vehicle electrical circuits from being connected to two different power supplies at the same time (such as generator and dockside power).
- Conductors must be rated 221° F (105° C) or must be of a larger conductor size.

◆ 6.7.3 GENERATOR AC CONNECTIONS

Generator AC output leads T1 (red), T2 (white) and T3 (black) come out of the generator as shown in Figure 2.17. Leads T1 (red) and T3 (black) are “hot,” while T2 (white) is the grounded neutral lead. There is also a green lead that connects to ground in the junction box of the recreational vehicle.

Figure 6.17 – Generator AC Output Leads

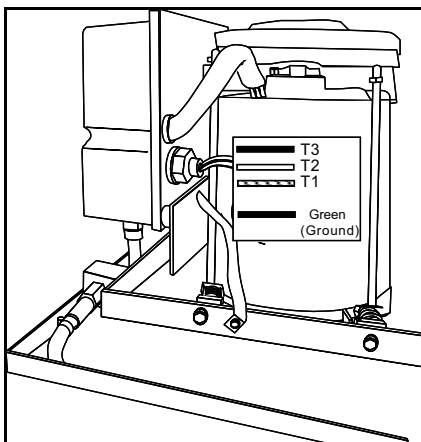

Line T1 (red) to T2 (white) is protected against overload by a 20-amp circuit breaker (CB1). Use this line-to-neutral connection separately to operate 120-volt, single-phase, 60 Hertz, AC loads requiring up to 2,400 watts (3.6 kW) of power. Line T3 (black) to T2 (white) also is protected against overload by a 30-amp circuit breaker (CB2). Use this line-to-neutral connection separately to operate similar loads. However, be sure the total unit load does not exceed the maximum rating of the generator. The neutral line (T2, white) on all units is a grounded neutral.



⚠ **Do NOT connect electrical loads in excess of any circuit breaker rating or you will develop problems with circuit breaker tripping, which causes a loss of AC output. Also, do NOT exceed the generator's rated wattage capacity. Add the watts or amperes of all lighting, appliance, tool and motor loads the generator will operate at one time. This total should be less than the unit's rated wattage/ampere capacity.**

◆ 6.7.4 CONDUIT

Route the connections between the generator and the junction box through approved, flexible conduit. The following general rules apply:

- Cut wiring to the required length and allow extra wire for junction box connections.
- Carefully prepare conduit ends to prevent sharp edges from cutting through wiring insulation.
- Route conduit so it does not interfere with generator movement.
- If you use metallic conduit, vapor seal the end of the conduit where it enters the junction box. Do this because flexible metallic conduit is not vapor proof along its entire length.

◆ 6.7.5 ISOLATING DIFFERENT POWER SOURCES

Connections from the junction box must terminate in a double-pole, double-throw transfer switch (Figure 2.18, Page 33). An alternate method for isolating different power sources is by using an isolating receptacle (Figure 2.19, Page 33). Whichever method you use, you must be certain that both power sources are NOT connected at the same time.

◆ 6.7.6 POWER SUPPLY CORD

The power supply cord must comply with all applicable codes, standards and regulations. It must be large enough to handle the full amperage to which it will be subjected.

◆ 6.7.7 GROUND FAULT CIRCUIT INTERRUPTERS

The National Electrical Code (NFPA 70, 551-7) requires that you install ground fault circuit interrupters (GFCIs) on all external and some internal electrical receptacles. Contact your manufacturer or dealer for recommendations.

Figure 6.18 — Transfer Switch Isolation Method

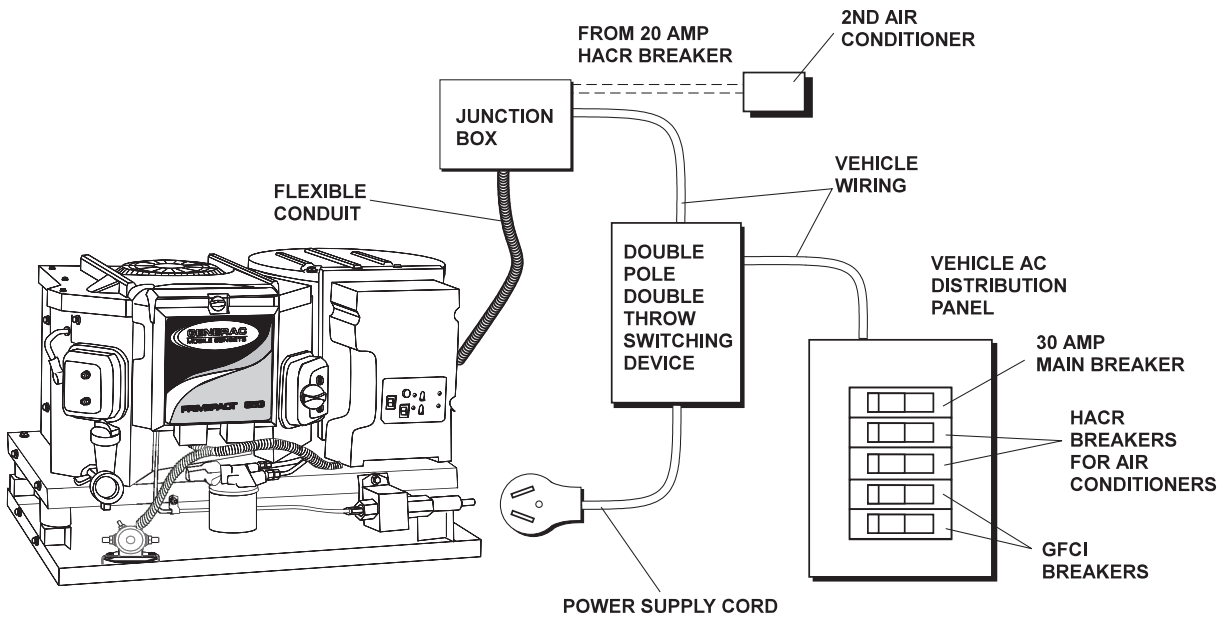
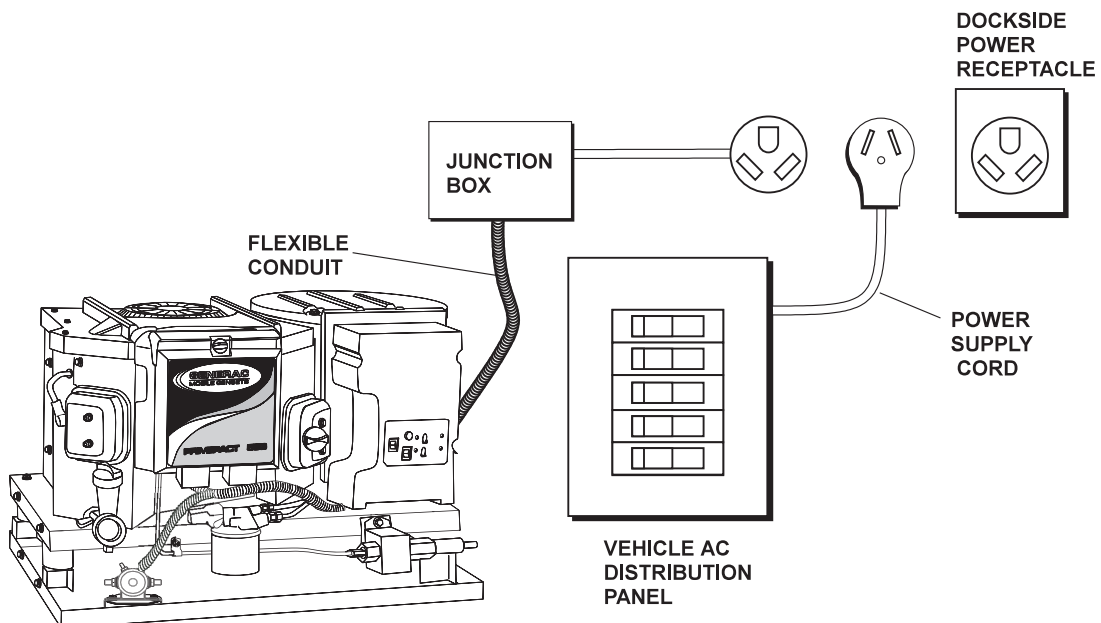
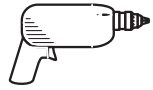

Figure 6.19 — Installation With Isolation Receptacle







## 6.8 BATTERY INSTALLATION

### ◆ 2.8.1 RECOMMENDED BATTERY

Install a battery that meets the following requirements:

- The battery must be a 12-volt, automotive type storage battery.
- For prevailing ambient temperatures above 32° F (0° C), use a battery rated 70 amp-hours and capable of delivering 400 cold-cranking amperes.
- For prevailing ambient temperatures below 32° F (0° C), use a battery rated 95 amp-hours and capable of delivering 400 cold-cranking amperes.

**NOTE:**

If the battery is to be used to power other vehicle accessories, as well as start the generator, you may need a battery with a larger capacity.

### ◆ 6.8.2 BATTERY CABLES

Using battery cables that are too long or too small in diameter may cause a drop in voltage, which causes starting problems. For the best cold weather starting, the voltage drop between battery terminals and the generator connection point should not exceed 0.12 volts per 100 amperes of cranking current.

PRIMEPACT generators are rated at about 100 DC amperes of cranking current.

Select battery cables based on (a) cable length and (b) prevailing ambient temperatures. Generally, the longer the cable and the colder the weather, the larger the cable size must be, as shown in the chart.

CABLE LENGTH in Feet (meters)	CABLE SIZE
0 to 10 (0 to 3)	2*
11 to 15 (3.4 to 4.5)	0
16 to 20 (4.5 to 6)	000

\*For warm weather, use No. 2 cable up to 20 feet.

### ◆ 6.8.3 BATTERY CABLE CONNECTIONS

1. Connect the battery cable from the battery post or terminal indicated by a POSITIVE, POS or (+) to the lug on the starter contactor (Figure 2.20).

**NOTE:**

**Check to be sure the battery cable boot for the starter cable has been installed.**

2. Connect the battery cable from the battery post indicated by a NEGATIVE, NEG or (-) to the frame ground connection (Figure 2.20).
3. Connect cables so the connectors are clean and tight.

Figure 6.20 – Connecting Battery Cables

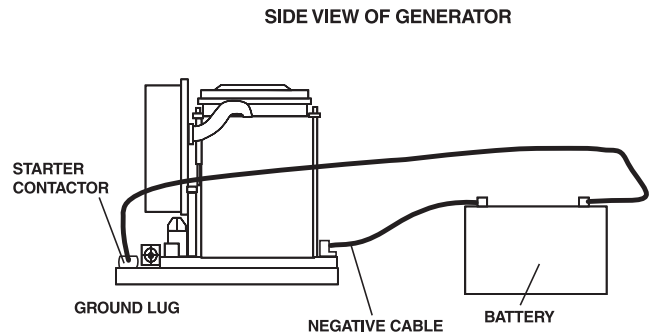

### ◆ 6.8.4 BATTERY COMPARTMENT

Install the generator battery in its own, vented compartment. Place the battery compartment away from any source of heat, sparks or flame.

Provide ventilation openings in the battery compartment. The minimum size of openings should be 2 square inches at the top of the compartment. Mount the battery on a strong, rigid supporting structure, where leaks and spills of battery fluid will not cause damage.

## 6.9 OPTIONAL ACCESSORIES

A plug-in receptacle (Figure 2.21) is provided on the generator set, above the muffler enclosure. Use this receptacle to connect an optional remote-mounted start/stop panel to the generator. Installation of such a panel will permit you to start and stop the generator engine from any convenient location inside the vehicle.

Figure 6.21 – Remote Panel Plug-in Receptacle

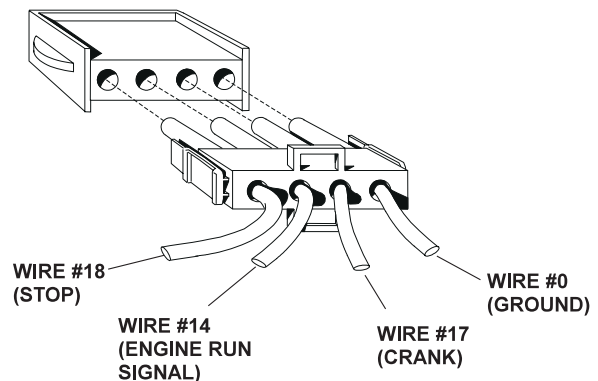

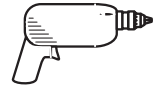

### ◆ 6.9.1 REMOTE PANEL MODELS

The remote panels mount a rocker type start/stop switch, a “Generator Run” advisory lamp and an hourmeter. The hourmeter should be used in conjunction with the maintenance operations found in Part I of this manual.

- Model 004057 includes the remote panel and a 10 foot long, 4 wire harness.
- Model 004184 includes the remote panel and a 30 foot long, 4 wire harness.

## 7.1 POST INSTALLATION TESTS

The air-cooled generator set was factory tested and adjusted. You should not be required to adjust the unit any further except under special circumstances.



### WARNING

- ⚠ **Do not make any unnecessary adjustments. Factory settings are correct for most applications. When making adjustments, however, be careful to avoid overspeeding the engine.**

## 7.2 BEFORE INITIAL START-UP

Before starting, complete the following:

1. Check the engine crankcase oil level and, if necessary, fill to the dipstick “FULL” mark (cross-hatched area) with the recommended oil. Do not fill above the FULL mark.
2. Check the fuel supply. Gas fuel lines must have been properly purged and leak tested in accordance with applicable fuel codes. All fuel shutoff valves in the fuel supply lines must be open.



### DANGER

- ⚠ **If a liquid propane (LP) gas fuel system has been installed, it must be properly tested for leaks before operating the system in compliance with ANSI A119.2/NFPA 501C. No leakage is permitted. You must be sure no gasoline fuel vapors enter the vehicle interior.**

## 7.3 INITIAL START

When you are absolutely certain that the unit has been properly installed and prepared for use, start the engine as follows:

1. Turn off all electrical loads. Do this by setting the generator’s main circuit breakers to their “OFF” (or open) position.
2. Refer to Part I, Section 2.5, “Starting the Generator” (Page 8), for cranking and starting instructions. The engine may require more cranking for initial starting since the fuel lines have to be primed (use of the primer switch will shorten this time).
3. Let the engine warm up for about five minutes to allow internal temperatures to stabilize.
4. Carefully inspect the engine/generator for fuel, oil and exhaust system leaks. Before proceeding to the next step, correct any leakage immediately.
5. When all tests and adjustments at no-load are completed, apply electrical loads and check for proper operation under load. See Section 3.4. Run the unit at least 30 minutes with loads applied.
6. Turn off all electrical loads by setting the generator’s main circuit breakers to their “OFF” (or open) position.
7. Let the unit run at no-load for a few minutes to stabilize internal engine/-generator temperatures. Then, shut down the engine.

### NOTE:

**The generator set was thoroughly tested and adjusted at the factory before shipping. No additional adjustment should be necessary. Only qualified service technicians who have been trained should perform adjustments outlined in this manual.**

## 7.4 TESTING UNDER LOAD

Apply electrical loads equal to about 75 to 100 percent of the unit’s rated wattage/ampere capacity.

Let the unit run at least 30 minutes with load applied. During this part of the test, check that the unit is not running excessively hot and that adequate cooling airflow is available. You must not allow the unit to overheat during prolonged operation.

### NOTE:

**The generator engine is equipped with a high temperature switch. The switch has normally closed (N.C.) contacts. When the engine temperature is too high, switch contacts close, and the engine shuts down automatically.**

**GENERAC RECOMMENDS THAT YOU TEST THE GENERATOR FOR ADEQUATE COOLING.**

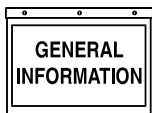

## Section 7 – Post Installation

### PRIMEPACT 55G and 55LP Recreational Vehicle Generators

## 7.5 INSTALLATION CHECKLIST

### ◆ LOCATION AND SUPPORT

- Generator is properly located.
- Generator is properly supported.
- Generator is properly restrained.

### ◆ GENERATOR COMPARTMENT

- Compartment construction is proper.
- Holes/Openings are vapor-sealed.
- Compartment size is correct.
- Compartment is vapor-sealed.
- Sound insulation is correct.
- Floor cutouts are properly completed.

### ◆ COOLING AND VENTILATING AIR

- Airflow is adequate.
- Air inlet opening is correct.
- Compensate for restrictions.
- Check that installation has been tested.

### ◆ GASOLINE FUEL SYSTEM

- Fuel tank complies with all applicable codes.
- Fuel system is properly installed and checked for leaks.

### ◆ OPTIONAL LP GAS FUEL SYSTEM

- Fuel system is properly installed and checked for leaks.
- Pressure at regulator inlet is correct.
- Rated flow of primary regulator is correct.
- All parts are properly installed.
- Fuel system is properly tested/adjusted.

### ◆ EXHAUST SYSTEM

- Exhaust system complies with all applicable codes.
- Exhaust system is properly and safely installed.

### ◆ ELECTRICAL CONNECTIONS

- Connections comply with local code requirements and all National Electrical Codes.
- Junction box is properly installed.
- Wiring meets all standards.
- All connections are correct.
- Conduit is properly installed and sealed.
- Generator is properly bonded to the vehicle.

### ◆ BATTERY INSTALLATION

- Recommended battery is installed.
- Recommended cables are installed.
- Cables are clean and tight.
- Cables are connected properly.
- Proper ventilation is provided.
- Terminals are coated with anti-corrosion grease, and terminal covers are positioned.

### ◆ OPTIONAL ACCESSORIES

- Check that remote start/stop panels (if used) are installed properly.
- Check that hourmeter kit (if used) is installed properly.
- Check that any other options and accessories (if used) are installed properly.

### ◆ POST INSTALLATION TESTS

- Check that all tests are completed properly.

**DATE OF INSTALLATION** \_\_\_\_\_

**NAME OF INSTALLER** \_\_\_\_\_

**SIGNATURE OF INSTALLER** \_\_\_\_\_



## 8.1 TROUBLESHOOTING GUIDE

PROBLEM	CAUSE	CORRECTION
Engine won't crank.	<ol style="list-style-type: none"> <li>15 amp fuse blown.</li> <li>Loose, or corroded or defective battery cable(s).</li> <li>Battery is discharged or defective.</li> <li>Defective starter contactor.</li> <li>Defective starter motor.</li> <li>Defective Start/Stop switch</li> <li>Defective Engine Control Board</li> </ol>	<ol style="list-style-type: none"> <li>Replace blown fuse.</li> <li>Tighten, clean or replace, as necessary.</li> <li>Recharge or replace battery.</li> <li>Replace starter contactor.</li> <li>Replace starter motor.</li> <li>Replace switch</li> <li>Contact an authorized service dealer.</li> </ol>
Engine cranks, won't start.	<ol style="list-style-type: none"> <li>Out of fuel.</li> <li>Fuel shutoff valve is closed.</li> <li>Fuel pump not operating.</li> <li>Automatic choke not operating properly.</li> <li>Engine is flooded.</li> <li>Fuel filter is clogged.</li> <li>Engine spark plugs defective.</li> <li>Bad ignition magneto on engine.</li> <li>Bad carburetor.</li> <li>Dirty air cleaner.</li> </ol>	<ol style="list-style-type: none"> <li>Refill fuel tank.</li> <li>Open fuel shutoff valve(s).</li> <li>Repair or replace pump.</li> <li>Repair, replace or adjust.</li> <li>Wait 5-10 minutes; try again.</li> <li>Replace filter if clogged.</li> <li>Clean, regap or replace as needed.</li> <li>Replace if defective.</li> <li>Adjust, repair or replace.</li> <li>Clean or replace as needed.</li> </ol>
Engine starts hard, runs rough.	<ol style="list-style-type: none"> <li>Dirty engine air cleaner.</li> <li>Automatic Choke sticking.</li> <li>Defective spark plugs.</li> <li>Defective ignition magneto.</li> </ol>	<ol style="list-style-type: none"> <li>Clean or replace as needed.</li> <li>Free choke linkage as needed.</li> <li>Clean, regap or replace.</li> <li>Replace it if defective.</li> </ol>
Engine starts, then shuts down.	<ol style="list-style-type: none"> <li>Engine oil level is low.</li> <li>Bad low oil pressure switch.</li> <li>Defective High Temp Switch</li> <li>Water in fuel.</li> </ol>	<ol style="list-style-type: none"> <li>Add oil as needed.</li> <li>Replace, if bad.</li> <li>Replace Switch, if bad.</li> <li>Drain fuel tank and refill.</li> </ol>
No AC output voltage.	<ol style="list-style-type: none"> <li>Main breaker(s) open.</li> <li>Transfer switch (if so equipped) is set to wrong position.</li> <li>Failure in vehicle electrical system.</li> <li>Generator component failure.</li> </ol>	<ol style="list-style-type: none"> <li>Close main breaker(s).</li> <li>Reset transfer switch.</li> <li>See vehicle manual.</li> <li>Contact an authorized service facility.</li> </ol>

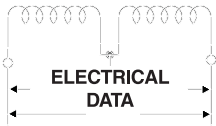

## Section 9 – Electrical Data

### PRIMEPACT 55G and 55LP Recreational Vehicle Generators Electrical Schematic – Drawing No. D3148-A

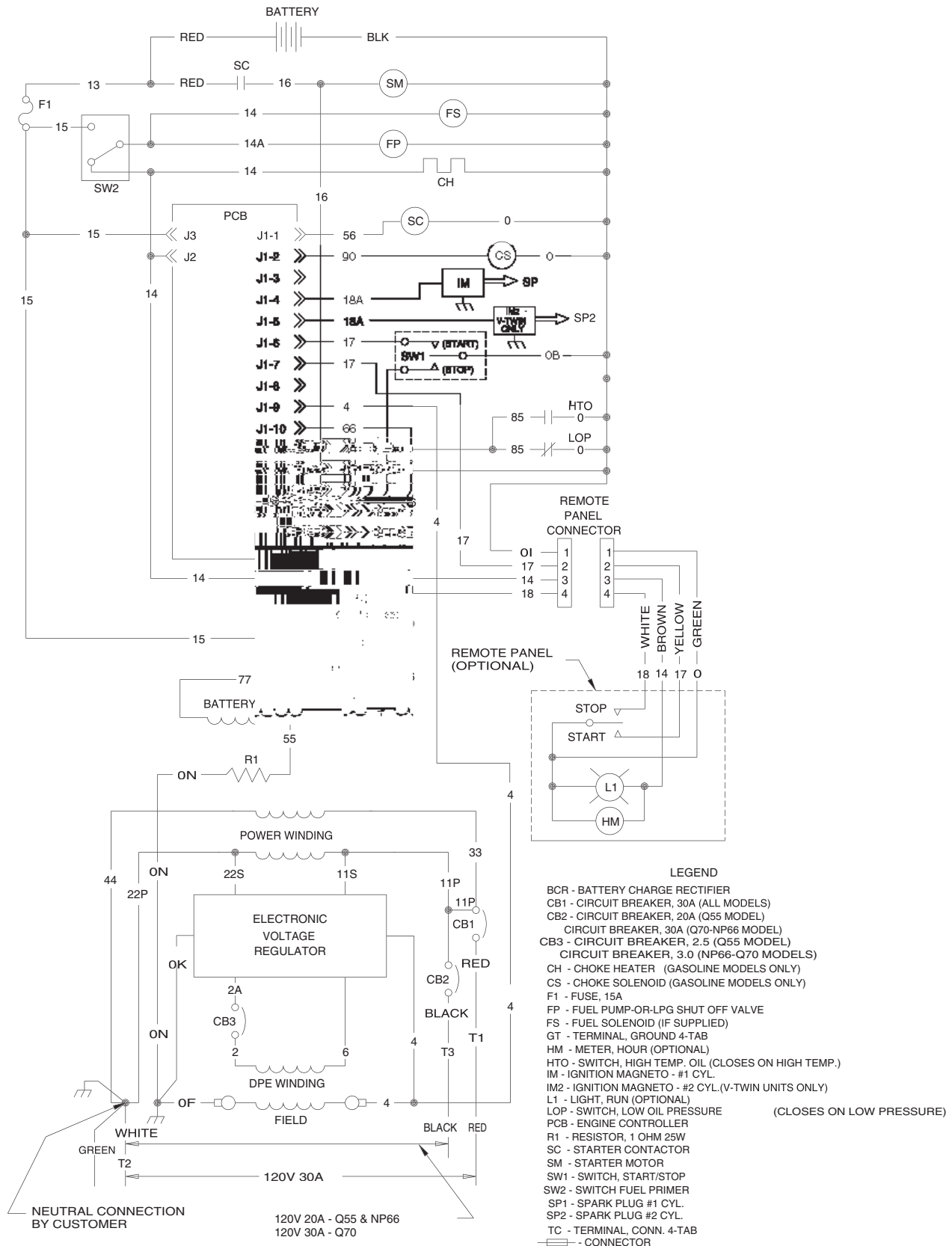





**Section 10 – Exploded Views and Parts Lists**

**PRIMEPACT 55G and 55LP Recreational Vehicle Generators  
Sheet Metal – Drawing No. D3150-A**

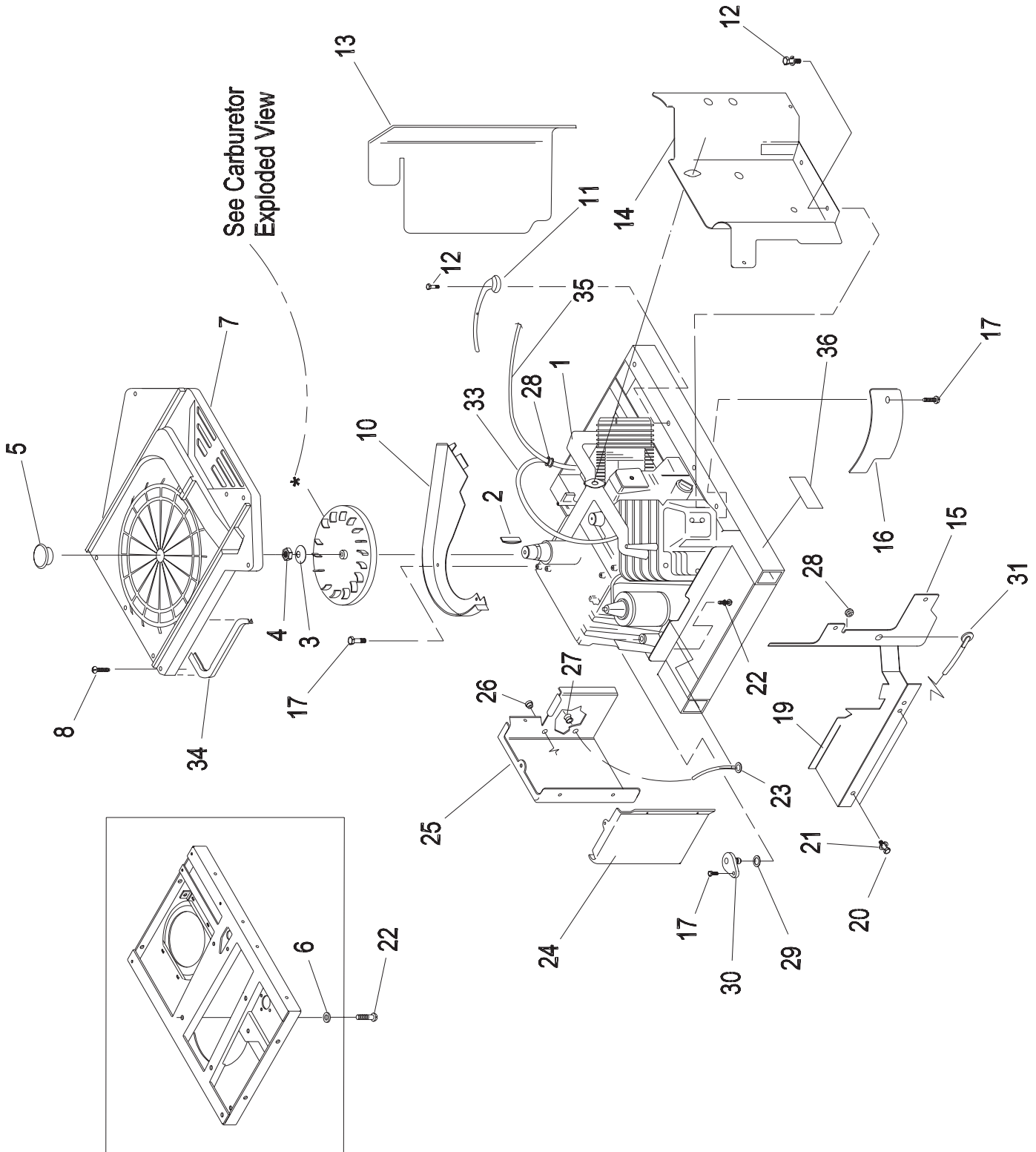

**Section 10 – Exploded Views and Parts Lists**  
**PRIMEPACT 55G and 55LP Recreational Vehicle Generators**  
**Sheet Metal – Drawing No. D3150-A**



ITEM	PART NO.	QTY.	DESCRIPTION
1	-----	1	SEE ENGINE EXPLODED VIEW of ENGINE
2	099258	1	KEY-WOODRUFF 6 x 22MM
3	067198N	1	BEVELLED WASHER
4	067890	1	HEX NUT
5	087865	1	PLUG, FLYWHEEL ACCESS
6	0A4456	1	3/8" SPECIAL LOCK WASHER
7	086313	1	HOUSING, ENGINE TOP
8	056893	23	SCREW (CRIMPTITE) NO. 10-24 x 1/2"
10	087750	1	SCROLL, FLYWHEEL
11	074916	1	COVER, BASE CYL. #2
12	074908	9	SCREW (TAPTITE) M5 x 10MM
13	073190	1	WRAPPER CYL. #2
14	078858	1	COVER, VALLEY
15	078859	1	WRAPPER, CYL. #1
16	074902	2	WRAPPER, BARREL
17	066476	4	HHCS/LW-M6 x 1.0 x 12MM
19	073191	1	COVER, BASE CYL. #1
20	042907	2	CAPSCREW, HEX HD.-M8 x 1.25 x 16MM
21	022129	2	LOCK WASHER-M8
22	075246	4	SCREW (TAPTITE) 3/8"-16 x 1-1/4"
23	0742600133	1	WIRE ASSEMBLY-NO, 16
24	074900	1	STARTER COVER
25	073186	1	WRAPPER, CRANKCASE
26	081108	1	BUSHING, SNAP
27	022717B	1	GROMMET -RUBBER
28	022717A	3	GROMMET -RUBBER
29	067866A	1	O-RING
30	077001A	1	PLUG, OIL FILL
31	073132	2	BOOT, SPARK PLUG
33	087858A	1	GROUND WIRE ASSEMBLY-CYL. #1
34	029289	2FT.	FOAM TAPE
35	087858B	1	GROUND WIRE ASSEMBLY-CYL. #2
36	050277	1	OIL DRAIN DECAL

**PARTS  
LISTS**

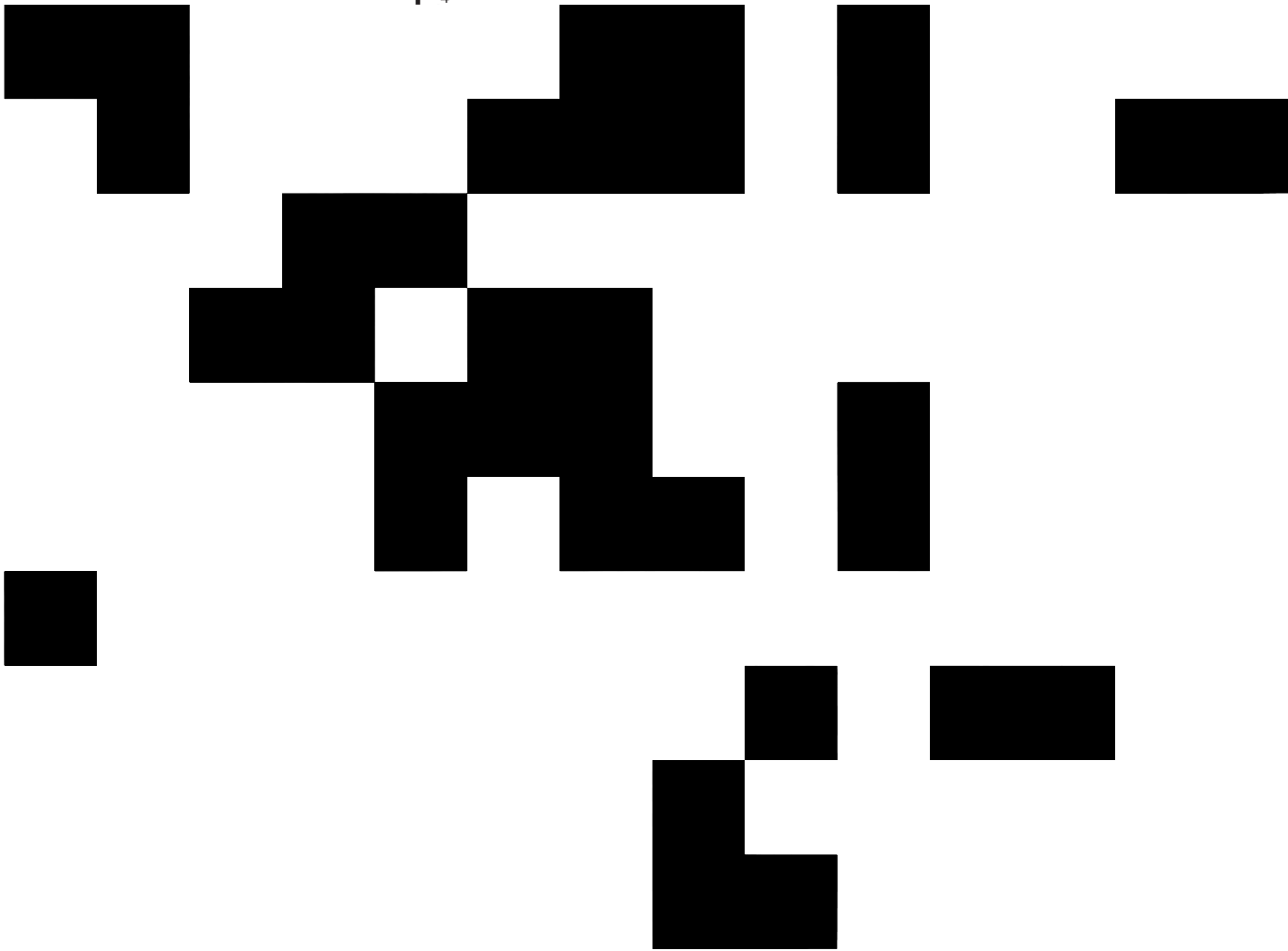
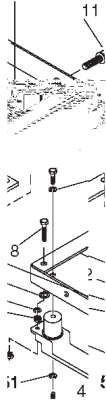

**ITEM PART NO. QTY. DESCRIPTION**

---

1	086318	1	BASE, MOUNTING
2	090141	1	GROUND CABLE
3	046911	4	MOUNT VIBR 1.50X1.38 X 3/8-16)
4	025017	8	SCREW HHC 3/8-16 X 1/2 G5
5	046526	2	WASHER LOCK M10
6	022129	8	WASHER LOCK M8-5/16
7	072391	2	SKID, RUBBER MOUNT
8	077603	2	SAFETY BOLT 5/16-18 x 3 1/2"
9	022259	2	NUT HEX 5/16-18 STEEL
10	052858	6	NUT LOCK M8





**Section 10 – Exploded Views and Parts Lists**  
**PRIMEPACT 55G and 55LP Recreational Vehicle Generators**  
**Base and Pulleys – Drawing No. D3154-A**

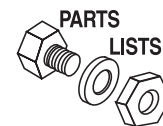

ITEM	PART NO.	QTY.	DESCRIPTION	ITEM	PART NO.	QTY.	DESCRIPTION
1	86318	1	BASE, MOUNTING	47	75711	1	PIPE, OIL DRAIN ADAPTOR
2	90141	1	GROUND CABLE	48	92120	2	NUT LOCK TRIC M6 X 1.0 Y/ZNC
3	46911	4	MOUNT, (RUBBER)	49	D1227	1	STARTER CONTACTOR
4	25017	8	SCREW HHC 3/8-16 X 1/2 G5	50	D1741	2	BOOT, STARTER CONTACTOR
5	46526	2	WASHER LOCK M10	51	24114	2	NUT HEX 5/16-24 STEEL
6	22129	8	WASHER LOCK M8-5/16	52	D1741A	1	BOOT, BATTERY CABLE
7	72391	2	SKID, RUBBER MOUNT	53	22152	2	WASHER LOCK #10
8	77603	2	SAFETY BOLT 5/16"-18 x 3-1/2"	54	22158	2	NUT HEX #10-32 STEEL
9	22259	2	NUT HEX 5/16-18 STEEL	55	133-74260	1	CABLE, STARTER
10	52858	6	NUT LOCK M8	56	73179	1	OIL FILTER SUPPORT
11	51730	2	SCREW HHC M8-1.25 X 60 G8.8	57	70185	1	FILTER, OIL (FRAM#PH3614)
12	29459	2	SPRING, BELT TENSION	58	A8584	1	10 PSI-SWITCH, OIL PRESSURE
13	75215	2	WASHER, SPRING CNTR	59	74948	3	FITTING COMP 5/16X1/8 SLF-ALGN
14	73146	4	SLIDE (NYLON)	60	74950	1	TUBE, OUTER OIL
15	75209	2	SUPPORT, NYLON SLIDE	61	74951	1	TUBE, INNER OIL
16	73174	1	MANIFOLD, EXHAUST	62	73134	1	ADAPTOR, OIL FILTER ADAPTER
17	79678	2	RING, SEALING	63	38750	3	SCREW HHC M6-1.0 X 30 G8.8
18	40976	4	SCREW SHC M8-1.25 X 20 G12.9	64	74949	1	ELBOW 90D TUBE CMP 5/16X1/8NPT
19	72383	2	GASKET, COLLECTOR PAN	65	68548	1	GASKET, OIL FILTER ADAPTER
20	90859	1	COVER PLATE -EXTERNAL	66	C4006	1	CABLE,BATTERY
21	75224-B	1	PULLEY, ENGINE	67	29289	--	TAPE ELEC NON-UL FOAM 1/16X1/2
22	73106-B	1	PULLEY, ALT.	68	22131	1	WASHER FLAT 3/8 ZINC
23	75216	1	BELT (POLY V 4L)-40"	69	75281	1	SWITCH, HIGH TEMPERATURE
24	49451	1	WASHER FLAT SPECIAL .406 I.D.	70	C1085	2	SCREW PPHM M3-0.5 X 8
25	42633	1	SCREW HHC 3/8-24 X 1 G5	71	43182	2	WASHER LOCK M3
26	77017	1	GUIDE, BLOWER HOUSING	72	45756	9	SCREW TAPTITE M6X10 YEL CHR
27	73118	1	SCREW HHC 3/8-24X2-1/4 G8	73	75237	4	WASHER, SPRING RETAINER
28	74906	5	SCREW TAPTITE M6X20 BP	74	D1624	1	BOOT, OIL PRESSURE SWITCH
30	72375	1	HOUSING, BLOWER	75	75474	1	BOOT, TEMPERATURE SWITCH
31	73185	1	SPACER ROLL 2.36X.230X.042 BRZ	76	90800	1	ELBOW, EXHAUST
32	22097	7	WASHER LOCK M6-1/4	77	94670	1	EXHAUST CLAMP
33	77682	1	SCREW HHC M5-0.8 X 80 G8.8	78	75226	1	COVER, AIR
34	75242	4	SPRING, GENERATOR SET MT	79	56893	23	SCREW CRIMPTITE #10-24 X 1/2
35	49813	2	NUT HEX M6 -1.0 G8 YEL CHR	80	75229	1	SLIDE PAN, GASKET
36	45757	2	SCREW HHC M6-1.0 X 25 G8.8	81	D3158	1	SLIDE PAN
37	A5802	1	TINNERMAN CLIP	82	79246	6	CAPSCREW, HEX HEAD- M6-1.00 x 16mm WITH LOCK WASHER
38	22413	1	SCREW HHC 1/4-20 X 1 G5	83	22473	7	WASHER FLAT 1/4 ZINC
39	22145	2	WASHER FLAT 5/16 ZINC	84	67210	1	DECAL-GROUND
40	22237	8	WASHER LOCK 3/8	85	72384-C	1	COVER, EXHAUST OUTLET
41	A8475	1	WASHER SPECIAL LOCK M5	86	23897	6	WASHER FLAT #10 ZINC
42	26925	1	PLUG STD PIPE 3/8 STEEL SQ HD	87	77643	1	GASKET, EXHAUST OUTLET
43	75710-A	1	TUBE, OIL FILL AND DRAIN	88	81105	2	FLANGE NUT, (SPECIAL) 5/16"-18
44	74958	1	CAP & DIPSTICK ASSEMBLY	89	90088	1	CLAMP VINYL .25 X .28 Z
45	67871	1	O-RING, CAP	90	A1658	2	LOCKWASHER, SPECIAL 1/4"
46	A5508	1	OIL FILL TUBE GASKET				

**PARTS  
LISTS**

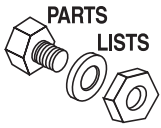
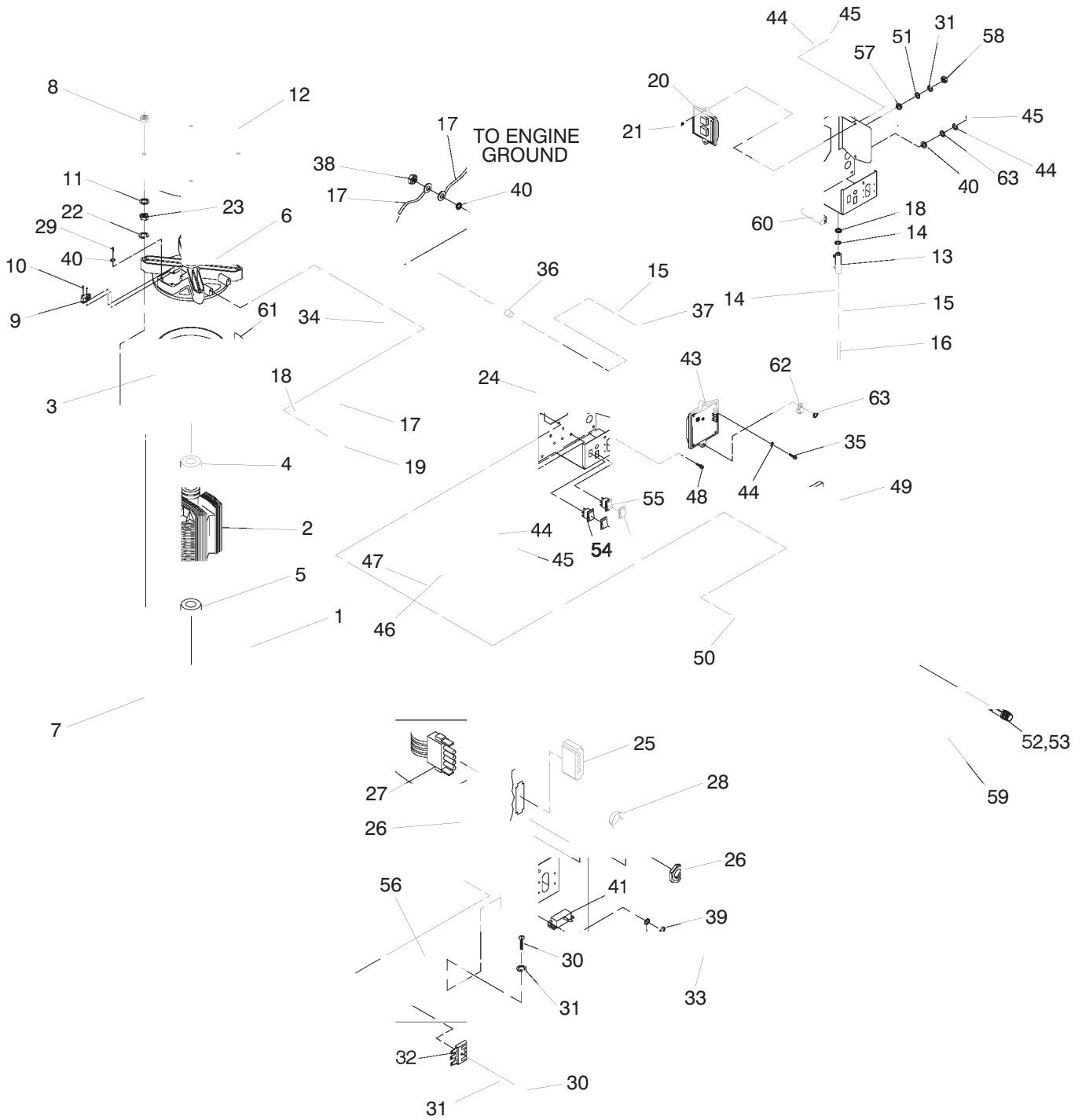
ITEL 43816326096180RYNDESDESCRIPTION7

**Section 10 – Exploded Views and Parts Lists**

**PRIMEPACT 55G and 55LP Recreational Vehicle Generators  
Exploded View - Engine Common Parts – Drawing No. 079216-G**



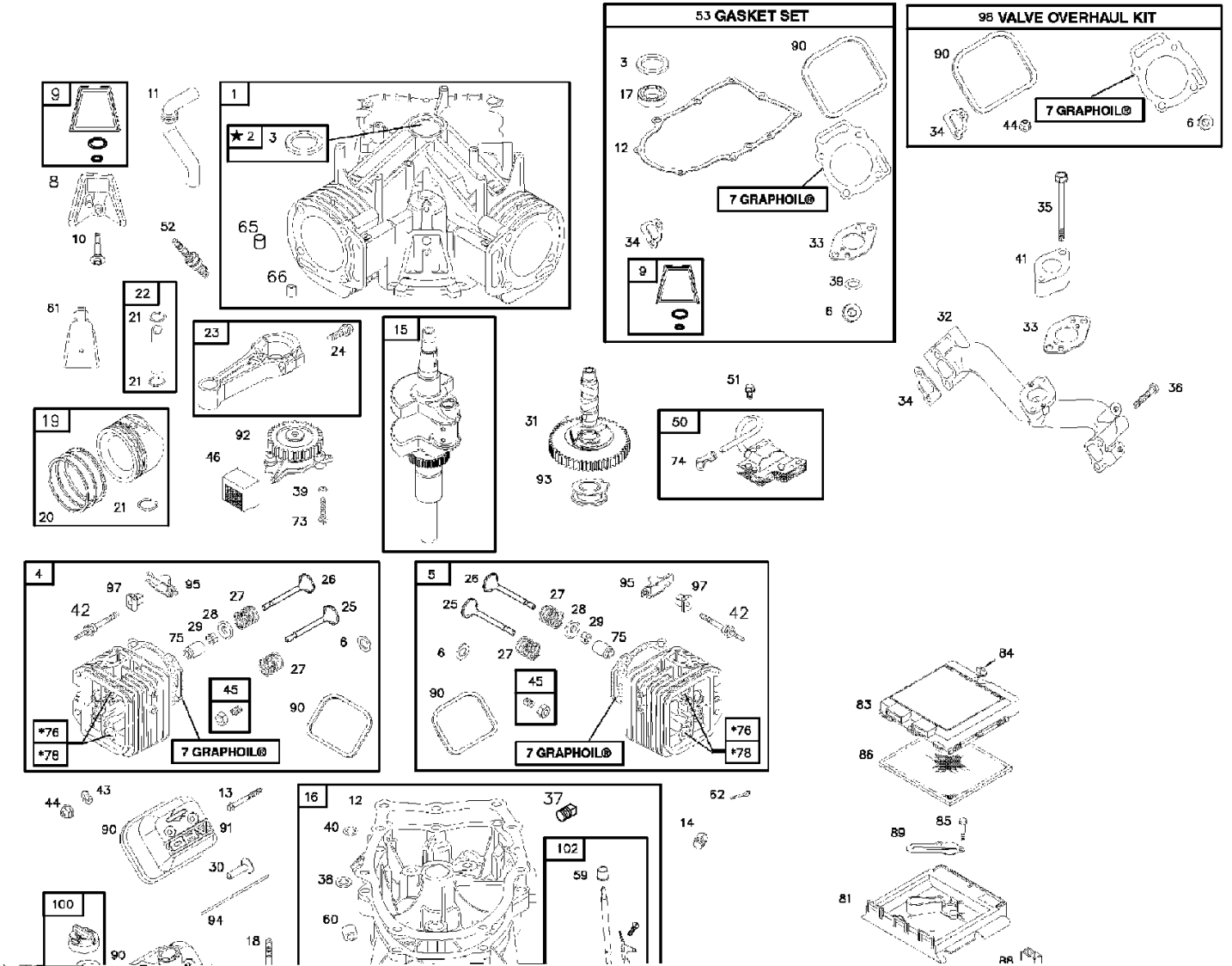

**Section 10 – Exploded Views and Parts Lists**  
**PRIMEPACT 55G and 55LP Recreational Vehicle Generators**  
**Exploded View - Engine Common Parts – Drawing No. 079216-G**

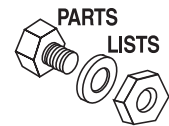

ITEM	PART NO.	QTY.	DESCRIPTION	ITEM	PART NO.	QTY.	DESCRIPTION
1	069331	1	CYLINDER ASSEMBLY	43	075253	4	WASHER VALVE COVER SEAL
2	069333	1	SLEEVE BEARING	44	067885	4	M6 NYLON NUT
3	067805	1	OIL SEAL	45	075254	4	VALVE ADJUST SCREW
4	0851100101	1	NO. 1 CYLINDER HEAD ASSEMBLY	46	070535	1	OIL SCREEN
5	0851100102	1	NO. 2 CYLINDER HEAD ASSEMBLY	47	0C2881	1	STARTER MOTOR (NOT SHOWN)
6	070169	4	SEALING WASHER	50	067891	1	IGNITION COIL
7	069332	2	CYLINDER HEAD GASKET	51	075236	4	IGNITION ARMATURE SCREW
8	0851100104	1	BREATHER ASSEMBLY	52	072347	2	SPARK PLUG
9	072315	1	BREATHER GASKET	53	075258	1	ENGINE GASKET KIT
10	089967	1	BREATHER SCREW	57	066480	1	AIR CLEANER GASKET
11	070596	1	BREATHER TUBE	59	072361	1	GOVERNOR SHAFT BUSHING
12	069336	1	OIL SUMP GASKET	60	072362	1	GOVERNOR SHAFT BUSHING
13	069325	8	CYLINDER HEAD BOLT	61	070199	1	BREATHER BAFFLE
14	067888	2	3/8" NPT OIL DRAIN PLUG	62	072366	1	COTTER PIN
15	072334	1	CRANK SHAFT ASSEMBLY	64	072365	1	GOVERNOR SHAFT WASHER
16	075247	1	OIL SUMP ASSEMBLY	65	068555	2	CRANKCASE DOWEL
17	067924	1	OIL SEAL	66	067806	4	CYLINDER HEAD DOWEL
18	067878	9	OIL SUMP BOLT	73	068572	2	OIL PUMP SCREW
19	075248	2	STANDARD PISTON ASSEMBLY	74	075272	2	SPARK PLUG TERMINAL
20	075249	2	STANDARD PISTON RING SET	75	070122	4	VALVE STEM SEAL
21	069327	4	PISTON PIN RING	76	067910	2	INTAKE VALVE SEAT
22	075250	2	PISTON PIN ASSEMBLY	78	067813	4	VALVE GUIDE
23	089972	2	CONNECTING ROD ASSEMBLY	81	070592	1	AIR CLEANER BASE
24	072346	4	CONNECTING ROD BOLT	82	073123	1	AIR FILTER (NOT SHOWN)
25	069316	2	EXHAUST VALVE	83	070593	1	AIR CLEANER COVER
26	069317	2	INTAKE VALVE	84	0C3633	1	AIR CLEANER COVER SCREW
27	067816	4	VALVE SPRING	85	067156	2	AIR CLEANER BASE SCREW
28	069320	4	VALVE SPRING RETAINER	86	069341	1	PRECLEANER ELEMENT
29	070513	4	VALVE KEEPER	88	070597	1	AIR INLET TUBE
30	070584	4	VALVE TAPPET	89	072305	1	BREATHER DEFLECTOR
31	070530	1	CAMSHAFT ASSEMBLY	90	067920	2	VALVE COVER GASKET
32	072358	1	INTAKE MANIFOLD	91	069328	1	VALVE COVER
33	069379	2	CARBURETOR MOUNTING GASKET	92	070547	1	OIL PUMP ASSEMBLY
34	067895	2	INTAKE MANIFOLD GASKET	93	070536	1	GOVERNOR SLIDER
35	070594	2	CARBURETOR MOUNTING BOLT	94	070577	4	PUSH ROD
36	067158	4	INTAKE MANIFOLD MOUNTING BOLT	95	070599	4	ROCKER ARM ASSEMBLY
37	068574	1	1/8" NPT PLUG PIPE	97	070566	4	ROCKER ARM SUPPORT
38	068554A	1	GOVERNOR SHAFT SEAL	98	075271	1	VALVE OVERHAUL KIT
39	068573	1	OIL PUMP O-RING	99	067897	2	EXHAUST GASKET (NOT SHOWN)
40	070506	1	OIL GALLEY O-RING	100	091481	1	GASKET & CAP ASSEMBLY
41	070554	1	CARBURETOR SPACER	101	091480	1	ROCKER ARM COVER
42	070568	4	ROCKER ARM STUD	102	0D1198	1	GOVERNOR CRANK

**Section 10 – Exploded Views and Parts Lists**

**PRIMEPACT 55G and 55LP Recreational Vehicle Generators  
Carburetor – Drawing No. 093753-H**

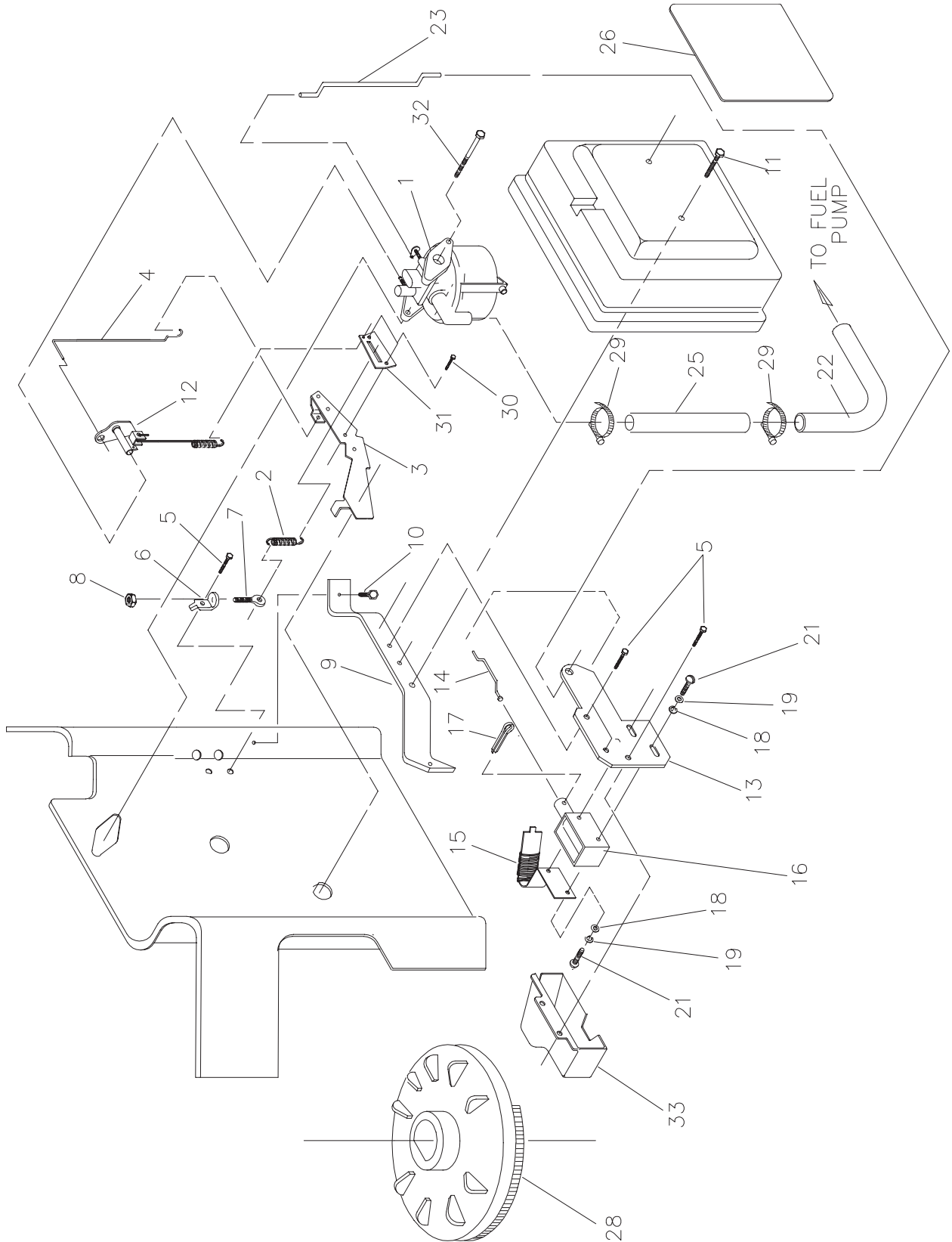

**Section 10 – Exploded Views and Parts Lists**  
**PRIMEPACT 55G and 55LP Recreational Vehicle Generators**  
**Carburetor – Drawing No. 093753-H**



ITEM	PART NO.	QTY.	DESCRIPTION
1	073112B	1	CARBURETOR ASSEMBY
2	074962C	1	SPRING, GOVERNOR - GREEN (PP55G/LP, PP66G/LP)
	074962G	1	SPRING, GOVERNOR - BROWN (PP70G/LP, Q70G)
3	070155	1	LEVER, GOVERNOR
4	070108	1	ROD, GOVERNOR TO CARBURETOR
5	056893	5	SCREW CRMP TIT 10-24 X 1/2
6	074961	1	BRACKET, GOVERNOR ADJUSTER
7	047227	1	SCREW, GOVERNOR ADJUSTER
8	037398	1	NUT, HEX LOCK (NYLON)
9	073131	1	BRACKET, AIR CLEANER SUPPORT
10	066476	2	SCREW, HHSW M6-1.0 X 12
11	070575	2	SCREW, HHSW M6-1.0 X 25
12	070125	1	SPRING, ANTI-LASH
13	073374	1	BRACKET, CHOKE SUPPORT
14	074947	1	ROD, CHOKE CONTROL
15	089473	1	BI-METAL ASSEMBLY, CHOKE
16	091306	1	SOLENOID, CHOKE
17	077091	1	HAIR PIN, COTTER
18	031879	4	WASHER FLAT #4
19	022159	4	WASHER LOCK #4
21	072536	4	SCREW, PPMS #4-40 X 1/4
22	087770	1	TUBE FUEL GASOLINE - 5/16" I.D.
23	074946	1	LINK, CHOKE
25	030340	1	HOSE 1/4" I.D., 4.5" LONG
26	0C2338B	1	DECAL, AIR CLEANER PRIMEPACT 66G
	0C2338	1	DECAL, AIR CLEANER PRIMEPACT 55G
	0C2338D	1	DECAL, AIR CLEANER PRIMEPACT 70G
27	075252	1	KIT, CARBURETOR OVERHAUL-NOT SHOWN
28	0A7782A	1	FLYWHEEL ASSEMBLY
29	040173	2	CLAMP, HOSE (SCREW TYPE)
30	066829	2	RIVET-1/8" DIAMETER x 1/8" LONG
31	075944	1	BRACKET, GOVERNOR SPRING
32	070594	2	SCREW HHC M6-1.0 X 93 WITH LOCK WASHER
33	077075	1	COVER, CHOKE COIL













## Section 12 – Warranty

### PRIMEPACT 55G and 55LP Recreational Vehicle Generators

## CALIFORNIA AND FEDERAL EMISSION CONTROL WARRANTY STATEMENT

### YOUR WARRANTY RIGHTS AND OBLIGATIONS

The California Air Resources Board (CARB) and the United States Environmental Protection Agency (EPA), together with Generac Power Systems, Inc. (Generac), are pleased to explain the Emission Control System Warranty on your new engine.\* New utility, and lawn and garden equipment engines must be designed, built and equipped to meet stringent anti-smog standards for the state of California and the federal government. Generac will warrant the emission control system on your engine for the periods of time listed below provided there has been no abuse, neglect, unapproved modification or improper maintenance of your engine.

Your emission control system may include parts such as the carburetor, ignition and exhaust systems. Generac will repair your engine at no cost to you for diagnosis, replacement parts and labor, should a warrantable condition occur.

### MANUFACTURER'S EMISSION CONTROL SYSTEM WARRANTY COVERAGE:

Emissions control systems on 1997 and later model year engines are warranted for two years as hereinafter noted. If, during such warranty period, any emission-related component or system on your engine is found to be defective in materials or workmanship, repairs or replacement will be performed by a Generac Authorized Warranty Service Facility.

### PURCHASER'S/OWNER'S WARRANTY RESPONSIBILITIES:

As the engine purchaser/owner, you are responsible for the completion of all required maintenance as listed in your factory supplied Owner's Manual. For warranty purposes, Generac recommends that you retain all receipts covering maintenance on your engine. However, Generac cannot deny warranty solely because of the lack of receipts or for your failure to ensure the completion of all scheduled maintenance.

As the engine purchaser/owner, you should, however, be aware that Generac may deny any and/or all warranty coverage or responsibility if your engine, or a part/component thereof, has failed due to abuse, neglect, improper maintenance or unapproved modifications, or the use of counterfeit and/or 'grey market' parts not made, supplied or approved by Generac.

**You are responsible for presenting your engine to a Generac Authorized Warranty Service Facility as soon as a problem occurs.** The warranty repairs should be completed in a reasonable amount of time, not to exceed 30 days.

Warranty service can be arranged by contacting either your selling dealer or a Generac Authorized Warranty Service Facility. To locate the Generac Authorized Warranty Service Facility nearest you, call our toll-free number:

**1-800-333-1322**

**IMPORTANT NOTE:** This warranty statement explains your rights and obligations under the Emission Control System Warranty (ECS Warranty), which is provided to you by Generac pursuant to California and federal law. See also the "Generac Limited Warranties for Generac Power Systems, Inc.," which is enclosed herewith on a separate sheet, also provided to you by Generac. The ECS Warranty applies only to the emission control system of your new engine. If there is any conflict in terms between the ECS Warranty and the Generac Warranty, the ECS Warranty shall apply except in circumstances where the Generac Warranty may provide a longer warranty period. Both the ECS Warranty and the Generac Warranty describe important rights and obligations with respect to your new engine.

Warranty service can be performed only by a Generac Authorized Warranty Service Facility. When requesting warranty service, evidence must be presented showing the date of the sale to the original purchaser/owner. The purchaser/owner shall be responsible for any expenses or other charges incurred for service calls and/or transportation of the product to/from the inspection or repair facilities. The purchaser/owner also shall be responsible for any and/or all damages or losses incurred while the engine is being transported/shipped for inspection or warranty repairs.

**If you have any questions regarding your warranty rights and responsibilities, you should contact Generac at the following address:**

**ATTENTION WARRANTY DEPARTMENT  
GENERAC POWER SYSTEMS, INC.  
P.O. BOX 297  
WHITEWATER, WI 53190**

Part 1



### EMISSION CONTROL SYSTEM WARRANTY

Emission Control System Warranty (ECS Warranty) for 1997 and later model year engines:

- (a) **Applicability:** This warranty shall apply to 1997 and later model year engines. The ECS Warranty Period shall begin on the date the new engine or equipment is purchased by/delivered to its original, end-use purchaser/owner and shall continue for 24 consecutive months thereafter.
- (b) **General Emissions Warranty Coverage:** Generac warrants to the original, end-use purchaser/owner of the new engine or equipment, and to each subsequent purchaser/owner, that each of its engines is ...
- (1) Designed, built and equipped so as to conform with all applicable regulations adopted by the EPA and CARB pursuant to their respective authority, and
  - (2) Free from defects in materials and workmanship which, at any time during the ECS Warranty Period, may cause a warranted emissions-related part to fail to be identical in all material respects to the part as described in the engine manufacturer's application for certification.
- (c) The ECS Warranty only pertains to emissions-related parts on your engine, as follows:
- (1) Any warranted, emissions-related parts that are not scheduled for replacement as required maintenance in the Owner's Manual shall be warranted for the ECS Warranty Period. If any such part fails during the ECS Warranty Period, it shall be repaired or replaced by Generac according to Subsection (4) below. Any such part repaired or replaced under the ECS Warranty shall be warranted for the remainder of the ECS Warranty Period.
  - (2) Any warranted, emissions-related part that is scheduled only for regular inspection as specified in the Owner's Manual shall be warranted for the ECS Warranty Period. A statement in such written instructions to the effect of "repair or replace as necessary" shall not reduce the ECS Warranty Period. Any such part repaired or replaced under the ECS Warranty shall be warranted for the remainder of the ECS Warranty Period.
  - (3) Any warranted, emissions-related part that is scheduled for replacement as required maintenance in the Owner's Manual shall be warranted for the period of time prior to the first scheduled replacement point for that part. If the part fails prior to the first scheduled replacement, the part shall be repaired or replaced by Generac according to Subsection (4) below. Any such emissions-related part repaired or replaced under the ECS Warranty shall be warranted for the remainder of the ECS Warranty Period prior to the first scheduled replacement point for such emissions-related part.
  - (4) Repair or replacement of any warranted, emissions-related part under this ECS Warranty shall be performed at no charge to the owner at a Generac Authorized Warranty Service Facility.
  - (5) When the engine is inspected by a Generac Authorized Warranty Service Facility, the owner shall not be held responsible for diagnostic costs if the repair is deemed warrantable.
  - (6) Generac shall be liable for damages to other original engine components or approved modifications proximately caused by a failure under warranty of any emission-related part covered by the ECS Warranty.
  - (7) Throughout the ECS Warranty Period, Generac shall maintain a supply of warranted emission-related parts sufficient to meet the expected demand for such emission-related parts.
  - (8) Any Generac authorized and approved emission-related replacement part may be used in the performance of any ECS Warranty maintenance or repairs and will be provided without charge to the purchaser/owner. Such use shall not reduce Generac's ECS Warranty obligations.
  - (9) Unapproved, add-on, modified, counterfeit and/or 'grey market' parts may not be used to modify or repair a Generac engine. Such use voids this ECS Warranty and shall be sufficient grounds for disallowing an ECS Warranty claim. Generac shall not be held liable hereunder for failures of any warranted parts of a Generac engine caused by the use of such an unapproved, add-on, modified, counterfeit and/or 'grey market' part.

### EMISSION RELATED PARTS INCLUDE THE FOLLOWING:

- |   |  |
|---|--|
| <ol style="list-style-type: none"> <li>1) Fuel Metering System:             <ol style="list-style-type: none"> <li>1.1) Gasoline carburetor assembly and its internal components (if so equipped).                 <ol style="list-style-type: none"> <li>a) Fuel filter (if so equipped)</li> <li>b) Carburetor gaskets</li> <li>c) Fuel pump (if so equipped)</li> </ol> </li> <li>1.2) LPG carburetion assembly and its internal components (if so equipped).                 <ol style="list-style-type: none"> <li>a) Fuel controller (if so equipped)</li> <li>b) Mixer and its gaskets (if so equipped)</li> <li>c) Carburetor and its gaskets (if so equipped)</li> <li>d) Primary gas regulator (if so equipped)</li> <li>e) LP liquid vaporizer (if so equipped)</li> </ol> </li> </ol> </li> </ol> | <ol style="list-style-type: none"> <li>2) Air Induction System including:             <ol style="list-style-type: none"> <li>a) Intake pipe/manifold</li> <li>b) Air cleaner</li> </ol> </li> <li>3) Ignition System including:             <ol style="list-style-type: none"> <li>a) Spark plug</li> <li>b) Ignition module</li> </ol> </li> <li>4) Catalytic Muffler Assembly (if so equipped) including:             <ol style="list-style-type: none"> <li>a) Muffler gasket</li> <li>b) Exhaust manifold</li> </ol> </li> <li>5) Crankcase Breather Assembly including:             <ol style="list-style-type: none"> <li>a) Breather connection tube</li> </ol> </li> </ol> |
|---|--|

\*Generac engine types covered by this warranty statement include the following:

- 1) Utility
- 2) Lawn and Garden Equipment
- 3) Recreational Vehicle (RV) Generator
- 4) Industrial Mobile (IM) Generator

Part 2



## Section 12 – Warranty

**PRIMEPACT 55G and 55LP Recreational Vehicle Generators**

---

### **GENERAC POWER SYSTEMS' THREE-YEAR LIMITED WARRANTY FOR RECREATIONAL VEHICLE GENERATORS**

**NOTE: ALL UNITS MUST BE INSTALLED BY GENERAC POWER SYSTEMS AUTHORIZED SERVICE FACILITIES.**

For a period of 3 (three) years or 2,000 (two thousand) hours of operation from the date of original sale, whichever occurs first, Generac Power Systems, Inc. (Generac) will, at its option, repair or replace any part which, upon examination, inspection and testing by GeneracTJ74 serac

**GENERAC® POWER SYSTEMS, INC.  
P.O. BOX 8 · WAUKESHA, WI 53187**

**Part No. OD4889**

**Revision 0 [11/09/01]**

**Printed in U.S.A.**

## Free Manuals Download Website

<http://myh66.com>

<http://usermanuals.us>

<http://www.somanuals.com>

<http://www.4manuals.cc>

<http://www.manual-lib.com>

<http://www.404manual.com>

<http://www.luxmanual.com>

<http://aubethermostatmanual.com>

Golf course search by state

<http://golfingnear.com>

Email search by domain

<http://emailbydomain.com>

Auto manuals search

<http://auto.somanuals.com>

TV manuals search

<http://tv.somanuals.com>