

**Read all instructions BEFORE assembly and use of this product.**

**Keep instructions for future use.**

We recommend that you keep these instructions with your Pack 'N Play. A storage pocket has been provided for them on the bottom panel of your unit.

# GRACO®

## Pack 'N Play®

### OWNER'S MANUAL

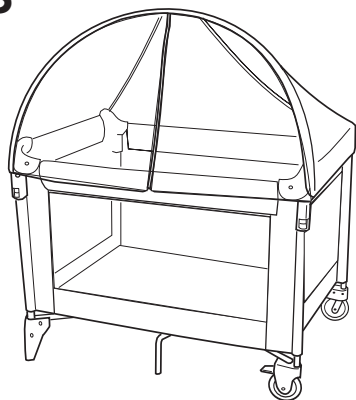

Model No. \_\_\_\_\_

Serial No. \_\_\_\_\_

Dear Customer,  
Please fill in the model and serial numbers above from the label on the center of the bottom of your new Pack 'N Play.

**Model Nos. 9047 & 9747**

### **Congratulations on your purchase of a Graco® Pack 'N Play®!**

Graco is the recognized leader in the design and manufacture of quality baby products. We believe your new Graco® Pack 'N Play® is a wise choice, promising many hours of enjoyment for your baby.

### **Customer Satisfaction**

Our goal is to make every product the best it can be! We are also committed to supporting our products after purchase. If you would like to speak to Graco about your product, please contact our **Customer Service Department at 1-800-345-4109**. Our knowledgeable staff will be ready to answer any questions you may have concerning parts, use, or maintenance. When you call, please have the **model and serial numbers** ready so your call may be processed quickly and efficiently.

Your Pack 'N Play® may be used as a play yard or portable crib. Please read all instructions in this manual and those found on the bottom panel of your unit. Spending time reading the instructions and warnings will help you use your Pack 'N Play safely.

## **⚠ WARNING**

**Failure to follow the instructions could result in injury or death.**

### **Setting Up the Pack 'N Play**

- THIS PRODUCT REQUIRES ADULT ASSEMBLY.
- Keep fingers clear of top corners during set-up. Be sure Pack 'N Play is completely set-up before use. Check that the 4 top rails are completely latched, the center of the floor is pushed down, and the mattress is flat and secured by the VELCRO® strips. Always follow the instructions in the owner's manual to set up the Pack 'N Play.
- Before each use, inspect this product for damaged hardware, loose joints, missing parts or sharp edges. Do not use Pack 'N Play if any parts are missing or broken. Call 1-800-345-4109 for replacement parts or owner's manual. Do not substitute parts.

### **Using the Pack 'N Play**

- The Pack 'N Play can be used as a play yard or a sleeping crib. When used as a play yard, never leave child unattended and always keep child in view. When used as a sleeping crib, you must still provide the supervision necessary for the continued safety of your child.
- Always keep the Pack 'N Play away from hazards in the area that may injure your child.
- Do not add padding or other objects inside the Pack 'N Play that will permit your child to climb out.
- Stop using this product when your child reaches 35 inches (890 mm) in height, or weighs more than 30 pounds (14 kg) or is able to climb out.
- Do not modify Pack 'N Play or add any attachments that are not listed in the owner's manual, including an add-on bassinet.

## **⚠ WARNING**

**Failure to follow the instructions could result in injury or death.**

ard or portable crib. Read and follow the warnings and on the bottom of the Pack 'N Play. The short time you s will help you use your Pack 'N Play properly.

**Follow these warnings and the assembly s could result in serious injury or death.**

### Avoiding Suffocation Hazards

- Unlike cribs that have rigid sides, the Pack 'N Play has flexible sides. As a result, the Pack 'N Play mattress is specially designed to prevent suffocation. The Pack 'N Play mattress has a solid base, a certain length and width, and is less than one inch thick in order to meet safety standards. Using a thicker or a different sized mattress may allow a child's head to get between mattress and the side of the Pack 'N Play causing suffocation.
- To help prevent suffocation from entrapment, **USE ONLY THE MATTRESS PROVIDED BY GRACO.** Never use additional mattress or padding.
- Never use plastic shipping bags or other plastic film as mattress covers not sold and intended for that purpose. They can cause suffocation.
- Do not use a water mattress with the Pack 'N Play.

### Avoiding Strangulation Hazards

- Strings and cords can cause strangulation. Keep strings and cords away from child.
  - Do not place the Pack 'N Play near a window where cords from blinds or drapes can strangle a child.
  - Do not hang strings on or over the Pack 'N Play.
  - Do not place items with a string around a child's neck, such as hood strings, pacifier cords, etc.
  - Do not attach strings to toys.

**This product is not intended for commercial use.**

**ure to follow these warnings and s could result in serious injury or death.**

**Setting up the Pack 'N Play® is easy, but only if you know how.**

## To Set Up Your Pack 'N Play®

### Step 1.

Undo the three VELCRO® straps. Fold VELCRO® straps back onto themselves.

Set mattress aside.

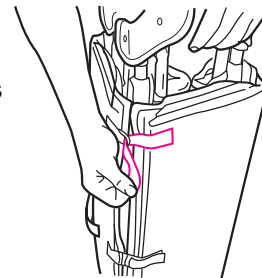

### Step 2.

**IMPORTANT: Leave center of floor UP until all four top rails are latched.**

Grasp the bottom of two of the top rails, and pull up until you hear a "click."

**Be sure top rails have become rigid.**

**If not, pull up again until they are rigid.**

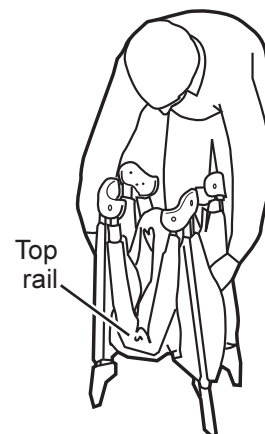

**FOR SMOOTH SETUP and takedown, it's important to remember one thing: the center of the floor must be at least halfway up when locking OR unlocking rails (see picture below). Therefore:**

- **When setting up, lock rails BEFORE lowering center.**
- **When taking down, raise center halfway BEFORE unlocking rails.**

### Step 3.

Pull up the other two sides until they latch.

**NOTE: If top rails do not latch, lift the center of the floor higher. Center of floor must be at least halfway up for the latches to catch properly.**

**Be sure all top rails are rigid.**

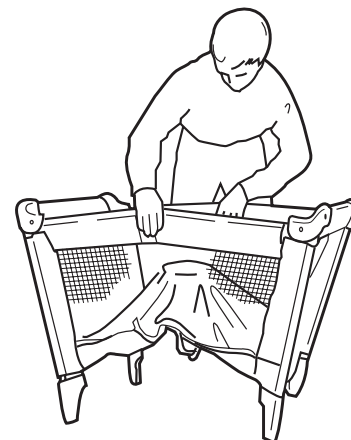

#### Step 4.

Hold one end of the unit up and push the center of the floor down.

At first your Pack 'N Play **may** be like a new pair of shoes. You may need to break it in by slightly stretching the netting and fabric. If the center does not stay down, place some weight (several books) in the center of the unit and let it stand overnight.

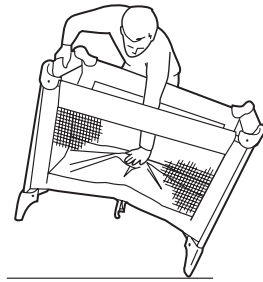

#### Step 5.

**Do not use your Pack 'N Play without the mattress provided by Graco.**

Place the mattress into your unit with padded side up.

Always use your unit with mattress installed soft side up.

Slide the two VELCRO® straps through slots in bottom of Pack 'N Play and fasten to VELCRO® on underside. This will prevent mattress from moving.

Make sure the mattress is installed properly before placing your child in the Pack 'N Play.

Your Pack 'N Play is ready to use.

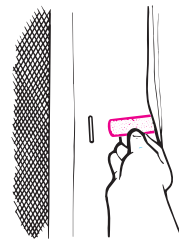
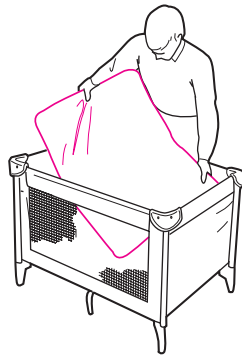

## To Set Up and Use Your Canopy

### **⚠ WARNING**

When properly used, the canopy provides shade for your child. However, your child may be warmer inside the play yard than in a shaded area outside the play yard.

To help prevent build-up of heat inside the play yard and to avoid over-heating your child:

- Turn canopy mesh away from the sun. Keep entire mattress shaded from sunlight at all times.
- Keep play yard well ventilated:
  - Always keep the front mesh panel and one side mesh panel of the play yard open.
  - Never cover the canopy mesh.
  - Never use canopy with an add-on bassinet in the play yard.

As always, use good judgment to protect your child from exposure to heat which can lead to serious injury or death.

**NEVER** leave your child unattended.

**ALWAYS** keep your child in view.

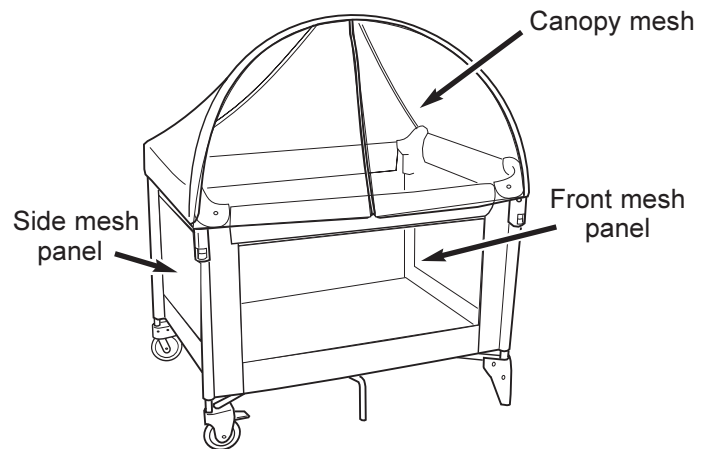

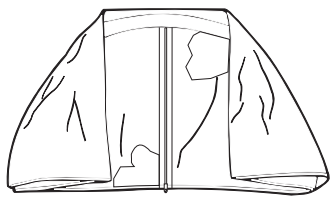

Canopy

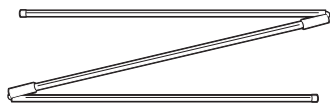

Tubing

### Step 1.

Unfold the tubing and slide the three sections together to form one long tube. The elastic cord in the tubing will hold the pieces together.

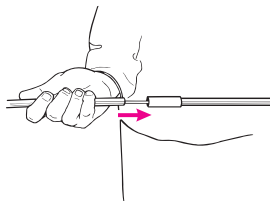

### Step 2.

Slide the long tube into the tunnel in the canopy until both ends stick out of the tunnel 3 or 4 inches. The tunnel is on the shiny side near the netting.

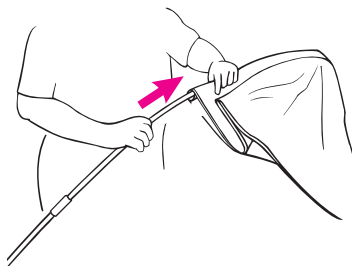

### Step 3.

Push the tube ends into the corner brackets on the Pack 'N Play. Tube end caps will snap into place in the brackets.

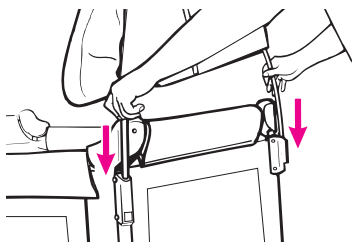

NOTE: The mesh side of the canopy goes on the same side of the unit as the brackets. The shiny side goes on the inside of the unit.

To remove canopy, first **grasp tube firmly** so that it will not spring out. Then push in on end caps to release them from brackets and pull tube ends up.

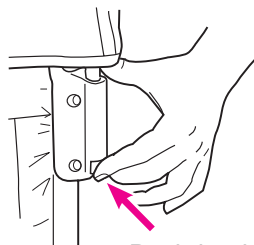

Push in, then up

### Step 4.

Pull the back corners of the canopy over the back corners of the Pack 'N Play and fasten the VELCRO® squares located on the ends of the top rail and back corners of the canopy.

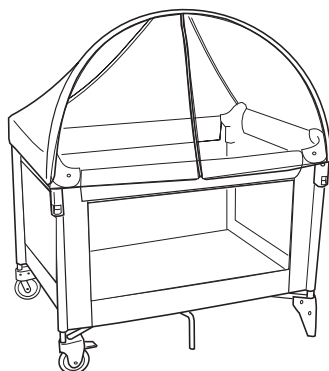

### Step 5.

To help prevent build-up of heat inside the play yard and to avoid over-heating your child:

- Turn canopy mesh away from the sun. Keep entire mattress shaded from sunlight at all times.
- Keep play yard well ventilated:
  - Always keep the front mesh panel and one side mesh panel of the play yard open.
  - Never cover the canopy mesh.

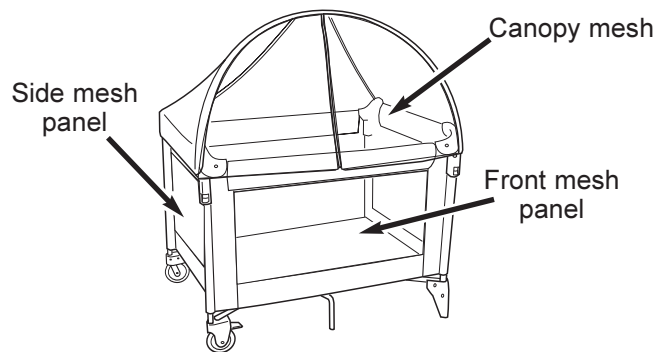

### Maintenance of Canopy:

DO NOT machine wash or dry in a dryer. DO NOT dry clean. Spot clean with a damp cloth and a mild detergent. NO BLEACH.

### Accessory Features

#### BACK FLAP:

You can raise back flap if desired.

Unfasten VELCRO® straps at bottom of flap. Roll flap up.

Fasten in place with snap loops at top.

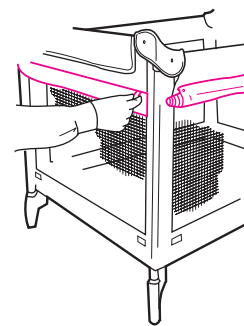

#### TOY BAG:

Toy bag snaps on end of unit. Maximum weight 2 lbs (0.9 kg).

DO NOT machine wash or dry in a dryer. DO NOT dry clean. Spot clean with a damp cloth and a mild detergent. NO BLEACH.

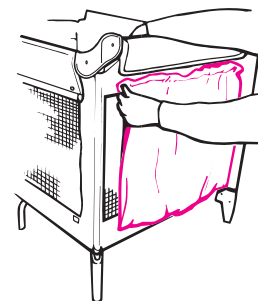

#### WHEELS:

To apply the wheel locks, push DOWN on the lever.

To release the wheel locks, lift UP on the lever.

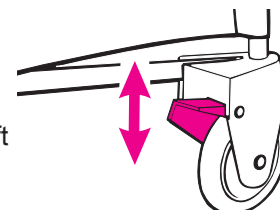

## To Fold Your Pack 'N Play®

### Step 1.

Remove the canopy and lower the back flap. Apply locks on wheels. Release the two VELCRO® straps under the Pack 'N Play, and remove the mattress.

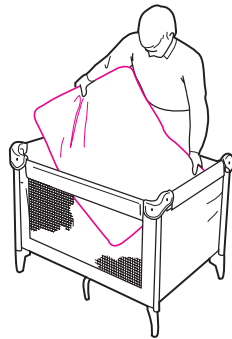

### Step 2.

**IMPORTANT: Raise center halfway BEFORE unlocking rails.**

Grasp center loop as shown and pull up approximately halfway to the top rails.

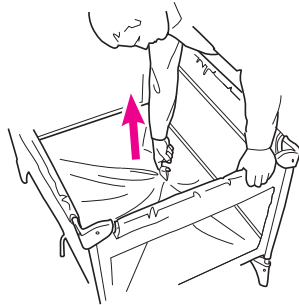

### Step 3.

The top rail has a center piece with two tubes hidden under the fabric. The button on the bottom of the center piece releases the two tubes when it is pushed up.

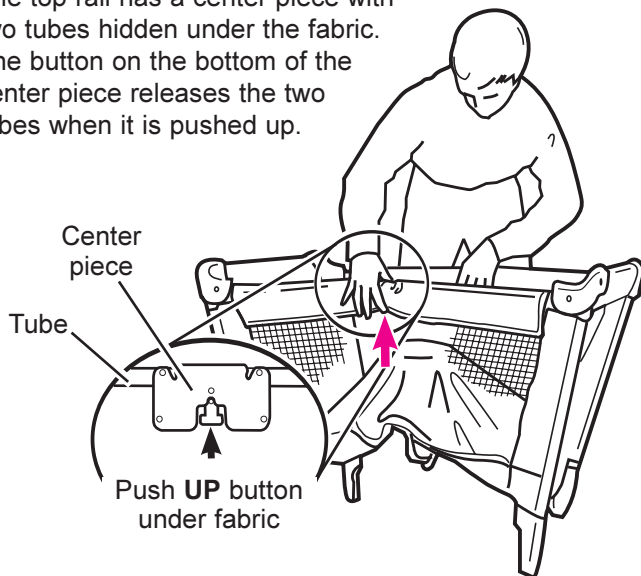

### To fold the top rail:

- Lift up slightly on the top rail.
- Push up on the button located under the symbol  to release the two tubes.
- Push down.

### HINTS:

- If top rails do not unlatch, lift the center of the floor higher.
- Both tubes must be released for the top rail to fold.

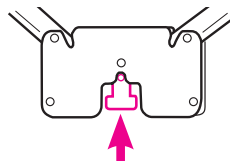

### Step 4.

Pull center up all the way.

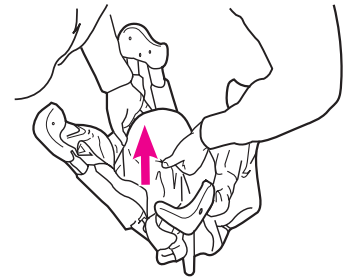

### Step 5.

Gather your unit together. **Do not force.**

If unit will not fold, look for a partially latched top rail. Squeeze the latch button to release the rail.

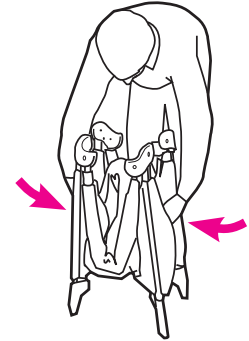

### Step 6.

Find the bottom corner belt loop (only one). This loop is for holding unit and mattress together while carrying.

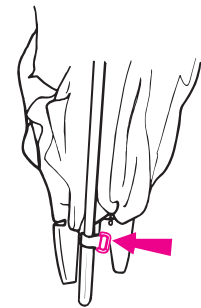

### Step 7.

Wrap the mattress around your unit. Position the mattress so the mattress handle is on the opposite side of the wheels. Fasten together the VELCRO® straps.

Fold the tubes and canopy, and fit the tubes and canopy snugly into the unit. It is not necessary to remove the tube from the canopy. Grasp the tube on either side of a joint and pull apart. Repeat at other joint. Fold the tube and canopy together.

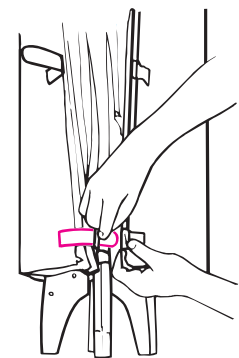



## To Cover Your Pack 'N Play®

Place the Pack 'N Play on the floor with the feet and wheels facing up.

Pull cover over the unit. Be sure the carrying handle attached to the Pack 'N Play mattress is exposed.

Push the plastic end of bag over the wheels and feet of the unit.

Turn the unit over and zip the bag together.

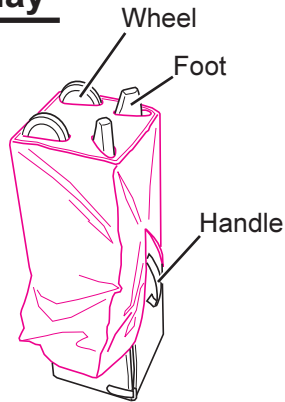

## Replacement Parts

### Instructions for ordering Pack 'N Play® parts:

Complete form below. Your Pack 'N Play model number **MUST** be included on the form to ensure proper replacement parts. Your model number can be found on a label on the center of the bottom of the unit. **Payment must accompany your order.**

Parts List:	Price:*
Mattress .....	\$17.50
Carry bag .....	\$12.00
Canopy .....	\$15.00
Canopy tube .....	\$ 5.00
Canopy bracket .....	\$ 5.00 (each)/\$8.00 (2)
Toy bag .....	\$12.00
Wheels .....	\$ 7.00 (each)/\$10.00 (2)

\* Prices subject to change without notice.

### IF YOU NEED HELP

If you have any questions, please call toll-free:

**1-800-345-4109**

### CARE AND MAINTENANCE

**FROM TIME TO TIME CHECK YOUR PACK 'N PLAY** for worn parts, torn material or stitching. Replace or repair the parts as needed. Use only Graco® replacement parts.

**IF PACK 'N PLAY IS USED AT THE BEACH,** you **MUST** clean sand off your Pack 'N Play, including the feet, before packing it into cover. Sand in top rail lock may damage it.

**TO CLEAN PACK 'N PLAY,** use only household soap or detergent and warm water. **NO BLEACH.**

**TO WASH CARRY BAG AND FITTED SHEET** (on certain models), machine wash in lukewarm water on delicate cycle and drip-dry. **NO BLEACH.**

Return the form below with payment to:  
**GRACO CHILDREN'S PRODUCTS INC.**  
**CUSTOMER SERVICE DEPARTMENT**  
**P.O. BOX 100, MAIN STREET**  
**ELVERSON, PA 19520**

**Model Number**

**SHIP TO:**

(Must be filled in)

Name

- Mattress
- Carry bag
- Canopy
- Canopy tube
- Canopy bracket
- Toy bag
- Wheels

Address

City, State, Zip

( )  
Telephone

Check enclosed  
 (payable to Graco Children's Products Inc.)

Charge to credit card:  
 Visa  
 MasterCard  
 Discover

Total: \_\_\_\_\_ Account #: \_\_\_\_\_

6% sales tax  
 (PA only): \_\_\_\_\_ Expiration date: \_\_\_\_\_

Total amount due: \_\_\_\_\_ Signature: \_\_\_\_\_

## Free Manuals Download Website

<http://myh66.com>

<http://usermanuals.us>

<http://www.somanuals.com>

<http://www.4manuals.cc>

<http://www.manual-lib.com>

<http://www.404manual.com>

<http://www.luxmanual.com>

<http://aubethermostatmanual.com>

Golf course search by state

<http://golfingnear.com>

Email search by domain

<http://emailbydomain.com>

Auto manuals search

<http://auto.somanuals.com>

TV manuals search

<http://tv.somanuals.com>