

LUMEX[®]

A Graham-Field Brand

AltaDyne[®] 750000

ALTERNATING PRESSURE / LOW AIR LOSS MATTRESS SYSTEM



USER MANUAL

Important: Do not operate the Mattress System without first reading and understanding this manual! Save this manual for future use.

Info: The most current version of this manual can be found online at www.grahamfield.com.

750000-INS-LAB-RevC11

CONTENTS

| | |
|--------------------------------------|----|
| INTRODUCTION | 3 |
| INTENDED USE OF THIS DEVICE | 3 |
| CONTRAINDICATION..... | 3 |
| IMPORTANT SAFETY PRECAUTIONS | 4 |
| DANGER | 4 |
| WARNING | 5 |
| NOTICE | 6 |
| EQUIPMENT SYMBOLS | 7 |
| PRODUCT DESCRIPTION..... | 8 |
| PUMP AND MATTRESS SYSTEM..... | 8 |
| PUMP: FRONT..... | 8 |
| PUMP: REAR | 9 |
| PUMP: TOP PANEL | 9 |
| INSTALLATION | 11 |
| UNPACKING | 11 |
| PUMP AND MATTRESS INSTALLATION | 12 |
| OPERATION..... | 14 |
| PRESSURE ADJUSTMENT | 14 |
| QUICK DISCONNECT | 15 |
| TRANSPORT CAP..... | 15 |
| CPR FUNCTION | 15 |
| MAINTENANCE..... | 16 |
| CLEANING | 16 |
| GENERAL MAINTENANCE..... | 16 |
| FUSE REPLACEMENT | 17 |
| AIR FILTER REPLACEMENT | 17 |
| STORAGE | 17 |
| SPECIFICATIONS..... | 18 |
| WARRANTY | 19 |

Graham-Field, Lumex, and AltaDyne are registered trademarks of GF Health Products, Inc.

GF Health Products, Inc. (“Graham-Field”) is not responsible for typographical errors. Packaging, warranties, specifications and products are subject to change without notice.

INTRODUCTION

Use this manual for set-up and operation of the Lumex AltaDyne 750000 Alternating Pressure / Low Air Loss Mattress System. Read all instructions before using the mattress system. Save this manual for future reference.

INTENDED USE OF THIS DEVICE

The intended use of the Lumex AltaDyne 750000 Alternating Pressure / Low Air Loss Mattress System is:

- The treatment of pressure ulcers while optimizing user comfort.
- Pain management as prescribed by a physician.
- As described above, in either a homecare or long term care setting.

Contraindication

⚠ WARNING: DO NOT use this product in the presence of flammable anesthesia. There is a possible fire hazard when this product is used with certain oxygen delivery equipment.

Use nasal cannula, face mask, or 1/2 length oxygen tent to deliver oxygen in the presence of this product. DO NOT use a full length oxygen tent that extends past the top surface of the mattress with this product.

IMPORTANT SAFETY PRECAUTIONS

The safety statements presented in this chapter refer to the basic safety information that should be observed by those using the Alternating Pressure / Low Air Loss Mattress System. There are additional safety statements in other chapters or sections, which may be the same as or similar to the following, or specific to the operations.

- ⚠ **DANGER:** Indicates an imminent hazard situation that, if not avoided, will result in death or serious injury.
- ⚠ **WARNING:** Indicates a potential hazard situation or unsafe practice that, if not avoided, could result in death or serious injury.
- ⚠ **CAUTION:** Indicates a potential hazard or unsafe practice that, if not avoided, could result in minor or moderate personal injury.
- ▲ **NOTICE:** Indicates a potential hazard or unsafe practice that, if not avoided, could result in product or property damage.

Info: Provides application recommendations or other useful information to ensure that you get the most from your product.

DANGER

To reduce the risk of electrocution:

- ⚠ **DANGER:** Always unplug this product immediately after using.
- ⚠ **DANGER:** Do not use this product while bathing.
- ⚠ **DANGER:** Do not place or store this product where it can fall or be pulled into a tub or sink.
- ⚠ **DANGER:** Do not place this product in or drop into water or other liquid.
- ⚠ **DANGER:** Do not reach for a product that has fallen into water. Unplug it *immediately*.

WARNING

To reduce the risk of burns, electrocution, fire, or personal injury:

- ⚠ **WARNING:** Do not leave this product unattended when plugged in.
- ⚠ **WARNING:** Always use close supervision when this product is used by, on, or near children or those who require close supervision.
- ⚠ **WARNING:** Use this product only as intended and described in this manual. Do not use attachments or accessories not recommended by Graham-Field.
- ⚠ **WARNING:** Never operate this product if:
 - a) It has a damaged cord or plug.
 - b) It is not working properly.
 - c) It has been dropped or damaged.
 - d) It has been dropped into water.

Return the product to your Graham-Field equipment provider.

- ⚠ **WARNING:** Keep the cord away from heated surfaces.
- ⚠ **WARNING:** Never drop or insert any object into any opening or hose.
- ⚠ **WARNING:** Never block the air openings of this product or place it on a soft surface, such as a bed or couch, where the openings may be blocked. Keep the air opening free of lint, hair, and other similar particles.
- ⚠ **WARNING:** Connect this product *only* to a properly grounded power outlet.
- ⚠ **WARNING:** Maximum patient weight capacity for this product is 350 lb (159 kg).

⚠ WARNING: Patient entrapment with bed side rails may cause injury or death. The bed frame and its components, including the mattress, bed side rails, head and foot board, bedding, and any accessories added to the bed, can all affect the risk of entrapment. Thorough patient assessment and monitoring are necessary to reduce the risk of entrapment, including establishing whether the use of a bed rail is in the best interest of the patient. Read and understand the User Manual before using this equipment. GF Health Products, Inc. product manuals are available online at www.grahamfield.com.







Visit the FDA's Bed Safety page at www.fda.gov to learn more about the risks of entrapment. It is the responsibility of the facility and provider to be in compliance with these guidelines. Refer to user manuals for beds and rails for additional product safety information.

After any adjustment, repair or service, and before use, ensure all attaching hardware is securely tightened. Bed rails with dimensions different than the original equipment specified by the bed manufacturer may not be interchangeable and may result in entrapment or other injury.

NOTICE

▲ NOTICE: The pump can be used only with the accompanying mattress. Do not use it for any other purpose.

EQUIPMENT SYMBOLS

| | | |
|---|--|--|
|  | Attention! Consult accompanying documents (this manual) | |
|  | “BF”symbol: Indicates that this product is in accordance with the degree of protection against electric shock for type BF equipment | |
|  | Functional earth (for UL only) | |
|  | Class II (for UL only) | |
|  | Disposal of Electrical & Electronic Equipment (WEEE): Do not treat this product as household waste. For more detailed information with regard to returning and recycling this product, please consult your local city office, household waste disposal service, or Graham-Field equipment provider. | |
| For U.S. and Canada only | | |
| E228589 53DG |  | Medical Equipment: Air Pump with respect to electrical shock, fire and mechanical hazards only in accordance with UL60601-1 and CAN/CSA C22.2 No. 601.1 |

PRODUCT DESCRIPTION

PUMP AND MATTRESS SYSTEM

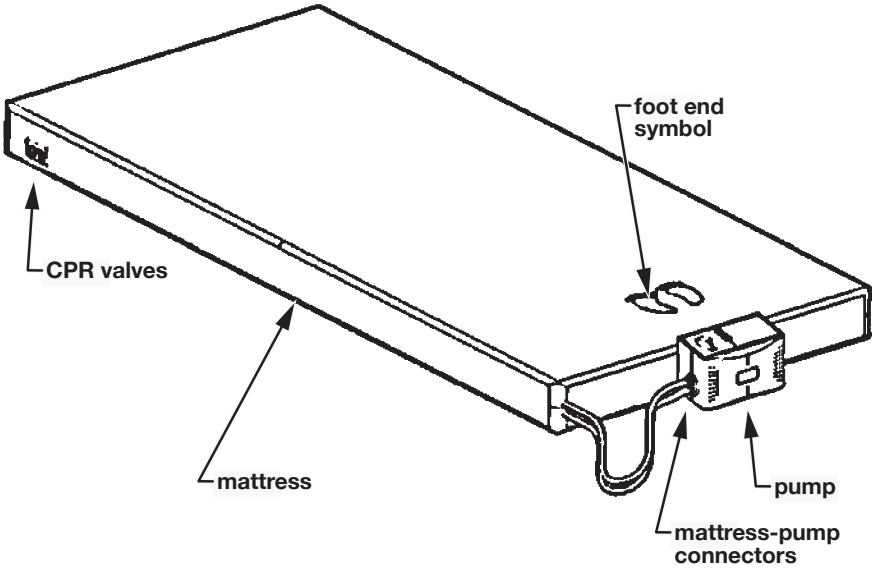

pump and mattress system

Pump: front

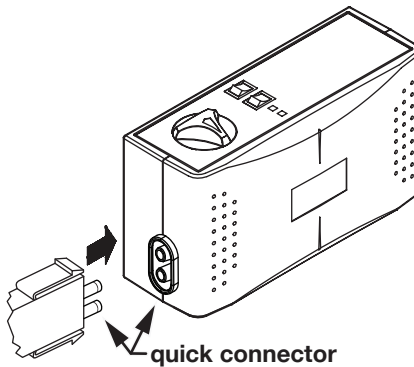

Pump: rear

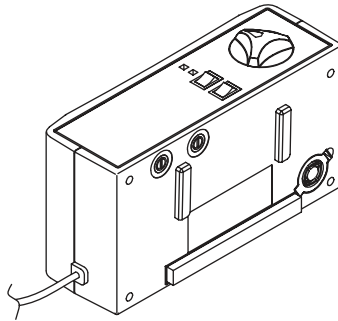

Pump: top panel

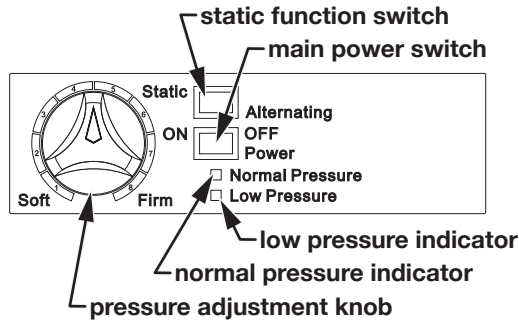

Pressure adjust knob: The pressure adjust knob controls the air pressure output. Turn it clockwise to increase output pressure (firmer); turn it counter-clockwise to decrease air output pressure (softer). Higher pressure output will better support the heavier-weight user. The setting is measured in kilograms (kg). Please consult your physician for an appropriate setting.

Normal pressure indicator: The green **normal pressure LED** illuminates when the pressure inside the air mattress has reached the selected pressure setting.

Low pressure indicator: The yellow **low pressure LED** illuminates when the pressure inside the air mattress is below the selected setting.

Static function switch: Press the **static function switch** to suspend alternating function, if needed; the pressure inside the air tubes will then be adjusted to identical pressure. Press the static function switch again to change back to alternating mode. The static function switch toggles between static and alternating modes.

Main power switch: The main power switch toggles between ON and OFF. When power is ON, either the normal or low pressure indicator illuminates.

INSTALLATION

UNPACKING

1. Before unpacking, check for obvious damage to the carton or its contents. If damage is evident, please notify the carrier and your Graham-Field equipment provider.
2. Remove all loose packing from the carton.
3. Carefully remove all components from the carton.
4. Inspect all components. If damage is evident, please notify the carrier and your Graham-Field equipment provider.

PUMP AND MATTRESS INSTALLATION

1. Place the mattress on top of the bed frame; ensure that the foot end symbol faces up at foot end as shown at right.

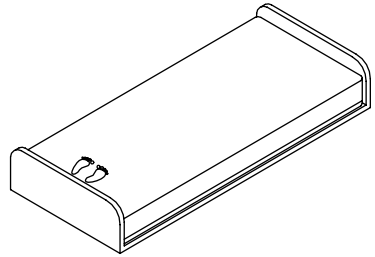

2. Fold open the wire hangers on the back of the pump as shown at right.

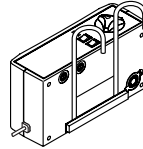

3. Either hang the pump on the bed's foot end as shown at right, or place the pump on a flat surface easily accessible to the user, caregiver, and/or doctor.

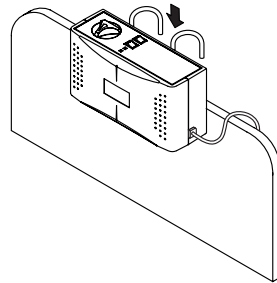

▲ NOTICE: Place the device in a position where the user, caregiver, and/or doctor can access it easily.

4. Connect the mattress-pump air hose quick connector; ensure that the connector has clicked securely into place before continuing.

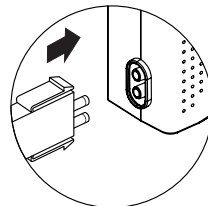

▲ NOTICE: Ensure that the air hoses are not kinked or tucked under the mattress.

- ⚠ WARNING: Locate all cords so that they will not be stepped on, tripped over, or otherwise subjected to damage or stress.**
 - ⚠ WARNING: Do not use a household extension cord if the electrical cord does not reach the power outlet. Use of an improper extension cord could result in fire and electric shock. If an extension cord must be used, use a three conductor cord with ground, properly wired, in good electrical condition, and keep it as short as possible.**
 - ⚠ WARNING: Ensure that the local power voltage is appropriate for the pump unit.**
5. Plug the power cord into a properly grounded electrical outlet.

OPERATION

1. Turn the power switch to the ON position.

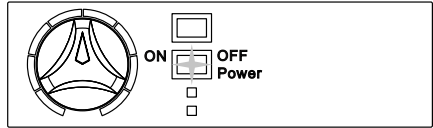

2. Adjust the pressure adjust knob to the maximum position.

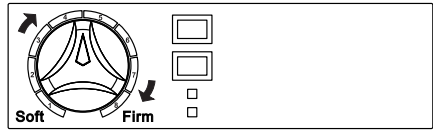

Info: Set the pressure adjust knob to the maximum position for the quickest inflation at set-up; the mattress can then be adjusted to the desired pressure.

3. The pump will begin delivering air into the mattress. While the mattress is filling, the low pressure indicator (yellow LED) will illuminate.

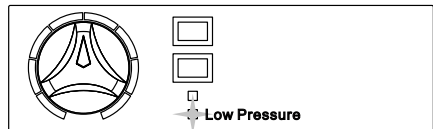

4. When the selected pressure level is reached, the low pressure indicator will de-illuminate, and the normal pressure indicator (green LED) will automatically illuminate.

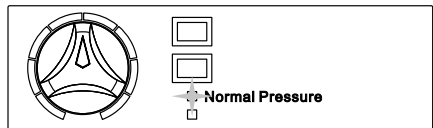

5. Replace all sheets, blankets, and pillows on the bed.

PRESSURE ADJUSTMENT

Generally, a lighter patient will need a lower (softer) setting while a heavier patient will need a higher (firmer) setting, but pressure adjustment must ultimately be based on the patient's *weight distribution*. A short, stocky person may be the same weight as a tall, thin person, but their settings will not be the same. The mattress should be firm enough to support the patient, yet soft enough so the patient will sink down to eliminate pressure points. Test the pressure by placing four fingers below the mattress

under the patient's buttock area; your fingers should just fit. If the fit is too loose, decrease the setting. If your fingers do not fit well, increase the setting two notches firmer. Wait ten minutes and then check again. You should only have to adjust this setting one time per patient. Please consult your physician for an appropriate setting.

QUICK DISCONNECT

Pull the power plug from the wall connector to disconnect the device quickly.

TRANSPORT CAP

In case of power failure or transport: Disconnect the quick connector and cap the mattress with the transport cap to slow deflation.

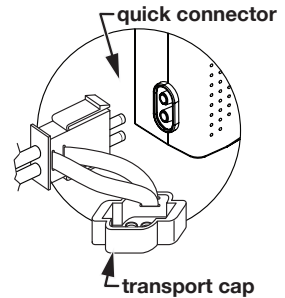

CPR FUNCTION

If CPR must be performed on the patient while the mattress is in use, to immediately deflate the mattress, either:

1. Pull the CPR valves from the mattress in the location of the arrow shown at right, or
2. Disconnect the quick connector from the pump in the location of the arrow shown at right.

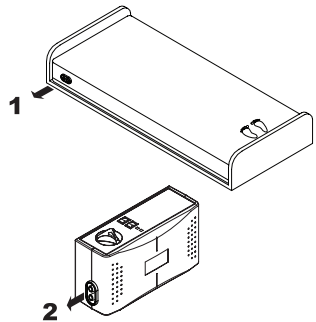

MAINTENANCE

CLEANING

Perform the following cleaning procedures before use.

Pump: Wipe the pump with a clean, damp cloth and mild detergent, and keep it away from dust. Air dry.

▲ **NOTICE: Do not use phenolic products or corrosive or powdered cleansers to clean the pump.**

▲ **NOTICE: Do not immerse or soak the pump.**

Mattress: Wipe the mattress unit with a clean, damp cloth and mild detergent. The mattress may also be cleaned using a 10% solution of sodium hypochlorite (bleach) diluted in water. Air dry all parts thoroughly before use.

▲ **NOTICE: Do not use phenolic products to clean the mattress.**

▲ **NOTICE: After cleaning, air dry the mattress without direct exposure to sunlight.**

GENERAL MAINTENANCE

1. Check main power cord and plug for abrasion or excessive wear.
2. Check mattress cover for signs of wear or damage. Ensure mattress cover and tubes are connected correctly.
3. Check airflow from the air hose connector. The airflow should alternate between each connector every half-cycle time if it's in alternating mode.
4. Check the air hoses for any kink or break. For replacement, please contact your GF equipment provider.

Fuse replacement

tool needed: small screwdriver

1. If you suspect a blown fuse, disconnect the plug from the wall outlet immediately.
2. Use a small screwdriver to remove the cover of the fuse holder (fuse locations are shown in picture at right).
3. Insert a new fuse of the correct rating (T1A/250V, VDE approved).
4. Replace the fuse holder cover.

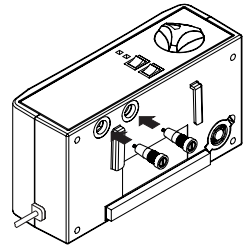

Air filter replacement

1. Remove the air filter plate located at rear of pump (filter location shown in picture at right).
2. Remove the filter. The filter is reusable, if not torn, and can be washed gently with a mild detergent and water. Dry the filter before use.
3. Replace the air filter regularly if it is gray, torn, or the environment is dirty.

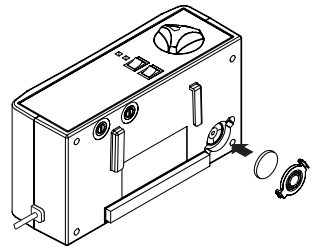

STORAGE

1. Lay the mattress out flat and upside down.
2. Roll from the head end toward the foot end.
3. Stretch the foot-end strap around the rolled mattress to prevent unrolling.
4. Store mattress and pump in a dust-free environment with no exposure to direct sunlight.

▲ NOTICE: Do not fold, crease or stack the mattress.

SPECIFICATIONS

| Pump | | Specification |
|-------------------------------|--------------------|---|
| Power Supply | | 120V System: AC 120V 60 Hz Info: see rating label on product |
| Fuse Rating | | T1A, 250V |
| Cycle time | | 8 minutes |
| Air input | | >4 LPM |
| Dimensions (L x W x H) | | 9.8" x 5.3" x 3.7" (25 x 13.5 x 9.5 cm) |
| Weight | | 4 lb (1.8 kg) |
| Environment | Temperature | Operation: 50°F to 104°F (10°C to 40°C) Storage: 5°F to 122°F (-15°C to 50°C) Shipping: 5°F to 158°F (-15°C to 70°C) |
| | Humidity | Operation: 10% to 90% non-condensing Storage: 10% to 90% non-condensing Shipping: 10% to 90% non-condensing |
| Classification | | Class II, Type BF, IPX0 Applied Part: Air Mattress Not suitable for use in the presence of a flammable anesthetic mixture (No AP or APG protection) |

| Mattress | | Specification |
|-------------------------------|--------------|---|
| Model | | 8" mattress |
| Dimensions (L x W x H) | | 78.7" x 35.4" x 8" (200 x 90 x 20.3 cm) |
| Weight | | 22.1 lb (10.0 kg) |
| Arrangement | | 20 x 8" bladders |
| Material | Cover | Nylon/PU |
| | Cells | Nylon/PU |
| | Base | PVC Tarpaulin |

WARRANTY

GF Health Products, Inc. warrants the Lumex AltaDyne 750000 Alternating Pressure / Low Air Loss Mattress System for a period of twelve months for defects in workmanship and materials. If a product is deemed to be under warranty, GF Health Products, Inc. shall provide, at its option, (1) replacement of any defective part or product or (2) a credit of the original selling price made to GF Health Products, Inc.'s initial customer. The warranty does not include any labor charges incurred in replacement part(s) installation or any associated freight or shipping charges to GF Health Products, Inc.

The warranties contained herein contain all the representations and warranties with respect to the subject matter of this document, and supersede all prior negotiations, agreements and understandings with respect thereto. The recipient of this document hereby acknowledges and represents that it has not relied on any representation, assertion, guarantee, warranty, collateral contract or other assurance, except those set out in this document.

**USA Corporate Headquarters:
GF Health Products, Inc.
2935 Northeast Parkway
Atlanta, Georgia 30360**

**telephone: 770-368-4700
fax: 770-368-2386**



GRAHAM-FIELD
www.grahamfield.com

© 2011, GF Health Products, Inc.

Free Manuals Download Website

<http://myh66.com>

<http://usermanuals.us>

<http://www.somanuals.com>

<http://www.4manuals.cc>

<http://www.manual-lib.com>

<http://www.404manual.com>

<http://www.luxmanual.com>

<http://aubethermostatmanual.com>

Golf course search by state

<http://golfingnear.com>

Email search by domain

<http://emailbydomain.com>

Auto manuals search

<http://auto.somanuals.com>

TV manuals search

<http://tv.somanuals.com>