

LUMEX[®]
A Graham-Field Brand

LF1031 HYDRAULIC PATIENT LIFT

LF1041 BATTERY POWERED PATIENT LIFT



USER MANUAL

LF1031-INS-LAB-RevD12
© 2012 GF Health Products, Inc.

Read this manual before operating your Patient Lift.

Save this manual for future use.

The most current version of this manual can be found online at
www.grahamfield.com

CONTENTS

1	INTRODUCTION.....	3
2	SAFETY PRECAUTIONS.....	4
	WARNINGS.....	4
3	FEATURES.....	6
4	HANDLING PROCEDURES.....	7
	SHIPPING AND TRANSPORTATION INSTRUCTIONS.....	7
5	ASSEMBLY INSTRUCTIONS.....	8
	COMPONENTS.....	8
	ASSEMBLY.....	9
6	OPERATING INSTRUCTIONS.....	14
	LF1041 ONLY: EMERGENCY PROCEDURES.....	14
	LIFT OPERATION: PATIENT TRANSFER.....	15
7	CARE AND MAINTENANCE.....	18
	BEFORE EACH USE.....	18
	BATTERY.....	18
	LUBRICATION.....	18
	CLEANING.....	19
	CHECKING FOR DAMAGE AND WEAR.....	19
	CARE OF SLINGS.....	19
	LF1031 ONLY: INSTALLATION OF 1010S005 HYDRAULIC PUMP.....	20
	MAINTENANCE SCHEDULE.....	22
8	TROUBLESHOOTING.....	23
9	SPECIFICATIONS.....	24
10	LIMITED WARRANTY.....	25
11	INDEX.....	27

GF Health Products, Inc. is not responsible for typographical errors.

For the most updated and current information on packaging, warranties, products and specifications, including the most current version of this manual, please visit our website at www.grahamfield.com.

Graham-Field and **Lumex** are registered trademarks of GF Health Products, Inc.

1 INTRODUCTION

Congratulations on your purchase of a Lumex patient lift. The following pages will provide you with important safety and operating instructions on the use of patient lifts, slings, and accessories, as well as maintenance and warranty information. Read this manual carefully before operating your patient lift and refer to it as often as needed. Consult your Lumex dealer and/or healthcare professional with any questions or concerns regarding safe and effective techniques for operating your patient lift.

The Lumex Patient Lift is intended to aid in the transfer of an individual who is unable to independently transfer between bed, chair, wheelchair, and/or commode.

DO NOT attempt any transfer without prior approval of the patient's healthcare provider. With their assistance, select the sling that best serves the needs, abilities, comfort and safety of the person being lifted. It is important that you use correct slings adapted to the body shape and weight and ability of the patient and the specific type of transfer needed.

Upon receipt of the patient lift, and prior to each use, inspect it closely to ensure that nothing is damaged, there are no loose or broken parts, that all patient lift parts are in the proper place, etc. Immediately replace any worn or broken components. Your patient lift should receive maintenance on a regular schedule and should be inspected daily for proper operation. Contact your Lumex dealer for service and repairs.

Before lifting anyone, thoroughly read the instructions in this manual. The operator should practice the entire lifting procedure several times with proper supervision and with a capable individual acting as patient. It is extremely important to know how a patient will feel in the patient lift. We suggest that the operator try all the various lifting slings and equipment until the operator is confident with how the patient lift operates. The lifting procedures should be explained to the patient before the actual lifting. Remember that safety requires the constant attention of the lift occupant and the operator. Use extreme care and common sense when operating a patient lift.

This guide covers the use of the LF1031 Hydraulic Patient Lift and the LF1041 Battery Powered Patient Lift. Keep in mind that the basic safety procedures included in this manual are to be used as a guide only. You may find it necessary to develop your own unique methods for safely utilizing the patient lift. Again, consult your healthcare professionals for their recommendations and never hesitate to ask for their assistance.

Info: Before attempting to assemble the patient lift, refer to ASSEMBLY INSTRUCTIONS on page 8. Contact your Lumex dealer if additional assistance is needed.

Info: In this manual, the person being lifted is referred to as the "patient" or "occupant" and the person operating the patient lift is called the "operator" or "attendant".

Please note the following special statements, used throughout this manual, and their significance:

- ⚠ WARNING: Indicates a potential hazard situation or unsafe practice that, if not avoided, could result in death or serious personal injury.**
- ⚠ CAUTION: Indicates a potential hazard situation or unsafe practice that, if not avoided, could result in minor or moderate personal injury.**
- ▲ NOTICE: Indicates a potential hazard situation or unsafe practice that, if not avoided, could result in product or property damage.**

Info: Provides application recommendations or other useful information to ensure that you get the most from your product.

2 SAFETY PRECAUTIONS

IMPORTANT: Before using patient lift, please read and adhere to the following safety precautions and warnings. Failure to do so could result in serious personal injury or damage to your patient lift.

Always consult your healthcare professional to determine safe methods most suitable for your individual abilities. Protect yourself, your attendant and patient lift by having it serviced regularly. If you experience any malfunction, contact your Lumex dealer immediately, as a hazardous condition could result, causing personal injury or damage to your patient lift.

Periodic inspection, adjustment and replacement of worn parts are necessary to provide years of excellent service. Refer to *CARE AND MAINTENANCE* section of this manual.

WARNINGS

- ⚠ WARNING: Important! Read and understand these instructions before assembling or using the LF1031 and LF1041. If you do not understand any part of these warnings, cautions or instructions, contact a healthcare professional for direction in the use of this product. If the Lumex Patient Lift is not properly assembled, personal injury and damage to the Lumex Patient Lift could result.**
- ⚠ WARNING: If components are damaged or missing, contact your dealer immediately. DO NOT use substitute parts. Use only Lumex replacement parts. The use of non-Lumex replacement parts could cause personal injury, property damage, and void the warranty.**
- ⚠ WARNING: The LF1031 Hydraulic Patient Lift / LF1041 Battery Powered Patient Lift maximum weight capacity is 400 pounds (181 kg), EVENLY DISTRIBUTED. DO NOT exceed the maximum weight capacity.**
- ⚠ WARNING: GF Health Products, Inc. assumes no responsibility for any damage or personal injury caused by improper assembly or use of this product.**
- ⚠ WARNING: Check all parts for shipping damage before using. In case of damage, DO NOT USE the equipment. Contact the carrier or your authorized Lumex dealer for further instructions.**
- ⚠ WARNING: Patient lift may tip over if used incorrectly. Read and adhere to the operating instructions prior to lifting anyone.**
- ⚠ WARNING: GF Health Products, Inc. strongly recommends that two caregivers take part in the lifting process.**
- ⚠ WARNING: When transferring a patient, always keep the patient centered over the base.**
- ⚠ WARNING: This patient lift is designed for transfer only. It is not intended to be used for transporting or moving a patient from one location to another.**
- ⚠ WARNING: Never use the patient lift to lift or transfer anything other than a person.**
- ⚠ WARNING: Ensure that lifting sling loops are correctly attached to the hooks to prevent the patient from sliding or falling out of the sling, which could result in personal injury. Ensure that sling grip handles are always positioned away from the patient so that the smooth side is facing the patient.**
- ⚠ WARNING: Do not lock or block the casters when lifting. The casters must be free to roll so that the patient lift can stabilize as the patient is initially lifted from a chair, bed, or any stationary object.**
- ⚠ WARNING: To ensure stability while lifting or transferring a patient, the patient lift legs must be locked in the maximum open position.**

- ⚠ WARNING: Replace any worn or broken parts immediately! Torn, cut, frayed, or broken slings can fail, resulting in personal injury. Use only slings that are in good condition.**
- ⚠ WARNING: Unauthorized modification of your patient lift or the use of non-Lumex replacement parts may change the structure of the lift and could create a hazardous condition, which may result in serious personal injury and will void the warranty.**
- ⚠ WARNING: LF1031 Hydraulic Patient Lift only: The hydraulic pump is sealed at the factory. If service is required, the unit must be returned to the factory for repair. DO NOT attempt to open the hydraulic pump or obtain local service; this will void the warranty and may result in damage to the unit. Consult your Lumex Dealer for further information.**
- ⚠ WARNING: LF1041 Battery Powered Patient Lift only: The electronics and actuator / motor contain no serviceable components. If service is required, the unit must be returned to the factory for repair. DO NOT attempt to open the electronics or actuator / motor or obtain local service; this will void the warranty and may result in damage to the unit. Consult your Lumex Dealer for further information.**
- ⚠ WARNING: Use extreme care, caution, and common sense when utilizing a patient lift. Special attention must be given to patients who are disoriented and cannot cooperate while being lifted, such as comatose, agitated, spastic, or mentally confused persons. Consult their healthcare professional for assistance in lifting these types of patients.**
- ⚠ WARNING: Lumex specifically disclaims responsibility for any bodily injury or property damage which may occur during any use which does not comply with federal, state or local laws or ordinances.**

3 FEATURES

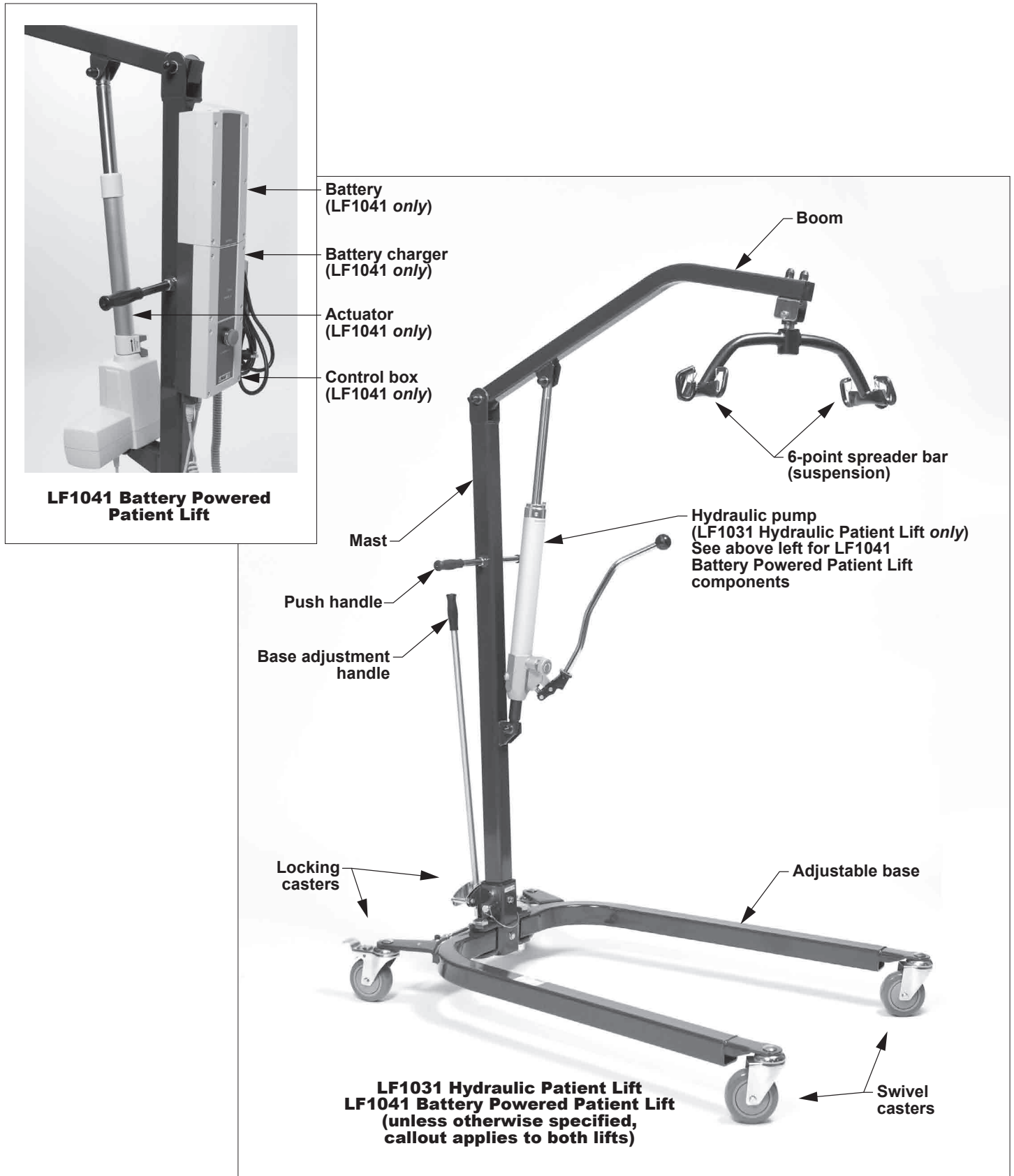

4 HANDLING PROCEDURES

SHIPPING AND TRANSPORTATION INSTRUCTIONS

If the patient lift is to be reshipped by common carrier, it should be packed in the same carton/s in which it was received (the LF1031 is shipped in one carton; the LF1041 motor may be packaged separately from the frame).

Unpacking

1. Check for any obvious damage to the carton or its contents. If damage is evident, notify the carrier or your authorized Lumex Dealer.
2. Remove all loose packing from the carton.
3. Carefully remove all the components from the carton.

Info: Unless the patient lift is to be used immediately, retain boxes, containers and packing material for use in storing until use of patient lift is required.

Inspection

1. Examine the exterior of the patient lift for nicks, dents, scratches or other damage.
2. Inspect all components.

Storage

1. Store the repackaged patient lift in a dry area.
2. DO NOT place other objects on top of the repackaged patient lift.

5 ASSEMBLY INSTRUCTIONS

The LF1031 patient lift is packed in one carton. The LF1041 motor may be in a separate carton. Components are shown in illustration below and called out in list below illustration.

COMPONENTS

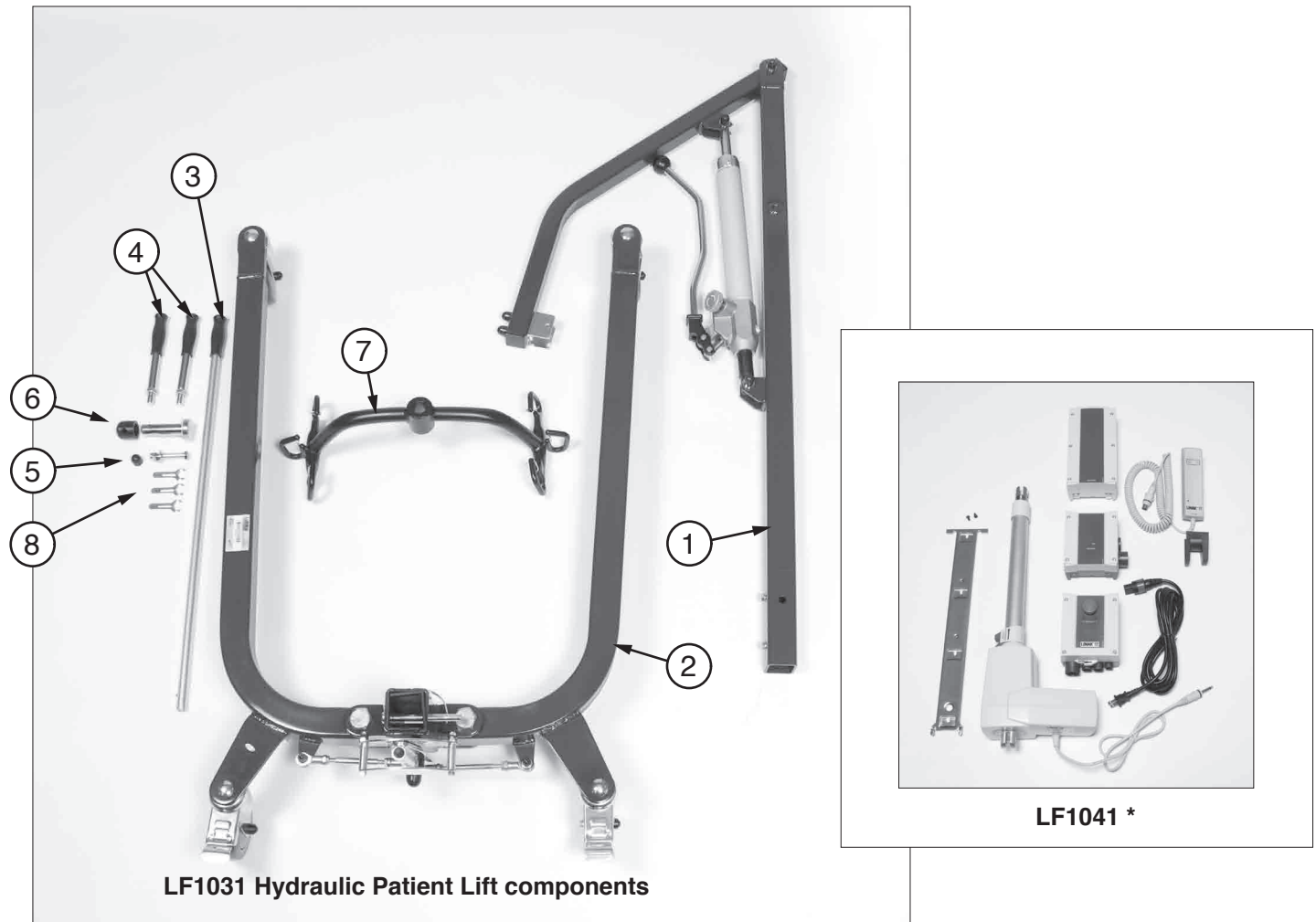

Item	Qty	Description
1	1	Mast/Boom/Pump assembly (LF1031)
	1	Mast/Boom assembly (LF1041) * Info: Actuator / Motor, Battery, Battery Charger, Control Box, Hand Control Pendant, Power Cable, and mounting items are packaged separately on LF1041.
2	1	Base
3	1	Base adjustment handle
4	2	Push handle
5	1	Spreader bar to boom attachment bolt
6	1	Spreader bar to boom attachment rod
7	1	Spreader bar
8	1	Assembly wrench set

ASSEMBLY

Base and mast assembly

1. Remove the locking pin from the mast sleeve located on the rear of the base.

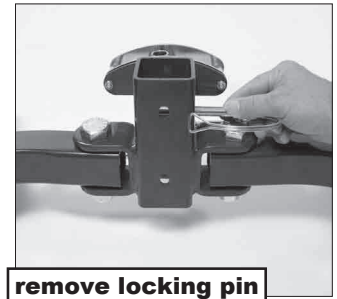

2. Install the L-inserts in the base.



3. With the boom pointed in the same direction as the base legs, insert the mast into the sleeve.
4. Insert the locking pin through the holes of the sleeve and mast.

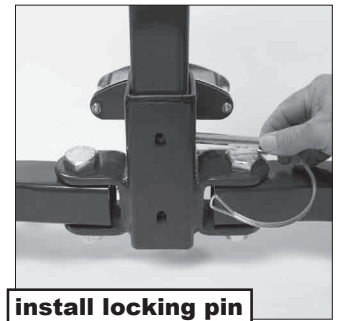

5. Secure the locking pin by attaching the locking cable to the other end of the locking pin.



6. Screw the two mast attachment bolts into the holes in the sleeve of the base.
7. Use the supplied hex wrench to tighten the bolts.

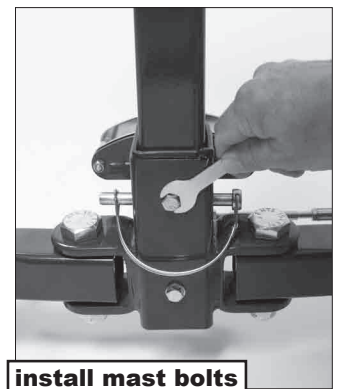

8. Screw the push handles into the mast and tighten them.



9. Insert spreader bar attachment rod into spreader bar. Insert spreader bar rod into the U-bracket at the end of the boom. Align holes. Insert spreader bar attachment bolt and tighten.

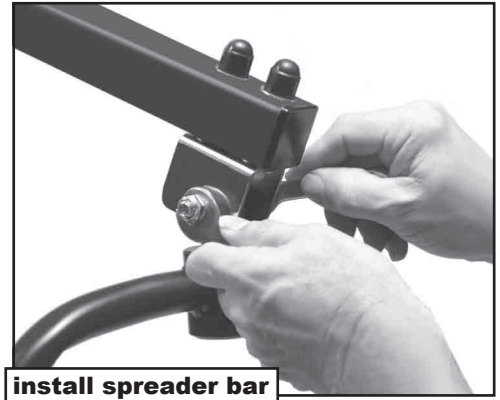

10. Install the base adjustment handle in the socket located behind the mast sleeve on the base. With base handle to the far right position, insert and tighten base attachment bolt to ensure that the handle is firmly attached to the base.

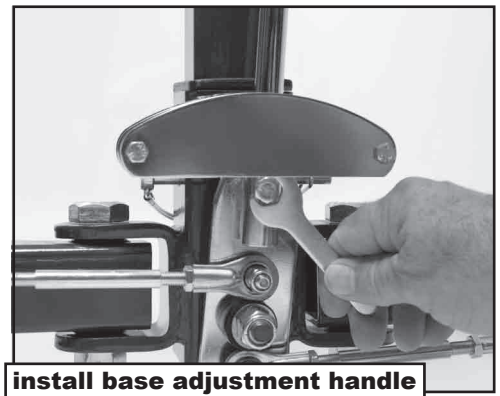

11. **LF1031 only:** For shipping purposes, the boom is in its lowest position. To elevate, turn the pump knob clockwise until hand tight and operate the pump handle.

The LF1031 lift is now ready for use.

LF1041 lift: continue to next page.

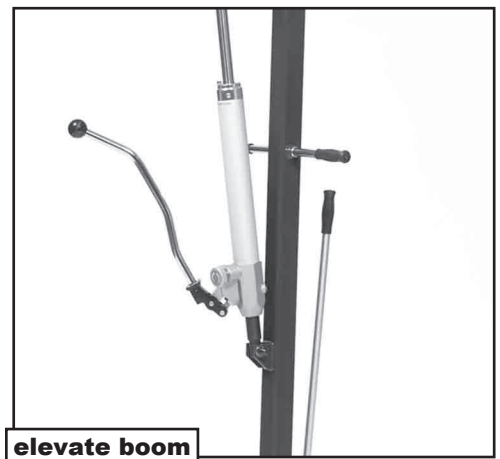

LF1041 only: attaching actuator / motor, power bracket, components

Tools needed: Phillips screwdriver, M3 hex key

1. Attach actuator / motor to boom and mast using the pre-attached bolts as shown at near right; note that illustration shows mounting points after assembly; shown components will not yet be present.
2. Use Phillips screwdriver to remove the three Phillips heads screws on the back of the mast. Position power bracket on mast as shown at upper far right. Secure power bracket to mast by installing the Phillips head mast screws as shown at upper far right (top screw is shown). Use Phillips screwdriver to tighten.
3. Mount control box on mast by sliding its lower end onto power bracket lip, as shown at near right. Secure control box by installing socket head cap screw at top of control box, as shown at far right. Use M3 hex key to tighten.
4. Mount battery charger on mast by sliding it onto power bracket lip so it rests on top of control box. Secure battery charger by installing socket head cap screw at top of battery charger, as shown at right. Use M3 hex key to tighten.
5. Mount battery to mast by sliding it onto top power bracket lip so it rests on top of battery charger, and boss on battery back fits into power bracket hole.
6. The control box, battery charger, and battery are shown correctly mounted on the mast at right.
7. Continue to next page for electrical power connections.

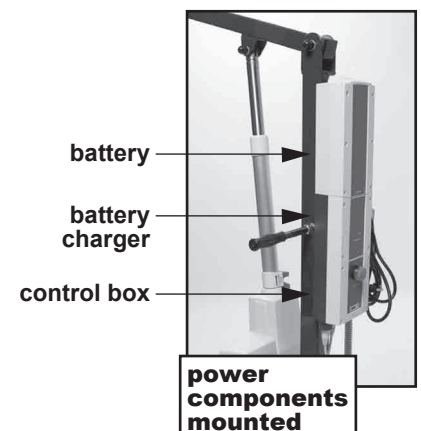
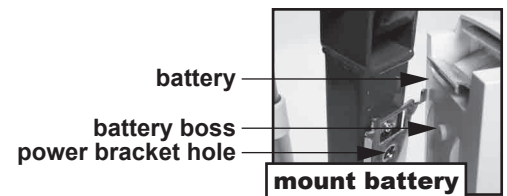
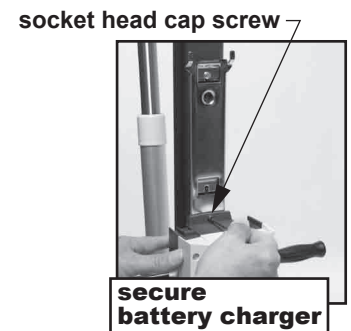
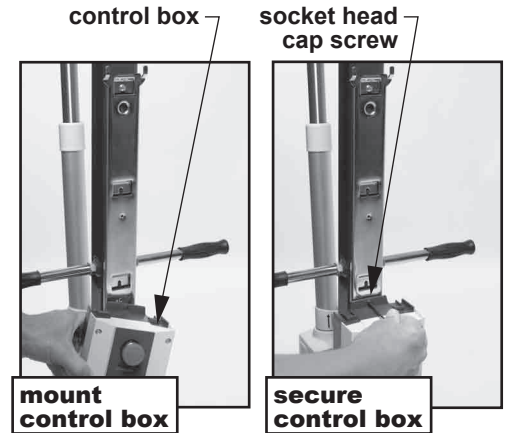
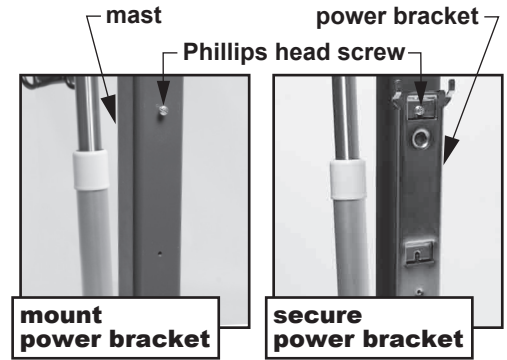
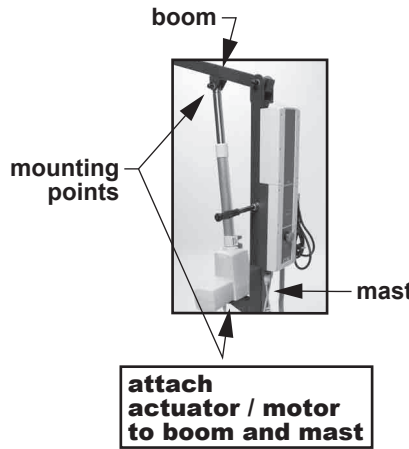

LF1041 only: electrical power connections

The control box is the heart of the electrical system.

The battery charger and battery are plugged into the control box via built-in stacking connectors, depending on battery charger options.

The hand control pendant and actuator / motor are plugged into the control box via the lower control box connectors, shown at right.

When standing behind the patient lift, the hand control pendant connection is on the far left of the control box.

1. Ensure the marks on the control box and the hand control pendant plug are aligned, then firmly insert the hand control pendant plug as shown at top right.
2. Immediately to the right of the hand control pendant connection is the actuator / motor connection. Insert the actuator / motor plug firmly in its receptacle (this plug has nothing to align).
3. Plug the power cord into its connector on the battery charger as shown at right.
4. Slide the power cord hook onto the battery charger as shown at right.
5. Snap the power cord hook onto the battery charger as shown at right.
6. Coil the power cord on the cord hook as shown at right.
7. Before proceeding, ensure that all plugs are seated firmly in the proper receptacles.

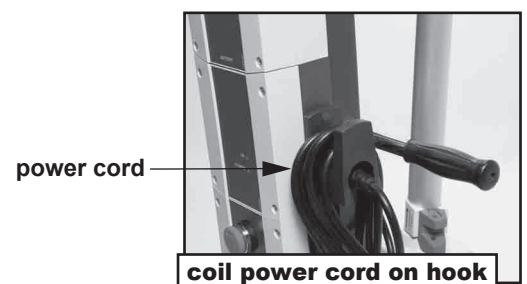
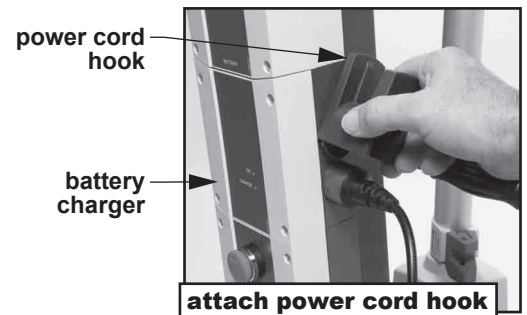
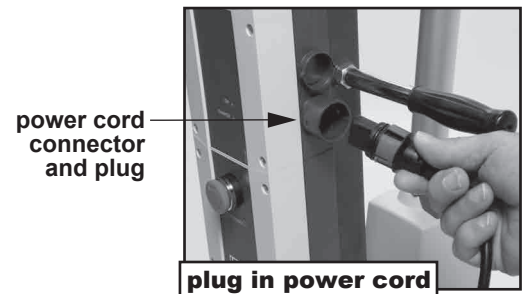
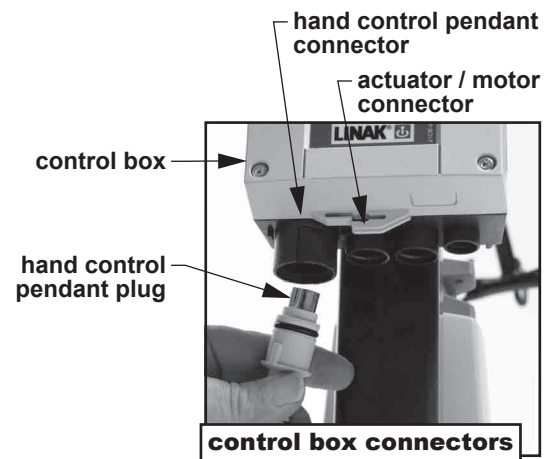

LF1041 only: charging the battery

The battery used on the LF1041 has an audible alarm that sounds when the battery charge has been depleted by 50%. Charge the battery as soon as possible upon hearing this alarm.

There is also a light on the hand control pendant that illuminates when it is time to recharge the battery.

Info: *This patient lift uses a lead acid battery. To prolong the life of the battery, charge the battery fully for 24 hours before initial use. To increase the longevity of the battery, keep the battery fully charged when not in use. Subsequent battery charging time is approximately four hours.*

⚠ WARNING: After the alarm sounds, there could still be sufficient battery power left to lift a patient. Be aware that a lifted patient cannot be lowered when the battery is discharged. Refer to the Emergency Procedures section that follows for discharged battery operation.

Charging the battery with lift-mounted battery charger: With control box, battery charger, and battery assembled, insert the power cord plug into a standard 110V receptacle. A green light signifying power and a yellow light signifying that the battery is charging will illuminate on the battery charger. When the battery is fully charged, the yellow light will shut off. Unplug the power cord from the receptacle and replace it on the power cord hook.

Info: *The patient lift will not operate during lift-mounted battery charging.*

The LF1041 lift is now ready for use.

Charging the battery with wall-mounted battery charger: Remove the battery from its bracket on the patient lift by placing your hand on top of the battery, curling your fingers behind the battery, and pulling up on the metal handle. Pull the battery up and toward you to remove. Place the battery on top of the wall-mounted battery charger. A green light signifying power and a yellow light signifying that the battery is charging will illuminate on the battery charger. When the battery is fully charged, the yellow light will shut off. When battery charging is complete, place the battery back on the patient lift. Ensure the battery tabs are fully engaged with the bracket.

The LF1041 lift is now ready for use.

LF1041 only: control box power switch (emergency stop button)

In order to use the lift, the **control box power switch** must be turned ON. To turn the control box power switch ON, turn the red switch button clockwise, it will pop out to the ON position.

To turn the control box power switch OFF, hit it firmly with the palm of your hand; the switch will lock in the depressed position, stopping all motor function.

To prolong the life of the battery, turn the control box power switch OFF when the lift is not in use.

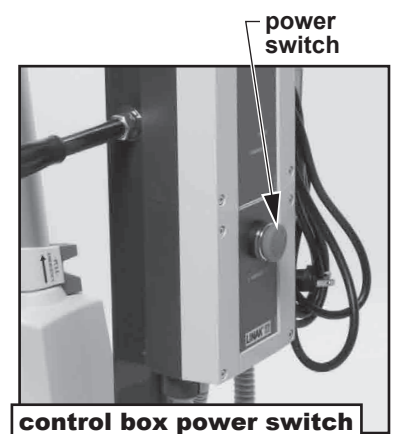

6 OPERATING INSTRUCTIONS

LF1041 ONLY: EMERGENCY PROCEDURES

Emergency stop: The control box is equipped with a red **emergency stop button**. This button, also known as the control box power switch, is to be used in the event the hand control pendant ceases to function correctly. To engage, hit the button firmly with the palm of your hand. The button will lock in the depressed position, stopping all motor function. To disengage, turn the button clockwise; it will pop out and return to the ON position.

Emergency lowering: The motor is equipped with an **emergency release**, which is located on top of the motor as shown in the picture at right. To engage, pull up on the release, which will disengage the gearing in the cylinder, and lower the patient. The emergency release is adjustable by turning the screw adjacent to the pull stem. Turn the screw clockwise to increase and counter-clockwise to decrease the sensitivity of the release mechanism.

⚠ WARNING: Use caution when using the emergency release. Pull back slowly on the release, which will gradually lower the patient. Pulling back too quickly could cause the patient to be lowered too rapidly, which could result in serious personal injury. Do not, under any circumstances, use the emergency release for lowering the patient when the hand control pendant and battery are operating correctly. The emergency release should not be used in lieu of the hand control pendant and battery.

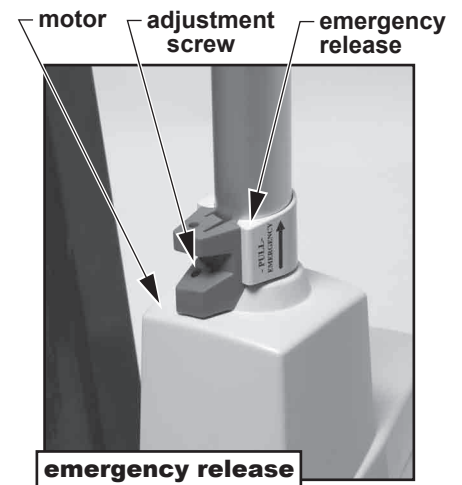

LIFT OPERATION: PATIENT TRANSFER

- ⚠ **WARNING: Do not attempt to transfer a patient without prior approval of the patient's healthcare professional and without having read the instructions and practiced using the patient lift.**
- ⚠ **WARNING: Use special care for those patients who cannot cooperate while being lifted.**
- ⚠ **WARNING: Ensure all bolts, hooks, and loops are securely fastened.**
- ⚠ **WARNING: Use only Lumex slings with Lumex patient lifts. DO NOT exceed the maximum weight capacity of the selected sling.**
- ⚠ **WARNING: DO NOT use torn, cut, frayed or broken slings as personal injury could result.**
- ⚠ **WARNING: Ensure the floor area is clear of any obstacle that could cause a caster to stop and possibly tip the patient lift.**
- ⚠ **WARNING: GF Health Products, Inc. strongly recommends that two caregivers take part in the lifting process.**

Info: Instructional videos that review the application of several sling styles and lifting scenarios are available at www.grahamfield.com.

Lifting the patient from a bed

1. With patient face-up in center of bed, roll patient onto their side away from attendant.
 2. Place sling, folded lengthwise, halfway under patient with lower edge just beneath knees.
 3. Roll patient onto their side toward attendant, pull sling to smooth it, and center patient on sling.
 4. Pull the leg loops forward and under the thighs.
 5. Cross the loops, one through the other.
 6. Roll the base of the patient lift under the bed, locating the spreader bar over the patient. Be careful not to lower the spreader bar onto the patient. Center the spreader bar over the patient before lifting.
- ⚠ **WARNING: Do not lock or block the patient lift casters when lifting. The casters must be free to roll so that the patient lift can stabilize as the patient is lifted from the bed.**
 - ⚠ **WARNING: To ensure stability while lifting or transferring a patient, the patient lift legs must be locked in the maximum open position.**
7. Hook the sling loops onto the spreader bar.
 8. If the patient is in a hospital bed, raise the bed's head section to elevate the patient.
 9. Raise the patient carefully. If possible, lower the bed. Reposition the patient as needed, using the handle on the back of the sling, to ensure a safe and comfortable sitting position as the patient is raised.
 10. Raise the patient until the buttocks are just above the mattress. Lift the patient's legs and turn the patient to face the lifting column. Move the patient lift away from the bed. Ensure that the patient's arms and legs clear the patient lift, bed, or any other obstacles.

Lowering the patient onto a bed

1. Raise the patient lift until the patient's buttocks are above the surface of the bed. Ensure that there are no obstacles underneath or around the bed. Move the patient lift under the bed. Ensure the patient does not hit any portion of the bed and that the patient's legs have cleared the bed.

2. Center the patient over the bed, and rotate the patient to face the foot section of the bed. SLOWLY release the pressure knob by turning it counter-clockwise for gradual lowering of the patient (LF1031) or using the hand control pendant (LF1041). Carefully lower the patient onto the bed. Support the patient's head, if necessary, while being lowered. Remove the sling by reversing the procedures used when lifting patient from bed.

Lifting the patient from the floor

1. Position the patient lift behind the patient, placing a pillow over the base to protect and support the patient's head and neck. Place the patient's head carefully on the base. The patient lift should be positioned with the spreader bar centered over the patient.
2. Lower the spreader bar. Attach the sling to the spreader bar hooks.
3. Lift the patient up above the floor. Position the patient in the sling by pulling the handle on the back of the sling. Turn the patient to face the lifting column, and place the patient's feet on the base, straddling the column for extra stability.

Lowering the patient to the floor

1. Place a pillow on the base to protect the patient's head and neck (this is unnecessary when using a sling with a head support).
2. Reverse the above procedures to lower.

Transferring the patient from a chair to a wheelchair or commode chair

Info: GF Health Products, Inc. recommends that two attendants be used when transferring a patient to and from a wheelchair.

1. Fold the sling.
2. While maintaining support, gently lean the patient forward. Place the folded sling behind the patient's back and push it down until it touches the seat of the chair.
3. Use the loops to pull the leg sections of the sling forward and beneath the patient's thighs. Then cross the loops, one through the other.
4. Move the patient lift around to the front of the chair.
5. Hook all sling loops onto the spreader bar.
6. Carefully raise the patient.
7. The second attendant should now move the wheelchair into position.
8. Engage the wheelchair wheel locks to prevent movement.

⚠ WARNING: Before transfer, ensure wheelchair wheel locks are in locked position. Wheelchair wheel locks must be in a LOCKED POSITION before lowering the patient into the wheelchair, or unexpected wheelchair movement could result, which may result in serious personal injury to both the patient and the attendants.

9. Position the patient over the wheelchair with their back against the back of the wheelchair.
10. SLOWLY lower the patient into the wheelchair.
11. With one attendant behind the wheelchair and the other operating the lift, the attendant behind the chair should pull back on the handle or sides of the sling to place the patient into the back of the chair. This will maintain a good center of balance and prevent the chair from tipping forward.

Removing the sling

Gently pull the leg sections to the side, out from under the patient's thighs. Standing by the patient's side, lean the patient forward while supporting the patient with one hand. Pull the sling up from behind the patient's back and position the patient in the chair.

⚠ WARNING: Pulling sharply on the sling may cause the patient to fall forward, resulting in personal injury. Always support the patient by keeping one arm around the patient's shoulders when placing or removing the sling.

Info: If possible, the patient should be encouraged to take an active part in removing the sling. The patient can lean forward, lift their thighs, and help in removing the leg sections.

Transferring the patient from a bed to a wheelchair or commode chair

1. For smooth, easy lifting, have the wheelchair or commode chair in ready position with wheel locks in locked position.
2. With patient face-up in center of bed, roll patient onto their side away from attendant.
3. Place sling, folded lengthwise, halfway under patient with lower edge just beneath knees.
4. Roll patient to side toward attendant, pull sling to smooth it, and center patient on sling.
5. Pull the leg loops forward and under the thighs.
6. Cross the loops, one through the other.
7. With base of lift under bed, SLOWLY release pressure knob by turning it counter-clockwise and pulling the boom down (LF1031) or using the hand control pendant (LF1041). Attach sling to spreader bar.
8. Turn pressure knob clockwise until tight, and lift the patient by operating the pump handle.
9. Lift patient, maintaining patient's position facing attendant, until patient's feet swing easily off the bed.
10. Position patient above wheelchair or commode chair. Lock lift brakes.

⚠ WARNING: Before transfer, ensure wheelchair or commode chair wheel locks are in locked position. Wheelchair wheel locks must be in a LOCKED POSITION before lowering the patient into the wheelchair, or unexpected wheelchair movement could result, which may result in serious personal injury to both the patient and the attendants.

11. SLOWLY release pressure knob by turning it counter-clockwise and pulling the boom down (LF1031) or using the hand control pendant (LF1041) to gradually lower patient. During descent, assist patient in attaining correct sitting posture.
12. When patient is seated, push down on boom to slacken sling loops. Patient can remain seated on sling.
13. For commode chair use, adjust clothing before moving lift to straddle commode chair. Keep sling loops taut and ensure that patient is in a comfortable position.

7 CARE AND MAINTENANCE

Proper care and maintenance are essential to keeping your Lumex patient lift in a safe operating condition. In addition to inspecting the unit before each use, periodic maintenance checks should be done. We further recommend that this unit be serviced at least once annually by an authorized dealer.

⚠ WARNING: It is extremely important that the patient lift be inspected before each use. Ensure that all hardware and accessories are secure and that the actuator / motor is functioning properly. Failure to do so could result in patient / attendant personal injury or damage to your patient lift. Torn, cut, frayed or broken slings can fail, resulting in serious personal injury. Only use slings in good condition. Inspect before each use. Destroy and discard old, worn and unusable slings.

When you believe a component or part is not functioning properly, immediately contact your authorized Lumex dealer, as a potentially hazardous condition could exist.

BEFORE EACH USE

Before each use of the patient lift, ensure that:

- All nuts and bolts are tight
- The lift moves freely (with caster brakes off)
- Rear caster brakes operate properly
- Base adjustment mechanism operates easily
- Spreader bar clips are secured tightly
- The hydraulic pump operates properly (LF1031 only)
The electronic components operate properly (LF1041 only)

BATTERY

To increase the longevity of the battery, plug in the charger whenever possible (LF1041 only).

LUBRICATION

Your Lumex patient lift was designed with minimum maintenance in mind; however, a six (6) month check and lubrication should ensure that your patient lift will remain in peak operating condition. The casters **MUST** roll and swivel freely. Lightweight waterproof grease (such as automobile lubricant) should be applied to the ball bearings of the casters every six (6) months. Apply grease more frequently if the casters are exposed to periods of excess moisture. Lubricate all pivot points with lightweight oil. Clean patient lift of all excess oil and grease.

Before use of the patient lift, and every two months thereafter, place a drop of oil on the following areas:

- The point where mast and boom connect
- Spreader bar hooks
- Pump handle hinge
- Caster axles
- The point where pump and boom connect (LF1031 only)
The point where actuator / motor and boom connect (LF1041 only)

CLEANING

Regular cleaning is recommended. A soft cloth, dampened with water and a mild NON-ABRASIVE detergent (household cleaner, soapy water, or hospital grade disinfectant) is all that is needed to clean your patient lift. Automobile wax or furniture polish will help maintain the finish over a long period of time.

▲ NOTICE: DO NOT wash under water pressure or steam clean.

CHECKING FOR DAMAGE AND WEAR

It is extremely important to frequently check the areas of the patient lift that are under a great deal of stress for damage and wear. These areas include slings, spreader bars, spreader bar suspension and mounting hardware, pump mounting hardware and all pivot points. Inspect for signs of cracking, fraying, deformation, and any loose components

⚠ WARNING: Replace any defective parts immediately, and make certain that the patient lift is not used until repairs are made. Contact your authorized Lumex dealer for replacement parts.

CARE OF SLINGS

Lumex slings are washable at 150° F and autoclavable at 185° F for 30 minutes. The head support's plastic insert should be removed before washing. The slings can be dried by using a dryer on LOW heat or by hanging.

▲ NOTICE: DO NOT bleach slings!

LF1031 ONLY: INSTALLATION OF 1010S005 HYDRAULIC PUMP

Removal of Existing Pump

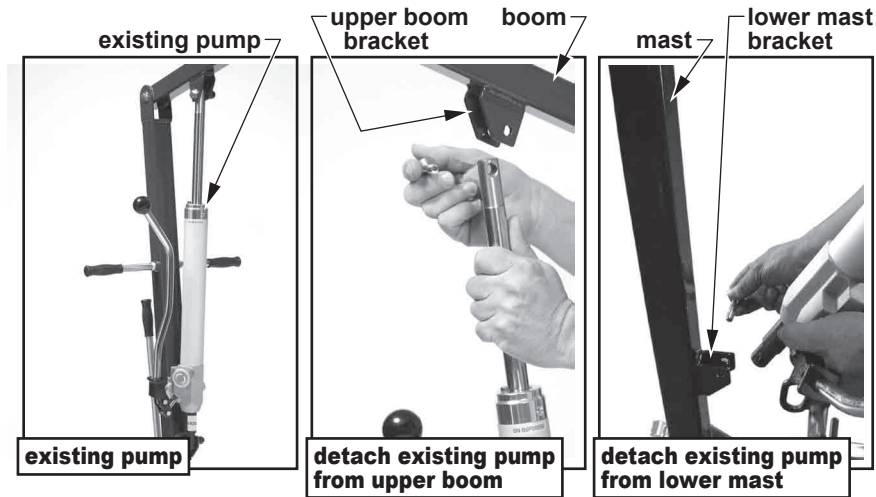

1. Follow the instructions in this section to remove the existing pump, shown at above left. If installing pump for the first time, proceed to **Installation of new pump** on next page.
2. Detach the top of the existing pump from the upper boom bracket, as shown at above center: Use two $\frac{9}{16}$ " wrenches to remove the hardware that secures top of pump to upper boom bracket. This will free the pump to rotate downward.
3. Detach the bottom of the existing pump from the lower mast bracket, as shown at above right. Use two $\frac{9}{16}$ " wrenches to remove the hardware that secures bottom of pump to lower mast bracket. This will free the pump — take care that it does not fall.

Installation of New Pump

Tools needed: two $\frac{9}{16}$ " wrenches

Info: The hardware to attach the Hydraulic Pump (GF #1010S005) to the LF1031 mast and boom comes with the lift frame.

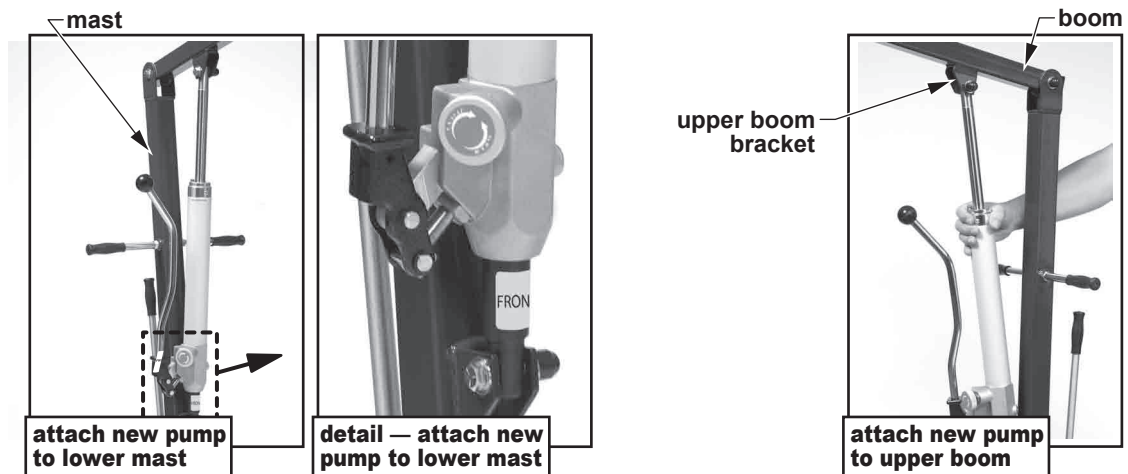

1. Attach the bottom of the new hydraulic pump to the lower mast bracket with the pressure knob and pump lever toward the bottom of the pump, as shown at above left, and the “**FRONT**” label toward you, as shown at above center. Use a hex bolt, washers, and hex nut to secure pump to mast. Use two $\frac{9}{16}$ ” wrenches to tighten.
2. Attach the top of the hydraulic pump to the upper boom bracket, as shown at above right. Use a hex bolt, washers, and hex nut to secure pump to boom. Use two $\frac{9}{16}$ ” wrenches to tighten.

⚠ WARNING: Ensure that the Hydraulic Pump is installed as described. If the Hydraulic Pump is not properly installed, personal injury and damage to the Hydraulic Pump could result.

MAINTENANCE SCHEDULE

Info: Only qualified persons should service and repair your Lumex patient lift. Regular maintenance of your patient lift is necessary to ensure continuing proper and safe operation. Read and observe the following recommended maintenance schedule:

Item	Inspect initially	Inspect/adjust		
		daily	monthly	every 6 months
Base and Casters				
Ensure that base is level (all four wheels touch the floor)	X		X	X
Ensure that caster mounting bolts and axle bolts are tight	X		X	
Ensure that casters swivel and roll freely	X		X	
Apply a light grease to caster ball bearings				X
Base Adjustments				
Ensure that base opens and closes smoothly	X		X	X
Ensure that base locks securely in three positions	X		X	
Ensure that locking knob is in place and operating properly	X		X	
Inspect all base hardware for wear			X	
Mast				
Ensure that mast is fully engaged and locked into mast sleeve	X		X	
Inspect mast for bends or deflections			X	
Inspect all mast hardware for wear			X	X
Boom				
Inspect boom for bends or deflections	X		X	
Ensure that boom is centered between the base legs	X		X	X
Inspect all boom hardware for wear			X	
Spreader Bar				
Inspect hanger post for wear or damage			X	
Inspect sling hook for wear or deflections			X	X
Inspect all spreader bar hardware for wear			X	X
Slings				
Inspect slings and straps for wear or damage		X		
Inspect metal/plastic parts for wear or damage		X		
Lubrication with light oil				
Lubricate all pivot points				X
Lubricate top and bottom of actuator / motor mounting				X
Cleaning				
Clean with mild non-abrasive detergent				X
Pump (LF1031 only)				
Ensure that pump mounting hardware is tight	X		X	
Inspect pump mounting hardware for wear			X	
Electronics and actuator / motor (LF1041 only)				
Ensure that battery is fully charged	X	X		
Inspect for proper up / down operation	X	X		
Ensure that mounting hardware is tight	X		X	
Inspect mounting hardware for wear			X	

8 TROUBLESHOOTING

⚠ WARNING: If you experience a problem with your lift and are unable to service it yourself, contact your Lumex dealer.

LF1031 HYDRAULIC PATIENT LIFT		
SYMPTOM	POSSIBLE CAUSE	ACTION
Patient lift does not go up or down	Air in the cylinder	Bleed the cylinder by turning the release knob and push down on the mast. Pump up the lift again and turn the release knob again.
	Loss of hydraulic fluid (leaking cylinder)	Replace any leaking cylinder
Patient lift does not go down	Air in the cylinder	See above Directions
<i>Info: If the hydraulic cylinder begins leaking fluid, do not operate lift. Contact your Lumex dealer for a new cylinder.</i>		

LF1041 BATTERY POWERED PATIENT LIFT		
SYMPTOM	POSSIBLE CAUSE	ACTION
Control box is not responding and relay is not clicking	Battery discharged	Charge battery
	Battery charger defective	Replace battery charger
	Battery defective	Replace battery
	Hand control pendant defective	Replace hand control pendant
Actuator / motor does not run, but relay is clicking	Actuator plug not properly seated	Push actuator plug firmly into control box
	Actuator defective	Replace actuator
	Control box defective	Replace control box
Actuator / motor goes up or down, but not both	Hand control pendant defective	Replace hand control pendant
	Control box defective	Replace control box

9 SPECIFICATIONS

Info: All dimensions are given in inches unless otherwise specified.

LF1031 HYDRAULIC PATIENT LIFT / LF1041 BATTERY POWERED PATIENT LIFT	
Base width	Open: 39.4"
	Closed: 25.6"
Base height clearance	5-1/2"
Base length	45.30"
Lifting height range Info: As measured from point where spreader bar attaches to boom.	Minimum: 27.4"
	Maximum: 77.7"
	Range: 50.3"
Mast height	55.1"
Weight capacity	400 lb (181 kg), EVENLY DISTRIBUTED
Caster size	4.00" diameter, both locking and non-locking
Product weight	90 lb
Shipping weight	103.2 lb

10 LIMITED WARRANTY

GF Health Products Inc. warrants this product to be free from manufacturing defects in material and workmanship for its period of warranty that is in accordance with industry standards. This warranty is extended only to the original purchaser/consumer or dealer/non-consumer of this new product and to no other purchaser or transferee.

GF Health Products, Inc. warrants the Lumex® LF1031 Hydraulic Patient Lift and its components to be free from defects in workmanship and materials as listed below:

Frame / Parts: 1 Year
Hydraulic Pump: 1 Year

GF Health Products, Inc. warrants the Lumex® LF1041 Battery Powered Patient Lift and its components to be free from defects in workmanship and materials as listed below:

Frame / Parts: 1 Year
Electronics: 1 Year
Actuator / motor: 1 Year

The Warranty period for the consumer commences on the first date a product is delivered to consumer by seller/dealer. If the product is rented or leased, the warranty period commences on the invoice date from *GF Health Products, Inc.* A copy of the invoice showing date of purchase must be provided when submitting warranty claims. When proof of purchase date is not provided, warranty coverage shall commence upon *GF Health Products, Inc.*'s invoice date to the dealer/purchaser.

If within the warranty period, the product or component part is proven to *GF Health Products, Inc.*'s satisfaction to be defective, *GF Health Products, Inc.* shall provide, at its option, one of the following: (1) repair or replacement of any defective or nonconforming part or product or (2) a credit and/or refund of the original selling price. GF HEALTH PRODUCTS, INC.'S SOLE OBLIGATION AND YOUR EXCLUSIVE REMEDY UNDER THIS WARRANTY SHALL BE LIMITED TO SUCH REPAIR, REPLACEMENT, CREDIT AND/OR REFUND. This warranty does not include any labor charges incurred in replacement part(s) installation or any associated freight or shipping charges to the manufacturer.

For warranty service, please contact the authorized distributor from whom you acquired your *GF Health Products, Inc.* product. Upon receiving notice of an alleged defect in a product, *GF Health Products, Inc.* will issue a return authorization. The defective product or part(s) must then be returned, at the purchaser's cost, for warranty inspection using the serial number as identification (or, if the product is not serialized, lot number and date code) within thirty (30) days of return authorization issue date. In the event you do not receive satisfactory warranty service, please contact *GF Health Products, Inc.* at the address below. DO NOT return products to our factory without prior authorization.

LIMITATIONS AND EXCLUSIONS: The foregoing warranty excludes consumables, such as filters and tubing, as these require routine maintenance. The foregoing warranty shall not apply to serial numbered products if the serial number has been removed or defaced. Products subjected to negligence, abuse, misuse, improper operation, improper maintenance, improper cleaning, improper storage, or damages beyond *GF Health Products, Inc.*'s control are not covered by this warranty, and that evaluation shall be solely determined by *GF Health Products, Inc.* This warranty shall not apply to problems arising from normal wear and tear or failure to follow instructions. The warranty shall also not apply to products modified without *GF Health Products, Inc.*'s express written consent; nor shall it apply if parts not manufactured by *GF Health Products, Inc.*, or if parts not complying with original equipment specifications are added to *GF Health Products, Inc.* products, or if the product or part is serviced by an entity not authorized by *GF Health Products, Inc.*

THE FOREGOING WARRANTY IS EXCLUSIVE AND IN LIEU OF ALL OTHER EXPRESS WARRANTIES AND IMPLIED WARRANTIES, INCLUDING BUT NOT LIMITED TO THE IMPLIED WARRANTIES OF MERCHANTABILITY AND FITNESS FOR A PARTICULAR PURPOSE, AND SHALL NOT EXTEND BEYOND THE DURATION OF THE EXPRESS WARRANTY PROVIDED HEREIN, AND THE REMEDY FOR VIOLATIONS OF ANY IMPLIED WARRANTY SHALL BE LIMITED TO THE REPAIR, REPLACEMENT, CREDIT AND/OR REFUND OF THE DEFECTIVE PRODUCT OR PART PURSUANT TO THE TERMS CONTAINED HEREIN. GF HEALTH PRODUCTS, INC. SHALL NOT BE LIABLE FOR ANY CONSEQUENTIAL OR INCIDENTAL DAMAGES WHATSOEVER.

This warranty gives you specific legal rights and you may also have other legal rights which vary from state to state (province to province). Some states (provinces) do not allow the exclusion or limitation of incidental or consequential damage, or limitation on how long an implied warranty lasts, so the above exclusion and limitations may not apply to you.

The warranties contained herein contain all the representations and warranties with respect to the subject matter of this document, and supersede all prior negotiations, agreements and understandings with respect thereto. The recipient of this document hereby acknowledges and represents that it has not relied on any representation, assertion, guarantee, warranty, collateral contract or other assurance, except those set out in this document.

GF Health Products, Inc. (“Graham-Field”)
2935 Northeast Parkway
Atlanta, GA 30360
Tel 770-368-4700, Fax 770-368-2386

11 INDEX

A

Assembly instructions 8

B

Battery care 18

Before each use 18

C

Care and maintenance 18

Care of slings 19

CAUTION statement, significance 3

Checking for damage and wear 19

Cleaning 19

Components 8

F

Features 6

H

Handling Procedures 7

I

Info statement, significance 3

Inspection 7

Introduction 3

L

LF1031 only: hydraulic pump 1010S005, installation 20

LF1041 only: attaching power bracket and components
11

LF1041 only: charging the battery 13

LF1041 only: electrical connections 12

LF1041 only: emergency procedures 14

Lifting the patient from a bed 15

Lifting the patient from the floor 16

Lift operation: patient transfer 15

Lowering the patient onto a bed 15

Lowering the patient to the floor 16

Lubrication 18

M

Maintenance schedule 22

N

NOTICE statement, significance 3

O

Operating instructions 14

R

Removing the sling 17

S

Safety precautions 4

Safety statements, significance of 3

Shipping and transportation instructions 7

Specifications 24

Storage 7

T

Transferring the patient from a bed to a wheelchair or
commode chair 17

Transferring the patient from a chair to a wheelchair or
commode chair 16

Troubleshooting 23

U

Unpacking 7

V

Videos, instructional, at www.grahamfield.com 15

W

Warnings 4

WARNING statement, significance 3

Warranty, limited 25

Weight capacity 4

**GF Health Products, Inc.
2935 Northeast Parkway
Atlanta, Georgia 30360 USA**

tel: 770-368-4700



GRAHAM-FIELD

www.grahamfield.com

Made in Taiwan

Free Manuals Download Website

<http://myh66.com>

<http://usermanuals.us>

<http://www.somanuals.com>

<http://www.4manuals.cc>

<http://www.manual-lib.com>

<http://www.404manual.com>

<http://www.luxmanual.com>

<http://aubethermostatmanual.com>

Golf course search by state

<http://golfingnear.com>

Email search by domain

<http://emailbydomain.com>

Auto manuals search

<http://auto.somanuals.com>

TV manuals search

<http://tv.somanuals.com>