

Installation, Operation and Maintenance Manual

Please read and save these instructions. Read carefully before attempting to assemble, install, operate or maintain the product described. Protect yourself and others by observing all safety information. Failure to comply with instructions could result in personal injury and/or property damage! Retain instructions for future reference.

Model BCSW-FRP

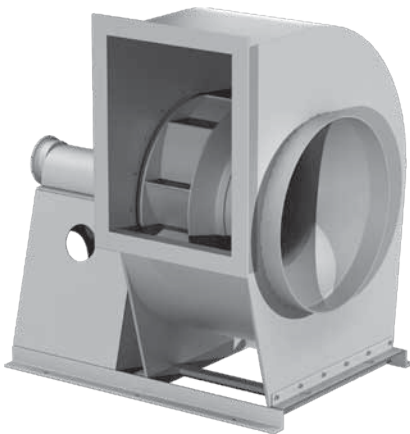

General Safety Information

Only qualified personnel should install this fan. Personnel should have a clear understanding of these instructions and should be aware of general safety precautions. Improper installation can result in electric shock, possible injury due to coming in contact with moving parts, as well as other potential hazards. Other considerations may be required if high winds or seismic activity are present. If more information is needed, contact a licensed professional engineer before moving forward.

DANGER

Always disconnect power before working on or near a fan. Lock and tag the disconnect switch or breaker to prevent accidental power up.

CAUTION

When servicing the fan, motor may be hot enough to cause pain or injury. Allow motor to cool before servicing.

CAUTION

Precaution should be taken in explosive atmospheres.

1. Follow all local electrical and safety codes, as well as the National Electrical Code (NEC), the National Fire Protection Agency (NFPA), where applicable. Follow the Canadian Electric Code (CEC) in Canada.
2. The rotation of the wheel is critical. It must be free to rotate without striking or rubbing any stationary objects.
3. Motor must be securely and adequately grounded.
4. Do not spin fan wheel faster than max cataloged fan rpm. Adjustments to fan speed significantly effects motor load. If the fan RPM is changed, the motor current should be checked to make sure it is not exceeding the motor nameplate amps.
5. Do not allow the power cable to kink or come in contact with oil, grease, hot surfaces or chemicals. Replace cord immediately if damaged.
6. Verify that the power source is compatible with the equipment.
7. Never open access doors to a duct while the fan is running.

Receiving

Upon receiving the product check to make sure all items are accounted for by referencing the bill of lading to ensure all items were received. Inspect each crate for shipping damage before accepting delivery. Notify the carrier if any damage is noticed. The carrier will make notification on the delivery receipt acknowledging any damage to the product. Impact damage will appear as whitening of the surface or star-shaped cracks or crazes. If this damage is limited to the exterior surface of the fan, it may be superficial. The fan should not be installed until fully repaired by an authorized repairman. All damage should be noted on all the copies of the bill of lading which is countersigned by the delivering carrier. A Carrier Inspection Report should be filled out by the carrier upon arrival and the Traffic Department. If damaged upon arrival, file claim with carrier. Any physical damage to the unit after acceptance is not the responsibility of Greenheck Fan Corporation.

Unpacking

Verify that all required parts and the correct quantity of each item have been received. If any items are missing, report shortages to your local representative to arrange for obtaining missing parts. Sometimes it is not possible that all items for the unit be shipped together due to availability of transportation and truck space. Confirmation of shipment(s) must be limited to only items on the bill of lading.

Handling

The fan should not be removed from its shipping crate before being moved to its final location. Lifting straps should only be attached to the structural steel base, or clevis pins can be used if the fan skid has "lifting holes" in all four corners.

If lifting lugs are provided on the fan housing, only use to lift the housing and not the entire fan. Handle in such a manner to avoid scratching or chipping. Special care must be taken to avoid causing damage from stress or shock. Damaged finish may reduce ability of the fan to resist corrosion.

Fans should never be lifted by the shaft, fan housing, motor, belt guard, windband or accessories.

Storage

- Rotate fan wheel monthly and purge bearings once every three months
- Energize fan motor once every three months
- Store belts flat to keep them from warping & stretching
- Store unit in location which does not have vibration
- After storage period, purge grease before putting fan into service

If storage of fan is in a humid, dusty or corrosive atmosphere, rotate the fan and purge the bearings once a month. Improper storage which results in damage to the fan will void the warranty.

Fans are protected against damage during shipment. If the unit cannot be installed and operated immediately, precautions need to be taken to prevent deterioration of the unit during storage. The user assumes responsibility of the fan and accessories while in storage. The manufacturer will not be responsible for damage during storage. These suggestions are provided solely as a convenience to the user.

INDOOR

The ideal environment for the storage of fans and accessories is indoors, above grade, in a low humidity atmosphere which is sealed to prevent the entry of blowing dust, rain, or snow. Temperatures should be evenly maintained between 30°F (-1°C) and 110°F (43°C) (wide temperature swings may cause condensation and "sweating" of metal parts). All accessories must be stored indoors in a clean, dry atmosphere.

Remove any accumulations of dirt, water, ice or snow and wipe dry before moving to indoor storage. To avoid "sweating" of metal parts allow cold parts to reach room temperature. To dry parts and packages use a portable electric heater to get rid of any moisture build up. Leave coverings loose to permit air circulation and to allow for periodic inspection.

The unit should be stored at least 3½ in. (89 mm) off the floor on wooden blocks covered with moisture proof paper or polyethylene sheathing. Aisles between parts and along all walls should be provided to permit air circulation and space for inspection.

OUTDOOR

Roads or aisles for portable cranes and hauling equipment are needed.

The fan should be placed on a level surface to prevent water from leaking into the fan. The fan should be elevated on an adequate number of wooden blocks so that it is above water and snow levels and has enough blocking to prevent it from settling into soft ground. Locate parts far enough apart to permit air circulation, sunlight, and space for periodic inspection. To minimize water accumulation, place all fan parts on blocking supports so that rain water will run off.

Do not cover parts with plastic film or tarps as these cause condensation of moisture from the air passing through heating and cooling cycles.

Fan wheels should be blocked to prevent spinning caused by strong winds.

Inspection & Maintenance during Storage

While in storage, inspect fans once per month. Keep a record of inspection and maintenance performed.

If moisture or dirt accumulations are found on parts, the source should be located and eliminated. At each inspection, rotate the wheel by hand ten to fifteen revolutions to distribute lubricant on motor. If paint deterioration begins, consideration should be given to touch-up or repainting. Fans with special coatings may require special techniques for touch-up or repair.

Machined parts coated with rust preventive should be restored to good condition promptly if signs of rust occur. Immediately remove the original rust preventive coating with petroleum solvent and clean with lint-free cloths. Polish any remaining rust from surface with crocus cloth or fine emery paper and oil. Do not destroy the continuity of the surfaces. Wipe clean thoroughly with Tectyl® 506 (Ashland Inc.) or the equivalent. For hard to reach internal surfaces or for occasional use, consider using Tectyl® 511M Rust Preventive or WD-40® or the equivalent.

Table of Contents

General Information	
Receiving	2
Handling	2
Storage	2
Installation Recommendations	
BCSW-FRP	4
Bases	5
Belt Guards	5
Drain Connections	5
Ductwork / Stacks	5
Rotatable Housing	5
Radial gap, overlap & wheel alignment	6
Flexible Couplings	7
V-Belt Drives	7
Unit Start-Up	8
Vibration	8
Routine Maintenance	9-10
Motors	9
Shaft Bearings	9
V-Belt Drive	10
Unit Identification	10
Parts List	10
Troubleshooting	11
Maintenance Log	Backcover
Warranty	Backcover

CAUTION

When installing a fan, ensure the proper protective devices are used to protect personnel from moving parts and other hazards. A complete line of protective accessories are available from Greenheck including belt guards, shaft guards, and electrical disconnects.

Electrical Disconnects

All fan motors should have disconnects located in close visual proximity to turn off electrical service. Service disconnects shall be locked out when maintenance is being performed.

Moving Parts

All moving parts must have guards to protect personnel. Refer to local codes for requirements as to the number, type and design. Fully secure fan wheel before performing any maintenance. The fan wheel may start “free wheeling” even if all electrical power has been disconnected. Before the initial start-up or any restart, check the belt and shaft guards and the access doors to ensure that they are installed and secure.

Installation

Installations with inlet or discharge configurations that deviate from this standard may result in reduced fan performance. Restricted or unstable flow at the fan inlet can cause pre-rotation of incoming air or uneven loading of the fan wheel yielding large system losses and increased sound levels. Free discharge or turbulent flow in the discharge ductwork will also result in system effect losses. Refer to the following diagrams for the most efficient installation conditions.

Ducted Inlet Installations

Inlet Duct Turns - Installation of a duct turn or elbow too close to the fan inlet reduces fan performance because air is loaded unevenly into the fan wheel. To achieve full fan performance, there should be at least three fan wheel diameter between the turn or elbow and the fan inlet.

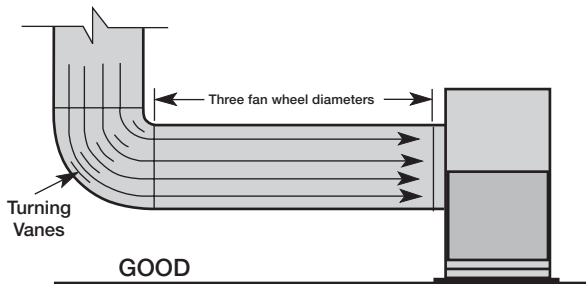
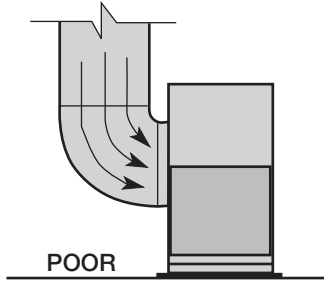

Inlet Spin - Inlet spin is a frequent cause of reduced fan performance. The change in fan performance is a function of the intensity of spin and not easily defined. The best solution is proper duct design and airflow patterns. Turning vanes reduce the effects of inlet spin.

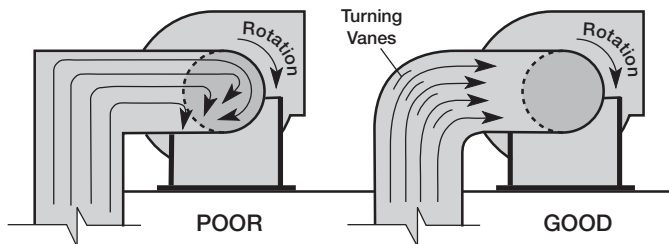

Ducted Outlet Installations

Discharge Duct Turns - Duct turns located near the fan discharge should always be in the direction of the fan rotation.

Fan performance is reduced when duct turns are made immediately off the fan discharge. To achieve cataloged fan performance there should be at least three equivalent duct diameters of straight ductwork between the fan discharge and any duct turns.

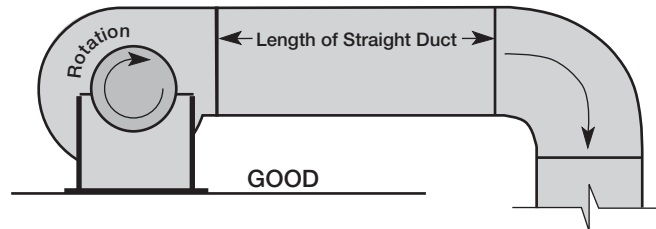
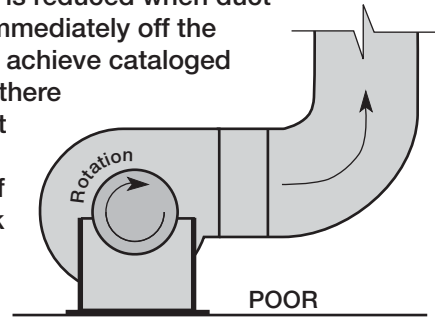

Non-Ducted Installations

Inlet Clearance - Installation of a fan with an open inlet too close to a wall or bulkhead will cause reduced fan performance. It is desirable to have one fan wheel diameter between parallel fan units and a minimum of three-fourths of a wheel diameter between the fan inlet and the wall.

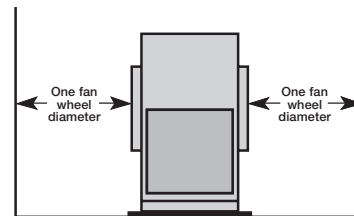

Single Fan Installation

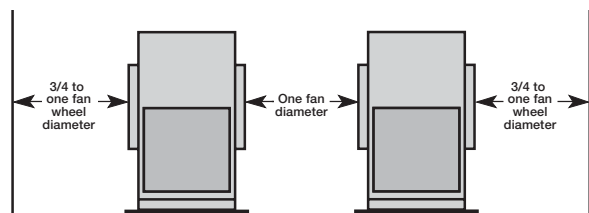

Parallel Fan Installation

Free Discharge - Free or abrupt discharge into a plenum results in a reduction in fan performance. The effect of discharge static regain is not realized.

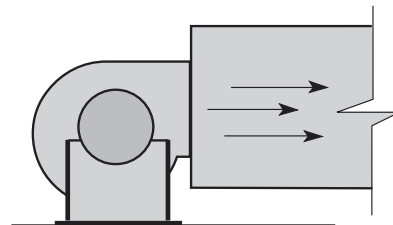

Bases (Foundation and Isolation)

In order to assure continued alignment, a high strength, non-shrink epoxy grout is recommended to provide the desired mechanical properties for support of the fan. This type of support ensures the appropriate transmission of static and dynamic loads to the equipment foundation.

To eliminate vibration and noise from being transferred to the building, vibration isolators should be used. The fan is mounted directly on the base and must be supported for the entire length of the fan base angle. Isolators are installed between the base and the foundation.

After the fan and isolators are installed, the entire assembly must be leveled. Position the level on the base, not the fan shaft, for proper leveling. Additionally, the motor and fan shafts must be level and parallel relative to each other for proper alignment.

Belt Guards

If the belt guard is not factory mounted, then it must be field mounted. **Brackets and mounting hardware are the responsibility of the installer.** Mounting bracket locations vary with motor mounting position, arrangement, and fan type. The bearing supports and fan structure are used in most instances and when the motor is not mounted to the fan itself, a bracket should also be located near it. This information is intended as only a guide and actual field conditions may dictate another mounting location for the guard brackets. Refer to local codes for securing guarding.

Drain Connection

Make sure to either connect the drain or keep it plugged. Never leave the drain open to drain freely. The drain line must be installed using either a U-trap arrangement or an equivalent method (drain leg is submerged in liquid). To obtain a proper seal, the leg length must be greater than the system pressure drop.

Ductwork / Stacks

All ductwork and/or stacks must be self-supporting and independent of the fan. The fan inlet and outlet are not designed to support the connecting duct or stack. The use of flexible connectors is recommended to limit the transmission of stress to the fan. Excessive pressure applied when bolting a flange connection may cause damage to the fan housing or flange.

Rotatable Housings

It may be necessary to rotate the scroll of the fan to achieve a different discharge position than what was originally supplied. Fiberglass fan model BCSW-FRP (sizes 6-25; arr. 4 and 10, Class I, II, III, and IV) has the flexibility to be rotated in the field. This is accomplished by removing the housing bolts, rotating the housing to a new discharge position and reinstalling the bolts.

Radial Gap, Overlap and Wheel Alignment

Efficient fan performance can be maintained by having the correct radial gap, overlap and wheel alignment. These items should be checked after the fan has been in operation for 24 hours and before start-up after the unit has been serviced.

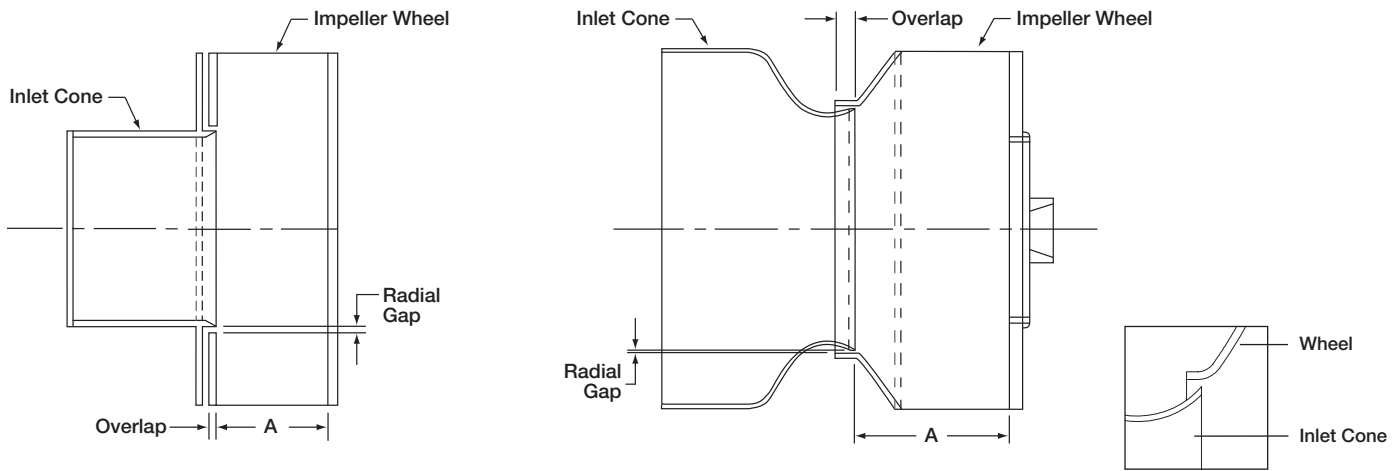

**BCSW-FRP
Sizes 6 thru 10**

**BCSW-FRP
Sizes 15 thru 73**

Unit Size	A Dimension				Radial Gap				Overlap (maximum)			
	± Tolerance (in.)		± Tolerance (mm)		± Tolerance (in.)		± Tolerance (mm)		± Tolerance (in.)		± Tolerance (mm)	
6	3	± 1/8	76	± 3	1/8	± 1/32	3	± 1	3/8	± 1/16	10	± 2
8	4	± 1/8	102	± 3	1/8	± 1/32	3	± 1	7/16	± 1/16	11	± 2
10	5	± 1/8	127	± 3	1/8	± 1/32	3	± 1	7/16	± 1/16	11	± 2
15	5 7/16	± 1/8	138	± 3	1/8	± 1/32	3	± 1	3/4	± 1/16	19	± 2
18	7 1/8	± 1/8	181	± 3	1/8	± 1/32	3	± 1	1 1/8	± 1/16	29	± 2
22	7 15/16	± 1/8	202	± 5	3/16	± 1/32	5	± 1	1 1/4	± 1/16	32	± 2
25	9 1/8	± 1/8	232	± 6	3/16	± 1/32	5	± 1	7/8	± 1/16	22	± 2
30	11 1/8	± 1/8	283	± 10	3/16	± 1/32	5	± 1	1	± 1/16	25	± 2
36	13 1/4	± 1/8	337	± 10	3/16	± 1/16	5	± 2	1 1/4	± 1/16	32	± 2
44	15 1/2	± 1/8	394	± 10	3/16	± 1/16	5	± 2	1 3/4	± 1/16	44	± 2
48	17 1/8	± 1/8	435	± 13	3/16	± 1/16	5	± 2	1 1/2	± 1/16	38	± 2
54	19 3/16	± 1/8	487	± 13	3/16	± 1/16	5	± 2	1 7/16	± 1/16	37	± 2
60	21	± 1/8	533	± 13	7/32	± 1/16	6	± 2	3/4	± 1/16	19	± 2
73	25 3/4	± 1/8	654	± 13	1/4	± 1/16	6	± 2	1 1/4	± 1/16	32	± 2

Radial Gap is adjusted by loosening the housing bolts and centering the inlet cone on the wheel. If additional adjustment is required to maintain a constant radial gap, loosening the bearing bolts and centering the wheel is acceptable as a secondary option.

Overlap is adjusted by loosening the wheel hub from the shaft and moving the wheel to the desired position along the shaft. The transition between the inlet cone and wheel should be as shown; there is a smooth feel to the profile when moving from one component to the other.

Flexible Couplings (Arr. 8 Only)

Check for misalignment between the coupling halves. Parallel and angular misalignment and separation gap are illustrated below. Refer to coupling manufacturer's installation instructions for allowable misalignment and separation gap tolerances. When correcting for misalignment using shims, the shims should only be located under the motor. Do not place shims under the shaft bearings.

After aligning procedure, check for tightness of all coupling component pieces and ensure that they are clean from dirt and debris.

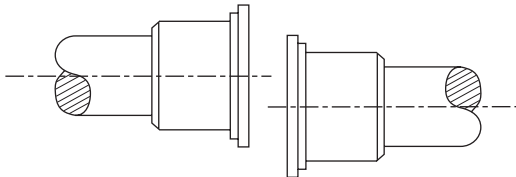

Parallel Misalignment

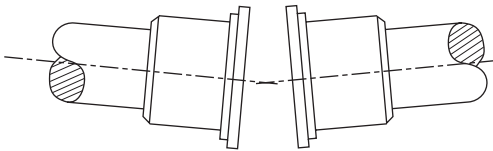

Angular Misalignment

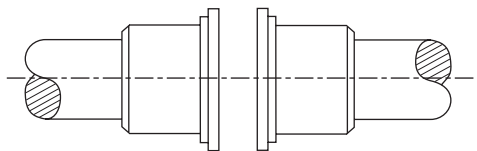

Separation Gap

V-Belt Drives

The V-belt drive components, when supplied by Greenheck Fan Corporation, have been carefully selected for this unit's specific operating condition.

CAUTION

Changing V-belt drive components could result in unsafe operating conditions which may cause personal injury or failure of the following components:

1. Fan shaft
2. Fan wheel
3. Bearings
4. V-belt
5. Motor

V-Belt Drive Installation

1. Remove the protective coating from the end of the fan shaft and assure that it is free of nicks and burrs.
2. Check fan and motor shafts for parallel and angular alignment.
3. Slide sheaves on shafts - do not drive sheaves on as this may result in bearing damage.
4. Align fan and motor sheaves with a straight-edge or string, and tighten.
5. Place belts over sheaves. Do not pry or force belts, as this could result in damage to the cords in the belts.
6. Adjust the tension until the belts appear snug. Run the unit for a few minutes (see section on unit start-up) and allow the belts to seat properly.
7. With the fan off, adjust the belt tension by moving the motor base. (See belt tensioning procedures in the maintenance section of this manual). When in operation, the tight side of the belts should be in a straight line from sheave to sheave with a slight bow on the slack side.

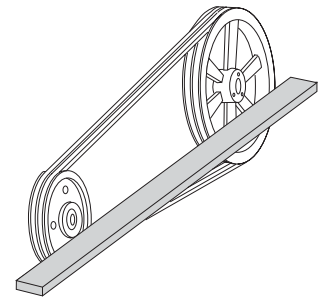

Aligning sheaves with a straight-edge

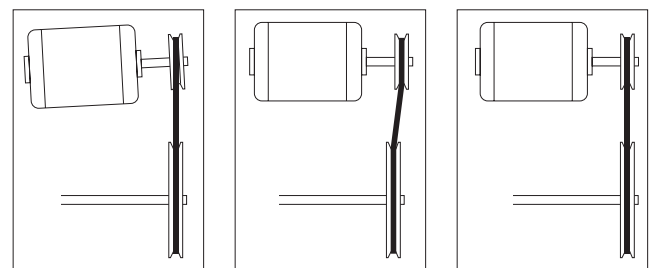

Improper sheave alignment

Proper sheave alignment

Unit Start-Up

1. Disconnect and lock-out all power switches to fan. See warning below.
2. Check all fasteners, set screws and locking collars on the fan, bearings, drive, motor base and accessories for tightness.
3. Rotate the fan wheel by hand and assure no parts are rubbing.
4. Check for bearing alignment and lubrication.
5. Check for coupling alignment (Arr. 8 only).
6. Check the V-belt drive for proper alignment and tension.
7. Check all the guarding (if supplied) for being securely attached and not interfering with rotating parts.
8. Check all electrical connections for proper attachment.
9. Check housing and ductwork, if accessible, for obstructions and foreign material that may damage the fan wheel.
10. Check that the drain is connected, or plugged, and the housing is being properly drained.

WARNING

Disconnect and secure to the "Off" position all electrical power to the fan prior to inspection or servicing. Failure to comply with this safety precaution could result in serious injury or death.

Additional Steps for Initial Start-Up

1. Check for proper wheel rotation by momentarily energizing the fan. Rotation is always determined by viewing the wheel from the drive side and should correspond to the rotation decal affixed to the unit. One of the most frequently encountered problems with Centrifugal Fans is motors which are wired to run in the wrong direction. This is especially true with 3-phase installations where the motor will run in either direction, depending on how it has been wired. To reverse rotation of a 3-phase motor, interchange any two of the three electrical leads.
2. Check for unusual noise, vibration or overheating of bearings. Refer to the "Troubleshooting" section of this manual if a problem develops.
3. Grease may be forced out of the bearing seals during initial start-up. This is a normal self-purging feature of this type of bearing.

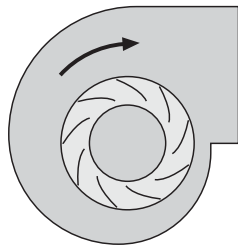

Clockwise Rotation
*Always viewed from
the drive side.*

Vibration

Excessive vibration is the most frequent problem experienced during initial start-up.

Common Sources of Vibration

1. Wheel Unbalance
2. Drive Pulley Misalignment
3. Incorrect Belt Tension
4. Bearing / Coupling Misalignment
5. Mechanical Looseness
6. Faulty Belts
7. Drive Component Unbalance
8. Poor Inlet/Outlet Conditions
9. Foundation Stiffness

Left unchecked, excessive vibration can cause a multitude of problems, including structural and/or component failure.

Many of these conditions can be discovered by careful observation. Refer to the troubleshooting section of this manual for corrective actions. If observation cannot locate the source of vibration, a qualified technician using vibration analysis equipment should be consulted. If the problem is wheel unbalance, the wheel should be sent back to the factory to be properly rebalanced.

Greenheck performs a vibration test on all centrifugal fans before shipping. Three vibration readings are taken on each bearing in the horizontal, vertical, and axial directions. The allowable maximum vibration for belt drive units is 0.078 in/sec. peak (0.05 in/sec. direct drive) velocity filter-in at the fan RPM per AMCA Standard 204. These vibration signatures are a permanent record of how the fan left the factory and are available upon request.

Generally, fan vibration and noise is transmitted to other parts of the building by the ductwork. To eliminate this undesirable effect, the use of heavy canvas connectors is recommended. If fireproof material is required, Flexweave™ 1000 - Type FN-30 can be used.

Routine Maintenance

Once the unit has been put into operation, a routine maintenance schedule should be set up to accomplish the following:

1. Lubrication of bearings and motor (see below).
2. Wheel, housing, bolts and set screws on the entire fan should be checked for tightness.
3. Any dirt accumulation on the wheel or in the housing should be removed to prevent unbalance and possible damage.
4. Springs should be checked for breaks and fatigue. Rubber isolators should be checked for deterioration.
5. Inspect fan impeller and housing looking for fatigue, corrosion, or wear.

When performing any service to the fan, disconnect the electrical supply and secure fan impeller.

Motors

Motor maintenance is generally limited to cleaning and lubrication. Cleaning should be limited to exterior surfaces only. Removing dust and grease build up on the motor housing assists proper motor cooling. Never wash-down motor with high pressure spray. Greasing of motors is only intended when fittings are provided. Many fractional motors are permanently lubricated for life and require no further lubrication. Motors supplied with grease fittings should be greased in accordance with the manufacturer's recommendations. When motor ambient temperature does not exceed 104°F (40°C), the grease should be replaced after 2000 hours of running time.

CAUTION

When operating conditions of the fan are to be changed (speed, pressure, temperature, etc.), consult Greenheck to determine if the unit can operate safely at the new conditions.

Shaft Bearings

The bearings for Greenheck fans are carefully selected to match the maximum load and operating conditions of the specific class, arrangement, and fan size. The instructions provided in this manual and those provided by the bearing manufacturer, will minimize any bearing problems. Bearings are the most critical moving part of the fan, therefore special care is required when mounting them on the unit and maintaining them.

Refer to the following chart and the manufacturers instructions for grease types and intervals for various operating conditions. Never mix greases made with different bases. This will cause a breakdown of the grease and possible failure of the bearing.

Recommended Fan Bearing Lubrication Schedule - Standard Grease Lubrication Schedule in Months*								
Fan RPM	Bearing Bore (inches)							
	1/2 - 1	1 1/8 - 1 1/2	1 5/8 - 1 7/8	1 15/16 - 2 1/16	2 7/16 - 3	3 3/16 - 3 1/2	3 15/16 - 4 1/2	4 15/16 - 5 7/8
To 250	12	12	12	12	12	12	10	8
500	12	12	10	10	8	7	5	4
750	12	9	8	7	6	4	3	2
1000	12	7	6	5	4	3	2	1
1250	12	6	5	4	3	2	1	0.5
1500	12	5	4	3	2	1	0.5	
2000	12	3	2	2	1	0.5	0.25	
2500	12	2	2	1	0.5	0.25		
3000	12	2	1	0.5	0.25			
3500	12	1	0.5	0.25				
4000	12	0.5	0.25					
5000	12	0.25						
# of shots**	4	8	8	10	16	25	41	57

*Suggested initial greasing interval is based on 12 hour per day operation and 160°F maximum housing temperature. For continuous (24 hour) operation, decrease greasing interval by 50%.

- If possible, relubricate with grease while in operation without endangering personnel.
- For ball bearings (operating) relubricate until clean grease is seen purging at the seals. Be careful not to unseat the seal by over lubricating.
- For ball bearings (idle) add 1-2 shots of grease up to 2 in. bore sizes, and 4-5 shots of grease above 2 in. bore sizes with hand grease gun.
- For roller bearings, relubricate with 4 shots of grease up to 2 in. bore size, 8 shots for 2-5 in. bore size, and 16 shots above 5 in. bore size with hand grease gun.
- Adjust lubrication frequency based on condition of purged grease.
- A high quality lithium base grease conforming to NLGI Grade 2 consistency is recommended.
- The use of synthetic lubricants will increase lubrication intervals by approximately three (3) times.

WARNING

Lubricate bearings prior to periods of extended shutdowns or storage and rotate shaft monthly to aid in preventing corrosion. If the fan is stored more than three months, the bearings should be purged with new grease prior to start-up.

V-Belt Drives

V-belt drives must be checked on a regular basis for wear, tension, alignment and dirt accumulation. Premature or frequent belt failures can be caused by improper belt tension—either too loose or too tight—or misaligned sheaves. Abnormally high belt tension or drive misalignment will cause excessive bearing loads and may result in failure of the fan and/or motor bearings. Conversely, loose belts will cause squealing on start-up, excessive belt flutter, slippage, and overheated sheaves. Either excessively loose or tight belts may cause fan vibration.

When replacing V-belts on multiple groove drives all belts should be changed to provide uniform drive loading. Do not pry belts on or off the sheave. Loosen belt tension until belts can be removed by simply lifting the belts off the sheaves. After replacing belts, insure that slack in each belt is on the same side of the drive. Belt dressing should never be used.

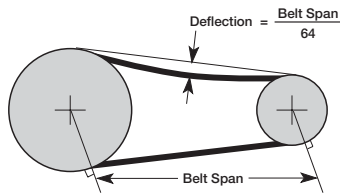

Do not install new belts on worn sheaves. If the sheaves have grooves worn in them, they must be replaced before new belts are installed.

The proper tension for operating a V-belt drive is the lowest tension at which the belts will not slip at peak load conditions. Check belt tension before start up and after the first 24 hours of operation. The belt tension should also be checked periodically thereafter.

Parts List

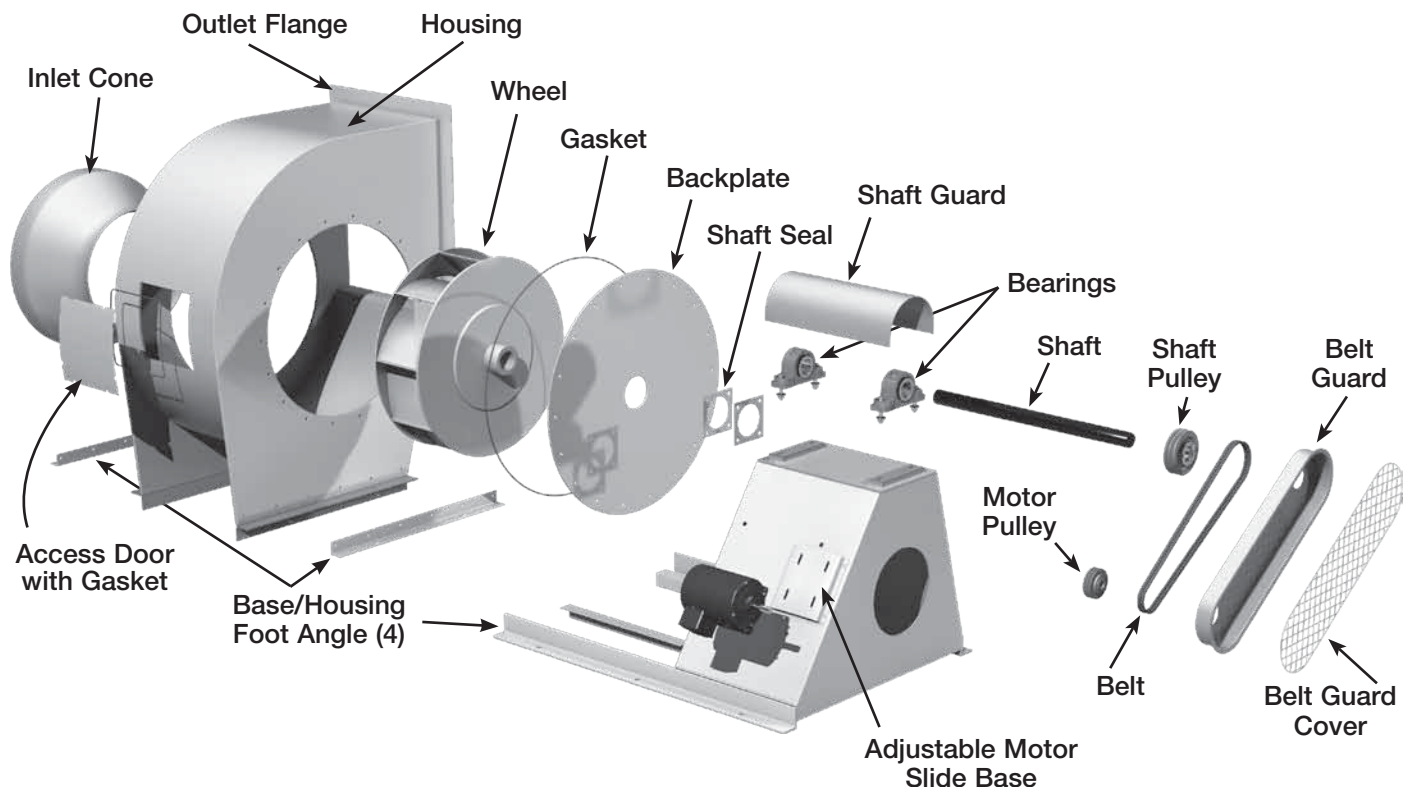

Unit Identification

This tag is an example of an identification label on the fan. The information provides general details about the fan, as well as containing specific information unique to the unit. When contacting your Greenheck representative with future needs or questions, please have the information on this label available.

	
MODEL	<input type="text"/>
S/N	<input type="text"/>
MARK	<input type="text"/>
MAX FRPM @ 70° F	
<input type="text"/>	

Model = General description of fan

S/N = Serial Number assigned by Greenheck, which is a unique identifier for every unit

Mark = Customer supplied identification

Tags are mounted on the drive frame in an area which is clearly visible, usually near the fan outlet on the drive side of the fan. The exact tag location may differ due fan model and size.

Troubleshooting

Problem	Cause	Corrective Action
Excessive Noise	Wheel rubbing (inlet)	Adjust wheel. Tighten wheel hub or bearing collars on shaft.
	V-belt drive	Tighten Sheaves on motor/fan shaft. Adjust belt tension. Align sheaves properly (see V-Belt Drives section). Replace worn belts or sheaves.
	Bearings	Replace defective bearing(s). Lubricate bearings. Tighten collars and fasteners.
	Wheel unbalance	Clean all dirt off wheel. Check wheel balance, rebalance if necessary.
Low CFM	Fan	Check wheel for correct rotation. Increase fan speed.*
	Duct system	See page 3.
High CFM	Fan	Decrease fan speed.
	Duct system	Resize ductwork. Access door, filters, grilles not installed.
Static Pressure Wrong	Duct system has more or less restriction than anticipated	Change obstructions in system. Use correction factor to adjust for temperature/altitude. Resize ductwork. Change fan speed.*
High Horsepower	Fan	Check rotation of wheel. Reduce fan speed.
	Duct system	Resize ductwork. Check proper operation of face and bypass dampers. Check filters and access doors.
Fan Doesn't Operate	Electrical supply	Check fuses/circuit breakers. Check for switches turned off or disconnected. Check for correct supply voltage.
	Drive	Check for broken belts. Tighten loose pulleys.
	Motor	Assure motor is correct horsepower and not tripping overload protector.
Overheated Shaft Bearing	Lubrication	Check for excessive or insufficient grease in the bearings.
	Mechanical	Replace damaged bearing. Relieve excessive belt tension. Align bearings. Check for bent shaft.
Excessive Vibration	Belts	Adjust tightness of belts. Replacement belts should be a matched set.
	System unbalance	Check alignment of shaft, motor and pulleys. Check wheel balance, rebalance if necessary.
	Coupling misalignment	Check alignment between coupling, motor and fan shafts. Any adjustments should be made per coupling manufacturer's instructions. Shim only under motor.

* Always check motor amps and compare to nameplate rating. Excessive fan speed may overload the motor and result in motor failure. Do not exceed the maximum cataloged RPM of the fan.

NOTE: Always provide the unit model and serial numbers when requesting parts or service information.

Maintenance Log

Date _____ Time _____ AM/PM
Notes: _____

Date _____ Time _____ AM/PM
Notes: _____

Date _____ Time _____ AM/PM
Notes: _____

Date _____ Time _____ AM/PM
Notes: _____

Date _____ Time _____ AM/PM
Notes: _____

Date _____ Time _____ AM/PM
Notes: _____

Warranty

Greenheck warrants this equipment to be free from defects in material and workmanship for a period of one year from the shipment date. Any units or parts which prove defective during the warranty period will be replaced at our option when returned to our factory, transportation prepaid. Motors are warranted by the motor manufacturer for a period of one year. Should motors furnished by Greenheck prove defective during this period, they should be returned to the nearest authorized motor service station. Greenheck will not be responsible for any removal or installation costs.

As a result of our commitment to continuous improvement, Greenheck reserves the right to change specifications without notice.

Greenheck Catalog Fiberglass Centrifugal Fans, Model BCSW-FRP, provides additional information describing the equipment, fan performance, available accessories, and specification data.

AMCA Publication 410-96, Safety Practices for Users and Installers of Industrial and Commercial Fans, provides additional safety information. This publication can be obtained from AMCA International, Inc. at: www.amca.org.



Phone: (715) 359-6171 • Fax: (715) 355-2399 • E-mail: gfcinfo@greenheck.com • Website: www.greenheck.com

Free Manuals Download Website

<http://myh66.com>

<http://usermanuals.us>

<http://www.somanuals.com>

<http://www.4manuals.cc>

<http://www.manual-lib.com>

<http://www.404manual.com>

<http://www.luxmanual.com>

<http://aubethermostatmanual.com>

Golf course search by state

<http://golfingnear.com>

Email search by domain

<http://emailbydomain.com>

Auto manuals search

<http://auto.somanuals.com>

TV manuals search

<http://tv.somanuals.com>