

Modular Make-Up Air Unit Model DGX

- Direct Gas-Fired Heating
- Evaporative • Chilled Water • DX Cooling



Model DGX Direct Gas-Fired Make-Up Air Unit

The Greenheck model DGX is a 100% efficient direct gas-fired heating and ventilating unit. Chilled water, DX, and evaporative cooling options are also available for combination heating and cooling requirements.

The DGX is designed for providing make-up air to commercial and industrial facilities. Airflow volumes range from 800 to 48,000 cfm with heating output capacities up to 4,800,000 Btu/hr.

Durable Construction

Designed for maximum weather resistance, DGX housings are constructed of heavy gauge G90 galvanized steel. Lifting lugs are standard.

Direct Gas-Fired System

- High quality cast aluminum burners with stainless steel mixing plates
- Maxitrol electronic modulation burner control
- Flame safeguard with digital fault indicator capability (over 400,000 Btu/hr)
- 25:1 turn down ratio

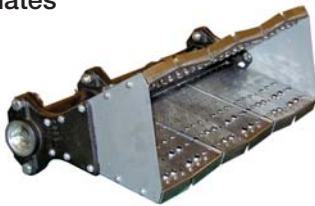

Control Center

The control center includes the following standard components:

- 24 volt control voltage
- Magnetic motor starter with solid state overload protection
- Control transformer
- Disconnect switch
- Distribution terminal strip



Premium grade control components are selected for reliable operation. All electrical components are UL Listed, recognized, or classified, and factory prewired for single point power connection.

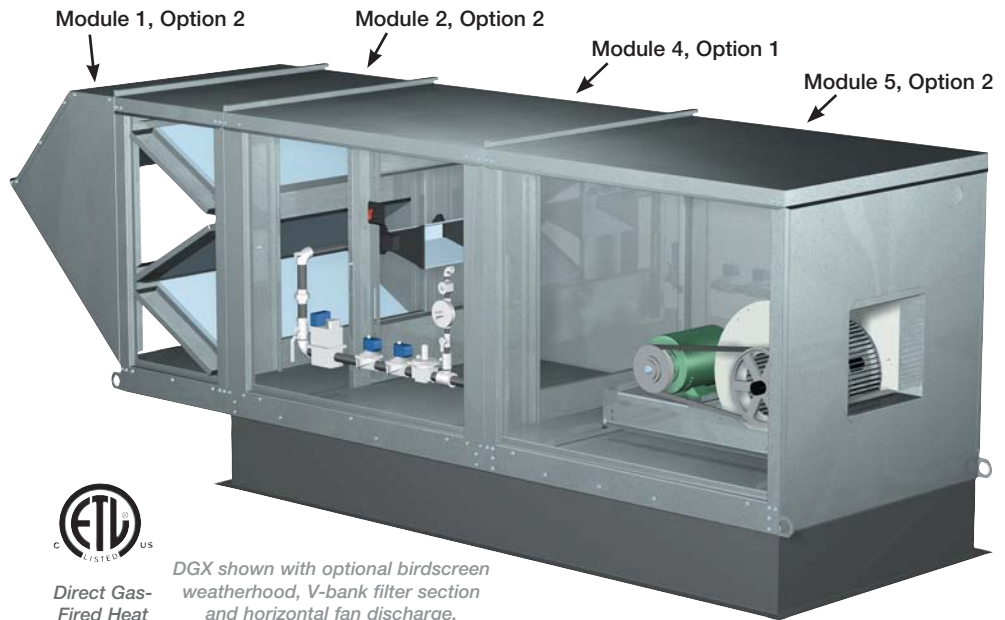

Direct Gas-Fired Heat

DGX shown with optional birdscreen weatherhood, V-bank filter section and horizontal fan discharge.

Vibration Isolators

The entire fan and motor assembly is mounted on neoprene vibration isolators to minimize noise transmission into the building. Spring vibration isolators are available in lieu of neoprene isolators.



Reliable Fan Performance

Air performance ratings from Greenheck's accredited test chamber ensure accurate data.

Double width, double inlet forward curved wheels for high efficiency and low sound levels are constructed of heavy gauge steel. Wheels are balanced to ensure vibration free operation.

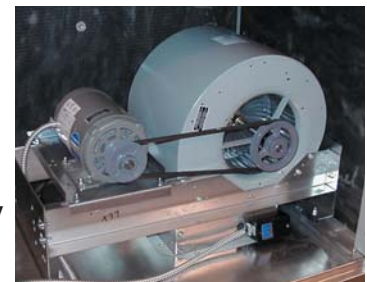

Access Panels















Large access panels are provided for easy inspection and maintenance of motors, drives, fan wheels, filters, and heater controls.

Factory Wired and Tested

All units are tested prior to shipment to ensure proper operation of the gas train, electrical components, and airflow controls.



MODULE SELECTION OPTIONS

	Module 1 INTAKE	Module 2 FILTER	Module 3 COOLING	Module 4 HEATING	Module 5 DISCHARGE
Option 1	<p>None requires Module 2, Option 2</p>	<p>None</p>	<p>None</p>	 Direct Gas Furnace 100% Outdoor Air	 Downblast Discharge
Option 2	 Birdscreen Weatherhood requires Module 2, Option 2	 V-Bank Filters Pleated or Aluminum Mesh	 *Cooling Coil – CW, DX (standard capacity)	 Direct Gas Furnace Recirculation - requires Module 2, Option 3	 Horizontal Discharge
Option 3	 Filtered Weatherhood	 80/20 Filtered Recirculation	 *Cooling Coil – CW, DX (high capacity)	 Direct Gas Furnace Variable Air Volume	 Upblast Discharge
Option 4	 Louvered Weatherhood	<p>*Chilled water or direct expansion (DX) cooling is available with the model DGX. The cooling section includes the cooling coil, sloped stainless steel drain pan and insulated double wall construction. Drain and coil connections are stubbed through the wall for convenience.</p> <p>For proper coil sizing, use Greenheck CAPS selection software or contact your local representative. Four row and six row chilled water or DX coils are available with airflow capacity up to 11,000 cfm. Cooling coil sections are installed upstream of the fan section for a draw through arrangement and provide a streamlined transition to adjacent DGX sections. DX coils require remote condensing units.</p> <ul style="list-style-type: none"> • Module 2 is not available with the Evaporative Cooler section (Module 1, Option 6) • Cooling Coil modules (Module 3, Option 2 & 3) are not available with Recirculation (Module 2, Option 3) • Optional intake dampers available on Cooling Coil section (Module 3, Option 2 & 3) • Module 1, Option 3, 4 & 5 are not available on Housing 35 and larger 			
Option 5	 Thru-Wall				
Option 6	 Evaporative Cooling				

Variable Volume

The variable volume option is recommended when a building's exhaust volume will vary. The make-up air volume will track with the exhaust volume, providing only the necessary amount of make-up air.

The variable volume option saves energy by reducing both fan power and gas consumption whenever make-up air requirements are less than the maximum.

Airflow Control Strategies

Greenheck offers four methods of controlling the make-up air volume. All four vary the fan speed for maximum energy savings.

- Variable Frequency Drive controlled by building pressure.
- Variable Frequency Drive controlled manually with a remote potentiometer.
- Variable frequency drive controlled by a 2-10 VDC or 4-20 mA signal.

- 2 speed motor controlled manually with a remote switch.

Burner By-Pass Damper

The Variable Volume option includes a patented burner by-pass damper, which maintains the pressure drop across the burner as air volumes change. This assures that complete and proper combustion occurs. The by-pass damper is self-adjusting, designed for minimal maintenance, and requires no controls.

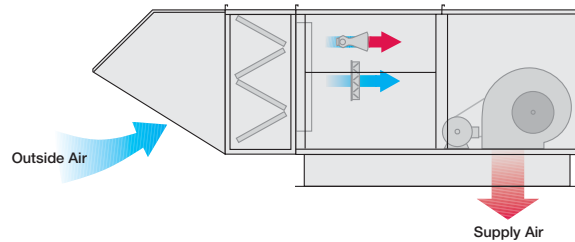

Recirculation

The recirculation option is recommended when the ventilation equipment provides the primary source of heating for the space.

Up to 80% of the air from the space can be recirculated and filtered and then combined with a minimum of 20% outdoor air for a continuous source of fresh air. Only outdoor air is used for combustion to eliminate the possibility of contaminants from the recirculated air crossing over the burner.

Airflow Control Strategies

Greenheck offers four methods of controlling the ratio of recirculated air to outdoor air via motorized dampers.

- Modulating actuator controlled by building pressure.

- Modulating actuator controlled manually with a remote potentiometer.
- Modulating actuator controlled by a 2-10 VDC or 4-20 mA signal.
- Two position actuator controlled manually with a remote switch/time clock.

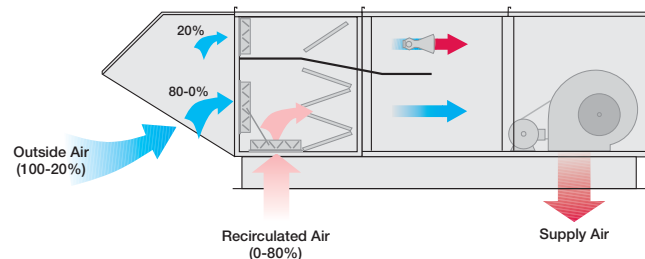

Temperature Control

There are three temperature control options for heat: 1) Discharge Control, 2) Space Control, and 3) DDC Interface Control. Cooling controls are by others.

Discharge Control

A factory installed modulating system controls the gas valve to provide the desired temperature based on a sensor at the fan discharge. A room override option is available to boost the discharge temperature when the space is too cool.



Room Control

Specify this option when the DGX has the primary responsibility for controlling the room temperature. A manually adjusted room thermostat provides feedback to the unit controls, which vary the discharge temperature in order to maintain desired room set point.

DDC Interface Control

Allows for an external signal (0-10 VDC or 4-20 mA) from the building management system to modulate the burner output to satisfy monitored conditions.

Roof Mounted Installation

Model DGX is available for stand alone installations as shown below. Downblast (Arrangement DB), upblast (Arrangement UB), or horizontal (Arrangement HZ) discharge may be specified.

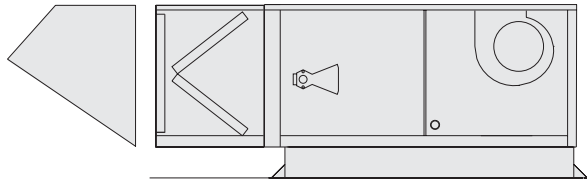

Upblast Discharge - Arrangement UB

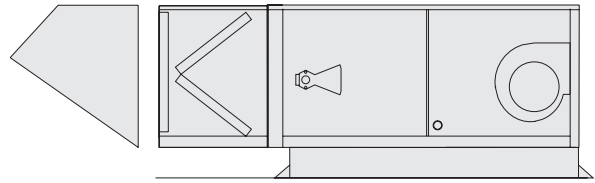

Horizontal Discharge - Arrangement HZ

The Greenheck combination package simplifies installation and reduces field labor costs. The pre-engineered design ensures that the supply fan, exhaust fan, curb, and combination extension components interface properly for kitchen ventilation applications. Equally important, Greenheck combination packages are specifically designed to comply with NFPA 96.

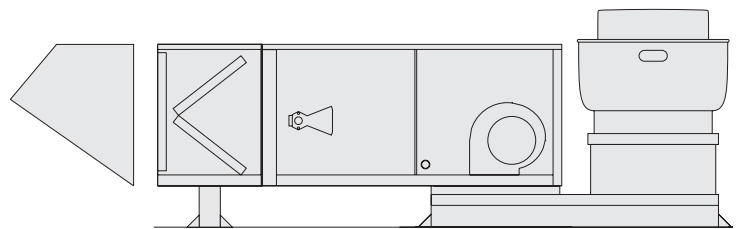

Combination Package - Arrangement DBC

NFPA 96 states:

- Exhaust duct must terminate at least 24 inches above the roof deck
- Fan discharge must be at least 40 inches above the roof deck
- Air intake shall have a horizontal separation of 10 feet from the exhaust discharge

Note: Consult local codes and the authority having jurisdiction if there are questions concerning the use of this product.

The combination curb extension is the component that pulls the Combination Package together, providing a factory engineered interface between the roof curb and the fans. It is also designed to satisfy NFPA 96 requirements - above the roof line - for kitchen hood exhaust.

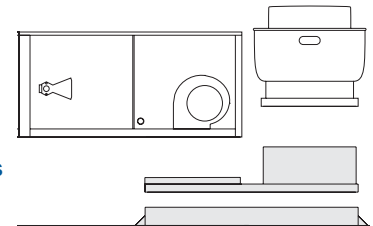

Thru-Wall Installation

Model DGX (Housing 12, 22, & 32 only) is available with a pre-engineered thru-wall installation option, which is ideal when a roof penetration is not desirable.

Factory options that facilitate easy installation and ensure problem-free operation:

Weatherhood: A full down turn design with generous intake area to minimize intake velocity and moisture entrainment.

Thru-Wall Sleeve: Sleeve provides attachment interface between weatherhood and burner section. Accommodates walls up to 15 inches in depth.

Filter Section: Aluminum mesh media filters outdoor air and strips fine mist from the air. A drain pan weeps moisture out the front of the wall sleeve.

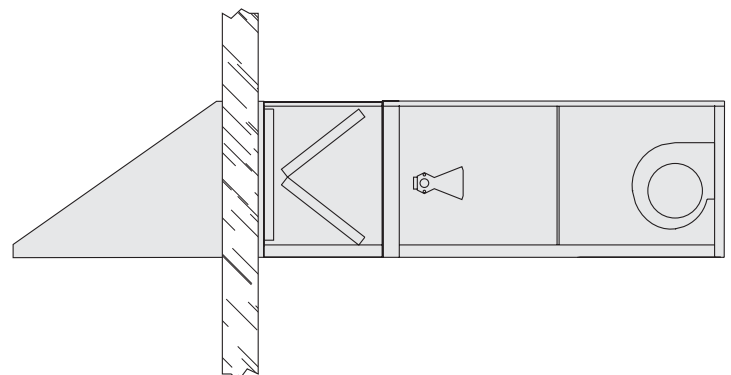

Remote Control Panels

A wide variety of remote control panels are available. Specify the desired combination of switches, thermostats, temperature selectors and indicator lights. A terminal strip at the unit control center and remote panel simplify field control wiring.



Basic remote control panel with thermostat for room temperature control option.



Kitchen style remote panels feature toggle switches and a stainless steel face plate for flush mounting to a wall. The junction box is also included.

Accessories

Special Coatings

Greenheck's Permatector™ coating is available for a durable, long lasting finish. Decorative paints are also available in a variety of colors to match existing building fixtures. Consult your Greenheck representative for paint selections.

Roof Curbs

Factory provided roof curbs are available to ensure compatibility between the make-up air unit and roof curb. Standard construction is G90 galvanized steel.

Duct Adapter

Duct adapter is available with factory supplied roof curbs. The duct adapter allows for easy alignment of the supply duct connection.

V-Bank Filter Section

V-bank filter sections are available with 2-inch washable aluminum mesh or 2-inch 30% efficient disposable filters.

Weatherhood

Three weatherhoods are available: **standard weatherhood** includes birdscreen, **filtered weatherhood** includes aluminum mesh filters, and **louvered intake hood** includes a drainable blade louver at intake with 2-inch aluminum mesh filters.

Motorized Dampers

Intake or discharge dampers are available to prevent backdrafts when the supply fan is not in operation. Intake dampers are factory mounted and wired. Discharge dampers ship loose for field mounting in the supply air duct.

Fiberglass Insulation

One inch fiberglass insulation is available to line the housing to prevent the formation of condensation and to form an acoustical barrier.

Double Wall Construction

An interior metal liner is available to isolate the 1-inch fiberglass insulation from the airstream.

Spring Vibration Isolation

Spring blower vibration isolators are available in lieu of neoprene isolators.

Exhaust Fan Starter(s)

Exhaust fan starters are available factory mounted and wired. Exhaust fan starters allow for an electrical interlock between the supply and exhaust fan(s).

Dirty Filter Switch

A dirty filter switch is available to monitor the pressure drop across the filter section. If the pressure drop across the filters is higher than the field adjustable setting, the dirty filter switch trips indicating the need to clean or replace the filters.

Freeze Protection

Electronic freeze protection is available to automatically shut down the supply fan when the discharge temperature is below the adjustable set point for an extended amount of time. This prevents the unit from discharging non-tempered air into the building and freezing pipes and other temperature sensitive items.

Inlet Air Sensor – Heat

The heating inlet air sensor will automatically turn the heat on and off based on the outdoor air temperature.

Discharge Diffuser

Discharge diffusers are available as either 3-way for horizontal discharge or 4-way for downblast discharge.

Service Receptacle

A 115 volt GFCI outlet is mounted externally in a NEMA 3R box for the convenience of service personnel. A separate 115 volt power source is required.

Auxiliary Contacts

Normally open and normally closed contacts are available for supply fan status and supply fan interlocks.

AIR PERFORMANCE

	Blower Size	CFM		TOTAL PRESSURE in inches WG					
				0.75	1.00	1.25	1.50	1.75	2.00
Housing 12	108	800	RPM	1109	1216	1311	1399	-	-
			BHP	0.26	0.31	0.35	0.40	-	-
		1,200	RPM	1347	1445	1530	-	-	-
			BHP	0.59	0.68	0.75	-	-	-
	109	1,500	RPM	1014	1140	1255	1361	1460	-
			BHP	0.45	0.54	0.63	0.73	0.84	-
		2,400	RPM	1216	1306	1397	1484	1569	1648
			BHP	1.1	1.3	1.4	1.6	1.7	1.9
	110	2,000	RPM	912	1013	1110	1199	-	-
			BHP	0.59	0.71	0.08	0.10	-	-
		3,000	RPM	1097	1172	1244	1315	1386	1455
			BHP	1.4	1.6	1.7	1.9	2.1	2.2
Housing 22	112	2,600	RPM	761	853	934	1009	-	-
			BHP	0.7	0.9	1.0	1.2	-	-
		4,400	RPM	939	1006	1073	1137	1197	1254
			BHP	2.1	2.4	2.6	2.9	3.1	3.3
	115	4,000	RPM	681	756	822	892	-	-
			BHP	1.3	1.5	1.8	2.1	-	-
6,500	RPM	850	906	960	1013	1062	1110		
	BHP	3.5	3.9	4.3	4.7	5.1	5.5		
Housing 32	118	6,500	RPM	609	668	724	777	-	-
			BHP	2.1	2.5	2.8	3.2	-	-
		9,500	RPM	736	783	827	872	914	954
			BHP	4.9	5.4	5.9	6.4	6.9	7.4
	120	10,000	RPM	590	634	678	723	765	803
			BHP	4.0	4.5	5.0	5.6	6.1	6.6
15,000	RPM	763	795	829	861	892	921		
	BHP	10.9	11.6	12.3	13.1	13.8	14.5		
Housing 35	122	15,000	RPM	605	637	667	698	727	755
			BHP	8.3	8.9	9.6	10.4	11.1	11.9
		19,000	RPM	720	746	771	796	821	845
			BHP	15.2	16.1	17.0	17.8	18.6	19.4
	125	19,000	RPM	563	594	625	655	683	711
			BHP	9.8	10.7	11.7	12.8	13.8	14.8
23,000	RPM	643	671	967	723	748	-		
	BHP	15.9	16.9	18.0	19.2	20.4	-		
Housing 38	127	24,000	RPM	451	478	504	530	554	578
			BHP	11.6	13.0	14.3	15.8	17.2	18.6
		30,000	RPM	525	548	571	593	613	-
			BHP	19.6	21.4	23.2	24.9	26.6	-
	130	26,000	RPM	-	412	440	467	494	520
			BHP	-	12.5	13.9	15.2	16.8	18.3
34,000	RPM	454	477	499	519	542	-		
	BHP	21.5	23.1	24.8	26.4	28.3	-		
Housing 42	133	32,000	RPM	371	397	422	446	467	488
			BHP	15.7	17.5	19.2	21.0	22.6	24.3
		40,000	RPM	426	448	470	491	512	531
			BHP	27.1	29.1	31.5	33.7	35.8	37.9
	136	42,000	RPM	405	426	445	464	482	499
			BHP	27.7	29.8	32.0	34.1	36.3	38.5
48,000	RPM	447	465	483	500	-	-		
	BHP	39.0	41.5	44.0	46.4	-	-		

Note: The air performance data shown does not include internal static pressure losses due to items such as filters, dampers, and coils. For exact air performance data based on specific unit configuration, use the Greenheck CAPS selection program.

Typical Specifications

General: Make-up air unit shall be as manufactured by Greenheck or approved equal provided all specifications are met. Greenheck Model DGX equipment is used as the basis of design. Performance to be as scheduled on plans. Make-up air unit shall be ETL listed to ANSI Z83.4 -1999, CSA 3.7 - M99 (for 100% outdoor air) or ANSI Z83.18-2000 (for recirculation).

Gas Train and Controls: Direct gas-fired system shall have a draw through design and field adjustable burner baffles. Gas trains up to 400,000 Btu/hr shall include a direct spark ignition system. Gas trains greater than 400,000 Btu/hr shall include a pilot ignition system and shall have digital coded fault indicator capability. Fault indicator shall provide service history by storing codes for the last five faults. Dual safety shutoff valves shall be industrial duty and use 120 VAC control signals. Temperature control shall incorporate a Maxitrol electronic modulation control system.

Unit Casing and Frames: Unit shall be of internal frame type construction of galvanized steel. All frames and panels shall be G90 galvanized steel. Where top panels are joined there shall be a standing seam to insure positive weather protection. All metal-to-metal surfaces exposed to the weather shall be sealed, requiring no caulking at job site. All components shall be easily accessible through removable doors.

Insulation: Unit casing to be lined with 1 inch fiberglass insulation where specified. Insulation shall be in accordance with NFPA 90A and tested to meet UL 181 erosion requirements. Double wall shall be provided where specified.

Fan Section: Centrifugal fans shall be double width, double inlet. Fan and motor shall be mounted on a common base and shall be internally isolated. All blower wheels shall be balanced. Ground and polished steel fan shafts shall be mounted in permanently lubricated ball bearings or ball bearing pillow blocks. Bearings shall be selected for a minimum (L10) life in excess of 100,000 hours at maximum cataloged speeds.

Motors and Drives: Motors shall be energy efficient, complying with EPACT standards, for single speed ODP and TE enclosures. Motors shall be permanently lubricated, heavy duty type, matched to the fan load and furnished at the specified voltage, phase and enclosure. Drives shall be sized for a minimum of 150% of driven horsepower. Pulleys shall be cast and have machined surfaces, 15 horse power and less shall be supplied with an adjustable drive pulley.

Electrical: All internal electrical components shall be prewired for single point power connection with exception of the larger evaporative cooling sections. All electrical components shall be UL listed, recognized or classified where applicable and wired in compliance with the National Electrical Code. Control center shall include motor starter, control circuit fusing,

control transformer for 24 VAC circuit, integral disconnect switch and terminal strip. Contactors, Class 20 adjustable overload protection and single phase protection shall be standard.

Filter Section: Filter section shall be designed such that velocities across the filters do not exceed 550 feet per minute. Filters shall be 2-inch washable aluminum mesh or 2-inch disposable.

Weatherhood: Weatherhood shall be constructed of G90 galvanized steel with birdscreen mounted at the intake.

Recirculation (optional): Recirculation airflow shall be controlled by adjustment of return damper position. Input signal for return damper shall be from building pressure sensors, potentiometer, external signal, or manual switch. Recirculated air shall not be permitted to pass across the burner. Return air shall be filtered.

Variable Volume (optional): Volume shall be varied by either a 2-speed motor or variable frequency drive. Input signal for fan speed shall be from building pressure sensors, potentiometer, external signal, or manual switch. A self-adjusting burner bypass damper shall maintain a constant air volume across the burner to ensure proper gas combustion. Bypass damper shall operate automatically without an electronic signal.

Cooling Coil (optional): Direct expansion (DX) or chilled water coil shall be factory tested and rated in accordance with ARI 410. Coils shall have copper tubes with permanently expanded aluminum fins, 12 fpi or less. DX coils shall be equipped with distributors to receive expansion valves at the liquid connections. Drain pans shall extend at least 12 inches downstream of coil and be sloped to drain connection. Cooling coil shall meet UL 1995 specifications for non-protected coil.

Evaporative Cooling Section (optional): Evaporative cooling section shall include a galvanized steel housing with louvered intake, 2 inch aluminum mesh filters and a stainless steel evaporative cooling module all provided by the make-up air unit manufacturer. The louver shall be stationary type with drainable blades, and be designed to withstand wind loads of 25 PSF. Evaporative cooling media shall be 12 inches deep, with a UL 900 class II fire rating for a cooling effectiveness of 90%. Drain and overflow connections shall be piped through the side of the evaporative cooling section.

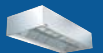
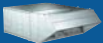
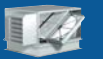

Our Warranty

Greenheck warrants this equipment to be free from defects in material and workmanship for a period of one year from the purchase date. Any units or parts which prove defective during the warranty period will be replaced at our option when returned to our factory, transportation prepaid. Motors are warranted by the motor manufacturer for a period of one year. Should motors furnished by Greenheck prove defective during this period, they should be returned to the nearest authorized motor service station. Greenheck will not be responsible for any removal or installation costs.

As a result of our commitment to continuous improvement, Greenheck reserves the right to change specifications without notice.

Greenheck P.O. Box 410 • Schofield, WI 54476-0410 • Phone (715) 359-6171 • greenheck.com

Free Manuals Download Website

<http://myh66.com>

<http://usermanuals.us>

<http://www.somanuals.com>

<http://www.4manuals.cc>

<http://www.manual-lib.com>

<http://www.404manual.com>

<http://www.luxmanual.com>

<http://aubethermostatmanual.com>

Golf course search by state

<http://golfingnear.com>

Email search by domain

<http://emailbydomain.com>

Auto manuals search

<http://auto.somanuals.com>

TV manuals search

<http://tv.somanuals.com>