

Energy Recovery Ventilator Model ERV

- Commercial
- Institutional

- 400 to 12,000 cfm
- 1.5 in. wg external static pressure

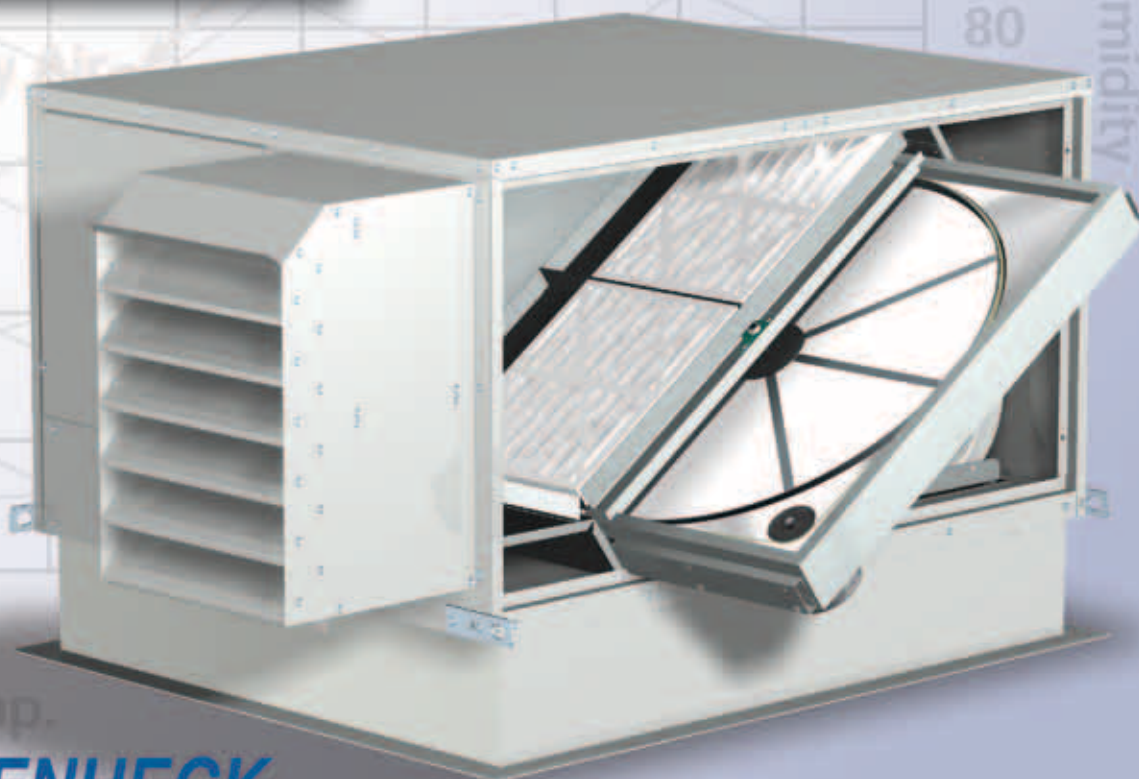

Greenheck's model ERV provides fresh outdoor air to your building and is designed for operation in all climates. This unit incorporates innovative design features with options in energy wheel performance to provide a quality constructed unit with performance flexibility. The flexibility and reliability of these units means the ERV will fit seamlessly into your building to improve your indoor air quality while saving energy and costs.

Design Features:

- 1 Louvered intake weatherhood lowers supply air intake velocities to prevent rain and snow from being pulled in to the unit. Each hood has washable aluminum mesh prefilters blocking debris or leaves.
- 2 2-inch outdoor and return air filters with a MERV 8 (30% efficiency) rating and are set into filter racks that permit easy change out and rigid support.
- 3 Pitched roof and interlocked standing seams eliminates standing water and provides rigid construction.
- 4 18 gauge outer wall construction is available in many alternate coatings. Optional double-wall construction protects insulation from moisture and prevents insulation fibers from entering the airstream. Insulation is 3 lb/ft³ density.
- 5 Multiple energy wheel options allow selection of a unit by what is critical in the design or application:
 - Effectiveness
 - Recovery Efficiency Ratio (RER)
 - Low blower horsepower

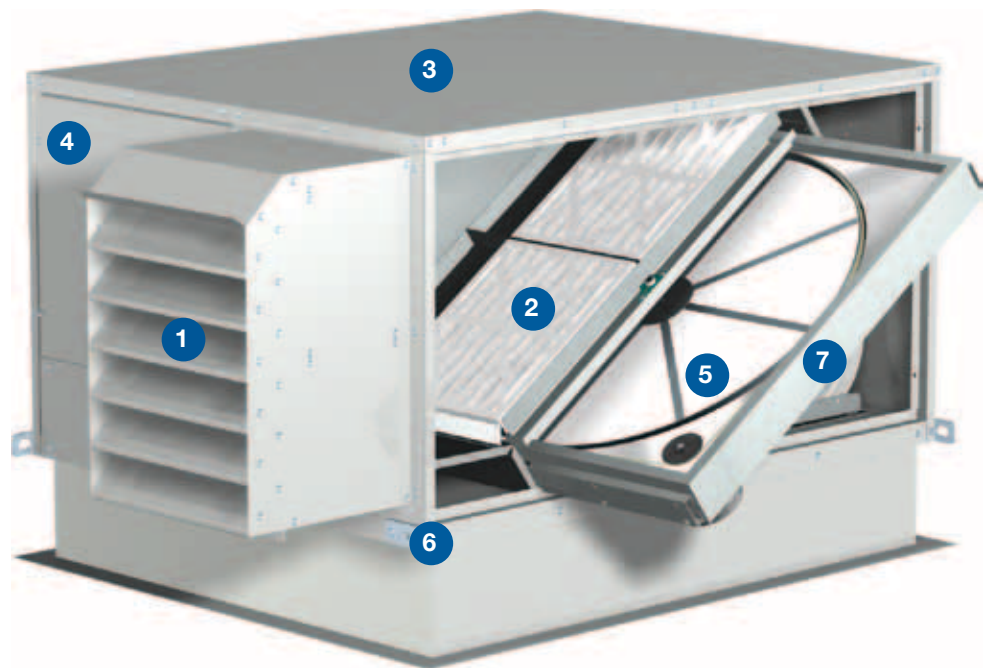

- 6 Integral lifting lugs are included for easy maneuvering and installation of the unit.
- 7 Slide out energy wheel design allows for easy access to the energy wheel.

Additional Features

- Quiet running, forward-curved blowers
- Adjustable motor pulleys for final system balancing
- Factory provided motor starters and disconnect switch in a sealed control center
- Neoprene isolation on blower assembly to minimize sound and vibration transmission
- Bolt-on door design allows for fit in tighter spaces. Optional hinged access is available for roof mount applications.

How does an energy recovery wheel work?

The basic objectives for providing acceptable indoor air quality (IAQ) are to control indoor contaminates levels while maintaining desired indoor air temperature and humidity. Compliance with the prescribed ventilation rates in ASHRAE Standard 62 appear to satisfy the contaminant issue. However, simply increasing outdoor air (OA) requirements with “traditional” HVAC systems may not address the humidity issue properly and often leads to significant energy cost increases.

The best solution for most commercial and institutional facilities will include an enthalpy wheel product. The enthalpy wheel transfers temperature and moisture properties from one airstream to another. The result is capturing the cooling and heating energy before it leaves the HVAC system.

Moving through the unit, the return and supply airstreams pass on opposite sides of a divider panel. The enthalpy wheel rotates between the airstreams transferring up to 75% of the energy present in the exhaust airstream to the supply.

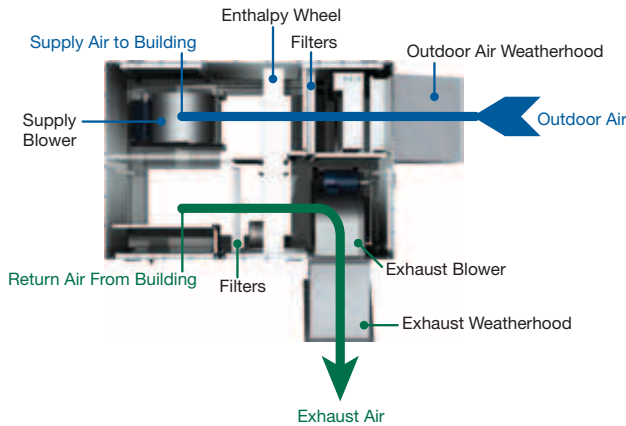
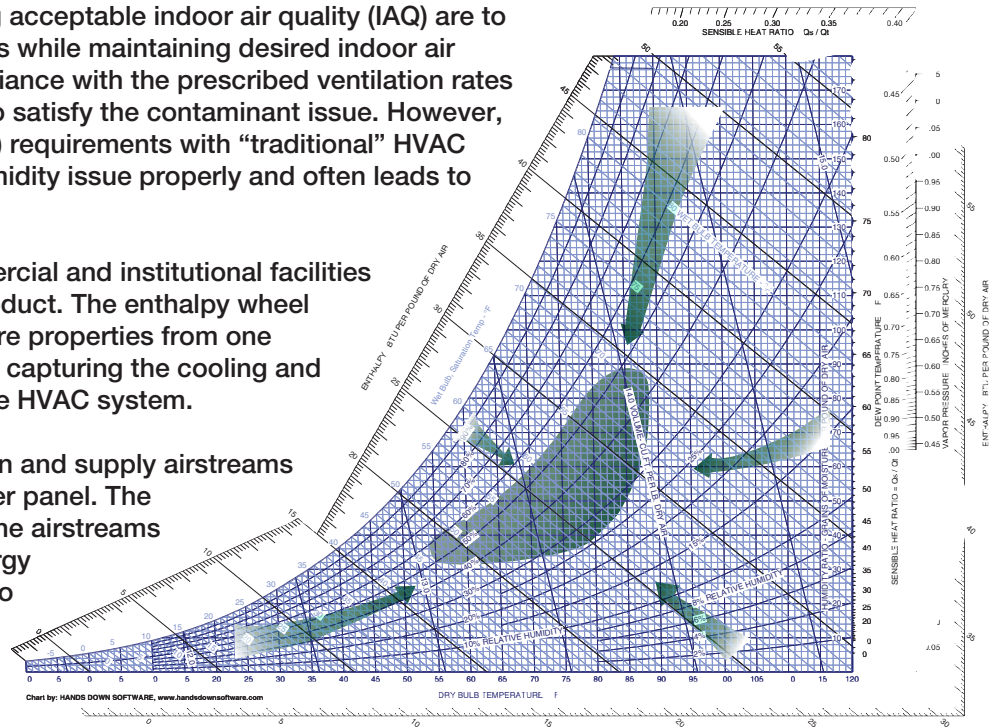

Utilizing an enthalpy wheel to precondition the outdoor air, narrows the operational range of outdoor air conditions which the building’s HVAC equipment is designed to temper. It is this reduction in the outdoor air range that allows for size reduction in heating and cooling equipment and reduced energy costs.

Certifications

ERV’s construction is matched with extensive in-house testing and third-party verification of performance and safety.

Licensed to bear the AMCA seal for Air Performance



Greenheck certifies that the ERV models shown herein are licensed to bear the AMCA seal. The ratings shown are based on tests and procedures performed in accordance with AMCA Publication 211 and comply with the requirements of the AMCA Certified Ratings Program.

Unit is ETL Listed — all internal electrical components are factory wired to a single-point power connection



Every unit is tested at the factory before it is shipped to the job site.

ARI Standard 1060 certified energy wheel performance assures the ERV model will function as required in demanding environments



Energy recovery wheels are certified by the ARI Air-to-Air Energy Recovery Ventilation Equipment Certification Program in accordance with ARI Standard 1060. Actual performance in packaged equipment may vary. Certified ratings are available in the Certified Product Directory at <http://www.ahridirectory.org/ahridirectory/pages/home.aspx>

What is the Benefit with Greenheck Energy Recovery?

For the Building Owner

- Improved Indoor Air Quality (IAQ)**

Introducing fresh, outdoor air to a building is a key component to sustaining excellent indoor air quality. Outdoor air can be very expensive to heat and cool, but the ERV unit can provide an economical approach to delivering outdoor air into a building.

- Energy Savings = Quick Payback**

The energy recovery unit provides energy savings throughout the year. In the summer, the energy recovery unit removes heat and moisture out of the outdoor air, but in the winter, heat and moisture are added back into the fresh airstream. When you combine the energy savings from summer and winter operation, they lead to a very fast payback period. In most parts of the United States, the payback is less than 2 years!

Equipment Reduction Using Energy Recovery on 3000 cfm Outdoor Air							
	Gas Price*	Electric Cost**	Cooling Equipment Reduction (tons)	Annual Summer Cooling Savings	Heating Equipment Reduction (MBH)	Annual Winter Heating Savings	Approximate Payback (Years)***
Boston, MA	1.68	0.1495	8.72	226	161	4544	0.78
Minneapolis, MN	1.14	0.0712	9.55	161	217	3261	0.88
St. Louis, MO	1.34	0.0558	12.1	356	173	3088	0.35
Raleigh, NC	1.48	0.073	11.3	424	138	2790	0.57
Houston, TX	1.10	0.1011	13.0	1701	111	1089	0.22
Tampa, FL	1.59	0.0974	13.1	1779	89	988	0.21
Portland, OR	1.21	0.071	4.17	2	123	2930	2.34
Phoenix AZ	1.13	0.0766	9.40	271	161	1478	1.95

* Average gas price (dollars per therm) per region in the first six months of 2007 (source: Energy Information Administration)

** Average electricity cost (dollars per kWh) in March of 2007 (source: Energy Information Administration)

*** Assumptions: \$3/cfm energy recovery cost; \$650/ton avoided cooling equipment cost; 75.6% effective energy wheel; 12 hrs/day 5 days/week operation

For the Maintenance Personnel

- Low Maintenance Equipment**

Energy Wheel: The most important component in the ERV is the energy wheel. This device should be inspected and cleaned as necessary, which will vary by application and environment. Any cleaning that is required is simplified by the easy accessible wheel with removable segments. Cleaning requires no special equipment (light detergent and water) and can be performed in a location that is convenient to you.

Fans: The blowers that are used in the ERV are centrifugal, forward-curved- type fans. These fans come with easily adjustable pulleys, belt tension bolts and permanently sealed bearings.

Filters: The 2-inch, 30% efficient MERV 8 filters that are included with the unit are designed for easy access and removal.



- Quality Construction**

Greenheck has focused on the manufacturing and unit designs to create well-constructed equipment. Investments in automated manufacturing processes provide accurate and repeatable results, giving excellent part fit and unit strength. Incorporation of innovative designs add to the quality, while keeping maintenance work simple to perform.



- Long-Lasting Equipment**

Because of our high-quality construction, the equipment that goes to the field is made to last. As reassurance to the customer, each ERV unit carries a 1-year warranty from the ship date and the wheel components (segments, cassette, belt, and pulleys) carry a 5-year warranty.

What is the Benefit with Greenheck Energy Recovery?

For the Design Engineer

- **Adhering to ASHRAE Guidelines**

ASHRAE Standard 90.1 provides design guidelines regarding when it is most beneficial to use energy recovery. Depending upon your geographic location and the percentage of outdoor air in the application, ASHRAE recommends when to use energy recovery. An important part of this guideline is that when energy recovery is recommended, the device should be a minimum of **50%** total (sensible and latent) effectiveness according to ARI 1060 testing procedure.

ASHRAE Standard 189.1 provides high performing building design guidelines. This requires even higher energy recovery device performance than Standard 90.1. When energy recovery is recommended, the device shall be a minimum **60%** total (sensible and latent) effectiveness according to ARI 1060 testing procedure.

- **LEED Certification Credits**

For Green Building designs, the ERV offers an excellent way to acquire credits in both Energy and Atmosphere (EA) and Indoor Environmental Quality (EQ) categories towards a LEED certification.



Prepared to Support
Green Building Efforts

- **CAPS Program**

CAPS is Greenheck's comprehensive product selection program. The CAPS program was developed with ease of use and fast selections in mind. There is also useful information available for making selections and educating people who are new to energy recovery technology. CAPS also provides submittals which includes unit overview, electrical information, fan charts, arrangements, engineering drawings, payback information, and psychrometric processes.



- **CSI Specifications**

After a unit has been selected in CAPS, an accurate unit specification is available for use in the job specification. These specifications have been recently updated to the CSI format.

- **Industry Certification**

To ensure performance on the job site, Greenheck emphasizes the need for the 3 major industry certifications for energy recovery units: AMCA Licensed for Air Performance, ETL Listed for safety, and ARI Certification on the energy recovery wheel.

For the Contractor

- **Easy Installation**

- Lifting Lugs
- Single-Point Power
- Bolt-doors for limited clearance applications



Lifting Lugs

These are just a few of the built-in features to make the installation process quick and easy. Our comprehensive Installation, Operation, and Maintenance Manuals are also available online, so the information you need is quick and easy to obtain.

- **Product Approval**

Form, fit and function, the ERV was designed to operate in commercial and institutional applications. With over a decade of installations specific to the energy recovery market, Greenheck's energy recovery product line is well known and accepted throughout the industry.

- **1 – 5-Year Warranty**

Our 1-year unit warranty and 5-year energy recovery wheel warranty lets you to rest easy knowing that we stand behind our product.

Low-Leakage Dampers – Internally mounted for both supply and exhaust

Where code requires low-leakage dampers they can be provided to keep the cold weather out in the winter, or hot and humid weather out during the summer. Since the dampers are wired to a single-point power source, a simple run command sent to the unit powers the dampers open. When your unit is off during unoccupied hours, the dampers close to keep the outdoor air out.



Filters

Standard size 2-inch pleated, medium efficiency filters and filter racks are available for supply and/or exhaust airstreams.

Model	Filter Size	Quantity
ERV-251	16 x 25	1
ERV-361	16 x 20	2
ERV-521	16 x 25	3
ERV-581	16 x 20	6
ERV-522	16 x 25	7

All dimensions shown in inches.

Air Filtration – High-Efficiency Filters

Unit is standard with 2-inch, MERV 8, 30% efficient filters. Optional MERV 13, 85% efficient filters are available to help meet additional LEED requirements or simply improve indoor air quality.



Painted Exterior

For added aesthetics and a long-lasting finish, Greenheck offers many different paint options. Pre painted coatings in either Gray or Desert Sand offer economical options in customizing your unit. If a more specific color is desired, we also offer a wide variety of colors to meet your specific needs.

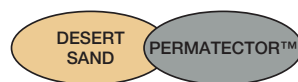

Roof Curbs

For a cohesive fit between the ERV and your building, Greenheck offers a pre-engineered curb design. They are available with duct adaptors to simplify field duct installation and get the unit up and running more quickly.



Double Wall Construction

The supply and exhaust side are internally lined with 20 gauge galvanized steel.

Weatherhoods

A louvered intake hood with 2-inch aluminum mesh filters and exhaust hood with an integral backdraft damper are available.

Hinged Access Doors

Panel side doors are a standard feature on all units. Hinged access doors are available on models ERV-361, -521, -581, -522, and -582. Access doors are removable hinge type with lift and turn latches for access to internal components.

Remote Panel

With the optional remote panel you have control and the information you want. Monitoring lights, on/off time-clock control, or on/off/auto switch are a few of the available options. So whether you want to control the unit operation via a 7-day time clock or simply want to monitor unit performance, the remote panel is the option that you'll need.

Dirty Filter Sensors

Filters require scheduled maintenance to improve air quality and system efficiency. A dirty filter sensor allows you to minimize maintenance frequency to only when it is needed. The dirty filter kit senses when the filters are dirty and sends a signal to our built-in control center. Greenheck offers an optional remote control panel and a “clogged filter” light to tie the signal into.

Rotation Sensor

Adding a wheel rotation sensor to the unit assures you that the energy wheel is operating properly. The sensor sends a signal to the control center of the unit in the rare event that the wheel stops rotating. Greenheck offers an optional remote control panel and a “wheel rotation” light to tie the signal into.

Factory Mounted Sensors

Amp Draw, Pressure, Temperature: Greenheck offers factory mounted sensors that are wired back to the control center, so you can get the information you need to know, exactly where you need to measure it. These sensors can be used to simply monitor unit operation or to actively control the unit with controls by others.

Amp Monitor

Blower amp draw can be monitored through the use of an amperage sensor. These sensors allow for either an analog or digital output based on your system needs.



Wheel Pressure Sensors

In each airstream, a pressure sensor is available to monitor wheel operation. Wheel pressure can be used to indicate a buildup of frost during the cold winter months or can be used as a CFM gauge as the energy wheel is a laminar flow device (i.e. a specific pressure equals a specific CFM).



Temperature Sensors

Wheel performance can be determined with factory mounted temperature sensors. Every compartment can be monitored to know how your unit is operating.



CO₂ Sensor

A good indicator for building health is carbon dioxide (CO₂). Greenheck offers a CO₂ sensor, that can be used to engage the unit based on CO₂ levels, or it can increase or decrease airflows through the use of a variable frequency drive (VFD) on the blowers. The CO₂ sensor can be unit mounted or space mounted depending on your application.



Service Outlet

While performing minimal maintenance on your ERV, a service outlet can provide power when and where it's needed. Shipped loose, the outlet can be mounted in the correct location for your building.

Vapor-Tight Lights

Access doors provide natural lighting during the day, but there may be times when more light is needed to see properly inside the unit. To increase bulb life and to also protect the bulb, Greenheck offers a vapor-tight light.

Blower VFD's

Variable frequency drives are a great tool to control airflow to the space or to maintain duct pressures. With this optional feature, two VFD's are utilized, one per fan for independent and flexible control.



Economizer Control (Free Cooling)

Take advantage of cool outdoor air to handle space loads. A call for cool air is sent to the unit's control center which triggers one of a few different options to bring in fresh cool air:

Energy Wheel On/Off

The wheel cycles off when it's in the free cooling range (temperature or enthalpy), and cycles on when outdoor air is too warm or too cold. This option is recommended when the air is being supplied to an air handling unit or duct heater, and not directly to the space.

Energy Wheel Modulation

The wheel speed modulates to maintain a 55°F discharge temperature. Above 55°F, the wheel is off up to a high-limit temperature setting (typically 70°F). This option is recommended when the air is supplied directly to the space from the ERV or when more precise temperature control is needed.



Frost Protection

Cold climates, in combination with higher indoor humidity levels, may cause frost to form on the energy wheel during normal operation. To protect against frost, we measure the outdoor temperature and the energy wheel pressure drop. When it's cold enough and the wheel pressure is increasing, the wheel is frosting. Only then will the frost methods described below engage. See the "Frost Control Strategy Recommendations" chart on this page for which of the three Greenheck frost methods we recommend for your building.

Timed Exhaust Frost Control

The supply blower cycles on and off based on a factory provided timer. With the supply blower off, the warm exhaust air melts the frost. Once the wheel pressure decreases, the supply blower turns back on.

Modulating Wheel Frost Control

A factory installed variable frequency drive (VFD) slows the wheel down making it less effective. In other words, the slow rotating wheel spends enough time in the warm exhaust airstream to melt the frost. Once the wheel pressure decreases, it returns to full speed. Both blowers operate continuously during this frost mode. Modulating wheel frost control is available on all sizes except the ERV-251.

Preheat Frost Control

An electric preheater is built into the ERV outdoor air intake. When frost occurs, the heater engages, and increases the outdoor air temperature above the frost threshold to melt the wheel. Once the pressure decreases, the heater shuts off.

Frost Control Strategy Recommendations		
Winter Outside Air Design	Winter Indoor Air Design	Recommended Frost Control Strategy
$\geq 10^{\circ}\text{F} (-12.2^{\circ}\text{C})$	$\leq 50\% \text{ RH}$	None
$\geq -5^{\circ}\text{F} (-20.6^{\circ}\text{C}) < 10^{\circ}\text{F} (-12.2^{\circ}\text{C})$	$\leq 35\% \text{ RH}$	Timed Exhaust
$\geq 10^{\circ}\text{F} (-12.2^{\circ}\text{C})$	$\leq 50\% \text{ RH}$	Electric Preheat
$\geq -5^{\circ}\text{F} (-20.6^{\circ}\text{C}) < 10^{\circ}\text{F} (-12.2^{\circ}\text{C})$	$\leq 35\% \text{ RH}$	
$\geq -5^{\circ}\text{F} (-20.6^{\circ}\text{C})$	Any RH	

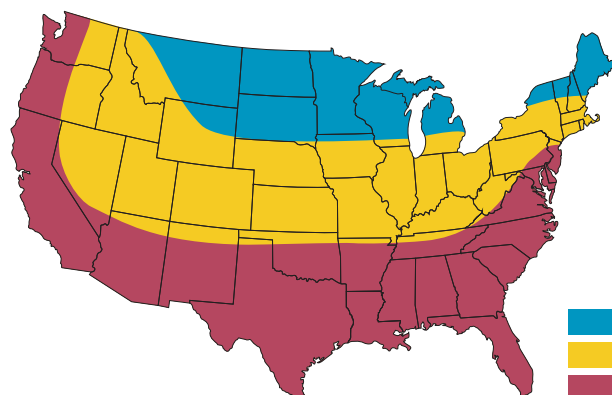

The map at left indicates the frost control options, if any, that are appropriate based on climactic conditions during typical 16 hour per day operation.

- Preheat Frost Control Recommended*
- Timed Exhaust Frost Control Recommended*
- No Frost Control Needed

*Modulating Wheel Frost Control can also be used in these areas.

Interior

This compact design is ideal for the space limitations that routinely complicate interior installations.

Arrangement A

Specify Arrangement A for interior mounting. All ERV sizes are available in this arrangement. Fig. 1 is typical for ERV-251, -361, -521, and -581.

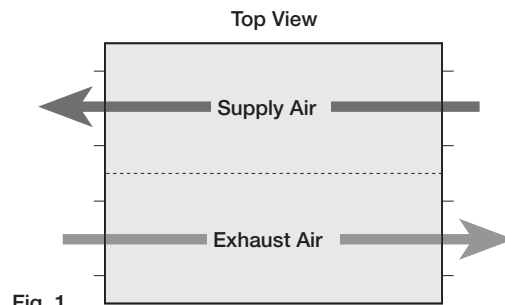

Fig. 1

Arrangement A - Interior Mounted

Exterior

Where roof mount or pad mount installations are preferred, Greenheck offers three arrangements to provide the flexibility to simplify system design and installation. Louvered intake hood and an exhaust hood are standard on Arrangements B, C and D. The housing and hood design minimize re-entrainment of exhaust air.

Arrangement B

Ideal for roof mount installations where both exhaust and supply ducts penetrate the roof deck and attach to the bottom of the energy recovery ventilator. Fig. 2 is typical for ERV-251, -361, -521, and -581.

Arrangement C

Ideal for roof mount installations where the supply airstream is to be routed directly into a rooftop HVAC unit. Exhaust air enters the ERV from below.

Arrangement D

Suited for pad mounting, where both the exhaust and supply ducts connect to the end of the ERV.

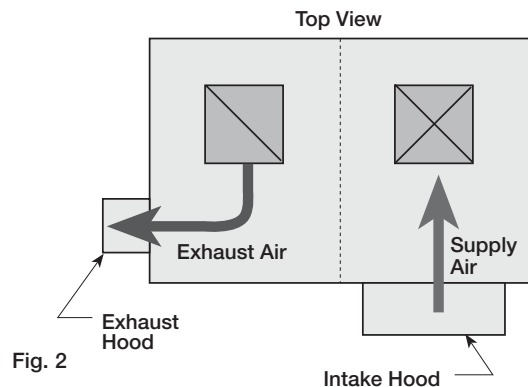

Fig. 2

Arrangement B - Roof Mounted

Dimensions

ERV-251, ERV-361, ERV-521, ERV-581

Model	Exterior Dimensions					Duct Dimensions						Weight (lbs.)
	A	B	C	D	E	F	G	K	L	Q	P	
ERV-251	46	34	27	12	8	10	16	6 $\frac{3}{4}$	7	10	16	340
ERV-361	62	51	34	18	15	18	18	8 $\frac{3}{8}$	11 $\frac{1}{2}$	19	18	860
ERV-521	67	67	44	16	15	24	24	10 $\frac{3}{4}$	13 $\frac{1}{2}$	26	26	1290
ERV-581	75	70	67	16	22	22	27	16	18 $\frac{3}{4}$	28	48	1470

All dimensions shown are in inches. Weight assumes outdoor unit with filters, weatherhoods, and supply damper.

Arrangement A

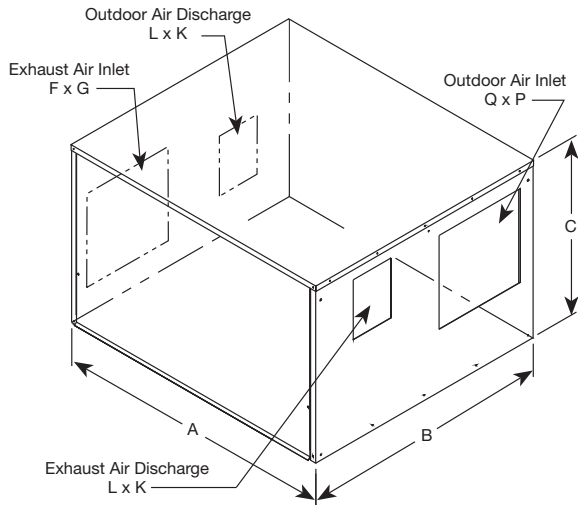

Arrangement B

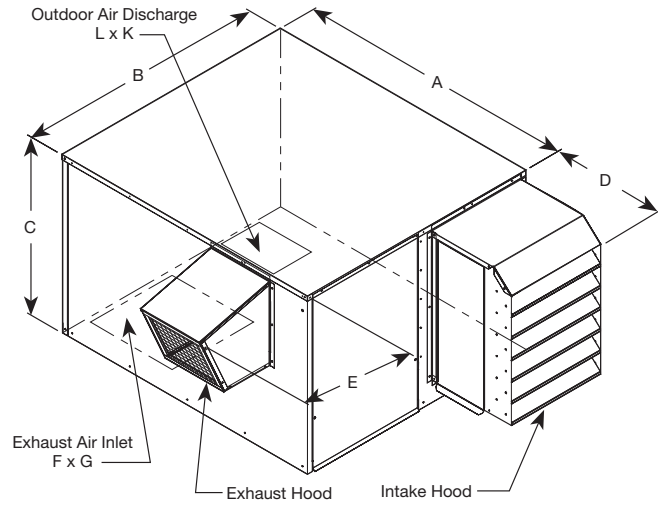

Arrangement C

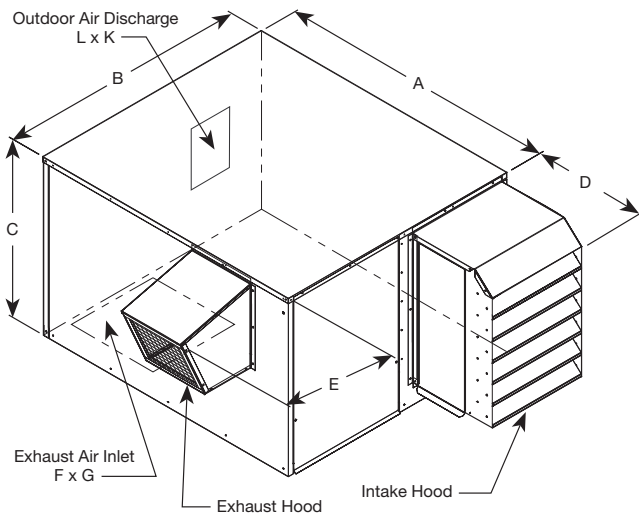

Arrangement D

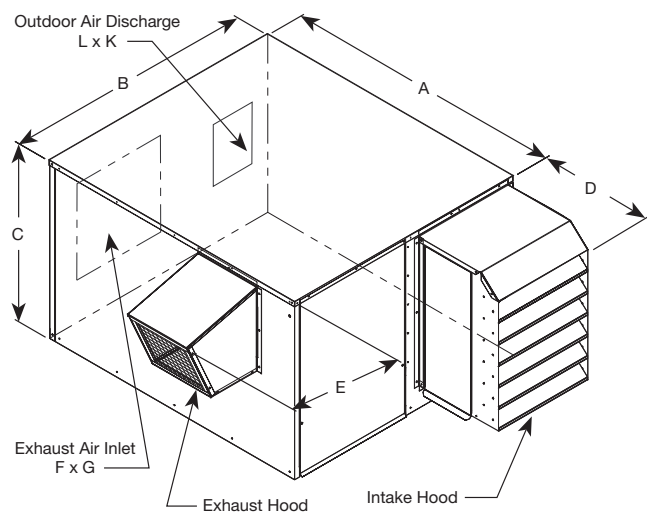

Service Clearance

Installation must allow clearance for access to the energy recovery wheel on the supply side. Minimum clearances are shown in the table at right. Page 4 shows the side panel that enables wheel access.

Model	Supply Side	Exhaust Side
ERV-251	32	30
ERV-361	44	30
ERV-521	60	40
ERV-581	65	40

All dimensions shown are in inches.

Dimensions

ERV-522 and ERV-582

Model	Exterior Dimensions					Duct Dimensions								Weight (lbs.)
	A	B	C	D	E	F	G	H	J	K	L	Q	P	
ERV-522S	124	84	64	16	19	48	25	26	36	16	18 ⁵ / ₈	60	25	3230
ERV-522H	124	84	64	16	19	48	25	26	36	19	22	60	25	3230
ERV-582H	146	97	77	17 ¹ / ₂	26 ³ / ₄	60	28	31	38	23	25	70	30	3700

All dimensions shown are in inches. Weight assumes outdoor unit with filters, weatherhoods, and supply damper.

Arrangement A

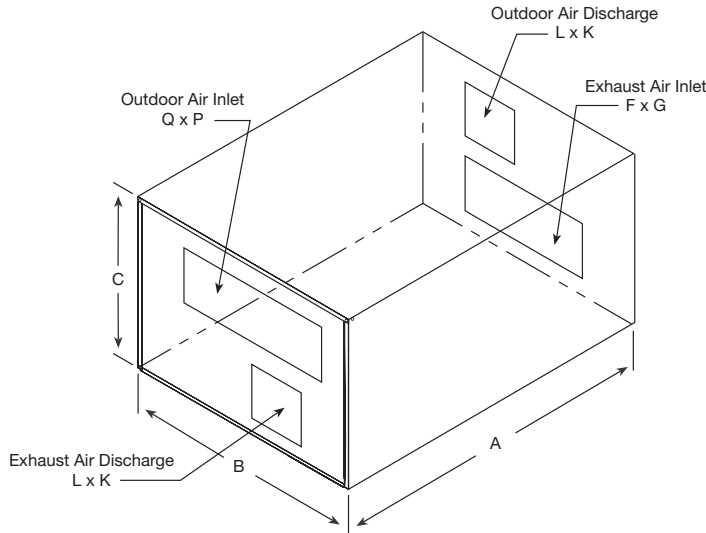

Arrangement B

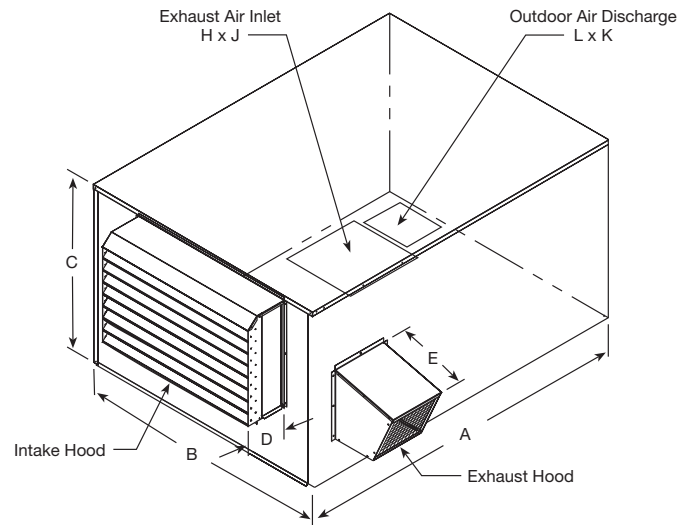

Arrangement C

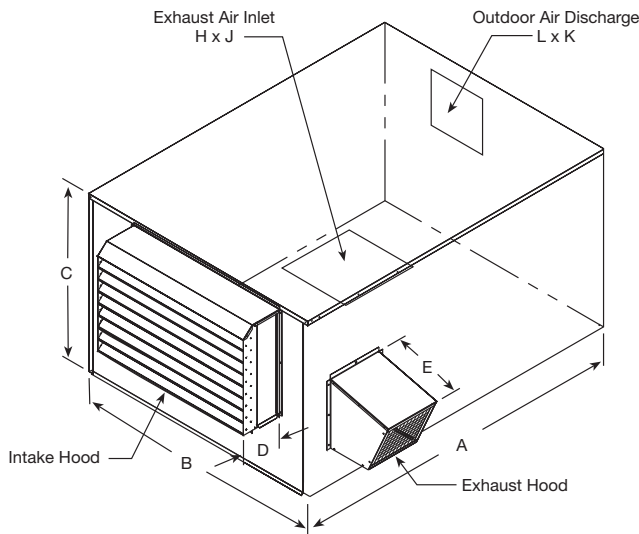

Arrangement D

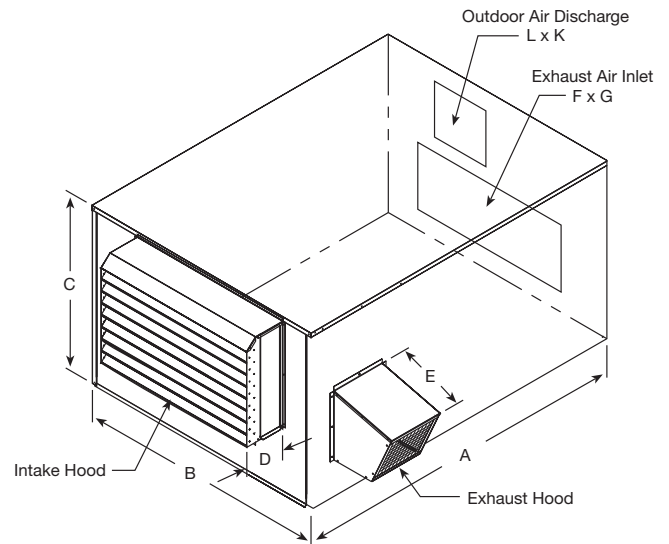

Service Clearance

The installation must allow clearance for access to the energy recovery wheels and servicing. Minimum clearances are shown in the table at right. Model ERV-522 and ERV-582 energy wheels are mounted in an upright position, side by side. For servicing, the energy wheels slide out of the ventilator at opposite corners.

Model	Supply Side	Exhaust Side
ERV-522	38	38
ERV-582	42	42

All dimensions shown are in inches.

Performance Supply and Exhaust - Belt and Direct Drive

The airflow performance data shown applies to arrangement A and is licensed to bear the AMCA Seal for Air Performance. Performance data for other arrangements may differ slightly.

For specific performance for all arrangements, use Greenheck's Computer Aided Product Selection (CAPS) program.

All models are available in A, B, C, and D arrangements.



Greenheck Fan Corporation certifies that the ERV models shown herein are licensed to bear the Air Performance AMCA seal. The ratings shown are based on tests and procedures performed in accordance with AMCA Publication 211 and comply with the requirements of the AMCA Certified Ratings Program.

NOTES:

1. Performance tables show **EXTERNAL static pressure capabilities.**
2. Bhp, watt and amp values shown are for **one blower motor only.**

Model ERV-251 / Direct Drive

ERV-251S (Standard Airflow)

Nominal RPM	Max Amps 115/230	Max. Watts (input)	CFM	EXTERNAL STATIC PRESSURE (in. wg)						
				0.25	0.375	0.50	0.625	0.75	1.00	1.25
950	3.0/1.5	300		563	536	498	450	378		
1150	5.3/2.7	530		700	680	658	634	597	513	
1350	8.6/4.3	855		834	818	801	783	762	711	642

ERV-251H (High Airflow)

Nominal RPM	Max Amps 115/230	Max. Watts (input)	CFM	EXTERNAL STATIC PRESSURE (in. wg)						
				0.25	0.375	0.50	0.625	0.75	1.00	1.25
1150	5.0/2.5	500		802	777	742	706	667		
1340	8.1/4.1	810		958	937	915	887	857	792	
1520	11.5/5.8	1150		1089	1070	1051	1032	1008	954	895

Model ERV-361 / Belt Drive

ERV-361S (Standard Airflow)

CFM	OV		EXTERNAL STATIC PRESSURE (in. wg)							
			0.125	0.250	0.375	0.50	0.75	1.00	1.25	1.50
1000	1495	FRPM	777	863	941	1015	1147	1277	1397	1515
		BHP	0.21	0.25	0.29	0.33	0.41	0.49	0.58	0.69
1200	1794	FRPM	899	974	1043	1109	1232	1343	1453	1557
		BHP	0.34	0.39	0.43	0.48	0.58	0.68	0.78	0.87
1400	2093	FRPM	1023	1091	1153	1212	1324	1429	1527	1618
		BHP	0.52	0.58	0.64	0.68	0.80	0.92	1.03	1.14
1600	2392	FRPM	1149	1212	1269	1323	1424	1520	1613	1701
		BHP	0.75	0.82	0.89	0.95	1.07	1.20	1.34	1.47

ERV-361H (High Airflow)

CFM	OV		EXTERNAL STATIC PRESSURE (in. wg)							
			0.125	0.250	0.375	0.50	0.75	1.00	1.25	1.50
1600	2392	FRPM	1006	1065	1122	1175	1275	1367	1457	1542
		BHP	0.58	0.64	0.69	0.74	0.86	0.96	1.07	1.19
1800	2691	FRPM	1119	1172	1223	1272	1365	1452	1533	1613
		BHP	0.82	0.88	0.93	0.99	1.12	1.25	1.36	1.49
2000	2990	FRPM	1232	1279	1326	1372	1458	1541	1618	1692
		BHP	1.11	1.17	1.23	1.30	1.43	1.58	1.72	1.85
2200	3289	FRPM	1347	1389	1433	1474	1555	1633		
		BHP	1.46	1.53	1.60	1.67	1.81	1.97		

Gross supply air performance ratings (airflow, pressure, and power) are at port 2 with port 1, port 3 and port 4 at 0.0 in. wg. Gross exhaust air performance ratings (airflow, pressure, and power) are to port 3 with port 1, port 2 and port 4 at 0.0 in. wg. Power rating (Bhp) does not include drive losses. Performance ratings do not include the effects of appurtenances in the airstream.

Performance Supply and Exhaust - Belt Drive

Model ERV-521

ERV-521S (Standard Airflow)

CFM	OV		EXTERNAL STATIC PRESSURE (in. wg)							
			0.125	0.25	0.375	0.50	0.75	1.00	1.25	1.50
2,200	2,183	FRPM	830	881	933	981	1072	1155	1238	1315
		BHP	0.72	0.80	0.87	0.95	1.09	1.25	1.41	1.57
2,700	2,679	FRPM	998	1040	1081	1124	1203	1278	1350	1416
		BHP	1.29	1.38	1.47	1.57	1.75	1.93	2.12	2.30
3,200	3,175	FRPM	1168	1203	1240	1274	1345	1412	1477	
		BHP	2.11	2.21	2.32	2.43	2.65	2.86	3.08	

ERV-521H (High Airflow)

CFM	OV		EXTERNAL STATIC PRESSURE (in. wg)							
			0.125	0.25	0.375	0.50	0.75	1.00	1.25	1.50
3,100	3,076	FRPM	980	1017	1054	1089	1159	1226	1290	1355
		BHP	1.57	1.65	1.73	1.82	1.99	2.18	2.36	2.54
3,700	3,671	FRPM	1156	1187	1219	1249	1309	1367	1425	1480
		BHP	2.62	2.72	2.83	2.92	3.12	3.33	3.55	3.77
4,300	4,267	FRPM	1334	1361	1388	1415	1467	1519	1569	
		BHP	4.08	4.20	4.31	4.43	4.65	4.89	5.13	

Model ERV-522

ERV-522S (Standard Airflow)

CFM	OV		EXTERNAL STATIC PRESSURE (in. wg)							
			0.125	0.25	0.375	0.50	0.75	1.00	1.25	1.50
5,000	2,416	FRPM	754	794	831	869	943	1011	1072	1134
		BHP	2.20	2.39	2.57	2.76	3.15	3.54	3.89	4.30
5,750	2,779	FRPM	855	892	924	957	1022	1087	1146	1201
		BHP	3.28	3.49	3.70	3.92	4.33	4.81	5.26	5.67
6,500	3,141	FRPM	956	991	1021	1049	1108	1164	1222	1276
		BHP	4.67	4.90	5.15	5.39	5.88	6.33	6.89	7.41

ERV-522H (High Airflow)

CFM	OV		EXTERNAL STATIC PRESSURE (in. wg)							
			0.125	0.25	0.375	0.50	0.75	1.00	1.25	1.50
6,000	2,067	FRPM	535	581	619	660	731	797	857	913
		BHP	1.57	1.79	1.96	2.16	2.55	2.94	3.33	3.72
7,500	2,584	FRPM	646	686	722	753	818	877	930	983
		BHP	2.90	3.20	3.46	3.68	4.17	4.66	5.12	5.62
9,000	3,100	FRPM	763	794	827	857	910	964	1016	1063
		BHP	4.90	5.20	5.57	5.89	6.42	7.01	7.60	8.18

Model ERV-581

ERV-581H (High Airflow)

CFM	OV		EXTERNAL STATIC PRESSURE (in. wg)							
			0.125	0.25	0.375	0.50	0.75	1.00	1.25	1.50
4,300	2,064	FRPM	637	687	733	772	850	923	988	1055
		BHP	1.20	1.35	1.49	1.61	1.88	2.16	2.42	2.73
5,050	2,424	FRPM	731	774	817	855	922	989	1053	1111
		BHP	1.89	2.05	2.23	2.39	2.68	3.00	3.33	3.65
5,800	2,784	FRPM	826	866	903	939	1004	1061	1120	1177
		BHP	2.79	2.99	3.18	3.38	3.74	4.07	4.44	4.83

Model ERV-582

ERV-582H (High Airflow)

CFM	OV		EXTERNAL STATIC PRESSURE (in. wg)							
			0.125	0.25	0.375	0.50	0.75	1.00	1.25	1.50
9,000	2,254	FRPM	595	629	661	692	746	797	843	888
		BHP	3.61	3.95	4.26	4.54	5.25	5.89	6.48	7.09
10,500	2,630	FRPM	685	713	741	769	820	867	911	952
		BHP	5.60	5.99	6.38	6.74	7.44	8.27	9.03	9.74
12,000	3,005	FRPM	776	800	825	849	897	941	982	
		BHP	8.24	8.66	9.12	9.56	10.36	11.19	12.13	

Gross supply air performance ratings (airflow, pressure, and power) are at port 2 with port 1, port 3 and port 4 at 0.0 in. wg. Gross exhaust air performance ratings (airflow, pressure, and power) are to port 3 with port 1, port 2 and port 4 at 0.0 in. wg. Power rating (Bhp) does not include drive losses. Performance ratings do not include the effects of appurtenances in the airstream.

Motor Specifications

Blower motor information must be specified to select unit. The horsepower, voltage, phase and enclosure availability is presented in the table on the right. If exhaust and supply blower horsepower are different, consult the CAPS program.

Model	Open			TE		Two Speed Open	
	115/1	230/1	230/460/3	230/1	230/460/3	230/1	230/460/3
ERV-251S*	¼	¼	-	-	-	-	-
ERV-251H*	½	½	-	-	-	-	-
ERV-361*	-	¼ - 2	¼ - 2	¼ - 2	¼ - 2	½ - 1	½ - 1½
ERV-521*	-	½ - 3	½ - 5	½ - 1½	½ - 5	½ - 1	½ - 3
ERV-581*	-	-	1 - 5	-	1 - 5	-	1 - 3
ERV-522*	-	1½ - 3	1½ - 15	1½	1 - 15	-	1 - 7½
ERV-582*	-	-	1½ - 15	-	1 - 15	-	1 - 7½

UL Listing is available on most open drip proof motors.

*Energy wheel drive motor is only available with open drip proof motors.

Minimum Circuit Amps (MCA) Calculations for ERV Units

Wheel drive, 24 volt internal control amp and standard electric preheat kW. Single or three phase ERV units

Model	Wheel Drive Amps			24v Control Amps	Standard Electric Preheat kW					
	115	208/230	460		115/1	208/1	230/1	208/3	230/3	460/3
ERV-251	0.6	0.6	NA	0.5	2.5	2.1, 4.1	2.5, 5	NA	NA	NA
ERV-361	NA	1.2	0.6	1	NA	NA	NA	4.1, 8.2, 12.3	5, 10, 15	5, 10, 15
ERV-521	NA	2.8	1.4	1	NA	NA	NA	8.2, 12.3, 15.5	10, 15, 19	10, 15, 20, 25, 30
ERV-581	NA	1.6	0.8	1	NA	NA	NA	12.3, 15.5	15, 19	15, 20, 25, 30, 38
ERV-522	NA	5.6	2.8	1	NA	NA	NA	15.5	19	20, 25, 30, 45
ERV-582	NA	3.2	1.6	1	NA	NA	NA	15.5, 24.5	19, 30	20, 38, 50

NA = not available

MCA Example Calculation

Greenheck ERV selected: ERV-361S-B, 2 hp supply motor, 1½ hp exhaust motor, 15kW preheater operating at 460 volt, three phase.

- Step 1: Consult NEC table (not shown) for 2 hp supply motor amps = 3.4 A
- Step 2: Consult NEC table (not shown) for 1½ hp exhaust motor amps = 2.6 A
- Step 3: Calculate 15kW preheater amp draw = $15,000W / [460 * \sqrt{3}] = 18.8 A$
If no preheater is used skip step 3
- Step 4: Wheel drive amps for ERV-361 from table above = 0.6 A
- Step 5: 24v Control Amps for ERV-361 from table above = 1.0 A
- Step 6: MCA = Amperage total from steps 1 thru 5 x 1.25
MCA = (3.4 + 2.6 + 18.8 + 0.6 + 1.0) 1.25 = 33 A

Model	CFM	Filter Pressure Drop	
		Intake Hood with 2-inch aluminum filters	Pleated 2-inch filters
ERV-251	500	0.09	0.09
	1,000	0.32	0.19
ERV-361	1,000	0.09	0.10
	2,200	0.45	0.28
ERV-521	2,500	0.13	0.14
	4,500	0.45	0.32
ERV-581	4,500	0.17	0.15
	5,500	0.30	0.24
ERV-522	6,000	0.15	0.14
	9,000	0.40	0.25
ERV-582	9,000	0.13	0.16
	12,000	0.45	0.27

Note: Calculations are approximate, use our Computer Aided Product Selection (CAPS) program for exact MCA calculations.

The ERV unit can add to the benefit of a building design anywhere that outdoor air is required and the exhaust air is considered “clean” (ASHRAE class 1 or class 2 air ratings). Some examples of commercial and institutional applications where energy recovery units have been utilized are given below.

- | | | | |
|----------------------|----------------|------------------|----------------|
| Animal Shelters | Bars and Clubs | Churches | Dormitories |
| Locker Rooms | Nursing Homes | Office Buildings | Printing Shops |
| Restaurants | Schools | Function Halls | Casinos |
| Veterinary Hospitals | | | |

With Ducted Air Handlers

The ERV unit may be combined with ducted air handling units or fan coil boxes. A single energy recovery ventilator may provide fresh outdoor air for multiple air handling units or in a one-to-one ratio where a single energy recovery ventilator and air handler serve one space.

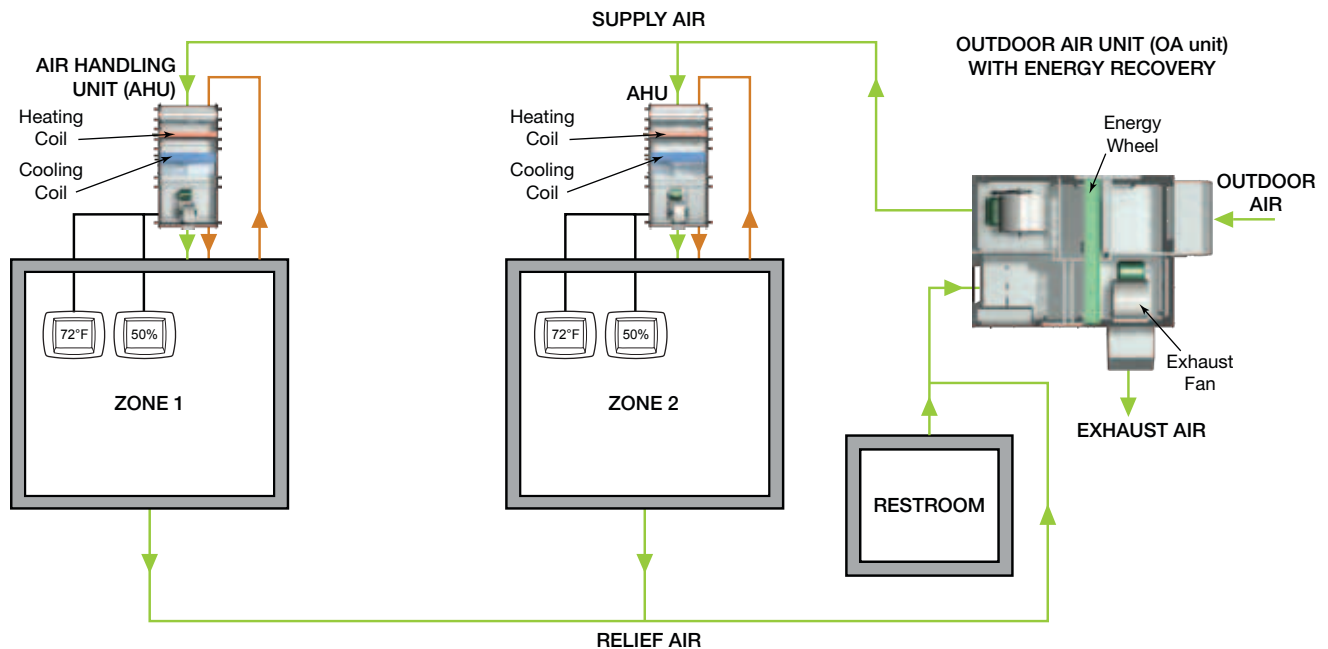

With Packaged Rooftop Equipment

This diagram illustrates how energy recovery ventilators may be used in conjunction with packaged rooftop equipment. Fresh, outdoor air enters the energy recovery ventilator and is pretreated before entering the heating/cooling equipment. This pretreating occurs because the energy recovery wheel is transferring latent and sensible energy between the outdoor air and the building exhaust air.

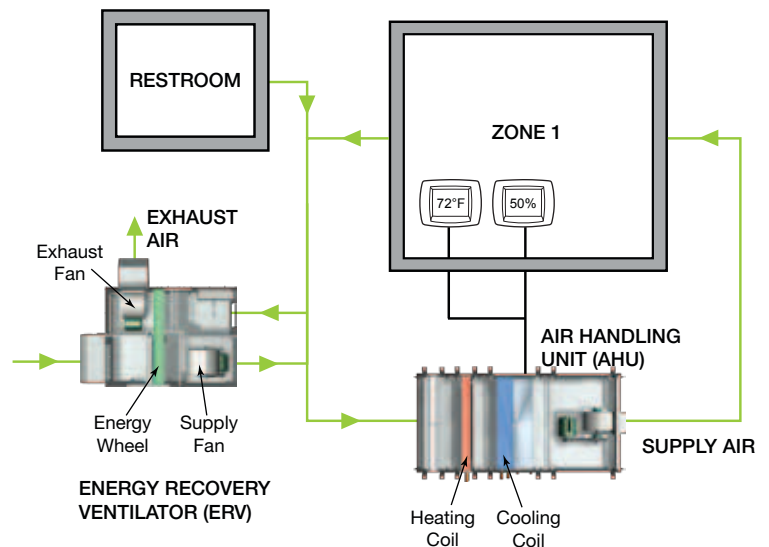

Greenheck's Energy Recovery Models

Model MiniVent - Energy Recovery Ventilator

The MiniVent-450 & 750 are energy recovery ventilators used for commercial and institutional applications that require 300 to 800 cfm of ventilation air. The compact design provides an economical solution for individual spaces, such as school classrooms and small offices.

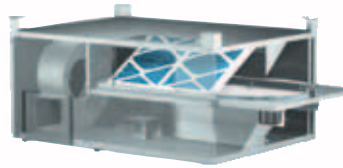

Model ERH - Energy Recovery with Heating

With the ERH, you save money with the total energy wheel and get the convenience of supplemental heating. The ERH provides preconditioned air in the summer and space neutral air in the winter, which is ideal if your climate has prominent summer and winter seasons. The heating section further tempers cold outdoor air to desired conditions. Four housing sizes available with airflow capacities up to 10,000 cfm and external static pressures up to 1.5 in. wg.

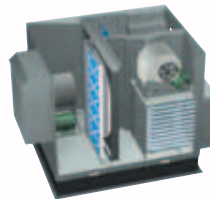

Model ERCH - Energy Recovery with Cooling and Heating

The model ERCH combines the benefits of the total energy wheel with supplemental cooling and heating. The result is a product that is specifically designed to process 100% outdoor air to desired supply conditions. Four housing sizes provide airflow capacities from 1,000 to 10,000 cfm with external static pressures up to 1.5 in. wg. A variety of tempering options are available. The coil section of the ERCH accommodates a cooling coil, a heating coil, or both.

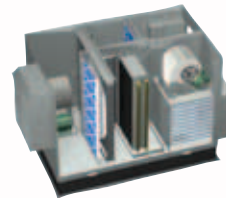

Model VER - Versatile Energy Recovery (VersiVent)

The Model VER is a fully featured, versatile energy recovery unit with a wide range heating and cooling options available. The unit includes an energy wheel to pre temper the outdoor air which reduces the heating and cooling equipment needed, while also lowering operational costs. In addition to the standard heating and cooling options, the VersiVent has options such as environmentally friendly R410 refrigerant, a wrap-around heat pipe for additional dehumidification and reheat capacity, and a quiet, efficient, plenum supply fan. Capacities range from 2,000 to 10,000 cfm with external static pressures up to 3.0 in. wg.

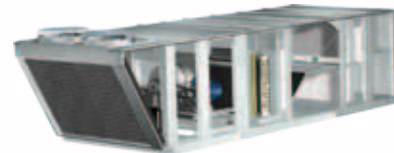

Model APEX - Affordable, Practical, Energy Exchanger

The model APEX combines high airflow capacities with cost saving energy recovery ventilation by providing centralized outdoor air distribution and reducing the need for multiple unit installations. Fresh outdoor air is preconditioned by the total enthalpy wheel, which recovers a majority of the energy from the exhaust air. It saves 3-4 tons of cooling per 1,000 cfm and saves 50-60 MBH of heating per 1,000 cfm. Easy to install and operate with airflow capacities from 10,000 to 20,000 cfm and external static pressures up to 2.5 in. wg.

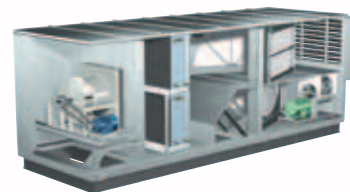

Our Warranty

Greenheck warrants this equipment to be free from defects in material and workmanship for a period of one year from the shipment date. The energy recovery wheel is warranted to be free from defects in material and workmanship for a period of five years from the shipment date. Any units or parts which prove defective during the warranty period will be replaced at our option when returned to our factory, transportation prepaid. Motors are warranted by the motor manufacturer for a period of one year. Should motors furnished by Greenheck prove defective during this period, they should be returned to the nearest authorized motor service station. Greenheck will not be responsible for any removal or installation costs.

As a result of our commitment to continuous improvement, Greenheck reserves the right to change specifications without notice.



Prepared to Support
Green Building Efforts

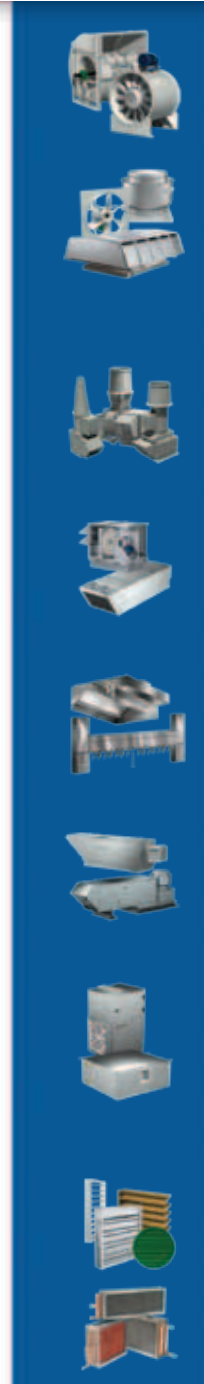

Free Manuals Download Website

<http://myh66.com>

<http://usermanuals.us>

<http://www.somanuals.com>

<http://www.4manuals.cc>

<http://www.manual-lib.com>

<http://www.404manual.com>

<http://www.luxmanual.com>

<http://aubethermostatmanual.com>

Golf course search by state

<http://golfingnear.com>

Email search by domain

<http://emailbydomain.com>

Auto manuals search

<http://auto.somanuals.com>

TV manuals search

<http://tv.somanuals.com>