

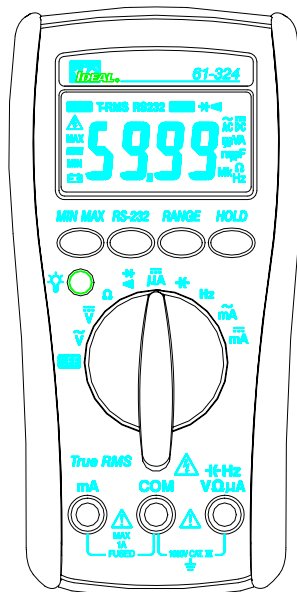

IDEAL INDUSTRIES, INC.
TECHNICAL MANUAL
MODEL: 61-320
MODEL: 61-322
MODEL: 61-324

The Service Information provides the following information:

- Precautions and safety information
- Specifications
- Performance test procedure
- Calibration and calibration adjustment procedure
- Basic maintenance (cleaning, replacing the battery and fuses)



Form Number: TM61320-2-4
Revision: 2. Date: Sep 2002

TABLE OF CONTENTS

	Page #
Introduction	1
Precautions and Safety Information	1
Symbols	1
Safety	2
Specifications	3
General Specification	3
Voltage Specifications	4
Current Specifications	5
Resistance, Diode, Continuity Specifications	5
Capacitance, Frequency Specifications	6
Physical and environment characteristics	7
Certification and compliance	7
Required Equipment	8
Basic Maintenance	9
Opening the Meter Case	9
Replacing the Battery	9
Testing Fuses	10
Replacing Fuses	10
Cleaning	10
Performance Tests	11
Testing the Display	11
Testing the Voltage Function	11/12
Testing the Resistance Function	12
Testing the Capacitance Function	13
Testing the Diode	13
Testing the Milliamp (mA) Function	13
Testing the microamp Function	14
Testing the Frequency Function	14/15
Calibration	15
Calibrating DCV, ACV Functions	15
Calibration Adjustment Points	16

Introduction** Warning**

To avoid shock or injury, do not perform the verification tests or calibration procedures described in this manual unless you are qualified to do so.

The information provided in this document is for the use of qualified personnel only.

 Caution

The 61-320, 61-322, and 61-324 contain parts that can be damaged by static discharge. Follow the standard practices for handling static sensitive devices.

For additional information about IDEAL INDUSTRIES, INC. and its products, and services, visit IDEAL INDUSTRIES, INC. web site at:

www.idealindustries.com









Precautions and Safety Information

Use the meter only as described in the *Users Manual*. If you do not do so, the protection provided by the meter may be impaired. Read the "Safety Information" page before servicing this product. In this manual, a **Warning** identifies conditions and actions that pose hazard(s) to the user; a **Caution** identifies conditions and actions that may damage the meter or the test instruments.

The Symbols

The symbols used on the meter and in this manual are explained in Table A.

Table A. The Symbols

Symbol	Meaning	Symbol	Meaning
	Alternating signal		Battery
	Direct signal		Earth ground
CAT III	IEC over voltage Category III		Fuse
	Refer to the manual. Important information.		Double insulated
	Take appropriate precautions. Hazardous voltage may be present		

SAFETY

Review the following safety precautions to avoid injury and prevent damage to this product or any products connected to it. To avoid potential hazards, use the product only as specified.

⚠CAUTION. These statements identify conditions or practices that could result in damage to the equipment or other property.

⚠WARNING. These statements identify conditions or practices that could result in personal injury or loss of life.

Specific precautions

Use proper Fuse. To avoid fire hazard, use only the fuse type and rating specified for this product.

Do not operate without covers. To avoid personal injury, do not apply any voltage or current to the product without the covers in place.

Electric overload. Never apply a voltage to a connector on the product that is outside the range specified for that connector.

Avoid electric shock. To avoid injury or loss of life, do not connect or disconnect probes or test leads while they are connected to a voltage source.



Do not operate in wet/damp conditions. To avoid electric shock, do not operate this product in wet or damp conditions.

SPECIFICATIONS

All specifications are warranted unless noted typical and apply to the 61-320, 61-322 and 61-324.

Stated accuracies are at 23°C ± 5°C at less than 80% relative humidity and without the battery indicator displayed.

General specifications

Characteristics	Description
Display count	6,000
Numeric update rate	1.5 times / sec
Polarity display	Automatic
Overrange display	“OL” is displayed
Low voltage indicator	 is indicated
Automatic power-off time	Automatic backlight off = 10 minutes
Power source	1.5 x 2 IEC LR03 or AAA size for 61-320 One 9V dry cell battery for 61-322 and 61-324
Maximum input voltage	1000V CAT III between V and COM
Maximum floating voltage	1000V CAT III between any terminal and earth ground
Maximum input current	600mA between mA and COM
Maximum open circuit Voltage (current inputs)	600V between mA and COM
Overload protection mA connector	1A (600V) fast blow fuse
V connector	1100 Vp V \sim , V $\overline{\sim}$, Ω , μ),  ,  , Hz, μ A
Temperature Coefficient	0.15 x (Spec. Accuracy) / °C, <18°C or >28°C
Battery Life	300 hours typical (alkaline)

Measurement Characteristics

Accuracy is \pm (% reading + number of digits) at $23^{\circ}\text{C} \pm 5^{\circ}\text{C}$, less than 80% R.H.

DC Volts

Range	Resolution	Accuracy	Over voltage protection
600.0mV	100 μ V	$\pm(0.5\% + 2\text{dgt})$	1000V rms
6.000V	1mV		
60.00V	10mV		
600.0V	100mV		
1000V	1V		

AC Volts

Range	Resolution	Accuracy	Over voltage protection
600.0mV	100 μ V	Unspecified	1000V rms
6.000V	1mV	$\pm(0.9\% + 5\text{dgt})$ 50Hz ~ 500Hz *	
60.00V	10mV		
600.0V	100mV		
750V	1V		

Input Impedance: 10M Ω // less than 100pF.

**CMRR / NMRR: (Common Mode Rejection Ratio)
(Normal Mode Rejection Ratio)**

V_{AC} : CMRR > 60dB at DC, 50Hz / 60Hz

V_{DC} : CMRR > 100dB at DC, 50Hz / 60Hz

NMRR > 50dB at DC, 50Hz / 60Hz

AC Conversion Type: 61-320: Average sensing rms indication.

61-322 / 61-324: AC conversions are ac-coupled, true rms responding, calibrated to the sine wave input.

* The basic accuracy is specified for sine wave below 4000 counts. Over 4000 counts, need to add 0.6% to the accuracy for non-sine waves below 2000 counts, refer to the following for accuracy:

Crest Factor (C.F.):

+1.5% addition error for C.F. from 1.4 to 3

+3.0% addition error for C.F. from 3 to 4 where C.F.=Peak / RMS

DC Current

Range	Resolution	Accuracy	Over voltage protection
600.0 μ A	1mV	$\pm(1.0\%+2 \text{ dgt})$	600V rms 1A (600) Fast blow fuse
6000 μ A	1mV		
60.00mA	10mV		
600.0mA	100mV		

AC Current

Range	Resolution	Accuracy	Over voltage protection
600.0 μ A	1mV	$\pm(1.5\%+2 \text{ dgt})$ 50Hz ~ 500Hz *	600V rms 1A (600) Fast blow fuse
6000 μ A	1mV		
60.00mA	10mV		
600.0mA	100mV		

Voltage Burden: μ A: $<4\text{mV} / \mu\text{A}$
mA: 2V max.

* **AC Conversion Type:** Conversion type and additional specification are same as DC/AC Voltage.

Resistance

Range	Accuracy	Overload protection
600.0 Ω	$\pm(0.7\%+2 \text{ dgt})$	600V rms
6.000K Ω		
60.00K Ω		
600.0K Ω		
6.000M Ω	$\pm(1.0\%+2 \text{ dgt})$	
60.00M Ω *	$\pm(1.5\%+2 \text{ dgt})$	

Open circuit Voltage: -1.3V approx.

* $< 2\%$ of reading rolling.

Diode Check and Continuity

Range	Resolution	Accuracy	Overload protection
	10 mV	$\pm(1.5\% + 5 \text{ dgt})^*$	600V rms

* For 0.4V ~ 0.8V

Max. Test Current: 1.5mA

Max. Open Circuit Voltage: 3V

Continuity: Built-in buzzer sounds when resistance is less than approximately 100 Ω . Response time is approximately 100 msec.

Frequency

Range	Sensitivity	Accuracy	Overload protection
6000Hz	100mV rms *	Frequency : 0.01%±1digit	600V rms
60.00KHz			
600.0KHz			
6.000MHz	250mV rms		
60.00MHz	1V rms		

* Less than 20Hz, the sensitivity is 1.5V rms.

Capacitance

Range	Accuracy	Overload protection
6.000nF	±(1.9% + 8 dgt)	600V rms
60.00nF		
600.0nF		
6.000µF		
60.00µF		
600.0µF		
6.000mF *		

* < 100 dgt of reading rolling.

Physical and Environmental Characteristics

Characteristics	Description
Dimensions (H x W x D)	158mm x 76mm x 38mm 164mm x 82mm x 44mm (with holster)
Weight (with battery)	0.3Kg
With holster	0.5Kg
Environmental Characteristics	Description
Temperature operating	0 to + 50°C
Non-Operating	-20 to + 60°C
Humidity (operating)	< 80% R.H.
Altitude Operating	2,000 m (6560 ft.)
Non-Operating	12,300 m (40354 ft.)
Vibration & shock Operating	MIL-T-28800E TYPE II Class 5 2.66gRMS, 5 to 500 Hz, 3axes (10 minutes each)
Indoor Use	Indoor Use

Certifications and compliances

Safety	Designed to IEC 1010-1, UL3111-1 and CSA specifications
Input rating	V / Ω / μ A: Category III 1000 Volts mA: Category III 600 Volts
Over voltage category	CAT III: Distribution level mains, fixed installation. CAT II: Local level mains, appliances, portable equipment. CAT I: Signal level, special equipment or parts of equipment, telecommunication, electronics.
Pollution Degree 2	Do not operate in environments where conductive Pollutants may be present.
EC Declaration of Conformity	Meets the intent of Directive 89/336/EEC for Electromagnetic Compatibility and Low Voltage Directive 73/23/EEC for Product Safety. Compliance was demonstrated to the following specifications as listed in the official Journal of the European Communities: En 55011 Class A: Radiated and Conducted Emissions. EN 50082-1 Immunity: IEC 801-2 Electrostatic Discharge IEC 801-3 RF Radiated EN 61010-1 Safety requirements for electrical equipment for measurement, control, and laboratory use.

Required Equipment

Required equipment is listed in Table B. If the recommended models are not available, equipment with equivalent specifications may be used.

Repairs or servicing should be performed only by qualified personnel.

Table B. Required Equipment

Equipment	Required Characteristics	Recommended Model
Calibrator	<p>AC Voltage Range: 0-750 VAC Accuracy: ±0.07% (Basic) Frequency Range: 40 ~ 1KHz Accuracy: ±2%</p> <p>DC Voltage Range: 0-1000V DC Accuracy: ±0.006% (Basic)</p> <p>Current Range: 0 ~ 10A Accuracy: AC (40Hz to 1KHz): ±0.08% (Basic) DC: ±0.02% (Basic)</p> <p>Frequency Source: 5.00Hz ~ 100MHz Accuracy: ±0.001%</p> <p>Amplitude: 0.5V p-p ~ 1.0V p-p (square wave) Accuracy: ±5%</p> <p>Resistance range: 1Ω ~ 100M Ω Accuracy: ±0.03% (Basic)</p> <p>Capacitance Range: 1PF ~ 10mF Accuracy: ±0.10% (Basic)</p>	Fluke 5500 or Wavetek 9100 Calibrator or equivalent

Basic Maintenance

Warning

To avoid shock, remove the test leads and any input signals before opening the case or replacing the battery or fuses.

Opening the Meter Case

Caution

To avoid unintentional short circuit, always place the uncovered meter assembly on a protective surface. When the case of the meter is open, circuit connections are exposed.

To open the meter case, refer to Figure 1A and do the following:

1. Disconnect test leads from any live source, turn the rotary switch to OFF, and remove the test leads from the front terminals.
2. Remove the battery door by using a screwdriver to turn the battery door screws counter-clockwise.
3. The case bottom is secured to the case top by four screws and two internal snaps (at the LCD end). Using a screwdriver, remove the four screws.

Replacing the Battery

The meter is powered by 1.5V x 2 batteries for 61-320 and a single 9V battery for 61-322 and 61-324. To replace the battery, refer to Figure 1A.

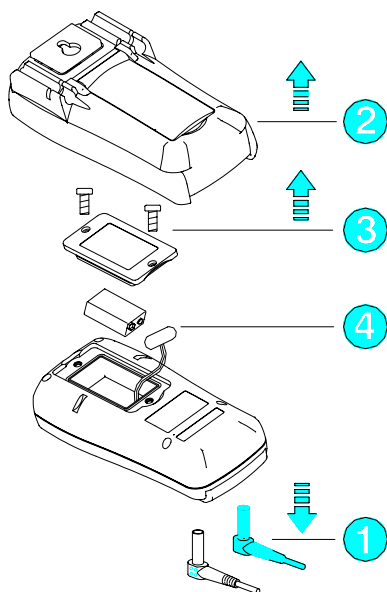

Figure 1A

Testing Fuses

To test the internal fuses of the meter:

1. Turn the rotary selector switch to the Ω position.
2. To test FS1, plug a test lead into V Ω Hz input terminal and touch the probe to the mA input terminal. The display should indicate between 0.0 to 0.2 Ω . FS1 (1A 600V - Bussmann BBS-1 recommended). If display reads higher than 0.2 Ω , replace the fuse.

Fuse Replacement

Refer to Figure 1B to replace the fuse:

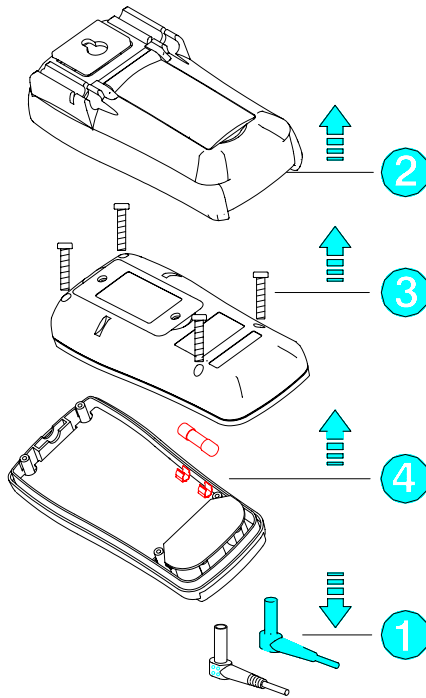

Figure 1B

Use only a fuse with the amperage, interrupt, voltage, and speed rating specified.
Fuse rating: 1A, 600V, Fast

Replacing Fuses

Warning

To avoid electrical shock, remove the test leads and any input signals before replacing the battery or fuses. To prevent damage or injury, **INSTALL ONLY** quick acting fuses with the following Amp/Volt current interrupt rating:
FS1 Fuse: 1A, 600V, FAST. Minimum interrupt rating: 10,000A.

Cleaning

Warning

To avoid electrical shock or damage to the meter, never allow water inside the case. To avoid damaging the meter's housing, never apply solvents to the meter.

Performance Tests

The following performance tests verify the complete operability of the meter and check the accuracy of each meter function against the meter's specifications.

Accuracy specifications are valid for a period of one year after calibration, when measured at an operating temperature of 18°C to 28°C and at a maximum of 80% relative humidity.

To perform the following tests, it is not necessary to open the case; no adjustments are necessary. Merely make the required connections, apply the designated inputs, and determine if the reading on the meter display falls within the acceptable range indicated.

If the meter fails any of these tests, it needs calibration adjustment or repair.

Testing the Display

Press "HOLD" key while turning the meter on from the "OFF" position to hold the display in the Display Test Mode. Compare the display with the example in Figure 2. Turn off the meter to escape the test mode.

LCD Graphics 61-324

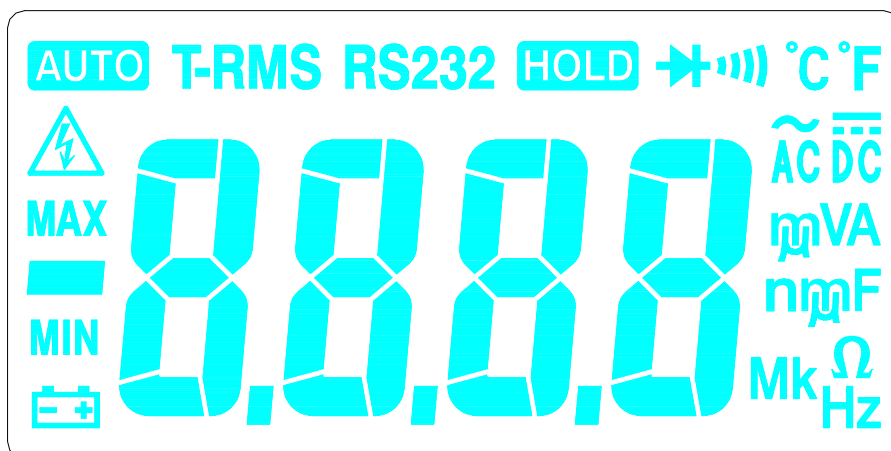

Figure 2 Display Test

Testing the Voltage Function

To verify accuracy in the AC and DC voltage ranges, do the following:

1. Turn the rotary switch to "V~" position.
2. Connect the calibrator to the **VΩ** and **COM** inputs on the meter.
3. Set the calibrator for the voltage and frequency from step 1 to 8 in Table 1.
4. Compare the reading on the meter display with the display reading shown in Table 1.
5. *If the display reading falls outside of the range shown in Table 1, the meter does not meet specification.*

Table 1 AC Voltage Test:

Step	Input	Frequency	Reading
1	5.800V	50Hz	5.743 to 5.857
2	5.800V	500Hz	5.743 to 5.857
3	58.00V	50Hz	57.43 to 58.57
4	58.00V	500Hz	57.43 to 58.57
5	580.0V	50Hz	574.3 to 585.7
6	580.0V	500Hz	574.3 to 585.7
7	750V	50Hz	738 to 762
8	750V	500Hz	738 to 762

6. Turn the rotary switch to “V $\overline{\text{---}}$ ” position.
7. Set the calibrator for the voltage from step 1 to 6 in Table 2.
8. Compare the reading on the meter display with the display reading shown in Table 2.
9. *If the display reading falls outside of the range shown in Table 2, the meter does not meet specification.*

Table 2 DC Voltage Test:

Step	Input	Reading
1	580.0mV	576.9 to 583.1
2	-580.0mV	-576.9 to -583.1
3	5.800V	5.769 to 5.831
4	58.00V	57.69 to 58.31
5	580.0V	576.9 to 583.1
6	900V	894 to 906

Testing the Resistance Function

To verify the accuracy of the resistance function, do the following:

1. Connect the calibrator to **V Ω Hz** and **COM** on the meter.
2. Turn the rotary switch to Ω .
3. Apply the inputs for step 1-6 in Table 3.
4. Compare the meter display readings to the display readings in Table 3.
5. *If the display reading falls outside of the range shown in Table 3, the meter does not meet specification.*

Table 3 Ω Resistance Test:

Step	Source	Reading
1	580.0 Ω	575.7 to 584.3
2	5.800K Ω	5.757 to 5.843
3	58.00K Ω	57.57 to 58.43
4	580.0K Ω	575.7 to 584.3
5	5.800M Ω	5.740 to 5.860
6	58.00M Ω	57.11 to 58.59

* Lead resistance on the 400 Ω range is not included in error.

Testing the Capacitance Function

The meter measures capacitance by charging the capacitor with a known direct current, measuring the resultant voltage, and calculating the capacitance. If the same capacitance is measured on an impedance bridge, a different reading may result. This variance is likely to be greater at higher frequencies.

To verify the accuracy of the capacitance measuring function, do the following:

1. Apply the capacitor to the **VΩHz** and **COM** inputs on the meter for steps 1 through 7 in Table 4.
2. Turn the rotary switch to **←**.
3. Compare the reading on the meter display to the reading in Table 4.
Note: The meter selects the proper range automatically. Each measurement takes about one second per range, 5mF takes about 4.5 seconds.
4. *If the display reading falls outside of the range shown in Table 4, the meter does not meet specification.*

Table 4 Capacitance Test:

Step	Source	Reading
1	5.800nF	5.682 to 5.912
2	58.00nF	56.82 to 59.12
3	580.0nF	568.2 to 591.2
4	5.800μF	5.682 to 5.912
5	58.00μF	56.82 to 59.12
6	580.0μF	568.2 to 591.2
7	5.800mF	5.682 to 5.912

Checking the Diode Test Function

To check the diode test function, do the following:

1. Connect the calibrator to the **VΩHz** and **COM** inputs on the meter.
2. Turn the rotary switch to **→**.
3. Apply 0.500V DC.
The meter display should read approx. 0.500V dc.
4. Apply a 50Ω resistor to the meter, the built-in beeper alarms.

Testing the Milliamp (mA) Function (for 61-322 and 61-324)

To verify the accuracy of AC current measurement functions, do the following:

1. Connect the calibrator to the **mA** and **COM** inputs on the meter.
2. Turn the rotary switch to **~**.
3. Apply the inputs for steps 1-4 in Table 5.
4. For each input, compare the readings on the meter display to the reading in Table 5.
5. *If the display reading falls outside of the range shown in the Table 5, the meter does not meet specification.*

Table 5 AC mA Test:

Step	Source	Frequency	Reading
1	58.00mA	50Hz	56.93 to 59.07
2	58.00mA	500Hz	56.93 to 59.07
3	580.0mA	50Hz	569.3 to 590.7
4	580.0mA	500Hz	569.3 to 590.7

6. Turn the rotary switch to mA $\overline{\text{---}}$.
7. Apply the inputs for steps 1-2 in Table 6.
8. For each input, compare the reading on the meter display to the reading in Table 6.
9. *If the display reading falls outside of the range shown in Table 6, the meter does not meet specification.*

Table 6 DC Current Test:

Step	Source	Reading
1	58.00mA	57.40 to 58.60
2	580.0mA	574.0 to 586.0

Testing the microamp Function

1. Turn the rotary switch to $\mu\text{A}\overline{\text{---}}$.
2. Apply the inputs for steps 1-2 in Table 7.
3. For each input, compare the reading on the meter display to the reading for your meter in Table 7.
4. *If the display reading falls outside of the range shown in Table 7, the meter does not meet specification.*

Table 7 DC μA Test:

Step	Source	Reading
1	580 μA	574.0 to 586.0
2	5800 μA	5740 to 5860

Testing the Frequency Function

To verify the accuracy of the meter's frequency function, do the following:

1. Connect the calibrator to the **V Ω** and **COM** inputs on the meter.
 - Note:* The accuracy of the calibrator's frequency function must be appropriate for the specified accuracy of the meter.
2. Set the rotary switch to Hz.
3. Set the function generator for the square wave voltage and frequency for steps 1-5 of Table 8.
4. Compare the reading on the meter display with the display reading shown in Table 8.
5. *If the display reading falls outside of the range shown in Table 8, the meter does not meet specification.*

Table 8 Frequency Test:

Step	Source	Level	Reading
1	5.600KHz	100mV rms	5.598 to 5.602
2	56.00KHz	100mV rms	55.98 to 56.02
3	560.0KHz	100mV rms	559.8 to 56.02
4	5.600MHz	250mV rms	5.598 to 5.602
5	56.00MHz	1V rms	55.98 to 56.02

Calibration

Calibrate the meter once a year to ensure that it performs according to specifications.
Perform calibration at an ambient temperature of 23°C ±2°C and relative humidity of 75% or less

Calibration for the Model 61-320, 61-322 and 61-324:

1. Disconnect the test leads and turn the meter off. Remove the test leads from the front terminals.
2. Position the meter face down. Remove the screws from the case bottom.
3. Lift the end of the case bottom until it gently unsnaps from the case top at the end nearest the LCD.
4. Loosen the screws that hold the circuit board in place and gently lift the board to access the calibration pots.

DO NOT REMOVE THE SCREWS.

(A) DCV Calibration (Adjust VR1 – Figure 3)

5. Set the circuit board rotary switch “arrow” to the “V $\overline{\text{---}}$ ” position of circuit board.
6. Set the output of DC calibrator for 300.0V ±0.02% and connect to V Ω Hz and COM input terminals on the meter.
7. Using a small flat-tipped screw driver, adjust the potentiometer VR1 until the display reads 300.0 or 299.9
8. Disconnect the DC calibrator from the meter.

(B) ACV Calibration (Adjust VR2 – Figure 3)

9. Set the circuit board rotary switch “arrow” to the “V \sim ” position of circuit board.
10. Set the output of AC calibration for 300V 50Hz and connect to V Ω Hz and COM input terminals on the meter.
11. Using a small flat-tipped screw driver, adjust the potentiometer VR2 until the display reads 300.0 or 299.9
12. Disconnect the AC calibrator from the meter.

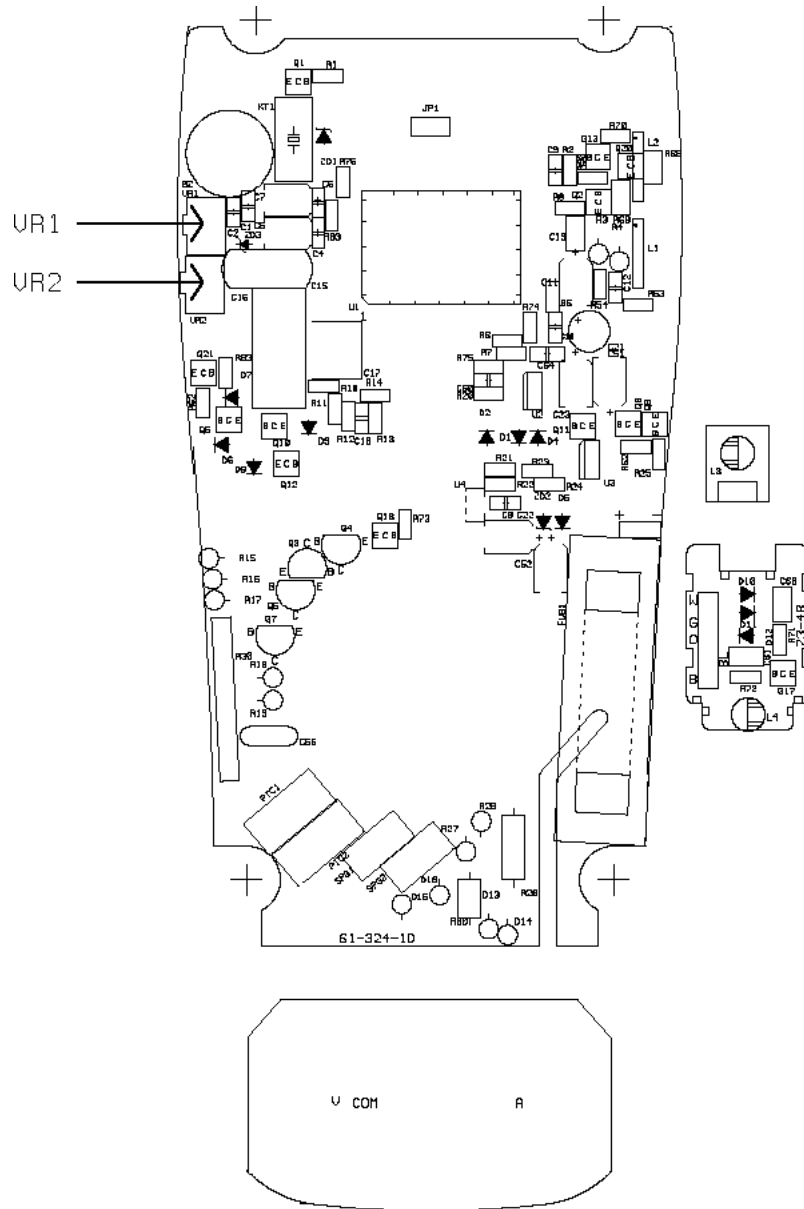

Figure 3 - Calibration Adjustment Points

Free Manuals Download Website

<http://myh66.com>

<http://usermanuals.us>

<http://www.somanuals.com>

<http://www.4manuals.cc>

<http://www.manual-lib.com>

<http://www.404manual.com>

<http://www.luxmanual.com>

<http://aubethermostatmanual.com>

Golf course search by state

<http://golfingnear.com>

Email search by domain

<http://emailbydomain.com>

Auto manuals search

<http://auto.somanuals.com>

TV manuals search

<http://tv.somanuals.com>