



INSTRUCTION MANUAL

UHF C.R.S. TRANSCEIVER
IC-40S

Icom Inc.

Download from www.Somanuals.com. All Manuals Search And Download.

FOREWORD

READ ALL INSTRUCTIONS carefully and completely before using the transceiver.

SAVE THIS INSTRUCTION MANUAL — This instruction manual contains important operating instructions for the IC-40S.

EXPLICIT DEFINITIONS

The explicit definitions below apply to this instruction manual.

WORD	DEFINITION
 WARNING	Personal injury, fire hazard or electric shock may occur.
CAUTION	Equipment damage may occur.
NOTE	If disregarded, inconvenience only. No risk of personal injury, fire or electric shock.



N33

This device complies with Standards Australia Specification no. AS/NZS4365-1995 & AS4295-1995.

CAUTIONS

 **WARNING! NEVER** hold the transceiver so that the antenna is very close to, or touching exposed parts of the body, especially the face or eyes, while transmitting. The transceiver will perform best if the microphone is 5 to 10 cm away from the lips and the transceiver is vertical.

 **WARNING! NEVER** operate the transceiver with a headset or other audio accessories at high volume levels. Hearing experts advise against continuous high volume operation. If you experience a ringing in your ears, reduce the volume level or discontinue use.

NEVER connect the transceiver to an AC outlet or to a power source of more than 16 V DC. Such a connection will damage the transceiver.

NEVER connect the transceiver to a power source that is DC fused at more than 5 A. Accidental reverse connection will be protected by this fuse, higher fuse values will not give any protection against such accidents and the transceiver will be ruined.

NEVER attempt to charge alkaline or dry cell batteries. Be aware that external DC power connections will charge batteries inside the battery case. This will damage not only the battery case but also the transceiver.

SUPPLIED ACCESSORIES

DO NOT push the PTT when not actually desiring to transmit.

DO NOT allow children to play with any radio equipment containing a transmitter.

DO NOT operate the transceiver near unshielded electrical blasting caps or in an explosive atmosphere.

AVOID using or placing the transceiver in direct sunlight or in areas with temperatures below -10°C or above $+60^{\circ}\text{C}$.

The use of non-Icom battery packs/chargers may impair transceiver performance and invalidate the warranty.

Even when the transceiver power is OFF, a slight current still flows in the circuits. Remove the battery pack or case from the transceiver when not using it for a long time. Otherwise, the battery pack or installed dry cell batteries will become exhausted.

Accessories included with the transceiver:	Qty.
① Antenna	1
② Belt clip	1
③ Battery pack attached to the transceiver*	1
④ Wall charger*	1
⑤ 1922A REAR-SHEET (for dealer use)	1

*The battery pack (BP-195 or BP-196) may differ depending on version. Some versions do not include a battery pack and wall charger.

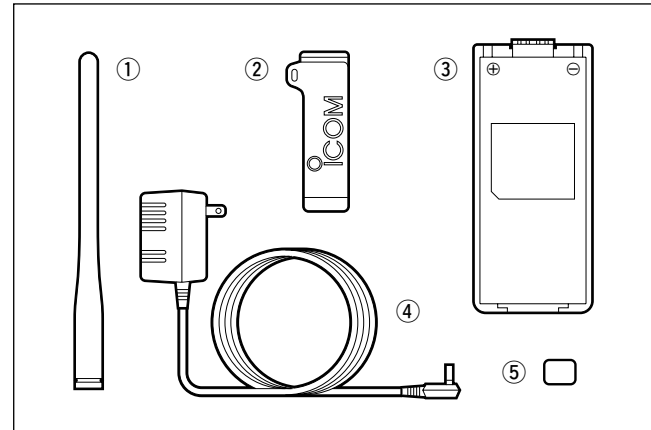

TABLE OF CONTENTS

FOREWORD	i	5 TONE SQUELCH OPERATION	11
EXPLICIT DEFINITIONS	i	■ Tone squelch operation	11
CAUTIONS	i	■ Pocket beep operation	11
SUPPLIED ACCESSORIES.....	ii	6 BATTERY PACKS	12–14
TABLE OF CONTENTS	iii	■ Charging precautions	12
1 ACCESSORY ATTACHMENT	1	■ Battery pack charging	12
2 PANEL DESCRIPTION	2–4	■ About the battery pack	14
■ Panel description	2	■ Installing batteries in the battery case	14
■ Function display	4	7 OTHER FUNCTIONS	15–16
3 BASIC OPERATION	5–7	■ Time-out timer	15
■ Receiving and transmitting	5	■ Power saver	15
■ Display backlighting	6	■ Confirmation beeps	15
■ Lock function	6	■ Transmit lockout	16
■ Monitor function	6	■ Optional HM-75A functions	16
■ Repeater operation	7	8 TROUBLESHOOTING	17
4 SCAN OPERATION	8–10	9 SPECIFICATIONS	18
■ Scan types	8	10 OPTIONS	19
■ Open scan	8		
■ Group and priority scans	9		
■ Setting scan tag	9		
■ Scan resume condition	10		

ACCESSORY ATTACHMENT

1

◇ Antenna

CAUTION: Transmitting without an antenna may damage the transceiver.

Insert the supplied antenna into the antenna connector and screw down the antenna as shown at right.

Keep the jack cover attached when jacks are not in use to avoid bad contacts from dust and moisture.

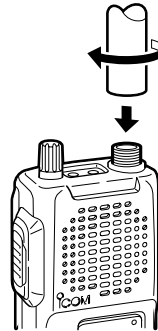

◇ Belt clip

Conveniently attaches to your belt.

To attach:

Slide the belt clip into the plastic loop on the back of the battery case/pack.

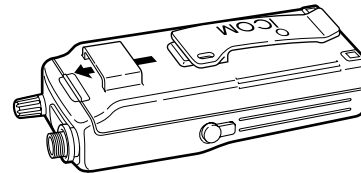

To remove:

Push the top of the belt clip towards the transceiver and at the same time, push it downward and free of the plastic loop.

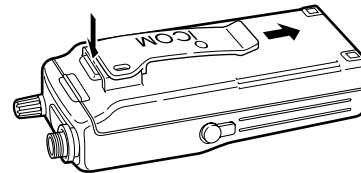

◇ Battery pack replacement

To remove:

Push and hold the battery release downwards, then pull the battery pack upwards as shown at right.

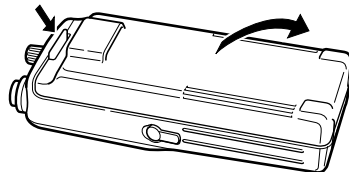

To attach:

Mate the notched ends of the battery pack and the transceiver, and push the battery pack until it clicks into place.

■ Panel description

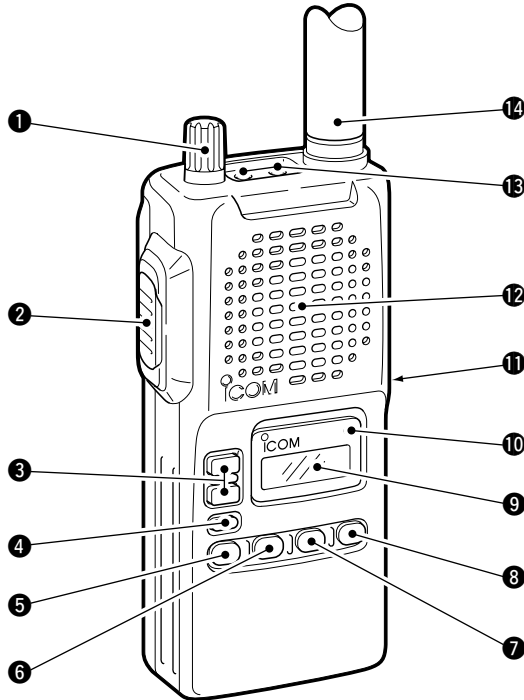

- ❶ VOLUME CONTROLS [VOL]** (p. 5)
Turns power ON and adjusts the audio level.
- ❷ PTT SWITCH [PTT]** (p. 5)
Push and hold to transmit; release to receive.
- ❸ CHANNEL UP/DOWN SWITCHES [▲]/[▼]**
 ➤ Push to select the operating channel. (p. 5)
 ➤ Select item conditions in set mode.
- ❹ MONITOR SWITCH [-]**
 ➤ Push to toggle the monitor function ON or OFF. (p. 6)
 ➤ Activates the following functions in order when pushed for 2 sec. (p. 11)

 - Subaudible tone encoder—"T" appears.
 - Tone squelch—"T SQL" appears.
 - Pocket beep—"T SQL 📞" appears.
 - No tone operation—no indicator appears.
- ❺ SCAN SWITCH [SCN]**
 ➤ Starts and stops the selected scan when pushed. (p. 8)
 ➤ Toggles the displayed channel to be scanned or bypassed by the selected scan when pushed for 2 sec. (p. 9)

 - "MR" appears for a scan (tag) channel.

6 SCAN TYPE SELECTION SWITCH [O/G]

- ➔ Push to select the scan types in order. (p. 8)
 - Open scan—"OS" appears.
 - Group scan—"GS" appears.
 - Priority scan—"PS" appears.
- ➔ When the group or priority scan is selected, this switch sets the displayed channel as the priority channel for the selected scan when pushed for 2 sec. (p. 9)
 - While the priority channel is set, the priority channel is displayed at the right of the operating channel.

7 OUTPUT POWER SWITCH [LOW]

- ➔ Push this switch to toggle between high and low output power. (p. 5)
- ➔ Enters set mode when pushed for 2 sec.
- ➔ Scrolls the set mode contents while in the set mode.

8 DUPLEX SWITCH [DUP]

- ➔ Toggles the selected channel between duplex or simplex operation on channels 1 to 8. (p. 7)
- ➔ Toggles the lock function ON and OFF when pushed for 2 sec. (p. 6)
 - "  " appears when the lock function is activated.

9 FUNCTION DISPLAY (p. 4)

10 TRANSMIT INDICATOR (p. 5)

Lights red while transmitting.

11 EXTERNAL DC POWER JACK [CHARGE]

Connect a 12 to 16 V DC power source using the optional cables, CP-12L or OPC-254L, to charge the attached battery pack; or connect the BC-110V wall charger for charging.

 **CAUTION:** This connection is for charging ONLY. Power to the transceiver must be turned OFF during charging.

12 SPEAKER/MICROPHONE

13 EXTERNAL SPEAKER AND MICROPHONE JACKS [SP/MIC]

Connect an optional speaker-microphone or headset, if desired. The internal microphone and speaker will not function when either is connected. (See p. 19 for a list of available options.)

14 ANTENNA CONNECTOR (p. 1)

Connects the supplied antenna.

2 PANEL DESCRIPTION

■ Function display

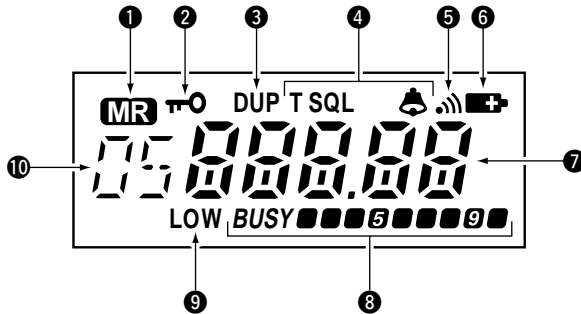

1 TAG CHANNEL INDICATOR (p. 9)

Appears when the selected channel is set as a tag channel.

- Tag channels can be set separately for each scan type.

2 LOCK INDICATOR (p. 6)

Indicates that the lock function is in use.

3 DUPLEX INDICATOR (p. 7)

Appears when semi-duplex operation (repeater operation) is in use.

- “DUP” appears when duplex is selected.
- This function is available for channels 1 to 8 only.

4 TONE INDICATORS (p. 11)

“T” appears when the subaudible tone encoder is in use; “T SQL” appears when the tone squelch function is activated and “T SQL ” appears during pocket beep operation.

5 MONITOR INDICATOR (p. 6)

Appears when the monitor function is turned ON (the squelch opens).

6 LOW BATTERY INDICATOR

- ➔ Appears when the battery is nearing exhaustion.
- ➔ Appears and flashes when battery replacement is necessary.

7 CHANNEL READOUT

Shows the operating channel, priority channel, set mode contents, etc.

8 BUSY AND SIGNAL INDICATORS

- ➔ “BUSY” appears when receiving a signal or when the squelch is open.
- ➔ The signal indicators show the relative signal strength while receiving.

9 LOW POWER INDICATOR (p. 5)

Appears when low output power is selected.

10 SCAN TYPE INDICATOR (p. 8)

Shows the selected scan type: open scan (OS), group scan (GS) or priority scan (PS).

■ Receiving and transmitting

CAUTION: Transmitting without an antenna may damage the transceiver.

- ① Rotate [VOL] clockwise to turn power ON, then set to the 10 o'clock position.
 - If "T SQL" appears on the display, push [-] for 2 sec. once or twice to cancel the tone squelch or pocket beep. (p. 11)
- ② Select the desired channel with the [▲]/[▼] switches.
 - When receiving a signal, "BUSY" appears and audio is emitted from the speaker.
 - Further adjustment of [VOL] may be necessary at this point.
 - Push [-] to toggle the monitor function ON and OFF. (p. 6)
- ③ Push [LOW] to select the output power if necessary.
 - "LOW" appears when low power is selected.
 - Choose low power to conserve battery power, choose high power for longer distance communications.
- ④ Push and hold [PTT] to transmit, then speak into the microphone.
 - Transmit indicator lights.
- ⑤ Release [PTT] to receive.

IMPORTANT: To maximize the readability of your transmitted signal, pause a few sec. after pushing [PTT], hold the microphone 10 to 15 cm from your mouth and speak at a normal voice level.

NOTE: The transceiver has a power save function to conserve battery power. The power save function activates automatically when no signal is received for 5 sec.

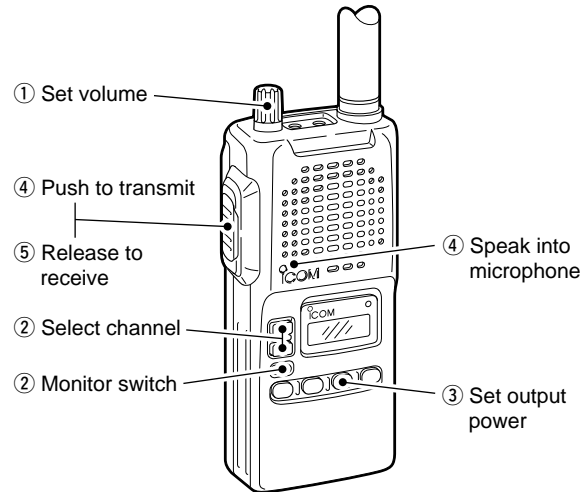

3 BASIC OPERATION

■ Display backlighting

The transceiver has display backlighting with a 5 or 10 sec. timer for nighttime operation. The display backlighting can be turned ON continuously or turned OFF, if desired.

- ➔ Push any switch except [PTT] to turn the backlighting ON.
 - When the 5 or 10 sec. timer is set, the backlighting will automatically turn OFF when switches have not been operated for 5 or 10 sec., respectively.

◇ Setting the backlighting timer

USING SET MODE

- ① Push [LOW] for 2 sec. to enter set mode.
- ② Push [LOW] several times until "LI" appears.
- ③ Push [▲] or [▼] to select the backlighting timer.
- ④ Push [LOW] for 2 sec. to exit set mode.

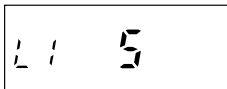

5 sec. timer



Continuously ON

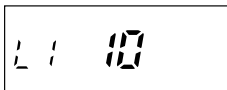

10 sec. timer

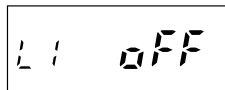

Continuously OFF

■ Lock function

The lock function prevents accidental channel changes and accidental function access. [PTT] and the backlight function can be used while the lock function is in use.

- ➔ Push [DUP] for 2 sec. to toggle the lock function ON and OFF.

"LO" appears when the lock function is in use.

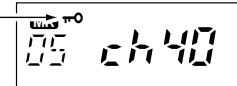

■ Monitor function

This function is used to listen to weak signals or to open the tone squelch manually.

- ➔ Push [-] to toggle the monitor function ON or OFF.



"MR" appears when the monitor function is in use.

■ Repeater operation

A repeater amplifies received signals and retransmits them on a different channel, allowing you to communicate over greater distances with improved reliability. When using a repeater, the transmit channel is shifted from the receive channel by 30 channels.

- ① Select the receive channel from 1 to 8 (repeater output channel).
- ② Push [DUP] to set duplex.
 - “DUP” appears.
 - The duplex setting affects the selected channel only and is automatically programmed into the selected channel.
- ③ Push and hold [PTT] to transmit.
 - The displayed channel automatically changes to the transmit channel (repeater input channel).
 - If “T SQL” appears on the display, push [-] for 2 sec. twice to cancel the tone squelch function.
- ④ Release [PTT] to receive.
- ⑤ To cancel the duplex setting, push [DUP] on the desired channel.

◇ Setting CTCSS tones for repeater and tone squelch operation

USING SET MODE

Repeaters may require CTCSS (subaudible) tones to be accessed. CTCSS tones are superimposed over your normal signal and must be set in advance.

This setting is commonly used for the tone squelch operation.

- ① Select the desired memory channel to be programmed.
- ② Push [LOW] for 2 sec. to enter set mode.
- ③ Push [LOW] several times until “Ct” appears.
- ④ Push [▲] or [▼] to select the CTCSS tone frequency.
- ⑤ Push [LOW] for 2 sec. to exit set mode.

67.0	79.7	97.4	118.8	146.2	167.9	186.2	206.5	241.8
69.3	82.5	100.0	123.0	151.4	171.3	189.9	210.7	250.3
71.0	85.4	103.5	127.3	156.7	173.8	192.8	218.1	254.1
71.9	88.5	107.2	131.8	159.8	177.3	196.6	225.7	
74.4	91.5	110.9	136.5	162.2	179.9	199.5	229.1	
77.0	94.8	114.8	141.3	165.5	183.5	203.5	233.6	

(Unit: Hz)

■ Scan types

The transceiver has 3 scan types with tag functions and 4 resume conditions providing scanning versatility.

Tag channels are independently set for open, group and priority scans. Initially, all channels may be set as tag channels for all scans.

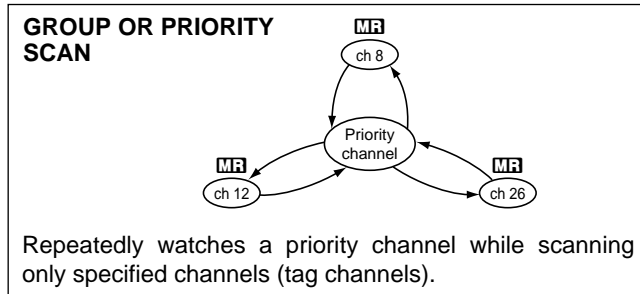
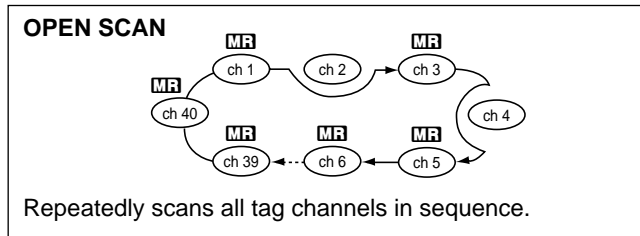

■ Open scan

Open scan searches for transmitted signals automatically and makes it easier to locate new stations for contact or listening purposes.

During open scan, transmission is not possible except on a busy channel.

- ① Push [O/G] to select open scan.
 - "OS" appears when the open scan is selected.
- ② Push [SCN] to start open scan.
 - Cancelling tag channels speeds up the scan interval. (p. 9)

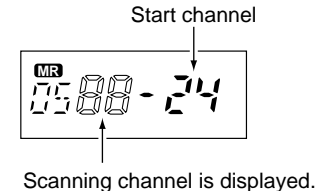

- ③ When receiving a signal, scan pauses and resumes according to the selected scan resume condition. (p. 10)
- ④ Push [SCN] to stop the scan.

■ Group and priority scans

Group and priority scans repeatedly watch a priority channel while scanning only specified channels. This is useful when waiting for calls on the priority channel or several specified channels.

Group and priority scans behave differently when transmitting. During group scan, transmission is possible on a busy channel only. During priority scan, transmission is possible on a priority channel (or start channel) only.

① Push [O/G] to select open scan.

- "GS" or "PS" appears when the group or priority scan is selected, respectively.

② Select the priority channel if desired.

- Push [▲] or [▼] key to select a channel.
- Push [O/G] for 2 sec. to set the channel to the priority channel.

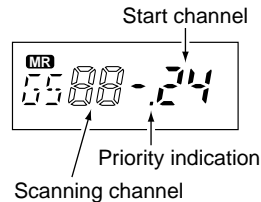

③ Push [SCN] to start group or priority scan.

- Cancelling tag channels speeds up the scan interval.

④ When receiving a signal, scan pauses and resumes according to the selected scan resume condition. (p. 10)

⑤ Push [SCN] to stop the scan.

■ Setting scan tag

Scan tag must be set before starting scan. Tag channels are independently set for open, group and priority scan.

- ① Select the desired channel.
- ② Push [O/G] to select the desired scan type.
- ③ Push [SCN] for 2 sec. to set the channel as a tag channel.
 - "MR" appears for tag channels.
- ④ Repeat step ③ to cancel the tag channel setting.

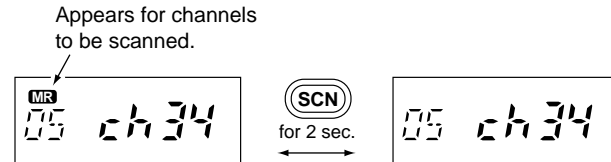

For open scan, cancel the tag channel setting to skip undesired channels such as usually busy channels. This speeds up the scan interval. All memory channels may be set as tag channels by default.

For group scan, set only often-used channels as tag channels. All memory channels may be set as tag channels by default.

4 SCAN OPERATION

■ Scan resume condition

USING SET MODE

The scan resume condition can be selected as a pause or timer scan.

- ① Push [LOW] for 2 sec. to enter set mode.
- ② Push [LOW] several times until "SC" appears.
- ③ Push [▲] or [▼] to select the scan resume timer.
 - "t-05" : Scan pauses 5 sec. while receiving a signal.
 - "t-10" : Scan pauses 10 sec. while receiving a signal.
 - "t-15" : Scan pauses 15 sec. while receiving a signal.
 - "P-05" : Scan pauses until the signal disappears and then resumes 5 sec. thereafter.
- ④ Push [LOW] for 2 sec. to exit set mode.

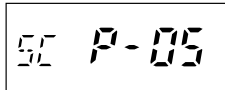

Pauses until the signal disappears.

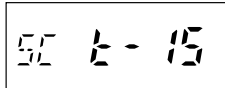

15 sec. timer for resume condition.

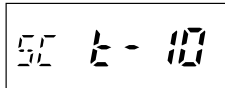

10 sec. timer for resume condition.

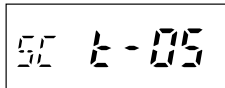

5 sec. timer for resume condition.

■ Tone squelch operation

The tone squelch opens only when receiving a signal containing a matching CTCSS (subaudible) tone. You can silently wait for calls from group members using the same tone.

- ① Set the desired channel.
- ② Set the desired CTCSS tone in set mode.
 - See p. 7 for tone frequencies and programming information.
- ③ Push [-] for 2 sec. several times until "TSQL" appears.
- ④ When the received signal includes a matching tone, squelch opens and the signal can be heard.
 - When the received signal's tone does not match, tone squelch does not open, however, the S-indicator shows signal strength.
 - To open the squelch manually, push [-].
- ⑤ Operate the transceiver in the normal way.
- ⑥ To cancel the tone squelch, push [-] for 2 sec. twice.

NOTE: The transceiver has 51 tone frequencies and consequently their spacing is narrow compared with units having 38 tones. Therefore, some tone frequencies may receive interference from adjacent tone frequencies.

Tone frequencies and tone squelch ON/OFF settings are automatically stored in memory channels for easy recall.

■ Pocket beep operation

This function uses CTCSS (subaudible) tones for calling and can be used as a "common pager" to inform you that someone has called while you were away from the transceiver.

◇ Waiting for a call from a specific station

- ① Set the operating channel.
- ② Set the desired CTCSS tone in set mode.
 - See p. 7 for tone frequencies and programming information.
- ③ Push [-] for 2 sec. several times until "TSQL" appears in the function display.
- ④ When a signal with the correct tone is received, the transceiver emits beep tones and flashes "TSQL".
- ⑤ Push [PTT] to answer or push [-] to stop the beeps and flashing.
 - Tone squelch is automatically selected.

◇ Calling a waiting station using pocket beep

A subaudible tone matched with the station's tone frequency is necessary. Use the tone squelch at left or a CTCSS (subaudible) tone encoder (p. 7).

■ Charging precautions

NEVER attempt to charge dry cell batteries. This will cause internal liquid leakage and damage the battery case and transceiver.

NEVER connect two or more chargers at the same time.

Charging may not occur under temperatures of 10°C (50°F) or over temperatures of 40°C (104°F).

When using BC-119: If the charge indicator flashes orange, vehicle battery voltage is low and charging is not possible. Check the vehicle battery voltage in this case. If the charge indicator flashes red, there may be a problem with the battery pack (or charger). Re-insert the battery pack or contact your dealer.

■ Battery pack charging

The BP-195 or BP-196 BATTERY PACK includes rechargeable Ni-Cd batteries and can be charged approx. 300 times. Charge the battery pack before first operating the transceiver or when the battery pack becomes exhausted.

If you want to be able to charge the battery pack more than 300 times, the following points should be observed:

1. Avoid overcharging. The charging period should be less than 48 hours.
2. Use the battery until it becomes almost completely exhausted under normal conditions. We recommend battery charging just after transmitting becomes impossible.

◇ Rapid charging with the BC-119

The optional BC-119 provides rapid charging of battery packs.

One AD-81 and an AC adapter (may be supplied with the BC-119 depending on version) are additionally required.

- **Charging periods:** 1.5 hours (w/BP-195)
2 hours (w/BP-196)

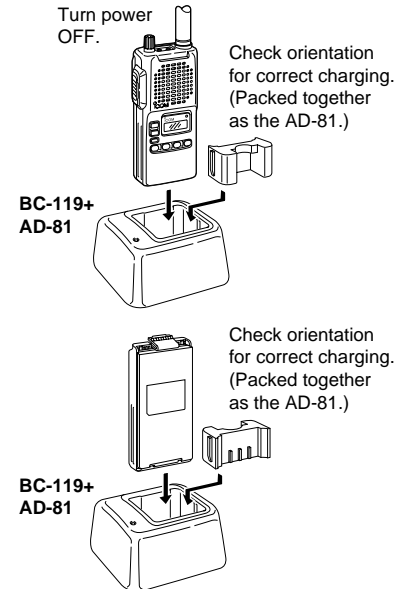

◆ Multiple charging with the BC-121

The optional BC-121 allows up to 6 battery packs to be charged simultaneously.

Six AD-81's and an AC adapter (may be supplied with the BC-121 depending on version) are additionally required.

- **Charging periods:** 1.5 hours (w/BP-195)
2 hours (w/BP-196)

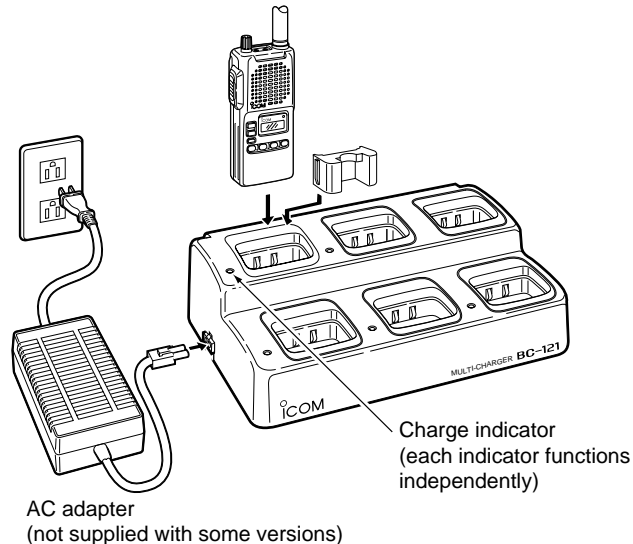

◆ Regular charging

- ① Attach the battery pack to the transceiver.
- ② Be sure to turn the transceiver power OFF.
- ③ Connect the AC adapter (BC-110V) or optional cable (CP-12L or OPC-254L) as shown below.

- **Charging periods:** 10 hours (w/BP-195)
15 hours (w/BP-196)

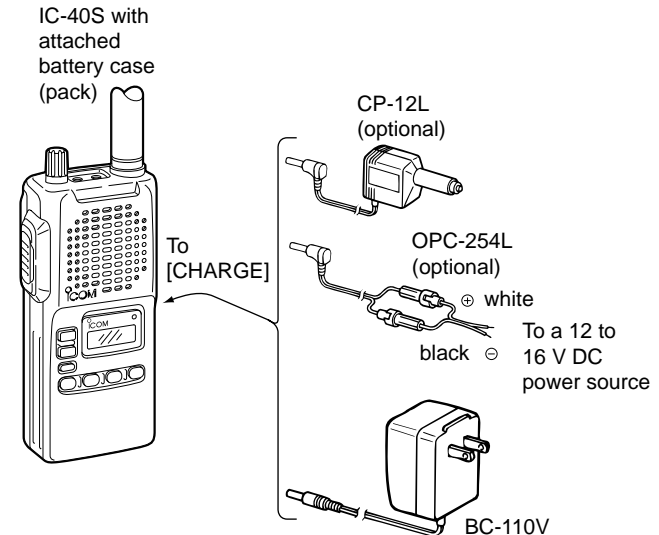

6 BATTERY PACKS

■ About the battery pack

◇ Operating period

Depending on the attached battery pack, the operating period of the transceiver varies. Refer to the last page for battery pack specifications.

◇ Battery pack life

If your battery pack seems to have no capacity even after being fully charged, completely discharge it by leaving the power ON overnight. Then, fully charge the battery pack again.

If the battery pack still does not retain a charge (or very little), a new battery pack must be purchased.

■ Installing batteries in the battery case

When using a battery case, install 8 AA (R6) size Ni-Cd or alkaline batteries as illustrated below.

- ① Remove the battery case from the transceiver.

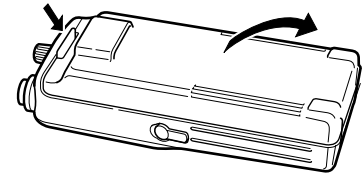

- ② Install 8 × AA (R6) size Ni-Cd or alkaline batteries.
 - Be sure to observe the correct polarity.

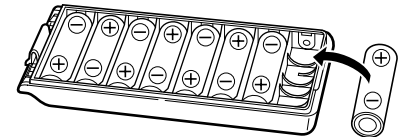

- **NEVER** connect DC power to the transceiver when installing dry cell or alkaline batteries. Such a connection will damage the transceiver.
- Be careful of battery overcharging. When operating via external DC power, installed batteries are simultaneously charged.
- Keep battery contacts clean. It's a good idea to clean battery terminals once a week.

■ Time-out timer

USING SET MODE

To prevent continuous, extend transmissions, the transceiver has a time-out timer. This timer turns a transmission OFF 1, 2, 3 or 4 min. after it starts. This timer can be cancelled.

Approx. 5 sec. before the time-out time elapses, the transceiver emits a beep tone.

- ① Push [LOW] for 2 sec. to enter set mode.
- ② Push [LOW] several times until "tt" appears.
- ③ Push [▲] or [▼] to select the time-out time or to turn the function OFF.
- 1, 2, 3 and 4 minutes and OFF are available.
- ④ Push [LOW] for 2 sec. to exit set mode.

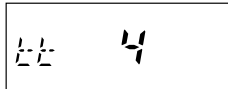

4 min. time-out timer is selected.

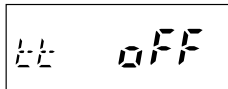

Time-out timer is cancelled.

■ Power saver

USING SET MODE

The power saver function reduces the current drain to conserve battery power.

- ① Push [LOW] for 2 sec. to enter set mode.
- ② Push [LOW] several times until "PS" appears.
- ③ Push [▲] or [▼] to turn the power saver ON or OFF, respectively.
- ④ Push [LOW] for 2 sec. to exit set mode.

■ Confirmation beeps

USING SET MODE

You can select silent operation by turning beep tones OFF or you can have confirmation beeps sound at the push of a switch by turning beep tones ON. The beep tone volume is linked with [VOL].

- ① Push [LOW] for 2 sec. to enter set mode.
- ② Push [LOW] several times until "bE" appears.
- ③ Push [▲] or [▼] to turn the confirmation beep ON or OFF, respectively.
- ④ Push [LOW] for 2 sec. to exit set mode.

7 OTHER FUNCTIONS

■ Transmit lockout

The transmit lockout function inhibits transmission while receiving a signal or when receiving a signal with an unmatched CTCSS tone.

- ① Push [LOW] for 2 sec. to enter set mode.
- ② Push [LOW] several times until "Lo" appears.
- ③ Push [▲] or [▼] to select the transmit lockout function or to turn the function OFF.

- "RPt" :

Transmission is impossible when receiving a signal with an unmatched CTCSS tone.

- "bUSy" :

Transmission is impossible when receiving a signal.

- "oFF" :

Transmission is always possible.

- ④ Push [LOW] for 2 sec. to exit set mode.

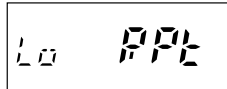

Transmission is impossible when receiving a signal with an unmatched CTCSS tone.

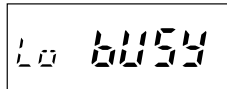

Transmission is impossible when receiving a signal.

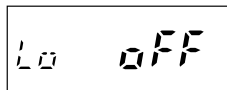

Lockout function is cancelled.

■ Optional HM-75A functions

CAUTION: When connecting the HM-75A to the transceiver, make sure that power to the transceiver is turned OFF, otherwise the CPU may malfunction.

◇ Turning the microphone remote control function ON/OFF

- ① Push [LOW] for 2 sec. to enter set mode.
- ② Push [LOW] several times until "mC" appears.
- ③ Push [▲] or [▼] to turn the microphone remote control function ON or OFF, respectively.
- ④ Push [LOW] for 2 sec. to exit set mode.

◇ HM-75A functions

The optional HM-75A allows you to remotely select operating channels, output power, etc.

A SWITCH

Toggles monitor function ON and OFF.

B SWITCH

Selects the output power.

▲/▼ SWITCHES

Selects the operating channels.

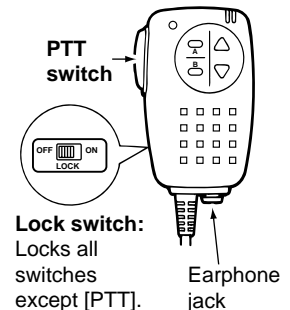

If your transceiver seems to be malfunctioning, please check the following points before sending it to a service center.

PROBLEM	POSSIBLE CAUSE	SOLUTION	REF.
No power comes ON.	<ul style="list-style-type: none"> •The battery is exhausted. •Bad connection to the battery pack. 	<ul style="list-style-type: none"> •Recharge the battery pack. •Check the connection to the transceiver. 	p. 12 —
No sound comes from the speaker.	<ul style="list-style-type: none"> •Volume level is too low. •Tone squelch is activated. 	<ul style="list-style-type: none"> •Set [VOL] to a suitable level. •Turn the tone squelch OFF. 	p. 5 p. 11
Transmitting is impossible.	<ul style="list-style-type: none"> •The battery is exhausted. 	<ul style="list-style-type: none"> •Recharge the battery pack. 	p. 12
No contact possible with another station.	<ul style="list-style-type: none"> •The transceiver is set to semi-duplex. •The other station is using tone squelch. 	<ul style="list-style-type: none"> •Push [DUP] to set to simplex. •Turn ON the tone squelch function. 	p. 7 p. 11
The displayed channel cannot be changed.	<ul style="list-style-type: none"> •Lock function is activated. 	<ul style="list-style-type: none"> •Push [DUP] for 1 sec. to cancel the function. 	p. 7
Scan does not start.	<ul style="list-style-type: none"> •The monitor function is activated. •Scan tag is not programmed. 	<ul style="list-style-type: none"> •Push [-] to cancel the function. •Set scan tag to desired channels. 	p. 6 p. 9
No beep sounds.	<ul style="list-style-type: none"> •Beep tones are turned OFF. 	<ul style="list-style-type: none"> •Turn beep tones ON in SET mode. 	p. 15

◇ General

- Frequency coverage : 450.000–480.000 MHz
(Incl. all 40 UHF C.R.S. ch.)
- Mode : FM (16K0F3E)
- Tuning step increment : 25 kHz
- Acceptable power supply (negative ground) : 9.6 V DC nominal
(authorized battery packs)
- Usable temp. range : -10°C to $+60^{\circ}\text{C}$
- Frequency stability : ± 5 ppm
- Current drain (approx.) :

Tx	at 5 W	1.6 A
	at 1 W	0.7 A
Rx	standby	60 mA
	max. audio	250 mA
	power saved	13 mA
- Antenna impedance : 50 Ω (nominal)
- Dimensions : 57(W) X 140(H) X 37(D) mm
(projections not incl.)
- Weight (with BP-195) : 370 g

◇ Transmitter

- Output power : Max. 5 W (at 9.6 V DC)
- Modulation : Variable reactance frequency modulation
- Max. frequency deviation : ± 5 kHz
- Spurious emissions : 70 dB typical
- Adjacent channel power : 70 dB typical
- External mic. connector : 3-conductor 2.5 (d) mm/2 k Ω

◇ Receiver

- Receive system : Double conversion superheterodyne
- Intermediate frequencies : 1st 46.35 MHz
2nd 450 kHz
- Sensitivity : 0.25 μV at 12 dB SINAD
- Squelch sensitivity : 0.25 μV typical (at threshold)
- Adjacent ch. selectivity : 70 dB typical
- Spurious response : 70 dB typical
- Intermodulation rejection : 65 dB typical
- Audio output power : 500 mW typical at 10%
(at 9.6 V DC) distortion with an 8 Ω load
- External SP connector : 2-conductor 3.5 (d) mm/8 Ω

All stated specifications are subject to change without notice or obligation.

◇ Battery packs

Battery pack	Voltage	Capacity	Charging period		Operating period*1
			Wall charger	BC-119 or BC-121 with AD-81	
BP-194	Battery case for AA (R6) × 8 alkaline or Ni-Cd cells		10 hrs*2	N/A	6 hrs*2
BP-195	9.6 V	700 mAh	10 hrs	1.5 hrs	6 hrs
BP-196	9.6 V	1050 mAh	15 hrs	2.0 hrs	9.5 hrs

*1 Operating periods are calibrated for the following conditions:
at 25°C (77°F), Tx (high power) : Rx : standby = 5 : 5 : 90

*2 When Ni-Cd batteries are installed.

◇ Other options

BC-110V WALL CHARGER

Used for regular charging of the connected battery pack.

BC-119 DESKTOP CHARGER + **AD-81** CHARGER ADAPTOR

For rapid charging of battery packs. An AC adapter is supplied with the charger. Some BC-119 versions require the AD-75 additionally. Charging time: 1.5 to 2 hrs.

BC-121 MULTI-CHARGER + **AD-81** CHARGER ADAPTOR

For rapid charging up to 6 battery packs simultaneously. An AC adapter may be supplied depending on version. Six AD-81's are necessary. Charging time: 1.5 to 2 hrs.

HM-46 SPEAKER-MICROPHONE

Slim dimensions. Equipped with an earphone jack and a transmit indicator.

HM-54 SPEAKER-MICROPHONE

For operation while conveniently hanging the transceiver from your belt, etc.

HM-75A SPEAKER-MICROPHONE

Allows you to remotely select operating channels, etc.

HS-51 HEADSET

For hands-free operation. Includes VOX, PTT and "one-touch" PTT with a time-out timer.

MB-68 BELT CLIP

Allows you to attach the transceiver to your belt. Same as supplied.

LC-145 CARRYING CASE / **LC-40S** LEATHER CASE

Helps protect the transceiver from scratches, etc. Usable with any battery pack. The LC-40S includes a belt clip for attaching the transceiver to your belt.

OPC-254L DC POWER CABLE

CP-12L CIGARETTE LIGHTER CABLE WITH NOISE FILTER

Allows you to charge a battery pack connected to the transceiver via a DC power source (12–16 V DC) For charging ONLY—the transceiver cannot be simultaneously operated.

SP-13 EARPHONE

Provides clear audio in noisy environments.

EX-2118 FIELD PROGRAMMING SOFTWARE + **OPC-478** CLONING CABLE

Provides quick and easy programming of items, including private channels, scan settings, etc., via an IBM® compatible PC.

IBM® is a registered trademark of International Business Machines.

Count on us!

A-5462H-1AU-①
Printed in Japan
Copyright 1997 Icom Inc.

Icom Inc.
6-9-16 Kamihigashi, Hirano-ku, Osaka 547 Japan

Free Manuals Download Website

<http://myh66.com>

<http://usermanuals.us>

<http://www.somanuals.com>

<http://www.4manuals.cc>

<http://www.manual-lib.com>

<http://www.404manual.com>

<http://www.luxmanual.com>

<http://aubethermostatmanual.com>

Golf course search by state

<http://golfingnear.com>

Email search by domain

<http://emailbydomain.com>

Auto manuals search

<http://auto.somanuals.com>

TV manuals search

<http://tv.somanuals.com>