



## INSTRUCTION MANUAL

VHF AIR BAND TRANSCEIVER

# IC-A24 IC-A6

This device complies with Part 15 of the FCC Rules. Operation is subject to the condition that this device does not cause harmful interference.

**Icom Inc.**

Download from [www.Somanuals.com](http://www.Somanuals.com). All Manuals Search And Download.



IC-A24

IC-A6

---

# SAFETY TRAINING INFORMATION

---



Your Icom radio generates RF electromagnetic energy during transmit mode. This radio is designed for and classified as “Occupational Use Only”, meaning it must be used only during the course of employment by individuals aware of the hazards, and the ways to minimize such hazards. This radio is NOT intended for use by the “General Population” in an uncontrolled environment.

This radio has been evaluated for compliance at the distance of 2.5 cm with the FCC RF exposure limits for “Occupational Use Only”. In addition, your Icom radio complies with the following Standards and Guidelines with regard to RF energy and electromagnetic energy levels and evaluation of such levels for exposure to humans:

- FCC OET Bulletin 65 Edition 97-01 Supplement C, Evaluating Compliance with FCC Guidelines for Human Exposure to Radio Frequency Electromagnetic Fields.
- American National Standards Institute (C95.1-1992), IEEE Standard for Safety Levels with Respect to Human Exposure to Radio Frequency Electromagnetic Fields, 3 kHz to 300 GHz.
- American National Standards Institute (C95.3-1992), IEEE Recommended Practice for the Measurement of Potentially Hazardous Electromagnetic Fields— RF and Microwave.
- The following accessories are authorized for use with this product. Use of accessories other than those specified may result in RF exposure levels exceeding the FCC requirements for wireless RF exposure.: Belt Clip (MB-86/103), Rechargeable Ni-MH Battery Pack (BP-210N) and Alkaline Battery Case (BP-208N).



**To ensure that your exposure to RF electromagnetic energy is within the FCC allowable limits for occupational use, always adhere to the following guidelines:**

- **DO NOT** operate the radio without a proper antenna attached, as this may damage the radio and may also cause you to exceed FCC RF exposure limits. A proper antenna is the antenna supplied with this radio by the manufacturer or antenna specifically authorized by the manufacturer for use with this radio.
- **DO NOT** transmit for more than 50% of total radio use time (“50% duty cycle”). Transmitting more than 50% of the time can cause FCC RF exposure compliance requirements to be exceeded. The radio is transmitting when “**(TX)**” appears on the function display. You can cause the radio to transmit by pressing the “PTT” switch.
- **ALWAYS keep** the antenna at least 2.5 cm (1 inch) away from the body when transmitting and only use the Icom belt-clips which are listed on page 31 when attaching the radio to your belt, etc., to ensure FCC RF exposure compliance requirements are not exceeded. To provide the recipients of your transmission the best sound quality, hold the antenna at least 5 cm (2 inches) from your mouth, and slightly off to one side.

The information listed above provides the user with the information needed to make him or her aware of RF exposure, and what to do to assure that this radio operates with the FCC RF exposure limits of this radio.

## Electromagnetic Interference/Compatibility

During transmissions, your Icom radio generates RF energy that can possibly cause interference with other devices or systems. To avoid such interference, turn off the radio in areas where signs are posted to do so. **DO NOT** operate the transmitter in areas that are sensitive to electromagnetic radiation such as hospitals and blasting sites.

## Occupational/Controlled Use

The radio transmitter is used in situations in which persons are exposed as consequence of their employment provided those persons are fully aware of the potential for exposure and can exercise control over their exposure.

## FOREWORD

Thank you for purchasing this Icom product. The IC-A24/A6 VHF AIR BAND TRANSCEIVER is designed and built with Icom's state of the art technology and craftsmanship. With proper care this product should provide you with years of trouble-free operation.

## IMPORTANT

**READ ALL INSTRUCTIONS** carefully and completely before using the transceiver.

**SAVE THIS INSTRUCTION MANUAL**— This instruction manual contains important operating instructions for the IC-A24/A6.

## EXPLICIT DEFINITIONS

WORD	DEFINITION
<b>⚠ WARNING</b>	Personal injury, fire hazard or electric shock may occur.
<b>CAUTION</b>	Equipment damage may occur.
<b>NOTE</b>	If disregarded, inconvenience only. No risk of personal injury, fire or electric shock.

## SUPPLIED ACCESSORIES

Accessories included with the transceiver:	Qty.
① Antenna .....	1
② Belt clip .....	1
③ Handstrap .....	1
④ Battery pack* or battery case .....	1
⑤ Wall charger* .....	1
⑥ Carrying case* .....	1
⑦ Headset adapter* .....	1

\*The battery pack, wall charger, headset adapter or carrying case may differ depending on version. Some versions do not include a battery pack, wall charger, headset adapter or carrying case.

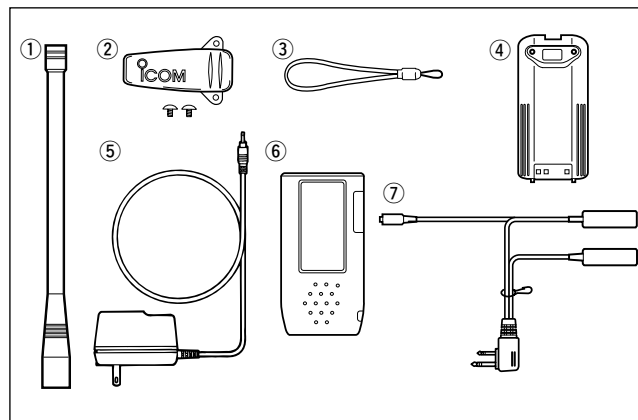

---

## PRECAUTION

---

**⚠ WARNING! NEVER** hold the transceiver so that the antenna is very close to, or touching exposed parts of the body, especially the face or eyes, while transmitting. The transceiver will perform best if the microphone is 5 to 10 cm away from the lips and the transceiver is vertical.

**⚠ WARNING! NEVER** operate the transceiver with a headset or other audio accessories at high volume levels. Hearing experts advise against continuous high volume operation. If you experience a ringing in your ears, reduce the volume level or discontinue use.

**NEVER** connect the transceiver to an AC outlet or to a power source of more than 11.5 V DC. Such a connection will damage the transceiver.

**NEVER** connect the transceiver to a power source that is DC fused at more than 5 A. Accidental reverse connection will be protected by this fuse, higher fuse values will not give any protection against such accidents and the transceiver will be ruined.

**NEVER** short the terminals of the battery pack. Also, current may flow into nearby metal objects, such as a necklace, etc. Therefore, be careful when carrying with, or placing near metal objects, carrying in handbags, etc.

**DO NOT** allow children to play with any radio equipment containing a transmitter.

**DO NOT** operate the transceiver near unshielded electrical blasting caps or in an explosive atmosphere.

**AVOID** using or placing the transceiver in direct sunlight or in areas with temperatures below  $-10^{\circ}\text{C}$  ( $+14^{\circ}\text{F}$ ) or above  $+60^{\circ}\text{C}$  ( $+140^{\circ}\text{F}$ ).

The use of non-Icom battery packs/chargers may impair transceiver performance and invalidate the warranty.

Even when the transceiver power is OFF, a slight current still flows in the circuits. Remove the battery pack or case from the transceiver when not using it for a long time. Otherwise, the battery pack or installed dry cell batteries will become exhausted.

**FCC caution:** *Changes or modifications to this transceiver, not expressly approved by Icom Inc., could void your authority to operate this transceiver under FCC regulations. (U.S.A. only)*

Icom, Icom Inc. and the ICOM logo are registered trademarks of Icom Incorporated (Japan) in the United States, the United Kingdom, Germany, France, Spain, Russia and/or other countries.

---

# TABLE OF CONTENTS

---

SAFETY TRAINING INFORMATION .....	i		
FOREWORD .....	ii		
IMPORTANT .....	ii		
EXPLICIT DEFINITIONS .....	ii		
SUPPLIED ACCESSORIES .....	ii		
PRECAUTIONS.....	iii		
TABLE OF CONTENTS .....	iv		
<b>1 PANEL DESCRIPTION .....</b>	<b>1–6</b>		
■ Panel description .....	1		
■ Function display .....	5		
<b>2 ACCESSORY ATTACHMENT .....</b>	<b>7</b>		
<b>3 BASIC OPERATION .....</b>	<b>8–11</b>		
■ Setting a frequency .....	8		
■ Setting a squelch level .....	8		
■ Selecting a weather channel.....	8		
■ Receiving .....	9		
■ Transmitting .....	9		
■ ANL function .....	9		
■ Low battery indicator .....	10		
■ Recall function .....	10		
■ Setting weather alert function.....	11		
■ Accessing 121.5 MHz emergency frequency .....	11		
■ Lock function .....	11		
■ Side tone function .....	11		
■ Setting beep tone .....	11		
■ Backlighting .....	11		
<b>4 MEMORY OPERATION .....</b>	<b>12–15</b>		
■ Memory channel selection .....	12		
■ Transferring memory contents .....	12		
■ Programming a memory channel .....	13		
■ Memory names .....	14		
■ Clearing the memory contents .....	14		
<b>5 SCAN OPERATION .....</b>	<b>16–17</b>		
■ Scan types .....	16		
■ COM band scan .....	16		
■ Memory scan .....	16		
■ Weather channel scan (U.S.A. version only) .....	17		
■ “TAG” channels .....	17		
<b>6 VOR NAVIGATION (IC-A24 only) .....</b>	<b>18–24</b>		
■ VOR indications .....	18		
■ VOR functions .....	19		
■ Flying to a VOR station .....	20		
■ Entering a desired course .....	22		
■ Crosschecking position .....	22		
■ Duplex operation (U.S.A. version only) .....	24		
<b>7 BATTERY PACKS .....</b>	<b>25–27</b>		
■ Battery charging .....	25		
■ Battery cautions .....	25		
■ Optional battery case .....	26		
■ Optional battery chargers .....	27		
<b>8 CLONING .....</b>	<b>28</b>		
<b>9 TROUBLESHOOTING .....</b>	<b>29</b>		
<b>10 SPECIFICATIONS .....</b>	<b>30</b>		
<b>11 OPTIONS .....</b>	<b>31</b>		
<b>12 QUICK REFERENCE .....</b>	<b>32–33</b>		
<b>13 OPTIONAL HEADSET CONNECTION .....</b>	<b>34</b>		

# 1

## PANEL DESCRIPTION

### ■ Panel description

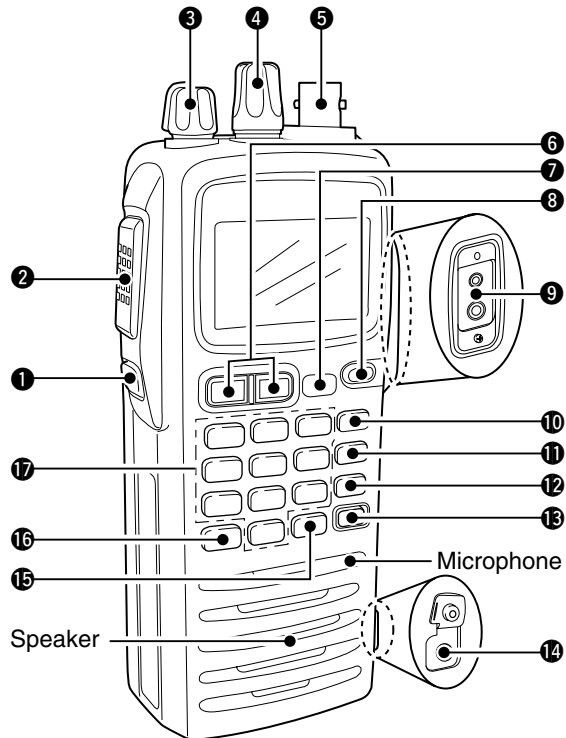

IC-A24

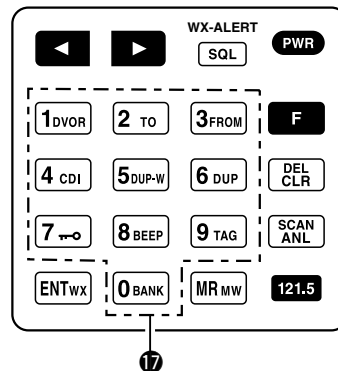

IC-A6

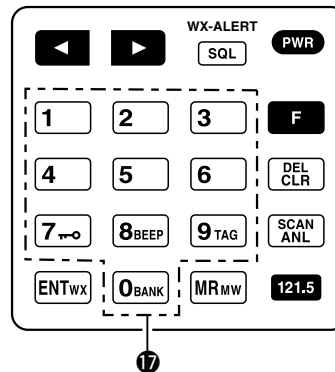



**1 BACKLIGHT SWITCH [LIGHT]** (p. 11)  
Turns the backlight for display and keypad ON or OFF.

**2 PTT SWITCH [PTT]** (p. 9)  
Push and hold to transmit; release to receive.  
•“TX” appears on the function display while transmitting.

**3 VOLUME [VOL]** (p. 9)  
Adjusts the audio level.

**4 TUNING DIAL [DIAL]** (pgs. 8–12)  
➔ Rotate [DIAL] to select the desired frequency, WX channel number, BANK number and memory channel.  
➔ Rotate [DIAL] to set the squelch level and beep tone level.



**5 ANTENNA CONNECTOR [ANT]** (p. 7)  
Connects the supplied antenna.

**6 RECALL CHANNEL UP/DOWN KEYS [◀]/[▶]** (p. 10)  
 ➔ Push to enter the recall function mode.  
➔ Push to call the stored frequency in the recall mode.  
 ➔ Push **F**, then push [◀]/[▶] to replace stored recall frequencies to back or front.

**7 SQUELCH KEY [SQL•WX-ALERT]** (p. 8)  
 ➔ Push [SQL•WX-ALERT], then rotate [DIAL] to select the squelch level.  
• 24 squelch levels and squelch open (0) are available.  
➔ Push **F**, then push [SQL•WX-ALERT] to turn the WX-alert function ON or OFF.

**8 POWER SWITCH [PWR]** (pgs. 9, 28)  
 ➔ Push and hold for 2 sec. to turn the power ON or OFF.  
➔ While pushing and holding [MR•MW], push [PWR] to enter the cloning function mode.

**9 EXTERNAL SPEAKER AND MICROPHONE JACKS [MIC/SP]** (p. 34)  
Connects an OPC-499 HEADSET ADAPTER and headset, if desired.

**10 FUNCTION KEY **  
 Push to call up the function indicator, “**F**”, then push another key to access its secondary function.  
• “**F**” appears for 3 sec. after **F** is pushed; at this time pushing **F** again cancels the indication.  
 **NOTE:** In general, “**F**” disappears when another key is pushed to activate a secondary function. However, some keys which have more than one secondary function, (such as [DUP]), do not cancel “**F**”. In this case, “**F**” disappears automatically after 3 sec.

# 1 PANEL DESCRIPTION

## 11 CLEAR KEY [CLR•DEL] (pgs. 8–17)

DEL  
CLR

- ➔ Push to turn to the frequency mode, when memory channel, WX channel, 121.5 MHz, squelch level setting or beep tone setting is selected.
- ➔ Push **F**, then push and hold [CLR•DEL] to delete a recall frequency data.
- ➔ Push to clear the entered comment of memory name while programming.
- ➔ Push to stop the scan function to turn to the frequency mode while the scan function is operating.

## 12 ANL KEY [ANL•SCAN] (pgs. 9, 16, 17)

SCAN  
ANL

- ➔ Push to turn the ANL function ON or OFF.
- ➔ Push **F**, then push [ANL•SCAN] to start the scan function.

## 13 EMERGENCY KEY [121.5 MHz] (p. 11)

121.5

- ➔ Push for 2 sec. to select the 121.5 MHz emergency frequency.

## 14 DC POWER JACK

Connect the AC adapter or optional cable to charge the battery pack or to operate by external power supply. (see right illustration)

## 15 MEMORY MODE KEY [MR•MW] (pgs. 12–15)

MR  
MW

- ➔ Push to call the memory channel mode.
- ➔ Push **F**, then push [MR•MW] to program the contents into the memory channels.

## 16 ENTER KEY [ENT•WX] (pgs. 8, 14)

ENT  
WX

- ➔ Push to enter the numeral input. Enters consecutive zero digits. (p. 8)
- ➔ Push **F**, then push [ENT•WX] to enter the weather channel selection mode (U.S.A. version only). (p. 8)
- ➔ Push to program the memory name. (p. 14)

**NOTE:** Some functions may not be available depending on versions. Ask your authorized dealer for details.

## • DC POWER CONNECTION

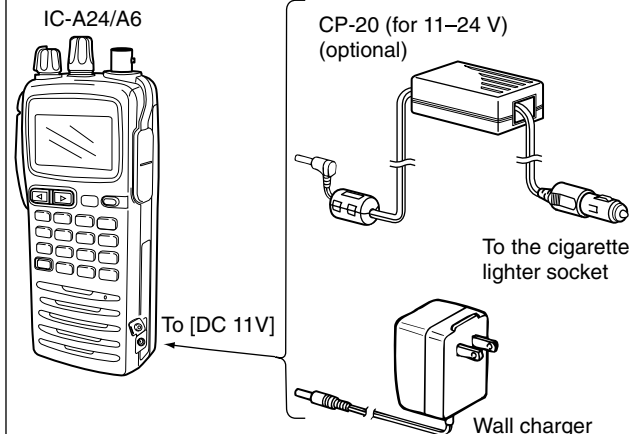



**17 DIGIT KEYS**

- Input the specified digit during frequency input, memory channel selection, etc.
- In addition, each key has one or more secondary function after pushing **F** as follows:

**0 BANK** Push **F**, then push [0•BANK] to select the memory BANK number to rotate [DIAL] on the memory operation. (p. 12)

**1 DVOR** Push **F**, then push [1•DVOR] to select the DVOR display from the CDI display in NAV band. (p. 19)\*<sup>1</sup>

**2 TO** ➤ Push **F**, then push [2•TO] to change the course indicator characteristics to “TO” flag in the DVOR display in NAV band. (p. 19)\*<sup>1</sup>  
 ➤ Corrects the deviation while using “TO” flag. \*<sup>1</sup>

**3 FROM** ➤ Push **F**, then push [3•FROM] to change the course indicator characteristics to “FROM” flag in the DVOR display in NAV band. (p. 19)\*<sup>1</sup>  
 ➤ Corrects the deviation while using “FROM” flag. \*<sup>1</sup>

**4 CDI** Push **F**, then push [4•CDI] to select the CDI display from the CDI display in NAV band. (p. 19)\*<sup>1</sup>

**5 DUP-W** Push **F**, then push [5•DUP-W] to set the duplex frequency in NAV band for U.S.A. version only. (p. 24)\*<sup>1</sup>

**6 DUP** Push **F**, then push [6•DUP] to turn the duplex function ON and OFF in NAV band for U.S.A. version only. (p. 24)\*<sup>1</sup>

**7 TAG** Push **F**, then push [7•

**8 BEEP** Push **F**, then push [8•BEEP] to turn the beep tone setting mode ON (p. 11).  
 • Adjustable level; 0 to 9

**9 TAG** Push **F**, then push [9•TAG] to set the displayed memory or weather channel as a “TAG” channel. (p. 17)

\*<sup>1</sup> These functions available on the IC-A24 only.

# 1 PANEL DESCRIPTION

## ■ Function display

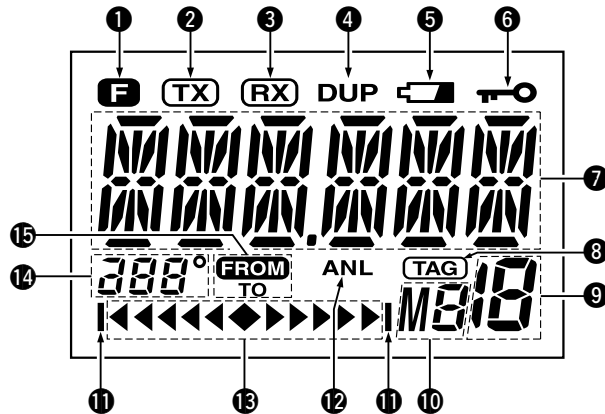

### 1 FUNCTION INDICATOR (p. 2)

Appears when **F** is pushed.

### 2 TX INDICATOR (p. 9)

Appears while transmitting.

### 3 RX INDICATOR (p. 9)

Appears when receiving a signal or when the squelch opens.

### 4 DUPLEX INDICATOR (IC-A24 only) (p. 24)

- “DUP” appears when the duplex function is activated in NAV mode.
- “DUP” blinks while setting the duplex frequency.

### 5 LOW BATTERY INDICATOR (p. 10)

- Appears when the battery is nearing exhaustion. The attached battery pack requires recharging.
- Appears and flashes when battery replacement is necessary.

### 6 LOCK INDICATOR (p. 11)

Appears while the lock function is in use.

### 7 FREQUENCY DISPLAY (pgs. 8, 14)

- Shows the operating frequency.
- Shows the channel name when the memory name function is selected.

**8 TAG CHANNEL INDICATOR** (p. 17)

“TAG” appears when the memory channel is set as a TAG channel.

**9 MEMORY CHANNEL INDICATOR** (pgs. 12–15)

Shows the memory channel number.

**10 MEMORY BANK NUMBER INDICATOR** (p. 12)

Shows the selected memory bank number.

**11 OVERFLOW INDICATOR** (IC-A24 only) (pgs. 18–22)

Appears when the deviation between the desired course and flying course is over 10 degrees.

**12 ANL INDICATOR** (p. 9)

Appears while the ANL (Automatic Noise Limiter) function is in use.

**13 COURSE DEVIATION NEEDLES** (IC-A24 only)  
(pgs. 18–22)

Indicates the deviation between the desired course and your actual flying course every 2 degrees.

**14 COURSE INDICATORS** (IC-A24 only) (p. 19)

- ➔ Indicates where your aircraft is located on a VOR radial in DVOR mode.
- ➔ Indicates where your desired course is located on a VOR radial in CDI mode.

**15 TO-FROM INDICATOR** (IC-A24 only) (p. 19)

Indicates whether the VOR navigation information is based on a course leading to the VOR station or leading away from the VOR station.

# 2

## ACCESSORY ATTACHMENT

### ◇ Antenna

**CAUTION: DO NOT** transmit without an antenna. Otherwise the transceiver may be damaged.

Insert the supplied antenna into the antenna connector and screw down the antenna as shown below.

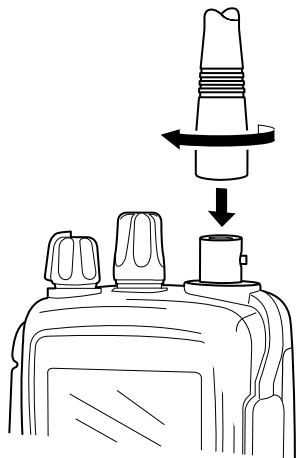

### ◇ Belt clip

Conveniently attaches to your belt.

Attach the belt clip with the supplied screws as below.

/// **NOTE:** Use the supplied screws only.

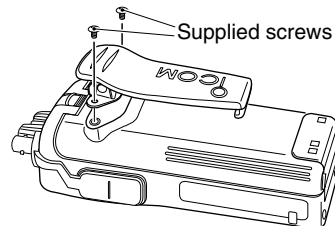

### ◇ Battery pack replacement

Before replacing the battery pack, push [PWR] for 2 sec. to turn the power OFF.

Slide the battery release button forward, then pull the battery pack upward with the transceiver facing away from you.

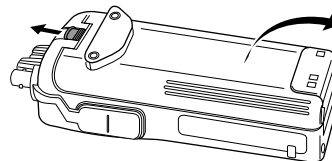

## ■ Setting a frequency

### ◇ Using keypad

- ① Push [PWR] for 2 sec. to turn power ON, then push [CLR•DEL] to select the frequency mode when memory CH number or WX CH number appears on the function display.
- ② Push 5 appropriate digit keys to input the frequency.
  - Push [1]\* as the 1st digit.
  - When a wrong digit is input, push [CLR•DEL] to clear, then repeat step ② again.
  - Push [ENT•WX] to enter consecutive zero digits.
  - Only [2]\*, [5]\*, [7•←○] and [0•BANK] can be entered as the 5th and final digit.

### [EXAMPLE]

- 111.225 MHz: Push
- 117.250 MHz: Push
- 120.000 MHz: Push
- 125.300 MHz: Push

### ◇ Using the tuning dial

- ① Push [PWR] for 2 sec. to turn power ON, then push [CLR•DEL] to select the frequency mode when memory CH number or WX CH number appears on the function display.
- ② Rotate [DIAL] to set the desired frequency.
  - To select the 1 MHz tuning step, push , then rotate [DIAL]. Push again to return the normal tuning.

## ■ Setting a squelch level

The transceiver has a noise squelch circuit to mute undesired noise while receiving no signal.

- ① Push [SQL•WX-ALERT], then rotate [DIAL] to select the squelch level.
  - 'SQL--0' is loose squelch and 'SQL--24' is tight squelch.
  - Appears "" while the squelch is open.
- ② Push [SQL•WX-ALERT] or [CLR•DEL] to exit the squelch set mode.

## ■ Selecting a weather channel (U.S.A. version only)

The U.S.A. version has VHF marine WX (weather) channel receiving capability for flight planning.

- ① Push , then push [ENT•WX] to select WX channel mode.
  - "WX--" and previously selected channel number appears.
- ② Rotate [DIAL] to select the desired WX channel.
- ③ Push [CLR•DEL] to exit the WX channel mode and return to frequency mode.

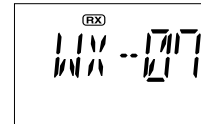

## 3 BASIC OPERATION

### ■ Receiving

- ① Push [PWR] to turn the power ON.
- ② Push [SQL•WX-ALERT], then rotate [DIAL] counterclockwise to select the squelch level 0.
- ③ Rotate [VOL] to adjust the audio level.
- ④ Push [SQL•WX-ALERT], then rotate [DIAL] clockwise until the noise is muted.
  - “**RX**” indicator disappears.
- ⑤ Set the desired frequency using [DIAL] or keypad.
- ⑥ When a signal is received on the set frequency:
  - “**RX**” indicator appears.
  - Squelch opens and audio is emitted from the speaker.

When [SQL] control is too “tight,” squelch may not open for weak signals. To receive weaker signals, loosen the squelch

### ■ Transmitting

**CAUTION:** Transmitting without an antenna may damage the transceiver.

**NOTE:** To prevent interference, listen on the frequency before transmitting. If the frequency is busy, wait until the channel is clear.

- ① Set the desired frequency in COM band using [DIAL] or keypad.
  - COM band frequency range: 118.00–136.975 MHz
- ② Push and hold [PTT] to transmit.
  - “**TX**” indicator appears.
- ③ Speak into the microphone at a normal voice level.
  - **DO NOT** hold the transceiver too close to your mouth or speak too loudly. This may distort the signal.
- ④ Release [PTT] to return to receive.

### ■ ANL function

The ANL (Automatic Noise Limiter) function reduces noise components such as that caused by engine ignition systems while receiving.

- Push [ANL•SCAN] to turn the ANL function ON/OFF. “**ANL**” appears on the display while the ANL function is ON.

## ■ Low battery indicator

Low battery indicator appears when the battery power has decreased to a specified level. The attached battery pack requires recharging.

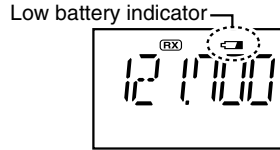

## ■ Recall function

The recall function stores the last 10 frequencies used. The function stores frequencies when the frequency is programmed and transmitted on (except memory, weather and emergency channels).

### ◇ Calling the stored frequencies

- Push to call the 1st stored frequency.
- Push to call the 10th stored frequency.



Appears recall number.

- Recall number rotation

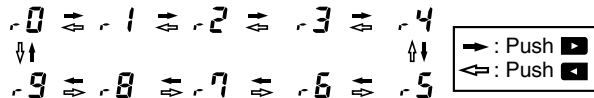

### ◇ Deletes the stored recall channel

- ① Push or to select the deleting recall channel.
- ② Push , then push [CLR•DEL] for 2 sec. to delete it.
  - (e.g.) Deletes "r0" recall channel which is stored 120.450 MHz, and "r1" recall channel stores 123.450 MHz.

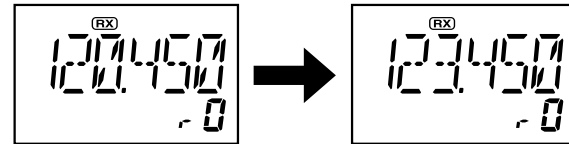

### ◇ Replaces the stored recall channel

- ① Push or to select the replacing recall channel.
- ② Push , then push or to replace it.
  - Replaces the selected channel into the previous channel when push , then .
  - Replaces the selected channel into the behind channel when push , then .
  - (e.g.) Replaces "r0" which is stored 121.375 MHz into "r1".

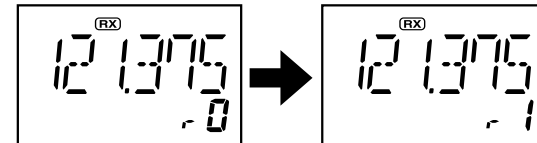

**NOTE:** Deletes in order of old recall channel automatically when stored frequencies exceeds 10 channels.

## 3 BASIC OPERATION

### ■ Setting weather alert function

An NOAA broadcast station transmits a weather alert tone before any important weather announcements. When the weather alert function is turned ON, the transceiver detects the alert, and sounds a beep tone until the transceiver is operated. The previously selected (used) weather channel is checked any time during standby, or while scanning.

- Push **[F]**, then push [SQL•WX-ALERT] to turn the weather alert function ON (Indicates “**PLT--ON**”)/OFF (Indicates “**PLT--OFF**”).

### ■ Accessing 121.5 MHz emergency frequency

The IC-A24 and IC-A6 can quickly gain access to the 121.5 MHz emergency frequency. This function can be activated even when the key lock function is in use.

- ① Push [121.5] for 2 sec. to call the emergency frequency.
- ② Push [CLR•DEL] to exit from the emergency frequency.

### ■ Lock function

The lock function prevents accidental frequency changes and accidental function activation.

- ① Push **[F]**, then push [7•**LOCK**] to turn the lock function ON.
  - “**LOCK**” appears.
- ② To turn the function OFF, repeat step ① above.
  - “**LOCK**” disappears.

### ■ Side tone function

When using an optional headset, the transceiver outputs your transmitted voice to the headset for monitoring. Connect the optional headset with the transceiver when using this function (OPC-499 HEADSET ADAPTER and headset are required).  
(p. 34)

#### ◇ Setting the side tone level

- ① Push [PTT] to turn the transmit mode ON.
- ② During transmit mode, rotate [DIAL] to adjust the monitoring level.
  - ‘ST--0’ is OFF and ‘ST--10’ is Max. level.

 **NEVER** operate the transceiver with a headset at high volume levels for long period. A ringing in your ears may occur. If so, reduce the monitor level or discontinue use.

### ■ Setting beep tone

The beep tone which sounds at the push of a switch can be set, if desired.

- ① Push **[F]**, then push [8•BEEP] to enter the beep tone setting mode.
- ② Rotate [DIAL] to set the beep level.
  - ‘BEP-- 0’ is OFF and ‘BEP-- 9’ is Max. level.
- ③ Push [CLR•DEL] to exit the beep tone set mode.

### ■ Backlighting

Push [LIGHT] to turn the display and keypad backlighting ON or OFF.



## Memory channel selection

The transceiver has 200 memory channels for storage of often-used frequencies along with 6-character notes.

- ① Push [MR•MW] to select memory mode.
  - Memory BANK number and memory CH. number appears.

### Using [DIAL]:

- ② Push [0•BANK], then rotate [DIAL] to select the desired memory BANK number, then push [0•BANK] (or [CLR•DEL]) to exit the BANK selection mode.
  - “BANK” appears.
- ③ Rotate [DIAL] to select the desired memory CH. number.
  - If no memory CH. is programmed in the selected BANK, no memory CH. selection is available.

### Using the Keypad:

- ② Push [0•BANK], then push appropriate digit key ([0•BANK] to [9•TAG]) to select the desired memory BANK number, then push [0•BANK] (or [CLR•DEL]) to exit the BANK-selection mode.
  - “BANK” appears.
- ③ Push 2 appropriate digit key (00 to 19) to select the desired memory CH. number.
  - If no memory CH. is programmed in the selected BANK, no memory CH. selection is available.

**NOTE:** Comments appear first when programmed, however, the transceiver can be programmed by your dealer to show the operating frequency first. Push [MR•MW] to display the comment in this case.

## Transferring memory contents

This function transfers a memory channel's contents into the frequency mode. This is useful when searching for signals around a memory channel's frequency.

- ① Push [MR•MW] to select memory mode.
- ② Select the desired memory channel to be transferred using [DIAL] or keypad.
- ③ Push **F**, then push [MR•MW] to transfer the memory channel's contents into the frequency mode.
  - BANK number and memory CH. number disappears as frequency mode is automatically selected and the memory contents are transferred.

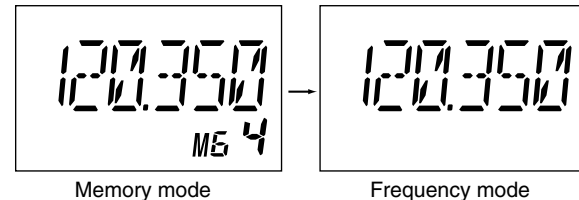

## 4 MEMORY OPERATION

### ■ Programming a memory channel

The transceiver has 200 (20 CH. × 10 BANK) memory channels for storage of often-used frequencies.

- ① Push [CLR•DEL] to select the frequency mode, if necessary.
- ② Select the desired frequency.
  - Push **F**, then push [ENT•WX] to select a weather channel.\*
  - Set the desired frequency or weather channel\* using [DIAL] or keypad.
- ③ Push **F**, then push [MR•MW] to program the contents into the selected memory channel.
  - Memory BANK and memory channel number appears.
- ④ Rotate [DIAL] to select the desired memory channel number.
  - Push **F**, then push [0•BANK] to select the BANK number if desired.
  - Push [CLR•DEL], [ENT•WX] or **F**, then push [0•BANK] to exit the BANK selection mode.
  - "M," BANK and memory numbers are blinks.
- ⑤ Push [ENT•WX] to program the information into the channel and return to the frequency mode.

\*Weather channel: U.S.A. version only.

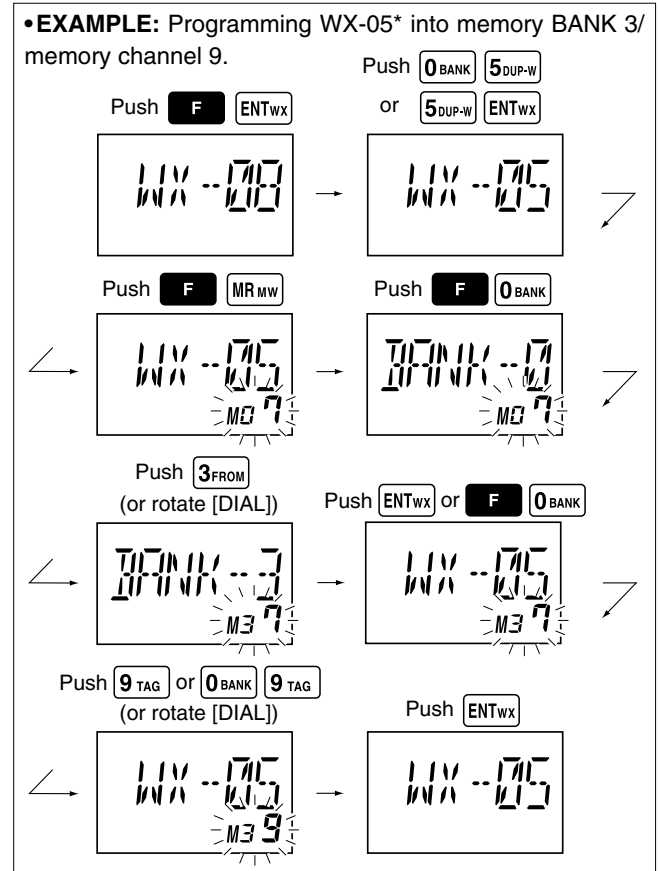

## Memory names

### ◇ Programming memory names

The memory channel can display a 6-character names instead of the programmed frequency.

- ① Rotate [DIAL] to select the desired frequency in the frequency mode.
- ② Push **F**, then push [MR•MW] to program the contents into the selected memory channel.
- ③ Rotate [DIAL] to select the desired memory channel to be programmed.
  - Push [0•BANK] to select the BANK number if desired. Push [CLR•DEL] to exit the BANK selection mode.
- ④ Push [MR•MW] to enter the memory name programming mode.
  - “- - - - -” appears on the display.
- ⑤ Push the appropriate digit key several times to select the desired character as listed at right.
  - To erase a character, overwrite with a space (displayed as \_).
  - To move the cursor forwards or backwards, use [DIAL].
- ⑥ Push [ENT•WX] to program the name.
  - Flashing the memory name stops.
  - When no name is programmed, the display shows the operating frequency.
  - To clear the programmed memory names, push [CLR•DEL] before pushing [ENT•WX].

Key	Character	Key	Character	Key	Character
1	1, Q, Z	2	2, A, B, C	3	3, D, E, F
4	4, G, H, I	5	5, J, K, L	6	6, M, N, O
7	7, P, R, S	8	8, T, U, V	9	9, W, X, Y
ENT	Program	0	0, space, -		

### Clearing the memory contents

Unwanted memory channels can be cleared. Programming over a memory channel also clears the previously programmed contents. Memory channel 1 cannot be cleared.

- ① Select the memory channel to be cleared.
- ② Push **F**, then push and hold [CLR•DEL] for 1 sec.
  - “- - - - -” appears momentarily, then the next selectable channel appears.

## 4 MEMORY OPERATION

• **EXAMPLE:** Programming 125.000 MHz into memory BANK 1/ memory channel 17 with “AIR-23” as a comment.

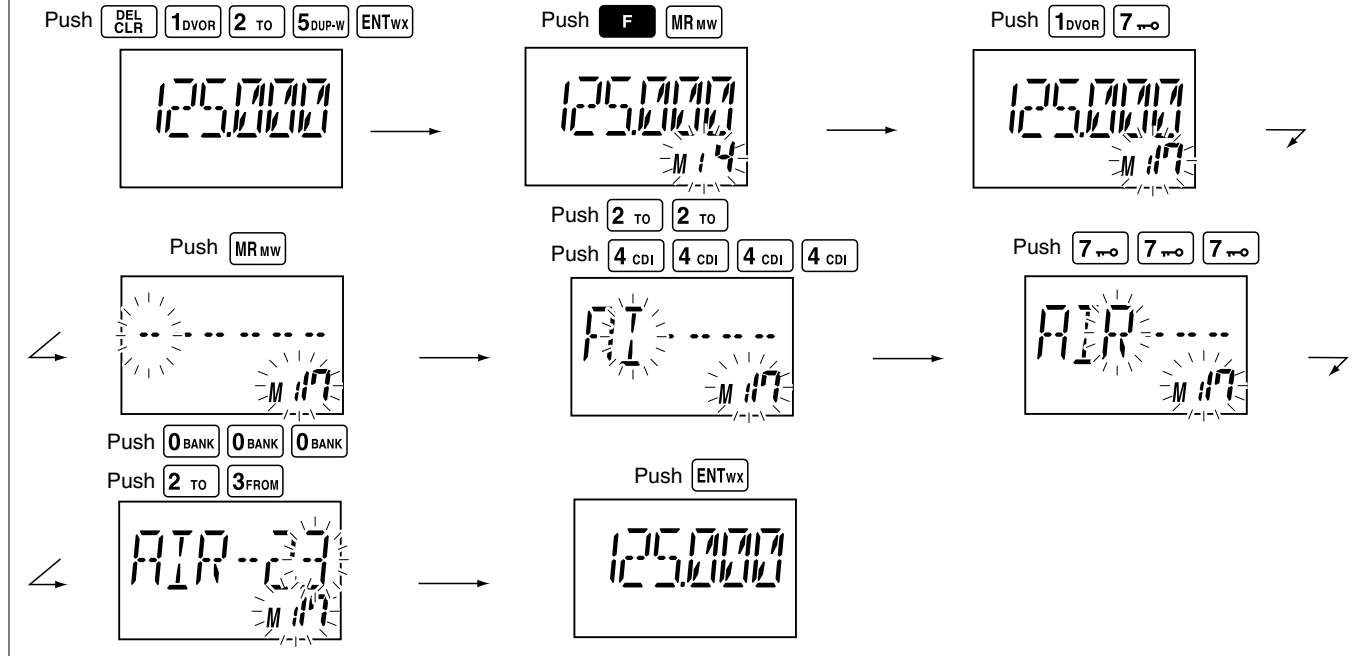

**NOTE:** Push [0•BANK], then rotate [DIAL] to select the BANK number, if desired. Push [CLR•DEL] to continue memory name programming.

## ■ Scan types

The U.S.A. version has 3 scan types to suit your needs. The non-U.S.A. versions have 2 scan types.

### COM BAND SCAN

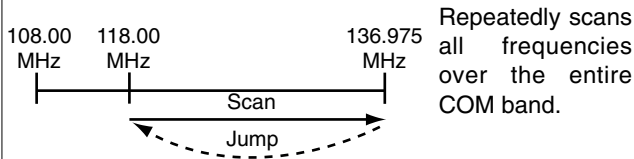

### MEMORY SCAN

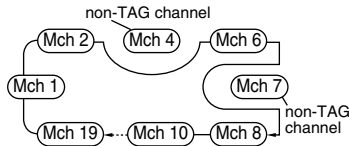

Repeatedly scans all “TAG” memory channels. Used for checking often-used channels and bypassing usually busy channels such as control-tower frequencies.

### WEATHER CHANNEL SCAN

Repeatedly scans all “TAG” weather channels. Weather channels are available for the U.S.A. version only.

## ■ COM band scan

- ① Push [CLR•DEL] to select the frequency mode.
- ② Push [SQL•WX-ALERT] to set the squelch level to the point where noise is just muted.
- ③ Push **F**, then push [ANL•SCAN] to start the scan.
  - When a signal is received, the scan pauses until it disappears.
  - To change the scanning direction, rotate [DIAL].
- ④ To stop the scan, push [CLR•DEL].

4

5

## ■ Memory scan

- ① Push [MR•MW] to select memory mode.
- ② Push [SQL•WX-ALERT] to set the squelch level to the point where noise is just muted.
- ③ Push **F**, then push [ANL•SCAN] to start the scan.
  - When a signal is received, the scan pauses until it disappears.
  - To change the scanning direction, rotate [DIAL].
- ④ To stop the scan, push [CLR•DEL].

## 5 SCAN OPERATION

### ■ Weather channel scan

(U.S.A. version only)

- ① Push **F**, then push [ENT•WX] to select a weather channel.
- ② Set squelch to the point where noise is just muted.
- ③ Push **F**, then push [ANL•SCAN] to start the scan.
  - When a signal is received, the scan pauses until it disappears.
  - To change the scanning direction, rotate [DIAL].
- ④ To stop the scan, push [CLR•DEL].

### ■ “TAG” channel setting

Memory and weather channels\* can be specified to be skipped for the memory and weather channel\* scans respectively. The “TAG” channel function is only available during scan operation.

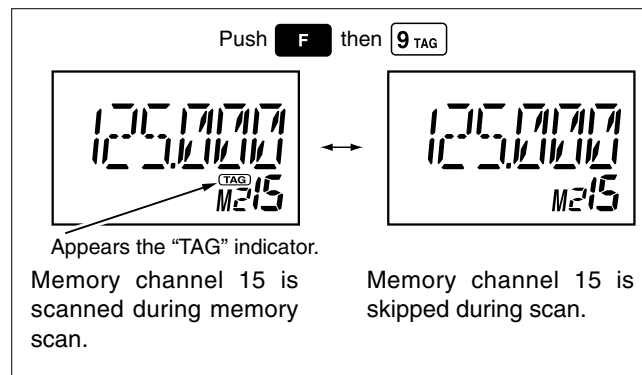

- ① Push [MR•MW] to select memory mode; or, push **F**, then push [ENT•WX] to select a weather channel.\*
- ② Select the desired memory channel to be a “TAG” channel.
- ③ Push **F**, then push [9•TAG] to set a “TAG.”
  - “TAG” appears.
  - Non-“TAG” channels are skipped during scan.
- ④ To cancel the “TAG” setting, repeat above steps.

\*Weather channel: U.S.A. version only.

## ■ VOR indicators

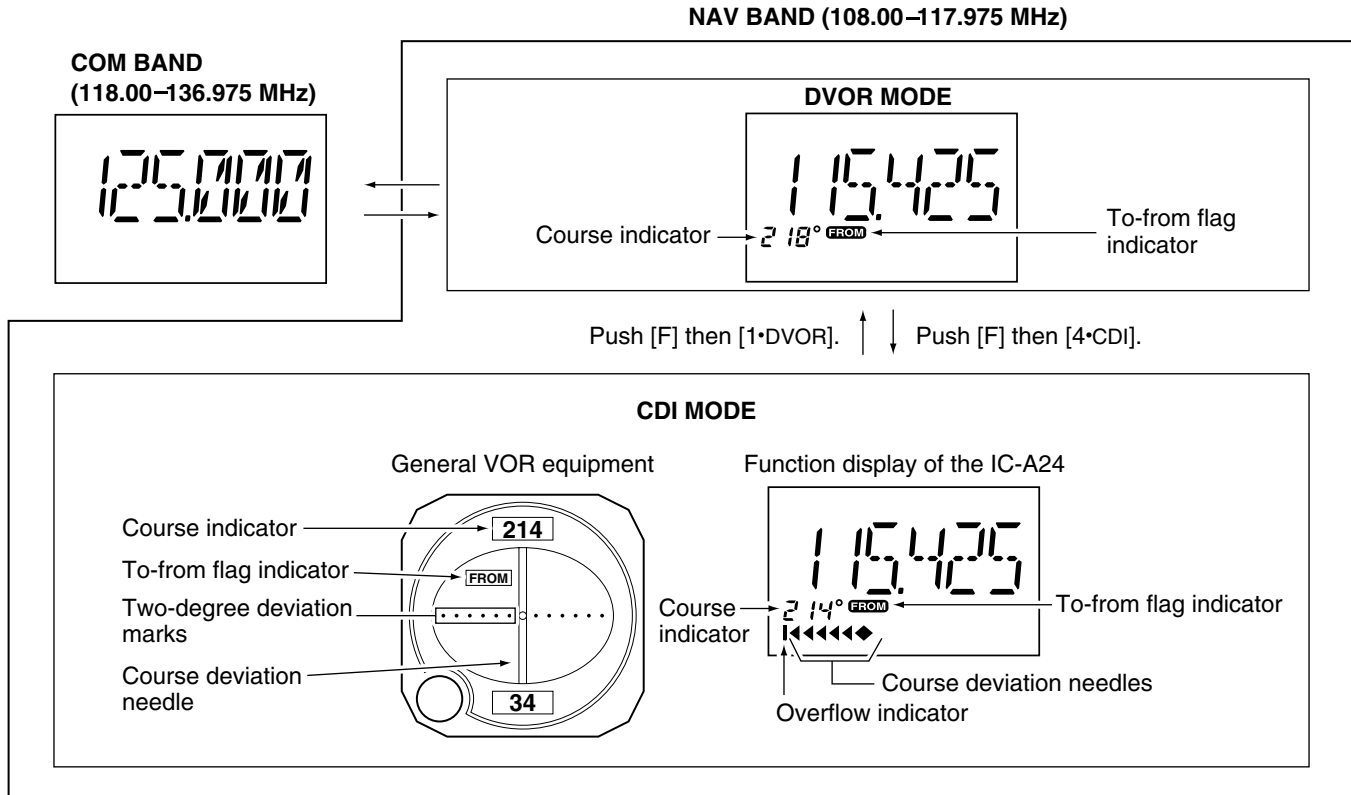

5  
6

## 6 VOR NAVIGATION (IC-A24 ONLY)

### ■ VOR functions

#### ◇ To select the CDI mode

To show the deviation between your flying course and the desired course, push **[F]**, then push **[4•CDI]** to select the CDI mode.

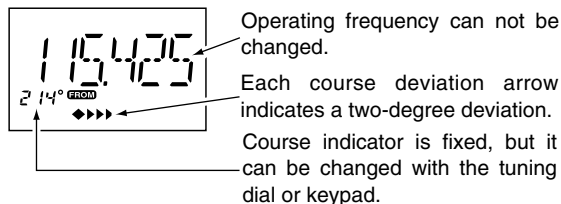

#### ◇ To select the DVOR mode

When entering the NAV band, 108.000–117.975 MHz, the IC-A24 selects the DVOR mode automatically.

To show your aircraft's direction to (or from) the VOR station, push **[F]**, then push **[1•DVOR]** to select the DVOR mode.

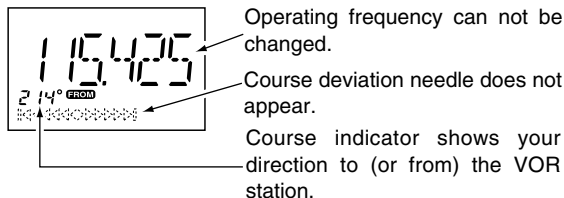

#### ◇ 'TO' or 'FROM' flag selection

The to-from flag indicators indicate whether the VOR navigation information is based on a course leading to the VOR station or leading away from the VOR station.

Push **[F]**, then push **[3•FROM]** or **[2•TO]** to change the flag from 'TO' to 'FROM' or vice versa, respectively.

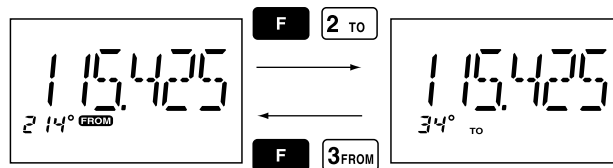

#### NOTE:

- When using the 'TO' flag and passing through the VOR station, the 'TO' flag changes to the 'FROM' flag automatically.
- When turning power ON, the 'FROM' flag is selected automatically.

#### ◇ Selecting the next VOR station when using CDI mode (when using the course deviation needle)

- ① Push **[F]**, then push **[1•DVOR]** to select the DVOR mode.
- ② Push the keypad or rotate **[DIAL]** to set the next VOR station's frequency.
- ③ Push **[F]**, then push **[4•CDI]** to select the CDI mode.
  - Select 'TO' or 'FROM' flag, if desired.



## ■ Flying to a VOR station

The IC-A24 shows the deviation from a VOR station.

- ① Select a VOR station on your aeronautical chart and push the keypad or rotate [DIAL] to set the frequency of the station.
  - The course indicator indicates where you are located on a radial from the VOR station.
  - The course indicator shows '- -' when either aircraft is too far away from the VOR station or the frequency is not set correctly at the VOR station.
- ② Select the 'TO' flag when flying to the VOR station, or select the 'FROM' flag when flying away from the VOR station.
  - Push **F**, then push [2•TO] to select 'TO'.
  - Push **F**, then push [3•FROM] to select 'FROM'.
- ③ Push **F**, then push [4•CDI] to select the CDI (Course Deviation Indicator) mode.
  - The course indicator shows 'OF' when the desired VOR signal cannot be received.

**NOTE:** When the CDI mode is selected, the operating frequency cannot be changed. To set the operating frequency, select the DVOR mode in advance.

- ④ The course deviation needle appears when your aircraft is off course from the VOR station.
  - '◀' or '▶' appears to indicate your aircraft is off course to the right or left, respectively. Correct your course until '◀' or '▶' disappears. Each arrow represents a two-degree deviation.
- ⑤ Push **F**, then push [1•DVOR] to exit the CDI mode.

### VOR INDICATOR NOTE

'loc' appears on the function display as shown below when a localizer signal is received.

However, the function display does not indicate additional information about the localizer signal.

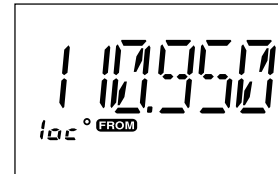

### NOTE: For U.S.A. version only

IC-A24's VOR and CDI Navigation features are supplemental aids to navigation only, and are not intended to be a substitute for accurate (primary) VOR/CDI or landing service equipment.

## 6 VOR NAVIGATION (IC-A24 ONLY)

### THE AIRCRAFT IS ON COURSE

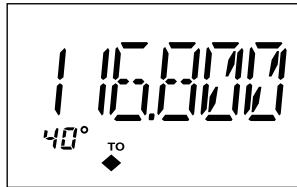

123.65  
VORTAC  
SEATTLE  
116.8 Ch 115 SEA

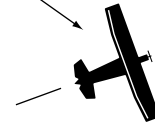

Desired course  
Aircraft heading 40°

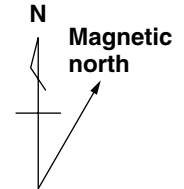
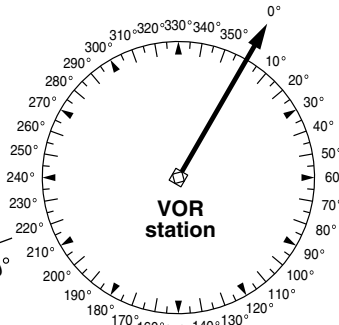

### THE AIRCRAFT IS OFF COURSE

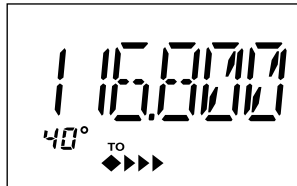

123.65  
VORTAC  
SEATTLE  
116.8 Ch 115 SEA



Aircraft heading 46°  
(6° off course)  
Flown course

Aircraft should be heading 40°

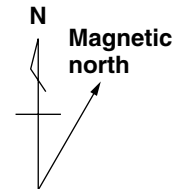
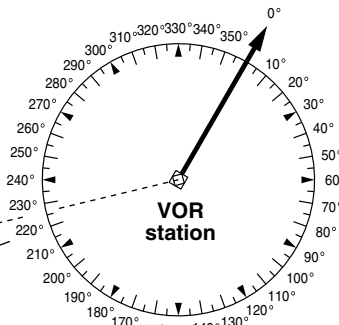

**NOTE:** The course deviation indicator appears when the aircraft is off course. In this example, the aircraft is 6 degrees off course to the left. The pilot must turn more than 6 degrees right to get back on course.

## ■ Entering a desired course

The IC-A24 shows not only the deviation from the VOR station but the deviation from the desired course.

- ① Push the keypad or rotate [DIAL] to set the frequency for the desired VOR station.
  - Push **F**, then push [2•TO] or [3•FROM] to change the to-from flag.
- ② Push **F**, then push [4•CDI] to select CDI mode.
- ③ Set the desired course to the VOR station using the tuning dial or keypad.
  - ‘◀’ or ‘▶’ appears on the function display when your aircraft is off the desired course.
  - When your heading is correct, the ABSS function (see right column for detail) may be useful instead of course input.
- ④ The course deviation needle points to the right when your aircraft is off course to the left.
  - To get back on course, fly right more than the number of degrees indicated by the CDI arrows.
  - If the overflow indicator appears on the right side, select a heading plus 10 degrees to the desired course; if the overflow indicator appears on the left side, select a heading minus 10 degrees.

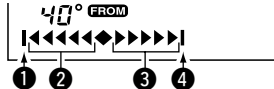

- ① Overflow indicator (left)
- ② Course deviation needles (left)
- ③ Course deviation needles (right)
- ④ Overflow indicator (right)

## ■ Crosschecking position

- ① Select 2 VOR stations on your aeronautical chart.
- ② Push the keypad or rotate [DIAL] to set the frequency of one of the VOR station in the DVOR mode.
  - The course indicator shows course deviation from the VOR radial. Note the radial you are on.
- ③ Push the keypad or rotate [DIAL] to set the frequency of the other VOR station in DVOR mode.
  - Note the radial from the station you are on.
- ④ Extend the radials from each VOR station on the chart. Your aircraft is located at the point where the lines intersect.

### ABSS FUNCTION

In the CDI mode, the Auto Bearing Set System (ABSS) adds or subtracts the number of degrees indicated by the CDI arrows from the Omni Bearing Selector (OBS).

To use ABSS, push **F**, then push [2•TO] while using the 'TO' flag; or, push **F**, then push [3•FROM] while using the 'FROM' flag.

# 6 VOR NAVIGATION (IC-A24 ONLY)

**EXAMPLE:** Entering the desired course bearing 65° to a VOR station.

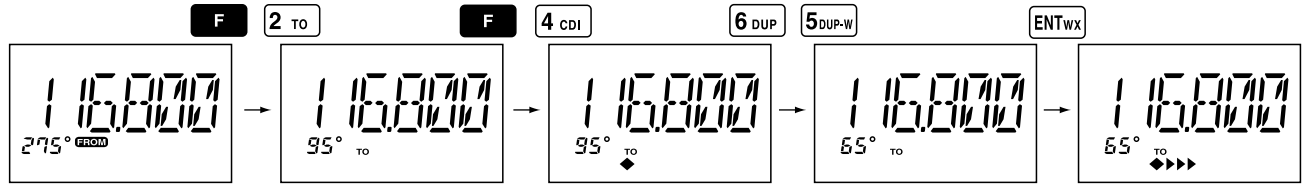

## CROSSCHECKING POSITION

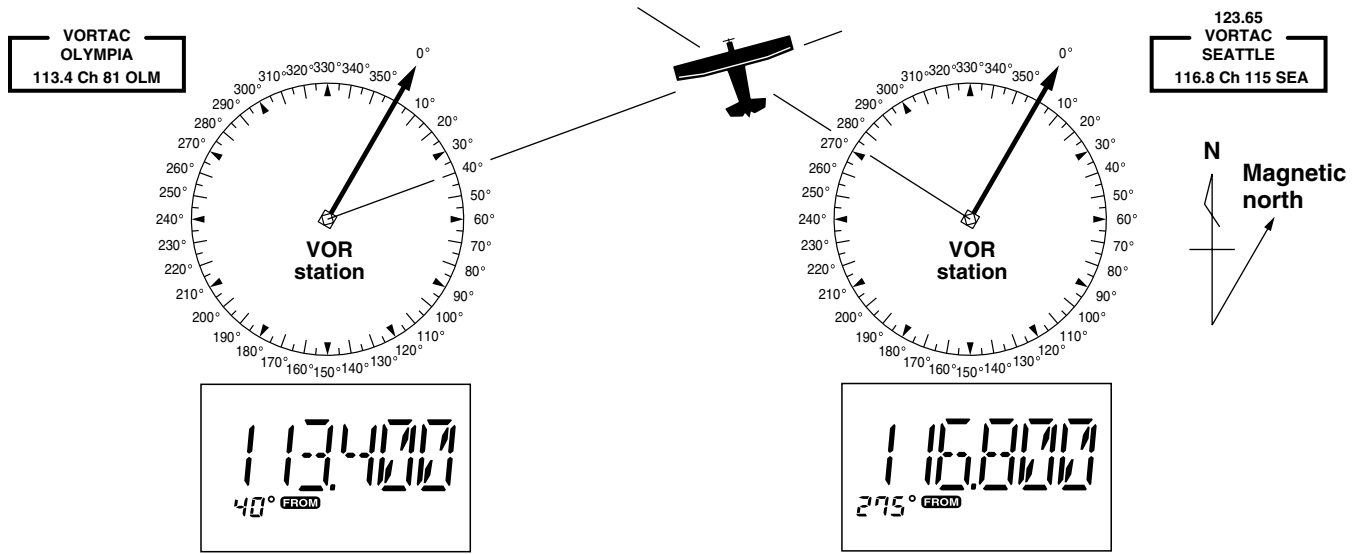

## ■ Duplex operation

(U.S.A. version only)

The duplex function allows you to call a flight service station while receiving a VOR station. The duplex function requires frequency programming for the flight service station in advance.

### ◇ Programming a duplex frequency

- ① Push [CLR•DEL] to select the frequency mode.
- ② Set a NAV band frequency using the tuning dial or keypad.
  - NAV band frequency range: 108.00–117.975 MHz
- ③ Push **F**, then push [5•DUP-W].
  - “DUP” flashes and transmit frequency appears.
- ④ Set the frequency of the flight service station using the tuning dial or keypad. When using the tuning dial, push [ENT•WX] after setting a frequency.
  - The displayed frequency returns to the NAV band frequency.

### ◇ Operating the duplex function

- ① Set the desired frequency in NAV band.
  - NAV band frequency range: 108.00–117.975 MHz
- ② Push **F**, then push [6•DUP] to turn the duplex function ON.
  - “DUP” appears on the function display.
- ③ Push and hold [PTT] to transmit at the pre-programmed transmit frequency.
- ④ Release [PTT] to return to receive.
- ⑤ Push **F**, then push [6•DUP] to cancel the function.
  - “DUP” disappears on the function display.

**NOTE:** A duplex frequency can be programmed into each memory channel independently. Set a duplex frequency before programming the memory channel, if desired. The duplex ON/OFF setting can also be programmed into a memory channel.

**EXAMPLE:** Programming 123.65 MHz as the transmit frequency in the duplex function.

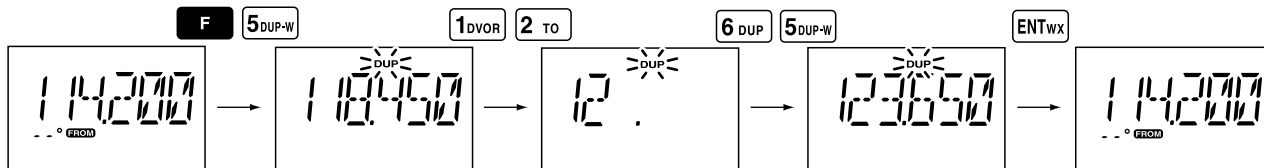

## ■ Battery charging

Prior to using the transceiver for the first time, the battery pack must be fully charged for optimum life and operation.

**CAUTION:** To avoid damage to the transceiver, turn the power OFF while charging.

- Recommended temperature range for charging:  
+10°C to +40°C (+50°F to +104°F)
- The Li-Ion battery (optional) is functioning within -20°C to +60°C (-4°F to +140°F)
- Use the supplied AC adapter on regular charging. **NEVER** use another manufacture's adapters.
- Use the specified chargers (BC-119N, BC-121N and BC-144N). **NEVER** use another manufacture's charger.

**NEVER** connect DC power to the transceiver when installing Alkaline batteries. Such a connection will damage the transceiver.

### ◇ Recycling information (U.S.A. only)



The product that you have purchased contains a rechargeable battery. The battery is recyclable. At the end of its life, under various state and local laws, it may be illegal to dispose of this battery into the municipal waste stream. Call 1-800-822-8837 for battery recycling options in your area or contact your dealer.

## ■ Battery cautions

**CAUTION! NEVER** insert battery pack/transceiver (with the battery pack attached) with wet or soiled into the charger. This may result in corrosion of the charger terminals or damage to the charger. The charger is not waterproof and water can easily get into it.

**NEVER** incinerate used battery packs. Internal battery gas may cause an explosion.

**NEVER** immerse battery pack in water. If the battery pack becomes wet, be sure to wipe it dry immediately (particularly the battery terminals **BEFORE** attaching it to the transceiver.

**NEVER** short the terminals of the battery pack. Also, current may flow into nearby metal objects, such as a necklace, etc. Therefore, be careful when carrying with, or placing near metal objects, carrying in handbags, etc.

If your battery pack seem to have no capacity even after being charged, completely discharge them by leaving the power ON overnight. Then, fully charge the battery pack again. If the batteries still do not retain a charge (or very little), new battery pack must be purchased.

Turn the transceiver power OFF when charging the battery pack. Otherwise, the battery pack may not fully charge or charge properly.

### ◆ Regular charging

- ① Attach the battery pack to the transceiver.
- ② Be sure to turn the transceiver power OFF.
- ③ Connect the Wall charger or optional cable (CP-20) as shown below.
- ④ Charging the battery pack approx. 8 hours, depending on the remaining power condition.

/// **DO NOT** charge BP-210N more than 12 hours. Otherwise, BP-210N will be damaged. BP-210N must be charged for 8–12 hours only.

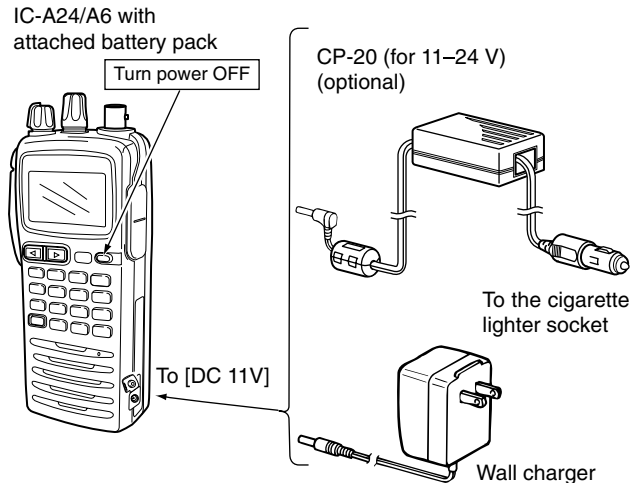

### ■ Optional battery case

When using a battery case attached to the transceiver, install 6 × AA(R6) size Alkaline batteries as illustrated below.

- ① Remove the battery case from the transceiver.
- ② Install 6 × AA(R6) size Alkaline batteries.
  - Be sure to observe the correct polarity.

#### /// CAUTION:

- When installing batteries, make sure they are all the same brand, type and capacity. Also, do not mix new and old batteries together.
- Keep battery contacts clean. It's a good idea to clean battery terminals once a week.

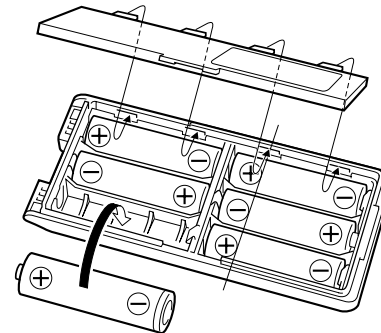

## Optional battery chargers

### ◇ Rapid charging with the BC-119N+AD-101

The optional BC-119N provides rapid charging of battery packs. The following are additionally required.

- AD-101 charger adapter.
- An AC adapter (may be supplied with BC-119N depending on versions).

**NOTE:** Attach the spacer (Spacer B/C) to the adapter (Spacer A) with orientation as illustrated below.

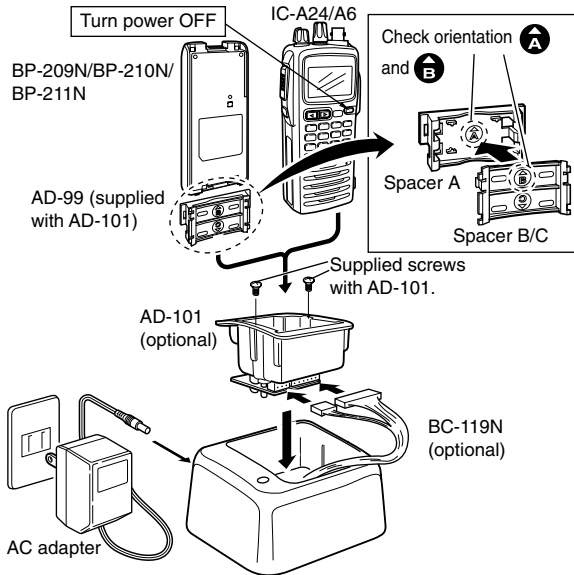

### ◇ Rapid charging with the BC-121N+AD-101

The optional BC-121N allows up to 6 battery packs to be charged simultaneously. The following are additionally required.

- Six AD-101 charger adapters.
- An AC adapter (BC-124) or the DC power cable (OPC-656).

**NOTE:** Attach the spacer (Spacer B/C) to the adapter (Spacer A) with orientation as illustrated below.

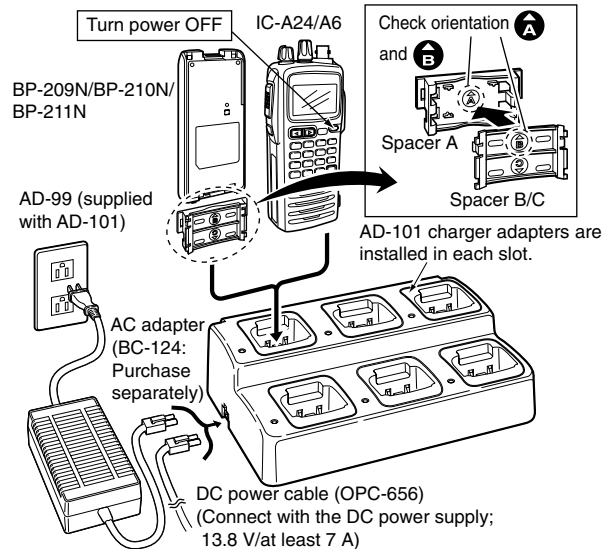



Cloning allows you to quickly and easily transfer the programmed data from one transceiver to another transceiver, or, data from PC to a transceiver using the optional CS-A24 cloning software.

## ◇ Transceiver to transceiver cloning

- ① Connect the OPC-474 CLONING CABLE with adapter plugs to [SP/MIC] jack of the master and slave transceivers.
  - The master transceiver is used to send data to the slave transceiver.

- ② While push and holding [MR•MW], push [PWR] to enter cloning mode (for operating the master transceiver only).



- "CLONE" appears and the transceivers enter the clone standby condition.

- ③ Push [MR•MW] on the master transceiver.

- "CL-OUT" appears in the master transceiver's display.

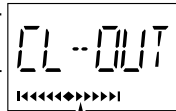

- "COURSE DEVIATION NEEDLES" shows that cloning is taking place

"COURSE DEVIATION NEEDLES" shows that cloning is taking place.

- "CL-IN" appears automatically in the slave transceiver's display.

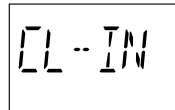

- ④ When cloning is finished, turn power OFF, then ON again to exit cloning mode.

**NOTE: DO NOT** transfer the data from IC-A24 to IC-A6, when the data contains the NAV band data. In such case, cloning error may occur.

## ◇ Cloning using PC

Data can be cloned to and from a PC (Microsoft®, Windows® 98/98SE/Me/2000/XP) using the optional CS-A24 CLONING SOFTWARE and the optional OPC-478 (RS-232C type) or OPC-478U (USB type) CLONING CABLE. Consult the CS-A24 CLONING SOFTWARE HELP file for details.

## ◇ Cloning error

**NOTE: DO NOT** push [ENT•WX] on the slave transceiver during cloning. This will cause a cloning error.

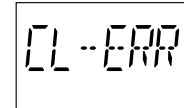

When the display at right appears, a cloning error has occurred.

In this case, both transceivers automatically return to the clone standby condition and cloning must be repeated.

Microsoft and Windows are registered trademarks of Microsoft Corporation in the U.S.A. and other countries.

# 9

## TROUBLESHOOTING

If your transceiver seems to be malfunctioning, please check the following points before sending it to a service center.

PROBLEM	POSSIBLE CAUSE	SOLUTION	REF.
No power comes on.	<ul style="list-style-type: none"> <li>• The battery is exhausted.</li> <li>• Bad connection for the battery pack.</li> </ul>	<ul style="list-style-type: none"> <li>• Recharge the battery pack.</li> <li>• Check the connection to the transceiver.</li> </ul>	pgs. 7, 25–27
No sound comes from the speaker.	<ul style="list-style-type: none"> <li>• Squelch level is too deep.</li> <li>• Volume level is too low.</li> </ul>	<ul style="list-style-type: none"> <li>• Set squelch to the threshold point.</li> <li>• Set [VOL] to a suitable level.</li> </ul>	pgs. 8, 9
Transmitting impossible.	<ul style="list-style-type: none"> <li>• Some channels are receive only.</li> <li>• The battery is exhausted.</li> </ul>	<ul style="list-style-type: none"> <li>• Change channels.</li> <li>• Recharge the battery pack.</li> </ul>	p. 8 p. 25–27
The display channel can not be selected.	<ul style="list-style-type: none"> <li>• Lock function is activated.</li> </ul>	<ul style="list-style-type: none"> <li>• Push <b>[F]</b>, then push <b>[7•M-O]</b>.</li> </ul>	p. 11
Scan does not start.	<ul style="list-style-type: none"> <li>• All memory channels are not programmed as “TAG” channels.</li> </ul>	<ul style="list-style-type: none"> <li>• Set the “TAG” settings of desired channels.</li> </ul>	p. 17
No beep sounds.	<ul style="list-style-type: none"> <li>• Beep tones turned OFF.</li> </ul>	<ul style="list-style-type: none"> <li>• Push <b>[F]</b>, then push <b>[8•BEEP]</b> to adjust the beep tone level</li> </ul>	p. 11

## ◇ General

- Frequency coverage (MHz): TX 118.000 to 136.975  
RX 108.000 to 136.975\*1  
WX 161.650 to 163.275\*2
- \*1: IC-A24 only, IC-A6; 118.000 to 136.975 MHz
- \*2: U.S.A. version only.
- Mode : 6K00A3E  
16K0G3E (161.65 to 163.275 MHz)
- Channel spacing : 25 kHz
- Number of memory channels : 200 (20 CH. × 10 BANK)
- Power supply requirement : Specified battery packs/case or  
11.0 V DC at external DC jack
- Usable temp. range : -10°C to +60°C (+14°F to +140°F)
- Current drain :  
Tx 1.5 A typical  
Rx 70 mA typical (at stand by)  
300 mA typical. (at AF max.)
- Antenna connector : BNC 50 Ω (nominal)
- Dimensions : 54(W) × 129.3(H) × 35.5(D) mm  
(projections not incl.) 2<sup>1</sup>/<sub>8</sub>(W) × 5<sup>3</sup>/<sub>32</sub>(H) × 1<sup>13</sup>/<sub>32</sub>(D) inch
- Weight : Approx. 180 g (6.35 oz)  
(Without the battery pack and antenna.)

**All stated specifications are subject to change without notice or obligation.**

## ◇ Transmitter

- Output power : 5 W (PEP) typical  
1.5 W (CW) typical
- Modulation : Low level modulation
- Modulation limiting : 70 to 100%
- Audio harmonic distortion : Less than 10% (at 60 % mod.)
- Hum and noise ratio : More than 35 dB
- Spurious emissions : More than 46 dB (except operating frequency ±6.25 Hz range)
- Microphone connector : 3-conductor 2.5(d) mm (1/10")/  
more than 100 kΩ

## ◇ Receiver

- Receive system : Double conversion  
superheterodyne
- Intermediate frequencies : 1st 30.05 MHz  
2nd 450 kHz
- Sensitivity VOR (AM 6dB S/N): Less than -3 dBμ typical  
COM (AM 6dB S/N): Less than -6 dBμ typical  
WX (FM 12dB SINAD): Less than -13 dBμ typical
- Squelch sensitivity : AM Less than 0 dBμ  
FM Less than -7 dBμ
- Selectivity : More than 7.5 kHz/-6 dB  
Less than 25 kHz/-60 dB)
- Spurious response rejection : AM More than 60 dB  
FM More than 30 dB
- Audio output power : More than 500 mW typical  
(at 10% distortion with an 8 Ω load, 30% mod.)
- Noise and hum : More than 40 dB at 30% mod.
- External SP connector : 3-conductor 3.5 (d) mm  
(1/8")/8 Ω

# 11 OPTIONS

## ◇ BATTERY CASE AND PACKS

- **BP-208N** BATTERY CASE  
Battery case for 6 × AA (R6) Alkaline cells.
- **BP-209N** Ni-Cd BATTERY PACK  
7.2 V/1100 mAh Ni-Cd battery pack.
- **BP-210N** Ni-MH BATTERY PACK  
7.2 V/1650 mAh Ni-MH battery pack.
- **BP-211N** Li-Ion BATTERY PACK  
7.4 V/1800 mAh Li-Ion battery pack.

## ◇ CHARGERS

- **BC-110AR/DR** WALL CHARGER  
The same as supplied with the transceiver.
- **BC-119N** DESKTOP CHARGER + **AD-101** CHARGER ADAPTER  
+ **BC-145** AC ADAPTER  
For rapid charging of battery packs. An AC adapter is supplied with the charger depending on versions. Charging time: approx. 1.5 to 2 hours.
- **BC-121N** MULTI-CHARGER + **AD-101** CHARGER ADAPTER (6 pcs.)  
+ **BC-124** AC ADAPTER  
For rapid charging of up to 6 battery packs (six AD-101's are required) simultaneously. An AC adapter should be purchased separately. Charging time: approx. 1.5 to 2 hours.
- **BC-144N** DESKTOP CHARGER  
For rapid charging of BP-209N (Ni-Cd) and BP-210N (Ni-MH).

## ◇ BELT CLIPS

- **MB-103** BELT CLIP  
The same as supplied with the transceiver.
- **MB-86** SWIVEL BELT CLIP  
Belt clip for swivel type.
- **MB-96F/96N** LEATHER BELT HANGER
  - ➔ MB-96F: Attaches with the supplied belt clip (Fixed type).
  - ➔ MB-96N: Belt hanger for swivel type.

## ◇ DC CABLES

- **CP-20** CIGARETTE LIGHTER CABLE
  - ➔ Charges the battery pack through a cigarette lighter socket\*.
  - ➔ Operates IC-A24/A6 through a cigarette lighter socket\*.
  - \*Both 12 V and 24 V batteries are available.
- **OPC-656** DC POWER CABLE FOR BC-121N WITH DC  
Charges the battery pack using 13.8 V power source instead of the AC adapter for BC-121N.

## ◇ OTHER OPTIONS

- **OPC-499** HEADSET ADAPTER CABLE  
When using an optional headset, such as those from the David Clark Co. via the adapter, the transceiver outputs your transmitted voice to the headset for monitoring.
- **LC-159** CARRYING CASE  
Helps protect the transceiver from scratches, etc.

Different versions of this radio use different options. Ask your authorized dealer for details.

# QUICK REFERENCE 12

Important operating instructions are summed up in this and the following page for your simple reference.

By cutting along the line and folding on the dotted line, it will become a card sized operating guide which can easily be carried in a card case or wallet, etc.

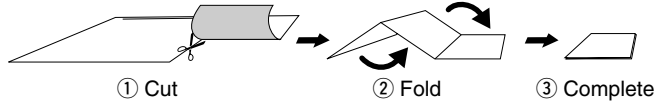

<CUT HERE>

## ICOM OPERATION GUIDE IC-A24/A6

### ■ VOR NAVIGATION (p. 22)

#### • Entering a desired course.

- 1 Push keypad or rotate [DIAL] to set the frequency for the desired VOR station.
  - Push **[F]**, then push [2•TO] or [3•FROM] to change the to-from flag.
- 2 Push **[F]**, then push [4•CDI] to select CDI mode.
  - ◀ or ▶ appears on the function display when your aircraft is off the desired course.
  - When your heading is correct, the ABSS function may be useful instead of course input.

### ■ VOR NAVIGATION (p. 20)

#### • Flying to a VOR station

- 1 Select a VOR station on your aeronautical chart and push the keypad or rotate [DIAL] to set the station's frequency.
  - Push **[F]**, then push [2•TO] to select 'TO'.
  - Push **[F]**, then push [3•FROM] to select 'FROM'.
- 2 Select the 'TO' flag when flying to the VOR station, or select the 'FROM' flag when flying away from the VOR station.
  - Push **[F]**, then push [4•CDI] to select the CDI mode.
  - The course indicator shows 'OF' when the desired VOR signal can not be received.

### ■ VOR NAVIGATION

#### • Flying to a VOR station (Continued)

- 4 The course deviation needle appears when your aircraft is off course from the VOR station.
  - 5 Push **[F]**, then push [1•DVOR] to exit the CDI mode.
- ### ■ SCAN (pgs. 16, 17)
- 1 Push [CLR•DEL], [MR•MM] or **[F]**, then [ENT•WX]\* to select the frequency, memory or WX CH\* mode.
  - 2 Push **[F]**, then push [ANL•SCAN] to start scanning.
    - Decimal point blinks during scanning.
    - Rotate [DIAL] to change the scanning direction.
  - 3 Push [CLR•DEL] to cancel the scanning.

# 12 QUICK REFERENCE

## ■ MEMORY OPERATION (p. 13)

### • Memory programming

- 1 Push [CLR+DEL] to select the frequency mode or push **F3**, then push [ENT+WX] to select WX CH\* mode.
- 2 Select the desired frequency or WX CH.\*
- 3 Push **F4**, then push [MR+MW] to enter memory programming mode.
  - "M", BANK and memory numbers blink on the display.
- 4 Rotate [DIAL] (or push keypad) to select a desired memory CH number (0 to 19).
  - Push [0+BANK], then select the BANK number if desired. Push [0+BANK] to exit the BANK selection mode.
- 5 Push [ENT+WX] to program the memory contents.

## ■ MEMORY OPERATION (p. 12)

### • Transferring memory contents

- 1 Push [MR+MW] to enter memory mode.
- 2 Select the desired channel to be transferred.
- 3 Push **F5**, then push [MR+MW];
  - BANK number and memory CH number disappears as frequency mode is automatically selected and the memory contents are transferred.

## ■ LOCK FUNCTION (p. 9)

- 1 Push **F6**. Then push [7+\*+0] to turn the key lock function ON.
  - "\*"0" appears on the display.
- 2 Push **F6**. Then push [7+\*+0] to turn the keylock function OFF.

## ■ MEMORY OPERATION (p. 14)

### • Memory BANK/CH selection

- 1 Push [MR+MW] to enter the memory CH mode.
- 2 Push **F7**, then push [0+BANK] to enter the BANK selection mode.
- 3 Push keypad (or rotate [DIAL]) to select the desired BANK number (BANK 0 to 9).
  - Push **F8**, then push [0+BANK] (or push [ENT+WX]) to set the BANK number and exit the BANK selection mode.
  - Push [CLR+DEL] to exit the BANK selection mode.

## ■ TAG CHANNELS (p. 17)

- 1 Push [MR+MW] to select the memory mode.
- 2 Push **F9**, then [9+TAG] to turn the channel "TAG" ON and OFF.

\*WX CH available U.S.A. version only.

# OPTIONAL HEADSET CONNECTION 13

## ◇ OPC-499 (HEADSET ADAPTER) connection

When using a headset, such as those from the David Clark Co. via the OPC-499 HEADSET ADAPTOR adapter, the transceiver outputs your transmitted voice to the headset for monitoring. See "■ Side tone function" (p. 11) when setting the side tone level.

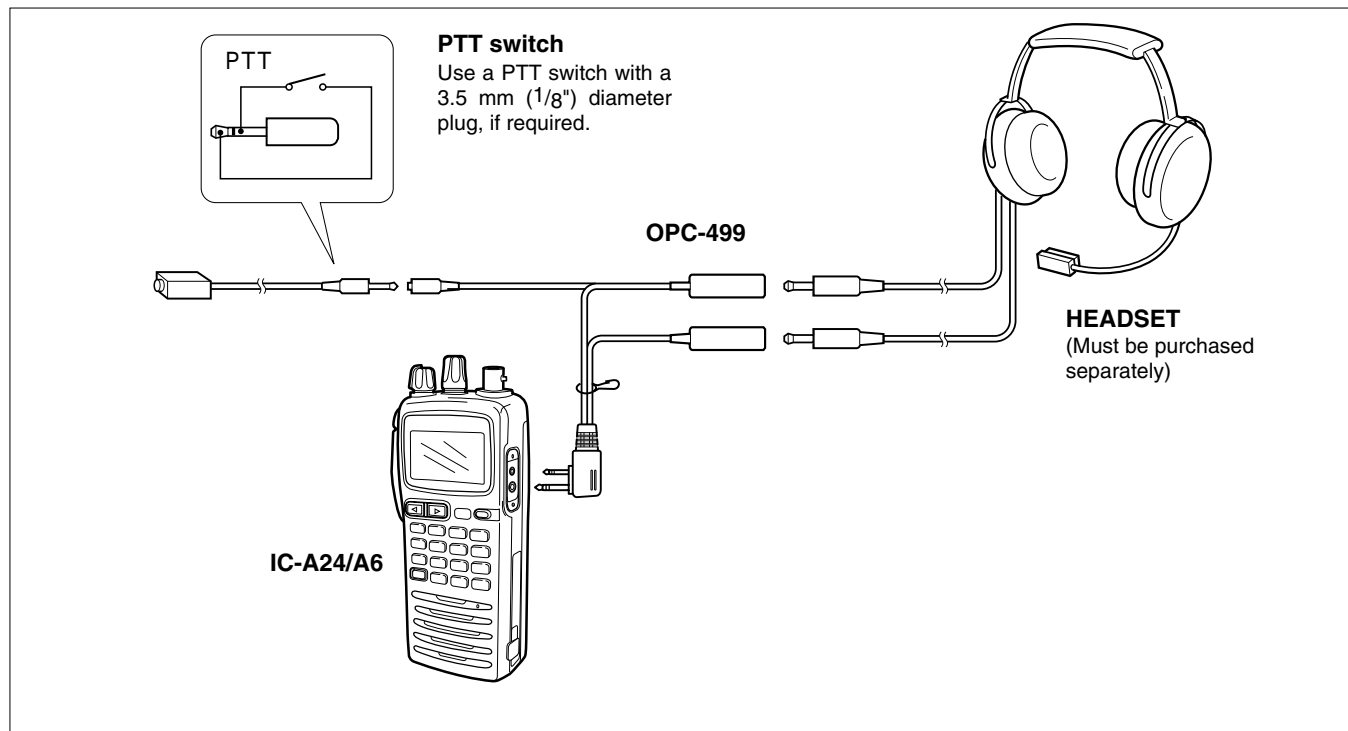

**Count on us!**

A-6403D-1EX  
Printed in Japan  
© 2004 Icom Inc.

**Icom Inc.**  
1-1-32 Kamiminami, Hirano-ku, Osaka 547-0003, Japan



## Free Manuals Download Website

<http://myh66.com>

<http://usermanuals.us>

<http://www.somanuals.com>

<http://www.4manuals.cc>

<http://www.manual-lib.com>

<http://www.404manual.com>

<http://www.luxmanual.com>

<http://aubethermostatmanual.com>

Golf course search by state

<http://golfingnear.com>

Email search by domain

<http://emailbydomain.com>

Auto manuals search

<http://auto.somanuals.com>

TV manuals search

<http://tv.somanuals.com>