



INSTRUCTION MANUAL

VHF TRANSCEIVER

IC-F3061T/S
IC-F3063T/S

UHF TRANSCEIVER

IC-F4061T/S
IC-F4063T/S

This device complies with Part 15 of the FCC Rules. Operation is subject to the condition that this device does not cause harmful interference.

Icom Inc.

Download from www.Somanuals.com. All Manuals Search And Download.



IMPORTANT

READ ALL INSTRUCTIONS carefully and completely before using the transceiver.

SAVE THIS INSTRUCTION MANUAL — This instruction manual contains important operating instructions for the **IC-F3061T/S/F3063T/S VHF TRANSCEIVERS** and **IC-F4061T/S/F4063T/S UHF TRANSCEIVERS**.

EXPLICIT DEFINITIONS

WORD	DEFINITION
⚠ WARNING	Personal injury, fire hazard or electric shock may occur.
CAUTION	Equipment damage may occur.
NOTE	If disregarded, inconvenience only. No risk of personal injury, fire or electric shock.

Icom, Icom Inc. and the  ICOM logo are registered trademarks of Icom Incorporated (Japan) in the United States, the United Kingdom, Germany, France, Spain, Russia and/or other countries.

TABLE OF CONTENTS

IMPORTANT	i	6 BATTERY CHARGING	18–22
EXPLICIT DEFINITIONS	i	■ Caution	18
TABLE OF CONTENTS	ii	■ Optional battery chargers	20
PRECAUTIONS	iii	7 BATTERY CAGE	23
1 ACCESSORIES	1–3	8 SWIVEL BELT CLIP	24–25
■ Supplied accessories	1	■ MB-93 contents	24
■ Accessory attachments	1	■ Attaching	24
2 PANEL DESCRIPTION	4–9	■ Detaching	25
■ Front panel	4	9 OPTIONS	26–28
■ Function display	6	10 SAFETY TRAINING INFORMATION	29–30
■ Programmable function keys	7		
3 BASIC OPERATION	10–11		
■ Turning power ON	10		
■ Channel selection	11		
■ Call procedure	11		
4 LTR OPERATION	12–13		
■ Receiving a call	12		
■ Transmitting a call	13		
5 CONVENTIONAL OPERATION	14–17		
■ Receiving and transmitting	14		
■ User Set mode	16		
■ Emergency transmission	16		
■ Scrambler function	16		
■ Stun function	17		
■ Priority A channel selection	17		



PRECAUTIONS

⚠ **CAUTION! NEVER** hold the transceiver so that the antenna is very close to, or touching exposed parts of the body, especially the face or eyes, while transmitting. The transceiver will perform best if the microphone is 2 to 4 in. (5 to 10 cm) away from the lips and the transceiver is vertical.

⚠ **CAUTION! NEVER** operate the transceiver with a headset or other audio accessories at high volume levels.

⚠ **CAUTION! NEVER** short the terminals of the battery pack.

DO NOT push [PTT] when not actually desiring to transmit.

AVOID using or placing the transceiver in direct sunlight or in areas with temperatures below +22°F (-30°C) or above +140°F (+60°C).

The basic operations, transmission and reception of the transceiver are guaranteed within the specified operating temperature range. However, the LCD display may not be operated correctly, or show an indication in the case of long hours of operation, or after being placed in extremely cold areas.

DO NOT modify the transceiver for any reason.

KEEP the transceiver from the heavy rain, and **Never** immerse it in the water. The transceiver construction is **water resistant**, not waterproof.

The use of non-Icom battery packs/chargers may impair transceiver performance and invalidate the warranty.

For U.S.A. only

CAUTION: Changes or modifications to this transceiver, not expressly approved by Icom Inc., could void your authority to operate this transceiver under FCC regulations.

■ Supplied accessories

The following accessories are supplied:	Qty.
① Flexible antenna	1
② Battery pack	1
③ Belt clip	1
④ Connector cover (with screw)	1 set

Some accessories are not supplied with depending on versions.

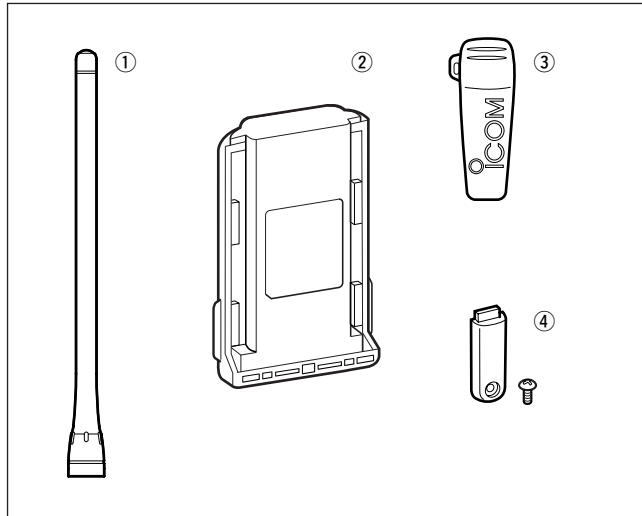

■ Accessory attachments

◇ Flexible antenna

Connect the supplied flexible antenna to the antenna connector.

CAUTION!

- **NEVER HOLD** by the antenna when carrying the transceiver.
- Transmitting without an antenna may damage the transceiver.

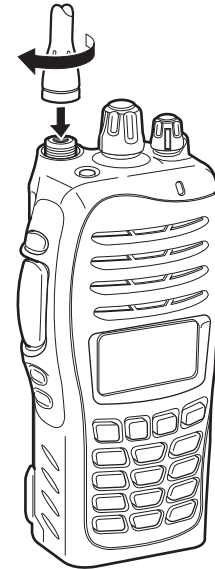

1 ACCESSORIES

◇ Battery pack

To attach the battery pack:

Slide the battery pack in the direction of the arrow (❶), then lock it with the battery release button.

- Slide the battery pack until the battery release button makes a 'click' sound.

To release the battery pack:

Slide the battery release button in the direction of the arrow (❷) as shown below. The battery pack is then released.

NEVER release or attach the battery pack when the transceiver is wet or soiled. This may result water or dust getting into the transceiver/battery pack and may result in the transceiver being damaged.

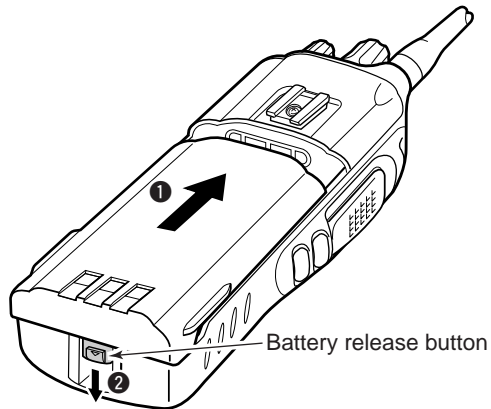

◇ Belt clip

To attach the belt clip:

- ❶ Release the battery pack if it is attached.
- ❷ Slide the belt clip in the direction of the arrow until the belt clip is locked and makes a 'click' sound.

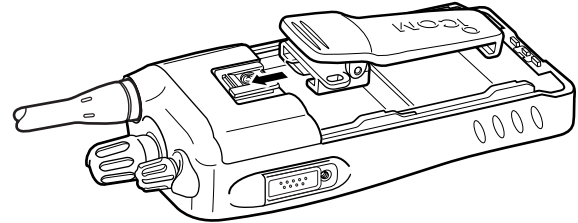

To detach the belt clip:

- ❶ Release the battery pack if it is attached.
- ❷ Pinch the clip (❶), and slide the belt clip in the direction of the arrow (❷).

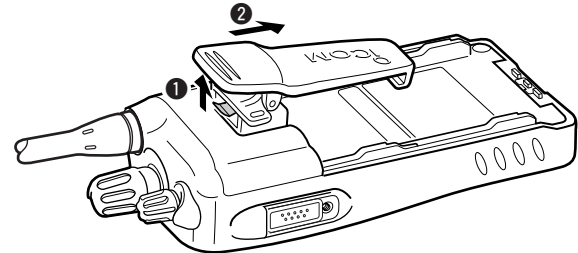

◇ Connector cover

Attach the connector cover when the optional speaker-microphone or head-set is not used.

To attach the connector cover:

- 1 Insert the connector cover into the multi-connector.
- 2 Tighten the screw.

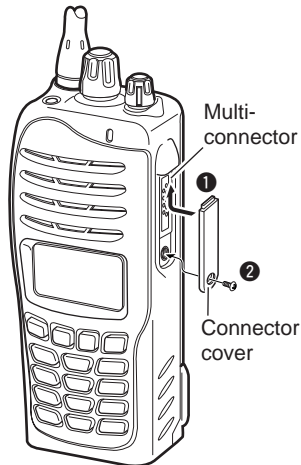

To detach the connector cover:

- 1 Unscrew the screw using a phillips screwdriver.
- 2 Detach the connector cover for the speaker-microphone or head-set connector.

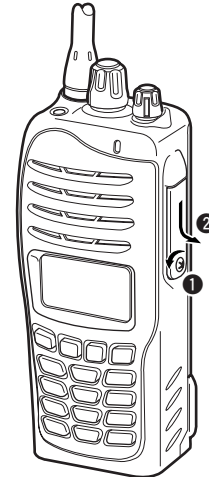

CAUTION!

Attach the connector cover when the optional speaker-microphone or head-set is not used.

Otherwise the terminals of the multi-connector may be shorted by metal object, etc., and this could damage the transceiver.

■ Front panel



1 ROTARY SELECTOR

Rotate to select the pre-programmed memory channels or the operating zone.

(Depending on the pre-setting)

2 ANTENNA CONNECTOR

Connects the supplied antenna.

3 DEALER-PROGRAMMABLE KEY [Emer]

Desired functions can be programmed by your dealer. ((☞ p. 7))

4 DEALER-PROGRAMMABLE KEY [Side1]

Desired functions can be programmed by your dealer. ((☞ p. 7))

5 PTT SWITCH [PTT]

Push and hold to transmit; release to receive.

6 DEALER-PROGRAMMABLE KEYS [Side2]/[Side3]

Desired functions can be programmed independently by your dealer. ((☞ p. 7))

7 10-KEYPAD (Depending on version)

The keypad allows you to enter digits to:

- Select memory channels
- Select tone channels
- Select DTMF codes (during transmit)
- Set TX codes
- Start up with the password

8 DEALER-PROGRAMMABLE KEYS [P0] to [P3]

Desired functions can be programmed independently by your dealer. ((☞ p. 7))

9 FUNCTION DISPLAY

Displays a variety of information such as an operating channel number/name, 2-tone code, DTMF numbers, selected function, etc.

10 MULTI-CONNECTOR

Connect an optional speaker-microphone.



Connector cover

NOTE: Attach the connector cover when the optional speaker-microphone is not used. See ((^{EST} p. 3)) for details.

11 BUSY/TRANSMIT INDICATOR

- Lights green while receiving a signal, or when the squelch is open.
- Lights red while transmitting.

12 VOLUME CONTROL [VOL]

Rotate to turn the power ON/OFF and adjusts the audio level.

2 PANEL DESCRIPTION

■ Function display

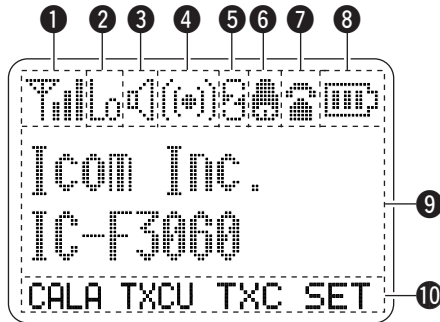

① SIGNAL STRENGTH INDICATOR

Indicates relative signal strength level.

② LOW POWER INDICATOR

Appears when low output power is selected.

③ AUDIBLE INDICATOR

- ➔ Appears when the channel is in the 'audible' (un-mute) condition.
- ➔ Appears when the specified 2-tone is received.

④ COMPANDER INDICATOR

Appears when the compander function is activated.

⑤ SCRAMBLER INDICATOR

Appears when the voice scrambler function is activated.

⑥ BELL INDICATOR

Appears/blinks when the specific 2-tone/DTMF select call is received, according to the pre-programming.

⑦ CALL CODE MEMORY INDICATOR

Appears when the call code memory is selected.

⑧ BATTERY INDICATOR

Appears or blinks when the battery power decreases to a specified level.

⑨ ALPHANUMERIC DISPLAY

- ➔ Displays an operating channel number, channel name, Set mode contents, DTMF code, etc.
- ➔ The indication mode can be selected from 1 line or 2 lines. Ask your dealer for details.
 - In this instruction manual, the LCD illustration is described using the 2 lines indication mode.

⑩ KEY INDICATOR

Indicate the programmed function of the front panel keys ([P0], [P1], [P2] and [P3]).

■ Programmable function keys

The following functions can be assigned to **[Emer]**, **[Side1]**, **[Side2]**, **[Side3]**, **[P0]**, **[P1]**, **[P2]** and **[P3]** programmable function keys.

Consult your Icom dealer or system operator for details concerning your transceivers programming.

If the programmable function names are bracketed in the following explanations, the specific key is used to activate the function depends on the programming.

CH UP AND DOWN KEYS “UP” “DOWN”

- Push to select an operating channel.
- Push to select a transmit code channel after pushing [TX Code CH Select].
- Push to select a DTMF channel after pushing [DTMF Autodial].
- Push to select a scan group after pushing and holding [Scan A Start/Stop]/[Scan B Start/Stop].

ZONE KEY “ZONE”

Push this key, then push [CH Up] or [CH Down] to select the desired zone.

What is “zone”?— The desired channels are assigned into a zone according to the intended use for grouping. For example, ‘Staff A’ and ‘Staff B’ are assigned into a “Business” zone, and ‘John’ and ‘Cindy’ are assigned into a “Private” zone.

SCAN A KEY “SCAN”

- This key’s operation depends on the Power ON Scan setting.

When the power ON scan function is turned OFF;

Push to start and cancel scanning operation. In case of transmission during scan, cancels scanning.

When the power ON scan function is turned ON;

Push to pause scanning., then resumes scanning after passing a specified time period. In case of transmission during scan, scanning will be cancelled.

- Push and hold this key for 1 sec. to indicate the scan group, then push [CH Up] or [CH Down] to select the desired group.

SCAN B KEY “SCNB”

- Push to start and cancel scanning operation. In case of transmission during scan, pauses scanning. Scanning resumes after passing a specified time period.
- Push and hold this key for 1 sec. to indicate the scan group, then push [CH Up] or [CH Down] to select the desired group.

2 PANEL DESCRIPTION

SCAN ADD/DEL (TAG) KEY "SCAD"

Push to add or delete the selected channel to/from the scan group.

PRIO A/B KEYS "PRA" "PRAR" "PRB" "PRBR"

- ➔ Push to select Priority A or Priority B channel.
- ➔ Push and hold [Prio A (Rewrite)] to rewrite the Prio A channel.

MR-CH 1/2/3/4 KEYS "CH1" "CH2" "CH3" "CH4"

Push to select an operating channel directly.

MONI KEY "MON"

Mute and release the CTCSS (DTCS) or 2-tone squelch mute. Open any squelch/deactivate any mute while pushing this key.

LIGHT KEY "LIGT"

Push to turn the transceiver's backlight ON temporarily only when the backlight function is turned OFF in user set mode.

LOCK KEY "LOCK"

- ➔ Push and hold for 1 sec. to electronically lock all programmable keys except the following:
[Call] (incl. Call A and Call B), [Moni(Audi)] and [Emergency].
- ➔ Push and hold for 1 sec. again to turn the lock function OFF.

HIGH/LOW KEY "H/L"

Push to select the transmit output power temporarily or permanently, depending on the pre-setting.

- Ask your dealer for the output power level for each selection.

C.TONE CH ENT KEY "TSEL"

Push to select the continuous tone channel using [CH Up]/[CH Down] to change the tone frequency/code setting. The selected channel remains set as the continuous tone channel until another channel is designated as such.

TALK AROUND KEY "TA"

Push to turn the talk around function ON and OFF.

- The talk around function equalizes the transmit frequency to the receive frequency for transceiver-to-transceiver communication.

WIDE/NARROW KEY "W/N"

Push to toggle the IF bandwidth between wide and narrow.

DTMF AUTODIAL KEY "DTMA"

- ➔ Push to enter the DTMF channel selection mode. Then select the desired DTMF channel using [CH Up]/[CH Down].
- ➔ After selecting the desired DTMF channel, push this key to transmit the DTMF code.

RE-DIAL KEY "DTMR"

Push to transmit the last-transmitted DTMF code.

CALL KEYS “CALL” “CALA” “CALB”

Push to transmit a 2-tone.

- Call transmission is necessary before you call another station depending on your signaling system.
- [Call A] and/or [Call B] may be available when your system employs selective ‘Individual/Group’ calls. Ask your dealer which call is assigned to each key.

EMERGENCY KEY “EMR”

Push and hold for a specified period to transmit an emergency call.

- If you want to cancel the emergency call, push (or push and hold) the key again before transmitting the call.
- The emergency call is transmitted one time only or repeatedly until receiving a control code depending on the pre-setting.

SURVEILLANCE KEY “SURV”

Push to turn the surveillance function ON or OFF.

When this function is turned ON, the beep is not emitted and the LCD backlight does not light when a signal is received or a key is pushed, etc.

TX CODE CHANNEL SELECT KEY “TXC”

- Push to enter the ID code channel selection mode directly. Then set the desired channel using [CH Up]/[CH Down]. (☞ p. 15)

TX CODE CHANNEL UP/DOWN KEYS “TXCU” “TXCD”

Push to select a TX code channel directly.

SCRAMBLER FUNCTION “SCR”

Push to toggle the voice scrambler function ON and OFF.

COMPANDER KEY “COMP”

Push to toggle the compander function ON and OFF.

The compander function reduces noise components from the transmitting audio to provide clear communication.

PHONE KEY “PHN”

Push to connect or disconnect the telephone network connection during LTR operation.

USER SET MODE KEY “SET”

- Push and hold to enter user set mode.
 - During user set mode, push this key to select an item, and change the value or condition using push [CH Up]/[CH Down].
- Push and hold this key again to exit user set mode.

User set mode is also available via the ‘Power ON function.’ Refer to (☞ p. 16) also.

OPT OUT KEYS “OP1” “OP2” “OP3”

Push to control the output signal level of the optional ports in the optional unit connector.

OPT MOMENTARY KEYS “O1M” “O2M” “O3M”

Push and hold to control the output signal level of the optional ports in the optional unit connector.

■ Turning power ON

▨ Prior to using the transceiver for the first time, the battery pack must be fully charged for optimum life and operation. ((p. 20))

- ① Rotate [VOL] to turn the power ON.
- ② If the transceiver is programmed for a start up password, input the digit codes as directed by your dealer.
 - 10-keypad can be used for password input depending on version:
 - The keys in the table below can be used for password input:
 - The transceiver detects numbers in the same block as identical. Therefore "01234" and "56789" are the same.

KEY	P ₀	P ₁	P ₂	P ₃	(Side3)
NUMBER	0	1	2	3	4
	5	6	7	8	9

- ③ When the "PASSWORD" indication does not clear after inputting 4 digits, the input code number may be incorrect. Turn the power off and start over in this case.

◇ Battery type selection

The battery type must be selected according to the attaching battery type when tuning the transceiver ON..

- ➔ While pushing and holding [Emer] and [PTT], rotate [VOL] to toggle the attaching battery type.
 - After the display appears, release [Emer] and [PTT].
 - "DRY BATT" is displayed for about 3 sec. then "Lo" appears when the battery case operation is selected.
 - "LI-ION" is displayed for about 3 sec. when the Lithium-ion battery operation is selected.
- This operation may not be available depending on the pre-setting. Ask your dealer for details.

■ Channel selection

Several types of channel selections are available. Methods may differ according to your system set up.

NON-ZONE TYPE:

Push [CH Up] or [CH Down], or rotate [ROTARY SELECTOR]* to select the desired operating channel, in sequence; or, push one of [MR-CH 1] to [MR-CH 4] keys to select a channel directly.

- Up to 16 pre-programmed channels can be selected via [ROTARY SELECTOR].*

ZONE TYPE:

Push [Zone], then push [CH Up] or [CH Down] or rotate [ROTARY SELECTOR]* to select the desired zone.

AUTOMATIC SCAN TYPE:

Channel setting is not necessary for this type. When turning power ON, the transceiver automatically starts scanning. Scanning stops when receiving a call.

*Depending on the pre-setting.

■ Call procedure

When your system employs tone signaling (excluding CTCSS and DTCS), the call procedure may be necessary prior to voice transmission. The tone signaling employed may be a selective calling system which allows you to call specific station(s) only and prevent unwanted stations from contacting you.

- ① Select the desired TX code channel or 2-tone code according to your System Operator's instructions.
 - This may not be necessary depending on programming.
 - Refer to ((pages 14 or 15)) for selection.
- ② Push the call key (assigned to one of the dealer programmable keys: [Emer], [Side1], [Side2], [Side3], [P0], [P1], [P2] and [P3]) or [PTT].
- ③ After transmitting a 2-tone code, the remainder of your communication can be carried out in the normal fashion.

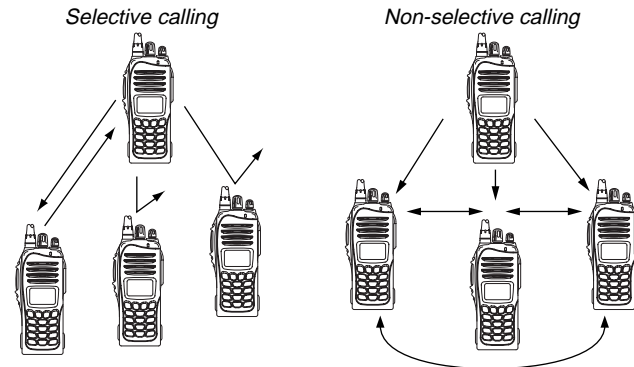

■ Receiving a call

◇ Group call

- ① Push [CH Up] or [CH Down], or rotate [ROTARY SELECTOR]* to select the LTR system channel or talk group.
- ② When a call is received;
 - 'BUSY' indicator lights green.
- ③ Push and hold [PTT], then speak into the microphone at a normal voice level.
- ④ Release [PTT] to return to receive.

◇ Selective call (DTMF call)

- ① Push [CH Up] or [CH Down], or rotate [ROTARY SELECTOR]* to select the LTR system channel or talk group.
- ② Push [Call] to mute the channel.
- ③ When receiving a call, the calling station name appears and a beep is emitted. Then the mute is released.
 - "📞" appears.

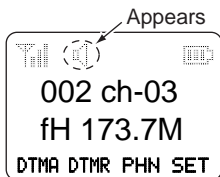

◇ Phone call

• Receive a phone call

- ① Push [CH Up] or [CH Down], or rotate [ROTARY SELECTOR]* to select the phone channel of LTR system channel.
 - "📞" appears.
- ② When a phone call is received (transceiver rings), push [PHONE] (or push [PTT]).
 - "📞" blinks.

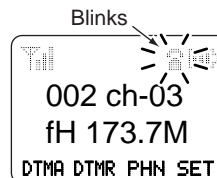

- ③ Push and hold [PTT], then speak into the microphone at a normal voice level. Release [PTT] to return to receive.
- ④ After conversation is finished, push [PHONE] (or while pushing and holding [PTT], push [#]) to disconnect the phone call.
 - "📞" stops blinking.

*:Depending on the pre-setting.

• Make a phone call

- ① Select the phone channel of LTR system channel.
 - “☎” appears.
- ② Push [PHONE] (or push [PTT]).
 - “☎” blinks.

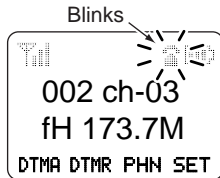

- ③ Push [DTMF Autodial] (or while pushing and holding [PTT] enter the desired telephone number using 10 key pad) to make a phone call.
- ④ After conversation is finished, push [PHONE] (or while pushing and holding [PTT], push [#]) to disconnect the phone call.
 - “☎” stops blinking.

*:Depending on the pre-setting.

■ Transmitting a call

◇ Group call

- ① Push [CH Up] or [CH Down], or rotate [ROTARY SELECTOR]* to select the LTR system channel or talk group.
- ② While pushing and holding [PTT], speak into the microphone at a normal voice level after a beep is emitted.
 - If an error beep is emitted, release [PTT]. After a while, repeat step ②.
 - The beep can be turned OFF in User set mode.

◇ Selective call (DTMF call)

- ① Push [CH Up] or [CH Down], or rotate [ROTARY SELECTOR]* to select the LTR system channel or talk group.
- ② Push [DTMF Autodial]— a DTMF encode channel appears.
- ③ Push [CH Up] or [CH Down] to select the desired DTMF encode channel.
- ④ Push [PTT] to transmit the selected DTMF code in the selected DTMF channel.
 - Push [DTMF Autodial] to cancel the DTMF transmission.

■ Receiving and transmitting

NOTE: Transmitting without an antenna may damage the transceiver. See ((p. 1)) for accessory attachments.

Receiving:

- ① Rotate [VOL] to turn the power ON.
- ② Push [CH Up] or [CH Down], or rotate [ROTARY SELECTOR]* to select the conventional system channel, in sequence.
*Depending on the pre-setting.
- ③ When receiving a call, adjust the audio output level to a comfortable listening level.

Transmitting:

Wait for the channel to become clear to avoid interference.

- ① Push [Call] when initiating a call from your side.
 - Coded audio may be heard from the transceiver, then “◀” appears.
 - This operation may not be necessary depending on your signaling system. Ask your dealer for details.
- ② While pushing and holding [PTT], speak into the microphone at a normal voice level.
- ③ Release [PTT] to return to receive.

IMPORTANT: To maximize the readability of your signal;

1. Pause briefly after pushing [PTT].
2. Hold the microphone 5 to 10 cm (2 to 4 inches) from your mouth, then speak into the microphone at a normal voice level.

◇ **Transmitting notes**

• **Transmit inhibit function**

The transceiver has several inhibit functions which restrict transmission under the following conditions:

- The channel is in mute condition ('Inaudible' condition; “◀” does not appear.)
- The channel is busy.
- Un-matched (or matched) CTCSS is received.
(Depending on the pre-setting.)
- The selected channel is a 'receive only' channel.

• **Time-out timer**

After continuous transmission for the pre-programmed time period, the time-out timer is activated, causing the transceiver to stop transmitting.

• **Penalty timer**

Once the time-out timer is activated, transmission is further inhibited for a period determined by the penalty timer.

◇ TX code channel selection

If the transceiver has [TX Code CH Select] assigned to it, the indication can be toggled between the operating channel number (or name) and TX code channel number (or name). When the TX code channel number (or name) is displayed, [CH Up] or [CH Down] selects the TX code channel.

USING [TX CODE CH SELECT] KEY:

- ① Push [TX Code CH Select]— a TX code channel number (or name) appears.
- ② Push [CH Up] or [CH Down] to select the desired TX code channel.
- ③ Push [Call] (or [PTT] during MSK operation) to transmit the selected TX code.
- ④ Push [TX Code CH Select] again to return to the operating channel number indication.

USING [TX CODE CH UP]/[TX CODE CH DOWN] KEY:

If the transceiver has a [TX Code CH Up] or [TX Code CH Down] key assignment, the programmed TX code channel can be selected directly when pushed.

◇ DTMF transmission

If the transceiver has [DTMF Autodial] assigned to it, the automatic DTMF transmission function is available. Up to 8 DTMF channels are available.

TO SELECT A TX CODE:

- ① Push [DTMF Autodial]— a DTMF channel appears.
- ② Push [CH Up] or [CH Down] to select the desired DTMF channel.
- ③ Push [DTMF Autodial] to transmit the DTMF code in the selected DTMF channel.

5 CONVENTIONAL OPERATION

■ User set mode

User set mode is accessed at power ON and allows you to set seldom-changed settings. In this case you can “customize” the transceiver operation to suit your preferences and operating style.

Entering the user set mode:

- ① While pushing and holding [P1] and [P2], rotate [VOL] to turn the power ON. Then, push and hold [P0] to enter user set mode.
- ② Push [P0] several times to select the appropriate item. Then push [Side2] or [Side3] to set the desired level/condition.
 - Available set mode functions are **Backlight**, **LCD contrast**, **Beep**, **Beep Level**, **Ringer Level**, **SQL Level**, **AF Min Level**, **Mic Gain**, **VOX Gain**, **VOX Delay**, **Battery Voltage** and **Signal Moni**.
- ③ Rotate [VOL] to turn the power OFF to exit user set mode.

 **NOTE:** User set mode is also available via a programmable key. Please refer to ((p. 9)) [User Set Mode] section.

■ Emergency transmission

When [Emergency Single] or [Emergency Repeat] is pushed, an emergency signal is automatically transmitted for the specified time period.

When [Emergency] is pushed, the DTMF emergency signal is transmitted on the priority channel.

When [Emergency Single] or [Emergency Repeat] is pushed for the specified time period, the DTMF emergency signal is transmitted once or repeatedly on the emergency channel. However, when no emergency channel is specified, the signal is transmitted on the previously selected channel.

■ Scrambler function

The voice scrambler function provides private communication between stations. The frequency inversion type is equipped to all versions, moreover, the optional Rolling or Non-rolling type can be available.

- ① Push [Scrambler] to turn the scrambler function ON.
 - “G” appears.
- ② Push [Scrambler] again to turn the scrambler function OFF.
 - “G” disappears.

■ Stun function

When the specified ID, set as a killer ID, is received, the stun function is activated.

When the killer ID is received, the transceiver switches to the password required condition. Entering of the password via the keypad is necessary to operate the transceiver again in this case.

■ Priority A channel selection

When one of the following operations is performed, the transceiver selects the Priority A channel automatically.

Priority A is selected when;

- Clear down signal is received/transmitted
 - Set the 'Move to PrioA CH' item as 'Clear down.'
- Turning the power ON
 - The Priority A channel is selected each time the transceiver power is turned ON.
- Status call
 - The Priority A channel is selected when transmitting a status call.

■ Caution

Misuse of LITHIUM-ION batteries may result in the following hazards: smoke, fire, or the battery may rupture. Misuse can also cause damage to the battery or degradation of battery performance.

- **⚠ DANGER!** Use and charge only specified Icom battery packs with Icom radios or Icom charger. Only Icom battery packs are tested and approved for use and charge with Icom radios or Icom charger. Using third-party or counterfeit battery packs or charger may cause smoke, fire, or cause the battery to burst.

◆ Battery caution

- **⚠ DANGER! DO NOT** hammer or otherwise impact the battery. Do not use the battery if it has been severely impacted or dropped, or if the battery has been subjected to heavy pressure. Battery damage may not be visible on the outside of the case. Even if the surface of the battery does not show cracks or any other damage, the cells inside the battery may rupture or catch fire.

- **⚠ DANGER! NEVER** use or leave battery packs in areas with temperatures above +60°C (+140°F). High temperature buildup in the battery, such as could occur near fires or stoves, inside a sun heated car, or in direct sunlight may cause the battery to rupture or catch fire. Excessive temperatures may also degrade battery performance or shorten battery life.
- **⚠ DANGER! DO NOT** expose the battery to rain, snow, seawater, or any other liquids. Do not charge or use a wet battery. If the battery gets wet, be sure to wipe it dry before using. The battery is not waterproof.
- **⚠ DANGER! NEVER** incinerate used battery packs since internal battery gas may cause them to rupture, or may cause an explosion.
- **⚠ DANGER! NEVER** solder the battery terminals or NEVER modify the battery pack. This may cause heat generation, and the battery may rupture, emit smoke or catch fire.
- **⚠ DANGER!** Use the battery only with the transceiver for which it is specified. Never use a battery with any other equipment, or for any purpose that is not specified in this instruction manual.
- **⚠ DANGER!** If fluid from inside the battery gets in your eyes, blindness can result. Rinse your eyes with clean water, without rubbing them, and see a doctor immediately.

- **WARNING!** Immediately stop using the battery if it emits an abnormal odor, heats up, or is discolored or deformed. If any of these conditions occur, contact your Icom dealer or distributor.
- **WARNING!** Immediately wash, using clean water, any part of the body that comes into contact with fluid from inside the battery.
- **WARNING! NEVER** put the battery in a microwave oven, high-pressure container, or in an induction heating cooker. This could cause a fire, overheating, or cause the battery to rupture.
- **CAUTION!** Always use the battery within the specified temperature range for the transceiver (−30°C to +60°C; −22°F to +140°F) and the battery itself (−20°C to +60°C; −4°F to +140°F). Using the battery out of its specified temperature range will reduce the battery's performance and battery life.
- **CAUTION!** Shorter battery life could occur if the battery is left fully charged, completely discharged, or in an excessive temperature environment (above +45°C; +113°F) for an extended period of time. If the battery must be left unused for a long time, it must be detached from the radio after discharging. You may use the battery until the battery indicator shows half-capacity, then keep it safely in a cool dry place with the temperature between −20°C to +25°C (−4°F to +77°F).

◇ Charging caution

- **⚠ DANGER! NEVER** charge the battery pack in areas with extremely high temperatures, such as near fires or stoves, inside a sun heated car, or in direct sunlight. In such environments, the safety/protection circuit in the battery will activate, causing the battery to stop charging.
- **WARNING! DO NOT** charge or leave the battery in the battery charger beyond the specified time for charging. If the battery is not completely charged by the specified time, stop charging and remove the battery from the battery charger. Continuing to charge the battery beyond the specified time limit may cause a fire, overheating, or the battery may rupture.
- **WARNING! NEVER** insert the transceiver (battery attached to the transceiver) into the charger if it is wet or soiled. This could corrode the battery charger terminals or damage the charger. The charger is not waterproof.
- **CAUTION! DO NOT** charge the battery outside of the specified temperature range: BC-160 (0°C to +45°C; +32°F to +113°F). Icom recommends charging the battery at +20°C (+68°F). The battery may heat up or rupture if charged out of the specified temperature range. Additionally, battery performance or battery life may be reduced.

6 BATTERY CHARGING

■ Optional battery chargers

◆ Rapid charging with the BC-160

The optional BC-160 provides rapid charging of optional Li-Ion battery packs.

- An AC adapter (may be supplied with BC-160 depending on version) or the DC power cable (OPC-515L/CP-17L) is additionally required.

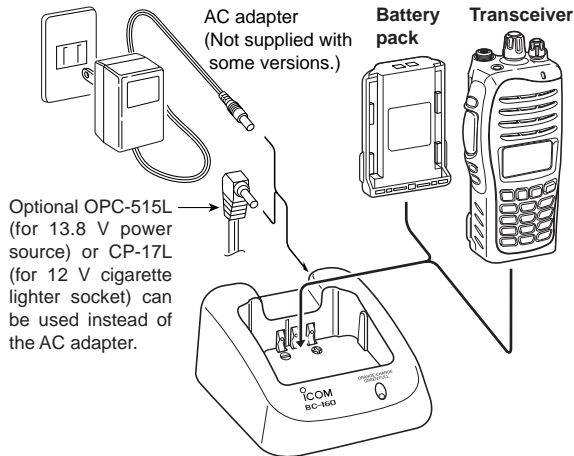

◆ AD-106 installation

- ① Install the AD-106 desktop charger adapter into the holder space of the BC-119N/BC-121N.
- ② Connect the plugs of the BC-119N/BC-121N to the AD-106 desktop charger adapter with the connector, then install the adapter into the charger with the supplied screws.

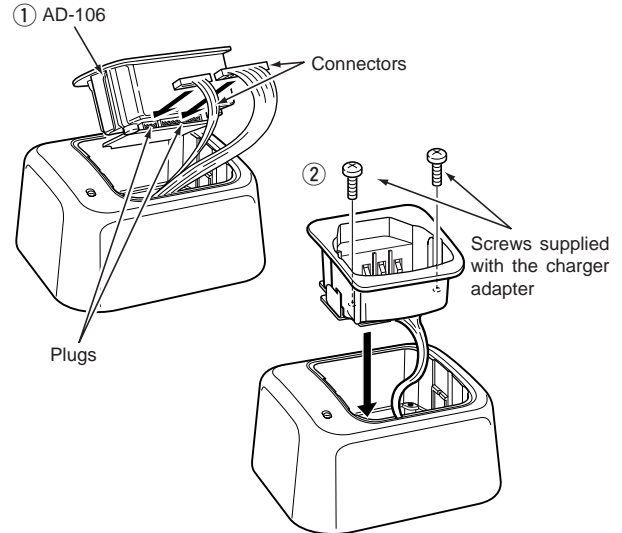

◇ **Rapid charging with the BC-119N+AD-106**

The optional BC-119N provides rapid charging of battery packs. The following items are additionally required.

- AD-106 charger adapter
- An AC adapter (may be supplied with BC-119N depending on version) or the DC power cable (OPC-515L/CP-17L).

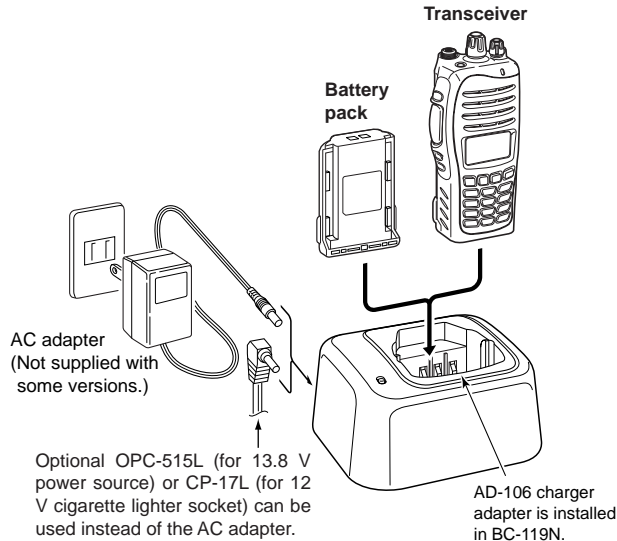

◇ **Rapid charging with the BC-121N+AD-106**

The optional BC-121N allows up to 6 battery packs to be charged simultaneously. The following items are additionally required.

- Six AD-106 charger adapters
- An AC adapter (BC-157) or the DC power cable (OPC-656)

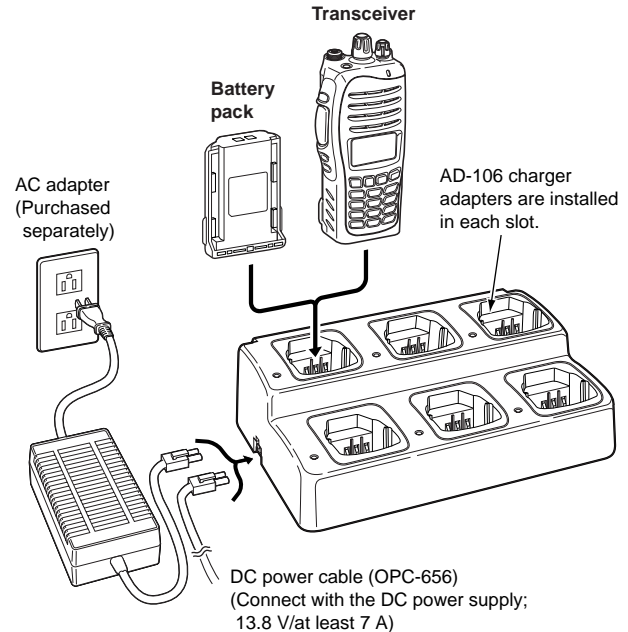

6 BATTERY CHARGING

IMPORTANT!: Battery charging caution

Ensure the guide lobs on the battery pack are correctly aligned with the guide rails inside the charger adapter.
(This illustration is described with the BC-160.)

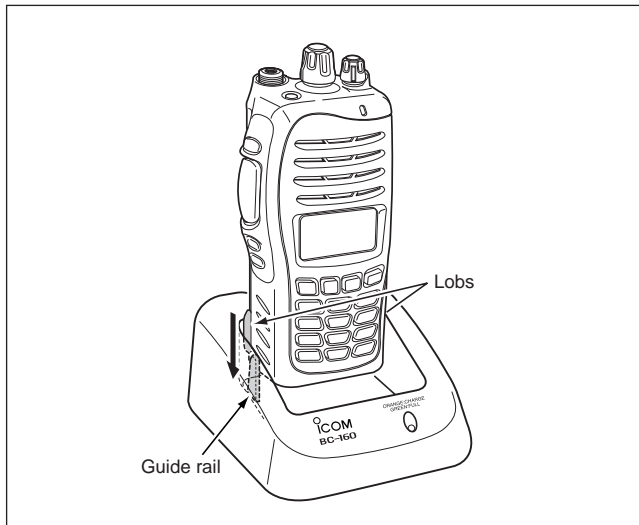

■ Optional battery case (BP-240)

When using the optional battery case attached to the transceiver, install 6 × AAA (LR03) size alkaline batteries as illustrated at right.

- ① Unhook the battery cover release hook (1), and open the cover in the direction of the arrow (2). (Fig.1)
- ② Then, install 6 × AAA (LR03) size alkaline batteries. (Fig.2)
 - Install the alkaline batteries only.
 - Be sure to observe the correct polarity.
 - Do not pin the ribbon under the batteries.
- ③ Fit the cover in the direction of the arrow (3), then close (4). And hook the battery cover release hook until it makes a 'click' sound (5). (Fig.3)

CAUTION:

- When installing batteries, make sure they are all the same brand, type and capacity. Also, do not mix new and old batteries together.
- Keep battery contacts clean. It's a good idea to clean battery terminals once a week.
- Never incinerate used battery cells since internal battery gas may cause them to rupture.
- Never expose a detached battery case to water. If the battery case gets wet, be sure to wipe it dry before using it.

NOTE: When the optional battery case is attached, the battery type must be selected to "DRY BATT" when turning the transceiver ON. (( p. 10))

Fig.1

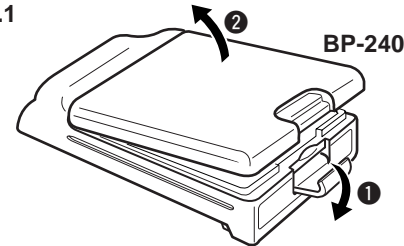

Fig.2

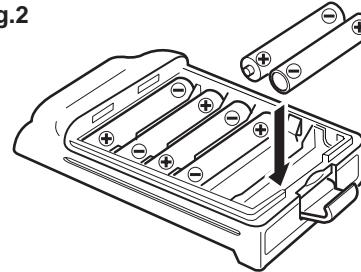
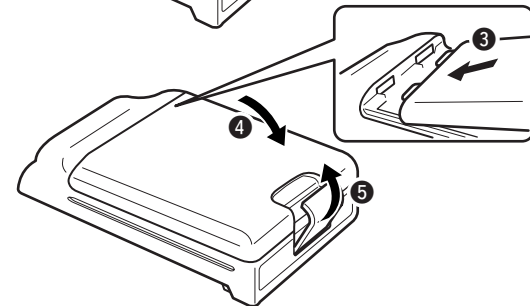
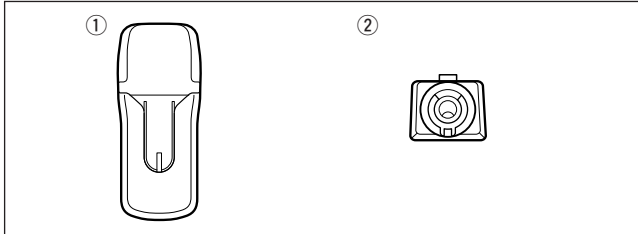

Fig.3



■ MB-93 contents

	Qty.
① Belt clip	1
② Base clip	1



■ Attaching

- ① Release the battery pack if it is attached. (([p. 2](#)))
- ② Slide the base clip in the direction of the arrow until the base clip is locked and makes a 'click' sound.

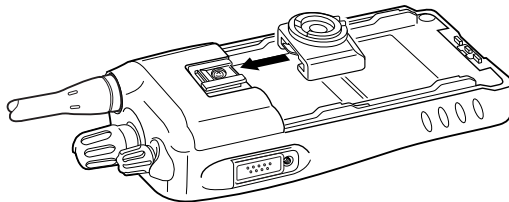

- ③ Clip the belt clip to a part of your belt. And insert the transceiver into the belt clip until the base clip inserted fully into the groove.

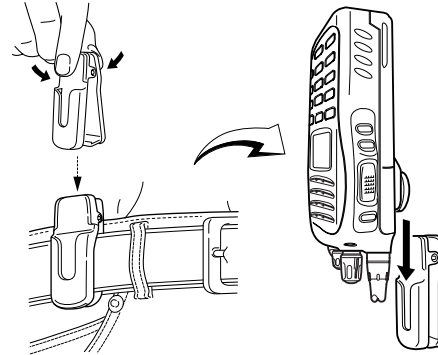

- ④ Once the transceiver is locked in place, it swivels as illustrated below.

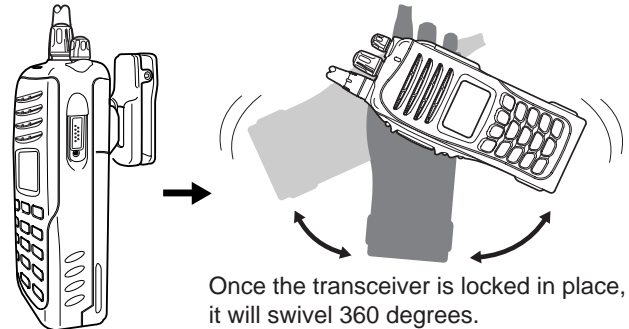

■ Detaching

- ① Turn the transceiver upside down in the direction of the arrow and pull out from the belt clip.

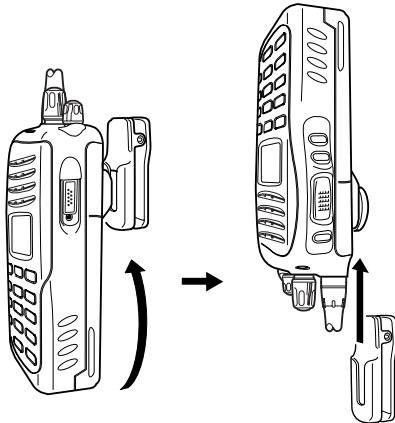

- ② Release the battery pack if it is attached. (([p. 2](#)))
 ③ Pinch the clip (①), and slide the base clip in the direction of the arrow (②).

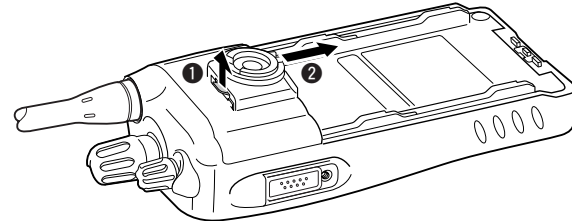

CAUTION!
HOLD THE TRANSCEIVER TIGHTLY, WHEN HANGING OR DETACHING THE TRANSCEIVER FROM THE BELT CLIP.
 Otherwise the transceiver may not be attached to the holder or swivel properly if the transceiver is accidentally dropped and the base clip is scratched or damaged.

◇ BATTERY PACK

Battery pack	Voltage	Capacity	Battery life* ¹
BP-231	7.4 V	1150 mAh	8 hrs.
BP-232	7.4 V	2000 mAh	15 hrs.
BP-240	Battery case for AAA (LR03) × 6 alkaline		— * ²

*¹ Operating periods are calculated under the following conditions;
TX : RX : standby = 5 : 5 : 90

*² Operating periods depends on the alkaline cells used.

◇ CHARGERS

•BC-119N DESKTOP CHARGER + AD-106 CHARGER ADAPTER + BC-145 AC ADAPTER

For rapid charging of battery packs. An AC adapter is supplied with the charger depending on versions. Charging time: approx. 2 hours when BP-231 is attached.

•BC-121N MULTI-CHARGER + AD-106 CHARGER ADAPTER (6 pcs.) + BC-157 AC ADAPTER

For rapid charging of up to 6 battery packs (six AD-106's are required) simultaneously. An AC adapter should be purchased separately. Charging time: approx. 2 hours when BP-231 is attached.

•BC-160 DESKTOP CHARGER + BC-145 AC ADAPTER

For rapid charging of battery packs. An AC adapter is supplied with the charger depending on versions. Charging time: approx. 2 hours when BP-231 is attached.

◇ BELT CLIPS

•MB-93 SWIVEL BELT CLIP

•MB-94 BELT CLIP

Exclusive alligator-type belt clip. The same as supplied with the transceiver.

•MB-96N/96F LEATHER BELT HANGER

◇ OPTIONAL UNITS

•UT-96R 2/5 TONE UNIT

•UT-109R /UT-110R SCRAMBLER UNITS

Non-rolling type (UT-109R)/Rolling type (UT-110R) voice scrambler unit provides higher communication security.

•UT-119 DIGITAL MODULATOR/DEMODULATOR UNIT

Provides 6.25/12.5 kHz narrow bandwidth digital mode operation.

◇ DC CABLES

•CP-17L CIGARETTE LIGHTER CABLE

Allows charging of the battery pack through a 12 V cigarette lighter socket. (For BC-119N)

•OPC-515L/OPC-656 DC POWER CABLES

Allows charging of the battery pack using a 13.8 V power source instead of the AC adapter.

OPC-515L: For BC-119N

OPC-656 : For BC-121N

◇ OTHER OPTIONS

- **SP-13** EARPHONE
Provides clear receive audio in noisy environment.
- **HM-131SC/HM-159SC** SPEAKER-MICROPHONE
Combination speaker-microphone that provides convenient operation while hanging the transceiver from your belt.
- **HS-94/HS-95/HS-97** HEADSET + **VS-1SC** VOX/PTT CASE
HS-94: Ear-hook type
HS-95: Neck-arm type
HS-97: Throat microphone
VS-1SC: VOX/PTT switch box for hands-free operation, etc.
- **FA-SC56VS/FA-SC57VS/FA-SC73US** STUBBY ANTENNAS
Shorter VHF or UHF antennas.
FA-SC56VS: Frequency range 150–162 MHz
FA-SC57VS: Frequency range 160–174 MHz
FA-SC73US: Frequency range 450–490 MHz
- **FA-SC55V/FA-SC25U/FA-SC57U/FA-SC72U** FLEXIBLE ANTENNAS
VHF or UHF antennas.
FA-SC55V: Frequency range 146–174 MHz
FA-SC25U: Frequency range 400–430 MHz
FA-SC57U: Frequency range 440–470 MHz
FA-SC72U: Frequency range 470–520 MHz

Some options may not available in some countries. Please ask your dealer for details.

◇ About VS-1SC VOX/PTT CASE

The VS-1SC is a VOX/PTT unit for Icom handheld transceivers, and allows you hands-free operation.

An optional headset (HS-94, etc.) is required for operation.

- The VOX (Voice Operated Transmission) function starts transmission without pushing PTT switch when you speak into the microphone; then, automatically returns to receive when you stop speaking.

Features

- 9-pin Spring-plug type head SP/MIC plug is equipped
- Water resistant construction
- Durable construction
- Equipped with a PTT switch and revolving clip

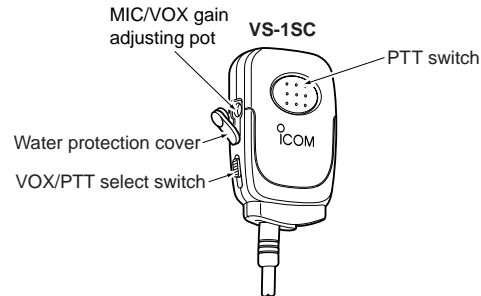

9 OPTIONS

VOX gain and delay adjustment

- ① Attach the connector of the VS-1SC into the multi-connector on the transceiver and tighten the screw.
 - Toggle the VOX/PTT select switch to [VOX].
- ② Enter user set mode. (☞ p. 16))
- ③ Push [P0] several times to select the “VOX Gain” or “VOX Delay” items. Then, push [Side2] or [Side3] to set the desired level/condition.
- ④ Rotate [VOL] to turn the power OFF to exit user set mode.

• VOX Gain

The VOX sensitivity level can be adjusted from OFF or 1 to 6 (more sensitive).

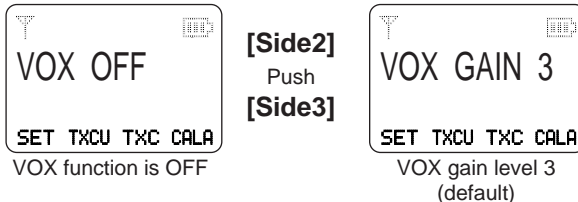

• VOX Delay

The VOX delay time can be set from 0.5 to 3.0 sec. (0.5 sec. step) for a convenient interval before returning to receive.

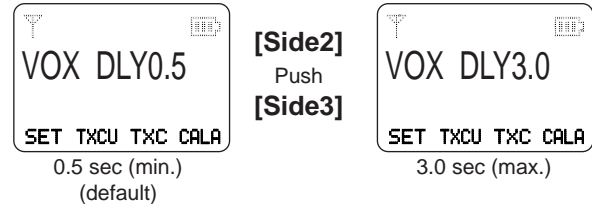

NOTE: MIC/VOX gain can be adjusted via the Adjusting pot using a thin screw driver.



Your Icom radio generates RF electromagnetic energy during transmit mode. This radio is designed for and classified as “Occupational Use Only”, meaning it must be used only during the course of employment by individuals aware of the hazards, and the ways to minimize such hazards.

This radio is NOT intended for use by the “General Population” in an uncontrolled environment.

This radio has been tested and complies with the FCC RF exposure limits for “Occupational Use Only”. In addition, your Icom radio complies with the following Standards and Guidelines with regard to RF energy and electromagnetic energy levels and evaluation of such levels for exposure to humans:

- FCC OET Bulletin 65 Edition 97-01 Supplement C, Evaluating Compliance with FCC Guidelines for Human Exposure to Radio Frequency Electromagnetic Fields.
- American National Standards Institute (C95.1-1992), IEEE Standard for Safety Levels with Respect to Human Exposure to Radio Frequency Electromagnetic Fields, 3 kHz to 300 GHz.
- American National Standards Institute (C95.3-1992), IEEE Recommended Practice for the Measurement of Potentially Hazardous Electromagnetic Fields— RF and Microwave.
- The following accessories are authorized for use with this product. Use of accessories other than those specified may result in RF exposure levels exceeding the FCC requirements for wireless RF exposure.: Belt Clip (MB-94), Rechargeable Li-Ion Battery Pack (BP-232) and Speaker-microphone (HM-131SC).

**CAUTION**

To ensure that your exposure to RF electromagnetic energy is within the FCC allowable limits for occupational use, always adhere to the following guidelines:

- **DO NOT** operate the radio without a proper antenna attached, as this may damage the radio and may also cause you to exceed FCC RF exposure limits. A proper antenna is the antenna supplied with this radio by the manufacturer or antenna specifically authorized by the manufacturer for use with this radio.
- **DO NOT** transmit for more than 50% of total radio use time (“50% duty cycle”). Transmitting more than 50% of the time can cause FCC RF exposure compliance requirements to be exceeded. The radio is transmitting when the TX indicator lights red. You can cause the radio to transmit by pressing the “PTT” switch.
- **ALWAYS keep** the antenna at least 2.5 cm (1 inch) away from the body when transmitting and only use the Icom belt-clips listed on page 26 when attaching the radio to your belt, etc., to ensure FCC RF exposure compliance requirements are not exceeded. To provide the recipients of your transmission the best sound quality, hold the antenna at least 5 cm (2 inches) from your mouth, and slightly off to one side.

The information listed above provides the user with the information needed to make him or her aware of RF exposure, and what to do to assure that this radio operates with the FCC RF exposure limits of this radio.

10 SAFETY TRAINING INFORMATION

Electromagnetic Interference/Compatibility

During transmissions, your Icom radio generates RF energy that can possibly cause interference with other devices or systems. To avoid such interference, turn off the radio in areas where signs are posted to do so. **DO NOT** operate the transmitter in areas that are sensitive to electromagnetic radiation such as hospitals, aircraft, and blasting sites.

Occupational/Controlled Use

The radio transmitter is used in situations in which persons are exposed as consequence of their employment provided those persons are fully aware of the potential for exposure and can exercise control over their exposure.

Count on us!

A-6488D-1EX-①
Printed in Japan
© 2006 Icom Inc.

Icom Inc.

1-1-32 Kamiminami, Hirano-ku, Osaka 547-0003, Japan

Free Manuals Download Website

<http://myh66.com>

<http://usermanuals.us>

<http://www.somanuals.com>

<http://www.4manuals.cc>

<http://www.manual-lib.com>

<http://www.404manual.com>

<http://www.luxmanual.com>

<http://aubethermostatmanual.com>

Golf course search by state

<http://golfingnear.com>

Email search by domain

<http://emailbydomain.com>

Auto manuals search

<http://auto.somanuals.com>

TV manuals search

<http://tv.somanuals.com>