



# SERVICE MANUAL

VHF/UHF DUALBAND FM TRANSCEIVER

## IC-E7

Downloaded by  
RadioAmateur.EU

S-14217HZ-C1  
Nov. 2005

Icom Inc.

---

## INTRODUCTION

---

This service manual describes the latest service information for the **IC-E7** VHF/UHF DUALBAND FM TRANSCEIVER at the time of publication.

MODEL	VERSION	SYMBOL
IC-E7	Europe	EUR
	Italy	ITR
	France	FRA
	United Kingdom	UK

To upgrade quality, all electrical or mechanical parts and internal circuits are subject to change without notice or obligation.

---

## DANGER

---

**NEVER** connect the transceiver to an AC outlet or to a DC power supply 3.7 V. Such a connection could cause a fire or electric hazard.

**DO NOT** expose the transceiver to rain, snow or any liquids.

**DO NOT** reverse the polarities of the power supply when connecting the transceiver.

**DO NOT** apply an RF signal of more than 20 dBm (100 mW) to the antenna connector. This could damage the transceiver's front end.

---

## ORDERING PARTS

---

Be sure to include the following four points when ordering replacement parts:

1. 10-digit Icom parts number
2. Component name and informations
3. Equipment model name and unit name
4. Quantity required

### <SAMPLE ORDER>

5030002860 LCD	A01B004X	IC-E7	Main unit	5 pieces
8810008990 Screw	PH B0 2×10 ZK	IC-E7	Chassis	10 pieces

Addresses are provided on the inside back cover for your convenience.



---

## REPAIR NOTES

---

1. Make sure the problem is internal before disassembling the transceiver.
2. **DO NOT** open the transceiver until the transceiver is disconnected from its power source.
3. **DO NOT** force any of the variable components. Turn them slowly and smoothly.
4. **DO NOT** short any circuits or electronic parts. An insulated turning tool **MUST** be used for all adjustments.
5. **DO NOT** keep power ON for a long time when the transceiver is defective.
6. **DO NOT** transmit power into a signal generator or a sweep generator.
7. **ALWAYS** connect a 30 dB to 40 dB attenuator between the transceiver and a deviation meter or spectrum analyzer when using such test equipment.
8. **READ** the instructions of test equipment thoroughly before connecting equipment to the transceiver.

Icom, Icom Inc. and ICOM logo are registered trademarks of Icom Incorporated (Japan) in the United States, the United Kingdom, Germany, France, Spain, Russia and/or other countries.

---

## TABLE OF CONTENTS

---

<b>SECTION 1</b>	<b>SPECIFICATIONS</b>	
<b>SECTION 2</b>	<b>INSIDE VIEWS</b>	
<b>SECTION 3</b>	<b>DISASSEMBLY INSTRUCTIONS</b>	
<b>SECTION 4</b>	<b>CIRCUIT DESCRIPITON</b>	
4 - 1	RECEIVER CIRCUITS .....	4 - 1
4 - 2	TRANSMITTER CIRCUITS .....	4 - 2
4 - 3	PLL CIRCUITS .....	4 - 3
4 - 4	PORT ALLOCATIONS .....	4 - 4
4 - 5	POWER SUPPLY CIRCUITS .....	4 - 5
<b>SECTION 5</b>	<b>ADJUSTMENT PROCEDURES</b>	
5 - 1	PREPARATION .....	5 - 1
5 - 2	FREQUENCY AND TRANSMIT ADJUSTMENT .....	5 - 4
5 - 3	RECEIVE ADJUSTMENT .....	5 - 5
<b>SECTION 6</b>	<b>PARTS LIST</b>	
<b>SECTION 7</b>	<b>MECHANICAL PARTS AND DISASSEMBLY</b>	
<b>SECTION 8</b>	<b>SEMICONDUCTOR INFORMATION</b>	
<b>SECTION 9</b>	<b>BOARD LAYOUTS</b>	
9 - 1	MAIN UNIT .....	9 - 1
9 - 2	PA BOARD .....	9 - 1
9 - 3	VCO BOARD .....	9 - 1
<b>SECTION 10</b>	<b>BLOCK DIAGRAM</b>	
<b>SECTION 11</b>	<b>CIRCUIT DIAGRAM</b>	
<b>SECTION 12</b>	<b>BC-164</b>	

# SECTION 1 SPECIFICATIONS

## GENERAL

- Frequency range :

Version	Transmit (MHz)	Receive (MHz)
[EUR], [UK]	144.000–146.000 430.000–440.000	0.495–999.990
[ITR]	144.000–146.000 430.000–434.000 435.000–438.000	144.000–146.000 430.000–434.000 435.000–438.000
[FRA]	146.000–146.000 430.000–440.000	0.495–29.995 50.200–51.200 76.000–135.995 144.000–146.000 430.000–440.000

- Operating mode : FM, AM\*, WFM\* (\*RX only)
- Memory channels : 1000 channels
- Call channels : 2 channels
- Scan types : Full/Program/Priority/  
Memory Channel/Bank/  
Bank-Link/Skip/Tone
- Frequency stability :  $\pm 6$  ppm ( $-10^{\circ}\text{C}$  to  $+60^{\circ}\text{C}$ )
- Tuning steps : 5/6.25/8.33/9/10/12.5/15/20/  
25/30/50/100 and 200 kHz
- Antenna impedance : 50  $\Omega$  (SMA type)
- Power supply requirement : Specified Icom's battery  
pack only  
(operating voltage 3.7 V)
- Current drain :  

TRANSMIT	VHF	High	1.5 A
		Low	0.4 A (approx.)
	UHF	High	1.5 A
		Low	0.5 A (approx.)
RECEIVE	Stand-by		80 mA (approx.)
	Max. audio		Less than 150 mA
- Operating temp. range :  $-10^{\circ}\text{C}$  to  $+60^{\circ}\text{C}$
- Dimensions (projections not included) : 47 (W)  $\times$  81 (H)  $\times$  28 (D) mm
- Weight (antenna, BP-243 included) : 160 g (approx.)
- MIC/SP connector : 4-conductor 3.5 (d) mm; (1/8")  
2 k $\Omega$ /8  $\Omega$

## TRANSMITTER

- Output power :  

VHF	1.5 W (High)
	0.1 W (Low; approx.)
UHF	1.0 W (High)
	0.1 W (Low; approx.)
- Modulation system : Variable reactance frequency  
modulation
- Maximum deviation :  $\pm 5.0$  kHz
- Spurious emissions : Less than  $-60$  dB (TX High)  
Less than  $-50$  dB (TX Low)

## RECEIVER

- Receiving system : Double conversion  
superheterodyne system
- Intermediate frequencies :  

FM, AM	1st; 46.35 MHz
	2nd; 450 kHz
WFM	1st; 14.85 MHz
	2nd; 450 kHz
- Sensitivity\* :  
(except spurious points; maximum sensitivity)

Frequency (MHz)	FM	AM	WFM
0.495–4.995	–	+7 dB $\mu$	–
5.000–29.995	–	+3 dB $\mu$	–
30.000–75.995	–7 dB $\mu$	–	+5 dB $\mu$
76.000–89.995	–	–	–
90.000–107.995	–14 dB $\mu$	–	–
108.000–117.995	–	+3 dB $\mu$	–
118.000–136.995	–	–	–
137.000–143.995	–	–	–
144.000–147.995	–15 dB $\mu$	–	–
148.000–179.995	–14 dB $\mu$	–	–
330.000–369.995	+5 dB $\mu$	–	–
370.000–399.995	–10 dB $\mu$	–	–
400.000–429.995	–13 dB $\mu$	–	–
430.000–449.995	–15 dB $\mu$	–	–
450.000–499.995	–5 dB $\mu$	–	–
600.000–799.990	0 dB $\mu$	–	+8 dB $\mu$
799.995–939.990	–	–	–
940.000–999.990	+5 dB $\mu$	–	–

\*FM and WFM are measured at 12 dB SINAD, AM is measured at 10 dB S/N.

- Squelch sensitivity (at threshold) : Less than  $-15$  dB $\mu$
- Selectivity :  

FM, AM	More than 12 kHz/6 dB
	Less than 30 kHz/60 dB
WFM	More than 150 kHz/10 dB
	Less than 700 kHz/20 dB
- Spurious image rejection : More than 40 dB
- Audio output power : More than 50 mW at 10%  
distortion with an 8  $\Omega$  load

All stated specifications are subject to change without notice or obligation.

# SECTION 2 INSIDE VIEWS

## • MAIN UNIT (TOP VIEW)

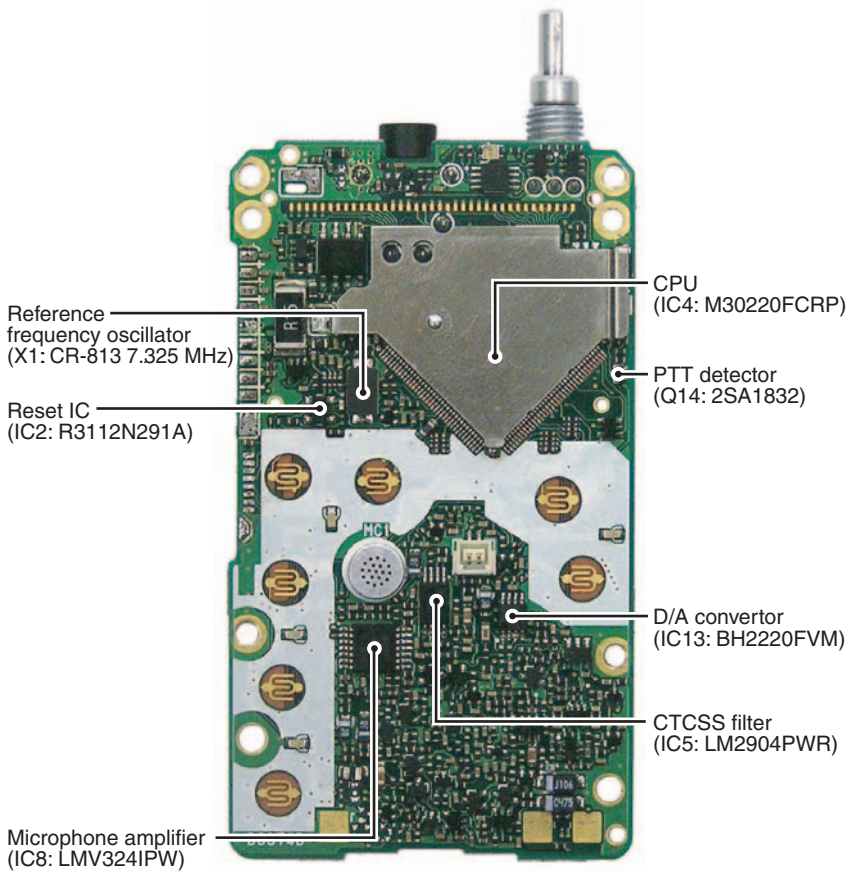

## • MAIN UNIT (BOTTOM VIEW)

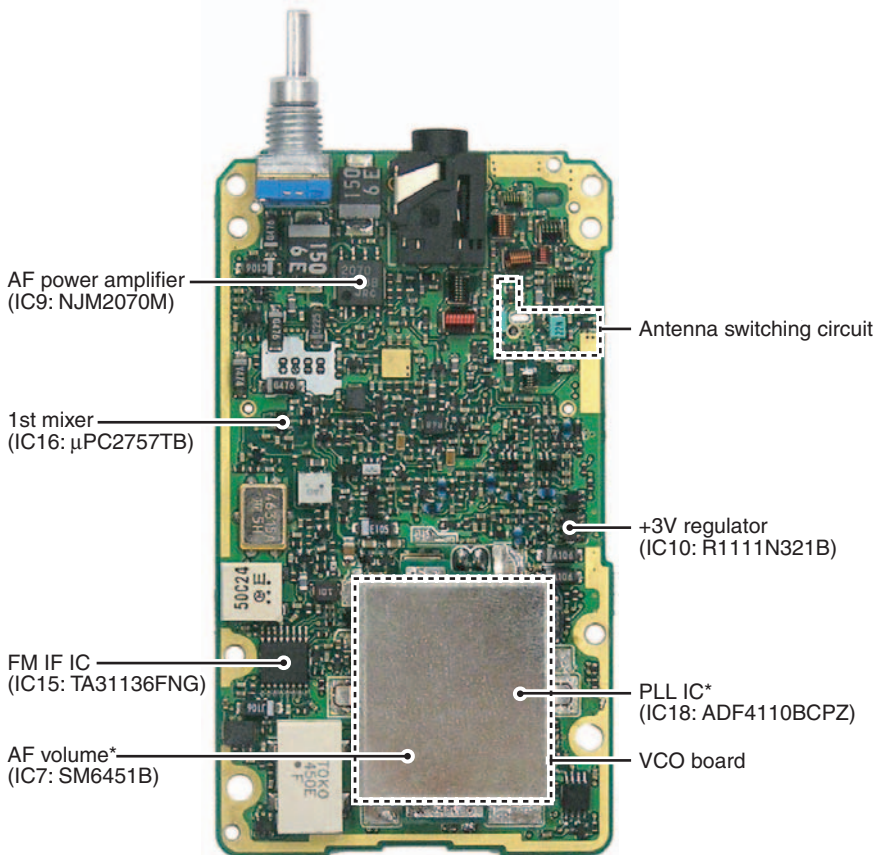

\* Located under the VCO board

## • PA BOARD

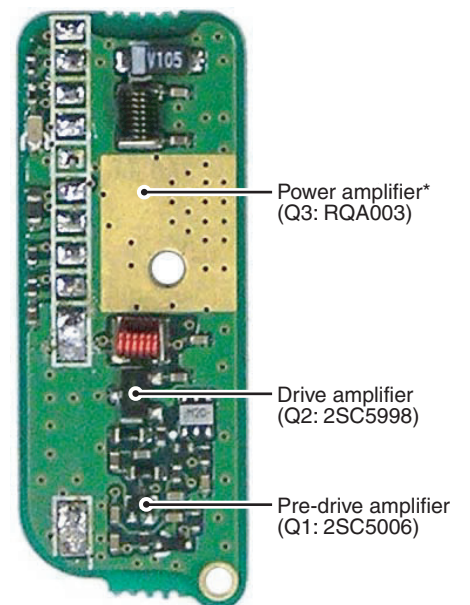

\* Located bottom side of the point.

## SECTION 3 DISASSEMBLY INSTRUCTIONS

### • Removing the chassis

- ① Remove the battery pack.
- ② Remove the jack cap (A) and unscrew the antenna nut (B).
- ③ Remove the dial knob (C).
- ④ Unscrew 2 screws (D) and lift up the chassis in the direction of the arrow.

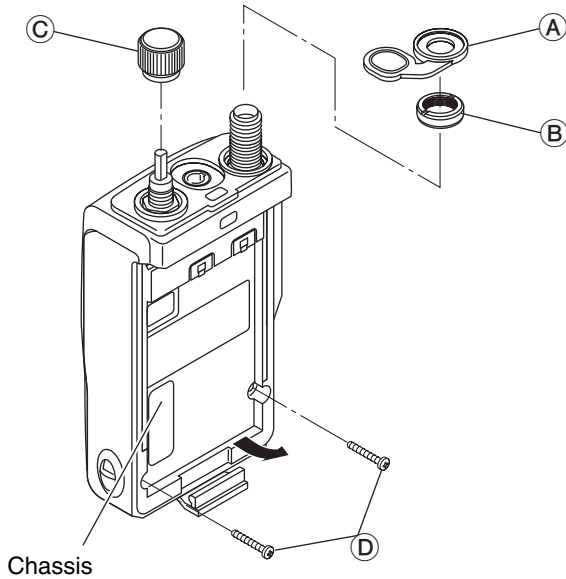

- ⑤ Incline the chassis as figure below and disconnect the speaker cable (E).
- ⑥ Remove the chassis from the front panel.

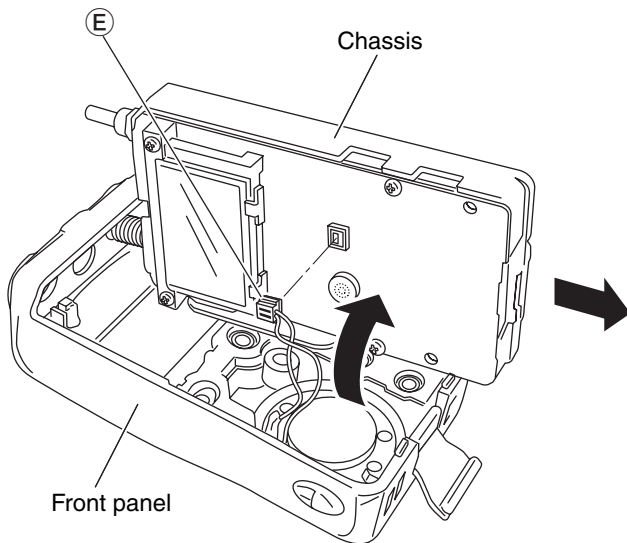

### • Removing the MAIN unit and PA board

- ① Unscrew 2 screws (A), then remove the LCD panel (B).
- ② Unscrew 5 screws (C) and dial nut (D).
- ③ Unsolder 2 points (E).

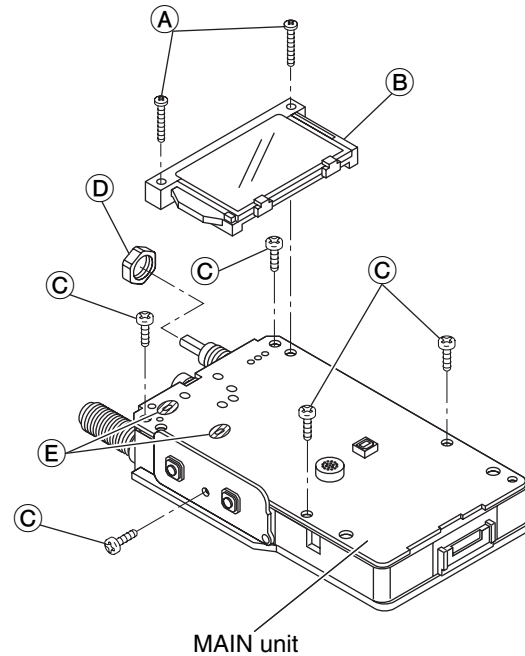

- ④ Release the projection (F), and remove the MAIN unit.
- ⑤ Unsolder 11 points (G) and remove the PA board from the MAIN unit.

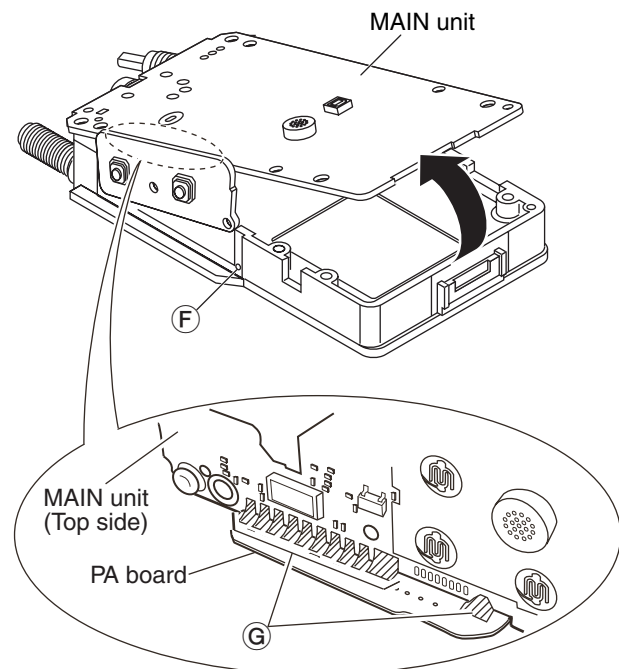



# SECTION 4 CIRCUIT DESCRIPTION

## 4-1 RECEIVE CIRCUITS 4-1-1RF CIRCUITS (MAIN UNIT)

This transceiver has 4 RF circuits to provide wide receiving range. The received signals from the antenna connector (CHASSIS; J1) are applied to each RF circuits for the frequency coverage, and amplified within the frequency coverage.

### • While receiving 0.495–76 MHz

The 0.495–76 MHz band signals are passed through the three low-pass filters (LPF; L32, L34, L39, L42, C284, C290, C294, C307, C314), then applied to the RF amplifier (Q38) via the band switches (D30, D43) and LPF or BPF.

The 0.495–30 MHz band signals are passed through the LPF (L20, C241, C242, C247), the 30–76 MHz signals are passed through the Bandpass Filter (BPF; D39, L21, L24, C238, C256) before being applied to the RF amplifier (Q38).

The amplified signals are applied to the 1st mixer (IC16, pin 1) via the band switch (D16).

### - 0.495–76 MHz -

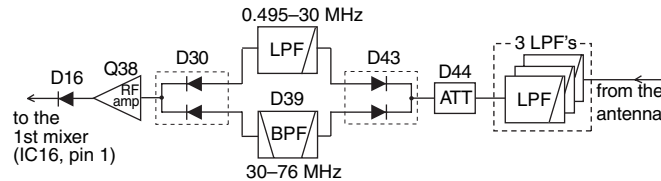

### • While receiving 76–300 MHz

The 76–300 MHz band signals are passed through two LPFs (L39, L42, C307, C314) and a couple of High-pass Filter (HPF; L33, C287, C293) and LPF (L29, L31, C266, C269, C276, C283, C514, C516), then applied to the RF amplifier (Q42) via the antenna switching circuit (D35, D38) and the LPF (D53, L44, C295, C303).

The amplified signals are then applied to the 1st mixer (IC16, pin 1) via the BPF (D27, D28, D31, D36, L10, L11, L22, L23, C208, C210, C216, C228, C233, C243) and band switch (D21).

### - 76–300 MHz -

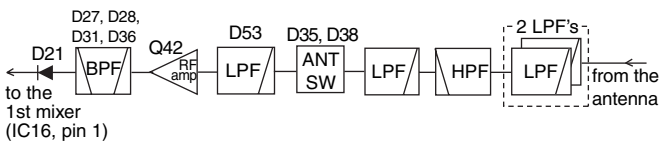

### • While receiving 300–500 MHz

The 300–500 MHz band signals are passed through the LPF (L42, C314) and a couple of HPF (L38, C302, C306) and LPF (D41, D45, L26, L30, C255, C257, C262, C275, C282, C289, C515), then applied to the RF amplifier (Q43) via the antenna switching circuit (D34, D37) and the BPF (D55, L36, L106, C304, C522, C523).

The amplified signals are then applied to the 1st mixer (IC16, pin 1) via the BPF (D26, D32, L13, L25, C204, C215, C222, C236, C244, C520, C521) and band switch (D22).

### - 300–500 MHz -

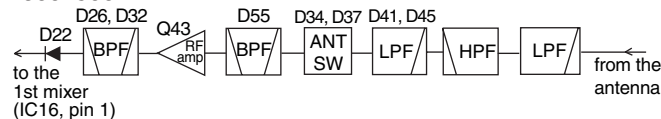

### • While receiving 500–999 MHz

The 500–999 MHz band signals are passed through the HPF (L41, C311, C313) and band switch (D54), then applied to the RF amplifier (Q45) via the attenuator (D46). The amplified RF signals are applied to another RF amplifier (Q39) via the BPF (D33, D40, L15, L27, L28, C229, C237, C245, C252, C261). The amplified RF signals are then applied to the 1st mixer (IC16, pin 1) via the band switch (D23).

### - 500–999 MHz -

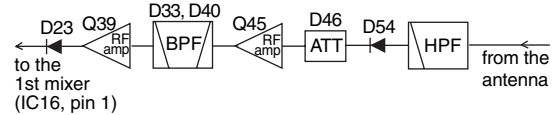

## 4-1-2 1ST IF CIRCUITS (MAIN UNIT)

The 1st IF circuits contain the 1st mixer, 1st IF amplifier and the 1st IF filter. The 1st IF mixer converts the received signals into a fixed frequency of the 1st Intermediate Frequency (IF) signal. The converted 1st IF signal is filtered at the 1st IF filters, then amplified at the 1st IF amplifier.

The received signals from the RF circuits are applied to the 1st IF mixer (IC16, pin 1), and converted into the 46.35 MHz (AM/FM)/14.85 MHz (WFM) 1st IF signal by being mixed with 1st Local Oscillator (LO) signals from the VCOs (VCO BOARD).

While receiving 0.5–76 MHz band signals, the 1st LO signals are generated at 50 MHz VCO (VCO BOARD; Q10, Q13, D7, D8), and for receiving 76–280 MHz band signals, the 1st LO signals are generated at 144 MHz VCO (VCO BOARD; Q9, Q12, D6).

While receiving 280–999 MHz band signals, the 1st LO signals are generated at 430 MHz VCO (VCO BOARD; Q8, Q11, D5). If the receiving frequency is 500 MHz and above, the VCO output signal is doubled at the doubler circuit (Q18) before being applied to the 1st mixer (IC16, pin 3).

The converted IF signal is passed through the 1st IF filter F13 (AM/FM mode) or F12 (WFM mode) to filter out the unwanted signal, then applied to the 1st IF amplifier (Q9). The amplified 1st IF signal is then applied to the FM IF IC (IC15, pin 16).

### • 1st IF CIRCUIT

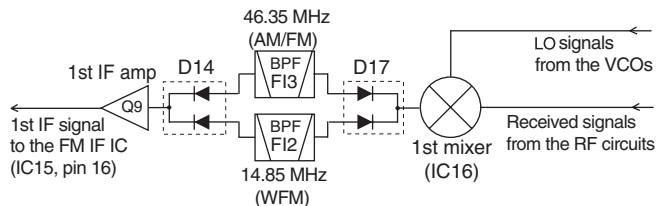

### 4-1-3 2ND IF AND DEMODULATOR CIRCUITS (MAIN UNIT)

The 1st IF signal is converted into the 2nd IF signal and demodulated in the FM IF IC. The FM IF IC contains 2nd mixer, limiter amplifier, quadrature detector, etc. in its package.

The 1st IF signal from the 1st IF amplifier (Q9) is applied to the 2nd mixer in the FM IF IC (IC15, pin 16), and converted into the 2nd IF signal by being mixed with the 2nd LO signal from the reference frequency oscillator (X2) tripled by the tripler (Q29).

The converted 2nd IF signal is output from pin 3, and passed through the 2nd IF filter via the FM/WFM switch (D12) to suppress sideband noise.

#### • FM/WFM mode

In FM mode, the 2nd IF signal is passed through the BPF (F11). In WFM mode, the signal passed through the LPF (L2, C136).

The filtered 2nd IF signal is applied to the limiter amplifier in the FM IF IC (pin 5) via the FM/WFM switch (D10). The amplified 2nd IF signal is FM-demodulated at the quadrature detector section and output from pin 9. The demodulated AF signals are applied to the AF amplifier circuits.

#### • AM mode

The 2nd IF signal is passed through the F11 and applied to the AM demodulator circuit (Q19, Q20). The demodulated AF signals are applied to the AF amplifier circuits.

### 4-1-4 AF AMPLIFIER CIRCUITS (MAIN UNIT)

The demodulated AF signals from the demodulator circuits are amplified and filtered in AF amplifier circuits.

#### • FM/WFM mode

The demodulated AF signals from the FM IF IC (IC15, pin 9) are passed through the AF switch (IC14, pins 1,2) and AF filter circuit (Q10, D5). The filtered AF signals are applied to the AF amplifier (Q12).

#### • AM mode

The demodulated AF signals from the AM-demodulator circuit (Q19, Q20) are passed through the AF filter bypass switch (Q28) and applied to the AF amplifier (Q12).

The amplified AF signals are applied to the electric volume (IC7, pin 11) and level adjusted. The level adjusted AF signals are output from pin 12, and applied to the AF amplifier (IC9, pin 2) to obtain more than 50 mW of AF output power. The power amplified AF signals are then output from pin 6, and applied to the internal speaker (CHASSIS; SP1) or connected external speaker via [MIC/SP] connector (J4).

#### • AF CIRCUITS

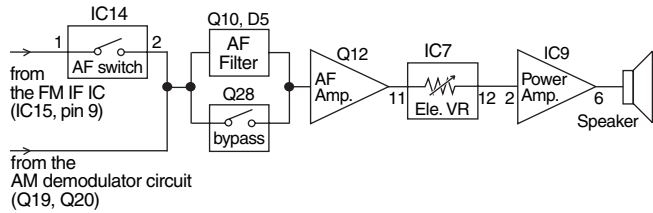

### 4-1-5 AGC CIRCUIT

A portion of the AM-demodulated signals are converted into DC voltage, and fed back to the RF circuits as the AGC (Automatic Gain Controller) signal.

The AGC signal controls the bias of the 1st IF amplifier (Q9) and RF amplifiers (Q38, Q39, Q42, Q43, Q45) according to the received signal strength to stabilize the demodulated AF signal level.

### 4-1-6 SQUELCH CIRCUITS

#### • NOISE SQUELCH

The noise squelch mutes the AF output signals when no RF signals are received. By detecting noise components in the demodulated AF signals, the squelch circuit toggles the AF power amplifier ON and OFF.

A portion of the FM-demodulated AF signals from the FM IF IC (IC15, pin 9) are passed through the noise filter (R186, R187, R192, R196, R197, R204, C150, C152, C158, C162, C164). The filtered noise signals are then applied to the noise amplifier in the FM IF IC (IC15, pins 7, 8) to be amplified the noise components only.

### • 2ND IF DEMODULATOR CIRCUIT

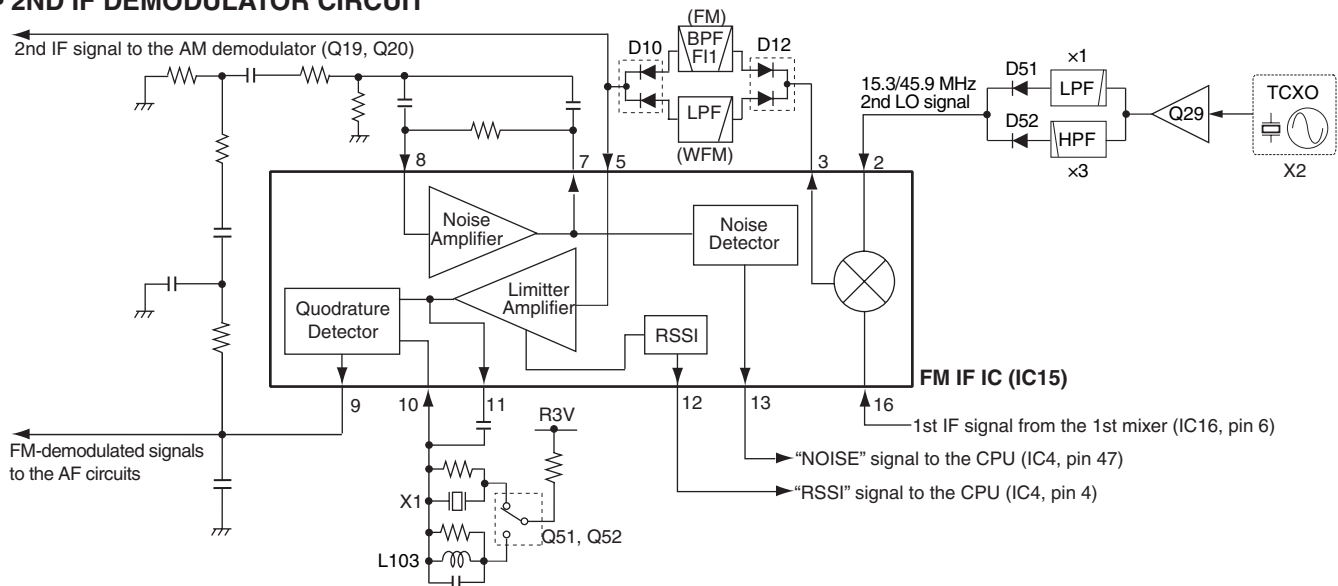



The amplified noise components are converted into the pulse-type signal at the noise detector section, and output from pin 13 as the "NOISE" signal. The "NOISE" signal is applied to the CPU (IC4, pin 47). Then the CPU outputs "AFON" signal from pin 68 according to the "NOISE" signal level to toggle the AF power regulator (Q46, Q47) ON and OFF.

#### • TONE SQUELCH

The tone squelch detects the tone signal in the demodulated AF signals, and opens the squelch only when matched sub-audible tone frequency is detected in the received signal.

While the tone squelch is in use, and the received signal contains no sub-audible tone signal or mismatched tone frequency, the tone squelch mutes the AF signals even if the noise squelch is open.

A portion of the demodulated AF signals from the FM IF IC (IC15, pin 9) are passed through the two-staged CTCSS/DTCS filter (IC5, pins 5, 7 and pins 1, 2) to suppress unwanted voice signals. The filtered CTCSS/DTCS signals are applied to the CPU (IC4, pin 7).

The CPU decodes the CTCSS/DTCS signal, and outputs "AFON" signal from pin 68 according to the set CTCSS/DTCS signal to toggle the AF power regulator (Q46, Q47) ON and OFF.

## 4-2 TRANSMIT CIRCUITS

### 4-2-1 MICROPHONE AMPLIFIER CIRCUIT (MAIN UNIT)

The microphone amplifier circuit contains AF amplifier, IDC, splatter filter, etc. The AF signals from the microphone (MIC signals) are filtered and level-adjusted at this circuit.

The AF signals from the microphone are applied to the MIC amplifier (IC8, pin 13). The amplified MIC signals are output from pin 14, and passed through the IDC (Instantaneous Deviation Control; IC8, pins 8, 9) and splatter filter (IC8, pins 5, 7).

The IDC limits the level of the amplitude of MIC signals to prevent over deviation, and the splatter filter suppress 3 kHz and higher audio components. The filtered MIC signals are passed through the MIC mute switch (Q37) and modulation volume (Q34).

While receiving, the voltage of R3V line is applied to the base terminal of the MIC mute switch (Q37) to turn it ON, thus the MIC line is connected to the ground and the MIC signals are muted.

The modulation volume (Q34) adjusts the deviation according to "MODSET" signal from the D/A converter (IC13, pin 2).

The level adjusted MIC signals are then applied to the modulation circuit (VCO BOARD; D5 or D6) to modulate the VCO oscillating signal.

#### • MICROPHONE AMPLIFIER CIRCUITS

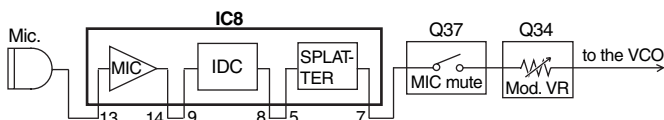

### 4-2-2 MODULATION CIRCUIT (VCO BOARD)

The modulation circuit modulates the VCO oscillating signal with the AF signals from the microphone and the tone signals from the CPU.

#### • MICROPHONE SIGNALS

The level adjusted MIC signals from the modulation volume (Q34) are applied to the D5 (in transmitting on 430 MHz band) or D6 (in transmitting on 144 MHz band) to modulate the VCO oscillating signal by changing the reactance of D5/D6. The modulated VCO output signal is buffer-amplified by Q14 and Q19, and applied to the PA BOARD via doubler switches (D13, D17) and TX/RX switch (MAIN UNIT; D18) as a transmit signal.

#### • TONE SIGNALS

The CTCSS and DTCS signals are generated by the CPU (IC4) and output from pin 141. The CTCSS and DTCS signals are applied to the modulation circuit (VCO BOARD; D5 or D6) via the tone filter (Q41). To ensure the modulation, the DTCS signal is also applied to the reference frequency oscillator (X2, pin 1), after passing through the DTCS filter (IC8, pins 1, 2) and modulation volume (Q48).

### 4-2-3 TRANSMIT AMPLIFIERS (PA BOARD)

The VCO output signal is amplified to transmit output power level by the transmit amplifiers.

The VCO output signal from VCO BOARD is passed through the TX/RX switch (MAIN UNIT; D18) and level adjust circuit (D1), and applied to the pre-driver (Q1), driver (Q2) and power (Q3) amplifiers in sequence to be amplified to the transmit output power level. The power amplified transmit signal is passed through the antenna switching circuit (MAIN UNIT; D34, D35) and filters.

### 4-2-4 TRANSMIT FILTERS (MAIN UNIT)

The power amplified transmit signal from the PA BOARD is filtered at the transmit filters. The transmit filters prevent unwanted RF signals being emitted to the air.

While transmitting on 144 MHz band, the transmit signal is passed through the LPF (L12, C223, C227), antenna switch circuit (D35, D38), a couple of LPF (L29, L31, C266, C269, C276, C283, C514, C516) and HPF (L33, C287, C293), and two LPFs (L39, L42, C307, C314) before being applied to the antenna connector (CHASSIS; J1).

#### • 144 MHz

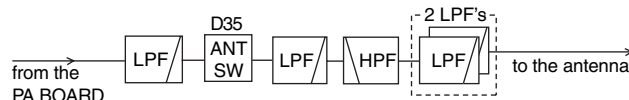

While transmitting on 430 MHz band, the transmit signal is passed through the HPF (L14, C220, C226), antenna switching circuit (D34, D37), a couple of LPF (D41, D45, L26, L30, C255, C257, C262, C275, C282, C289, C515) and HPF (L38, C302, C306, C310), and the LPF (L42, C314) before being applied to the antenna connector (CHASSIS; J1).

#### • 430 MHz

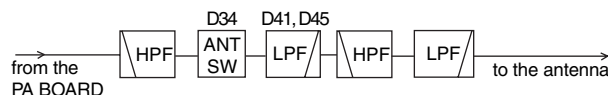

## 4-3 PLL CIRCUITS

### 4-3-1 VCO CIRCUITS (VCO BOARD)

This transceiver has 3 VCOs; 50 MHz VCO, 144 MHz VCO and 430 MHz VCO. The 50 MHz VCO oscillates the 1st LO signals, 144 MHz VCO and 430 MHz VCO oscillate both transmit output and 1st LO signals.

#### • 50 MHz VCO

The 50 MHz VCO (Q10, Q13, D7, D8) generates the 1st LO signals for receiving 0.5–76 MHz band signals. The output signals are amplified at the buffer amplifiers (Q14, Q19), and passed through the doubler switches (D13, D17), and then applied to the 1st mixer (IC16, pin 3) via TX/RX switch (MAIN UNIT; D56).

#### • 144 MHz VCO

The 144 MHz VCO (Q9, Q12, D6) generates both of transmit output signal for 144 MHz band and 1st LO signals for receiving 76–280 MHz.

While receiving, the VCO oscillates the 1st LO frequency, and the VCO output signals are amplified at the buffer amplifiers (Q14, Q19). The buffer-amplified signals are passed through the doubler switches (D13, D17), then applied to the 1st mixer (IC16, pin 3) via TX/RX switch (MAIN UNIT; D56).

While transmitting, the VCO oscillates the transmit frequency, and the VCO output signal is amplified at the buffer amplifiers (Q14, Q19). The buffer-amplified signals are passed through the doubler switches (D13, D17), then applied to the PA BOARD via TX/RX switch (MAIN UNIT; D18).

#### • 430 MHz VCO

The 430 MHz VCO (Q8, Q11, D5) generates both of the transmit output signal for 430 MHz band and 1st LO signals for receiving 280–990 MHz.

While receiving, the VCO oscillates the 1st LO frequency, and the VCO output signals are amplified by the buffer amplifiers (Q14, Q19).

If the receiving frequency is 500 MHz and below, the buffer-amplified signals are passed through the doubler switches (D13, D17), then applied to the 1st mixer (IC16, pin 3) via TX/RX switch (MAIN UNIT; D56).

If the receiving frequency is 500 MHz and above, the buffer-amplified signals are applied to the doubler circuit (Q18, D14, D15) via doubler switch (D12). The doubled signals are then applied to the 1st mixer (IC16, pin 3) via doubler switch (D16) and TX/RX switch (MAIN UNIT; D56).

While transmitting, The VCO oscillates the transmit frequency, and the VCO output signal is amplified at the buffer amplifiers (Q14, Q19), then applied to the PA BOARD via TX/RX switch (MAIN UNIT; D18).

A portion of the VCO output signals generated at each VCO are applied to the PLL IC (IC18, pin 5) via buffer amplifier (Q14) and LO amplifier (Q2) for comparison signal.

### 4-3-2 PLL CIRCUIT

The PLL circuit provides stable oscillation of the transmit frequency and receive 1st LO frequency. The PLL circuit compares the phase of the divided VCO frequency with the reference frequency. The PLL output frequency is controlled by the divided ratio (N-data) from the CPU.

The amplified signals from LO amplifier (Q2) are applied to the PLL IC (IC18, pin 5). The applied signals are divided at the prescaler and OSC counter according to the "PDA" signal from the CPU (IC4, pin 32). The divided signal is phase-compared with the reference frequency at the phase detector.

The phase difference is output from pin 20 as a pulse type signal after being passed through the charge pump and loop filter switch. The output signal is applied to the each VCO (VCO BOARD) after being converted into the DC voltage (lock voltage) at the loop filters.

The lock voltage for 50 MHz VCO ("LV1") is generated by being passed through the the loop filter A (Q11, Q13, R68, R72, R74, R76, R80, R81, C72, C79, C80, C500) via the loop filter switch A (IC22, pins 5, 6). The lock voltage for 144 MHz VCO and 430 MHz ("LV2") is generated by being passed through the loop filter B (Q54, Q56, R327–R331, R337, C485, C486, C488, C501) via the loop filter switch A (IC22, pins 1, 2) and B (IC19, pins 1, 2).

If the oscillated signal drifts, its phase changes from that of the reference frequency, causing a lock voltage change to compensate for the drift in the oscillated frequency.

## • PLL AND VCO CIRCUITS

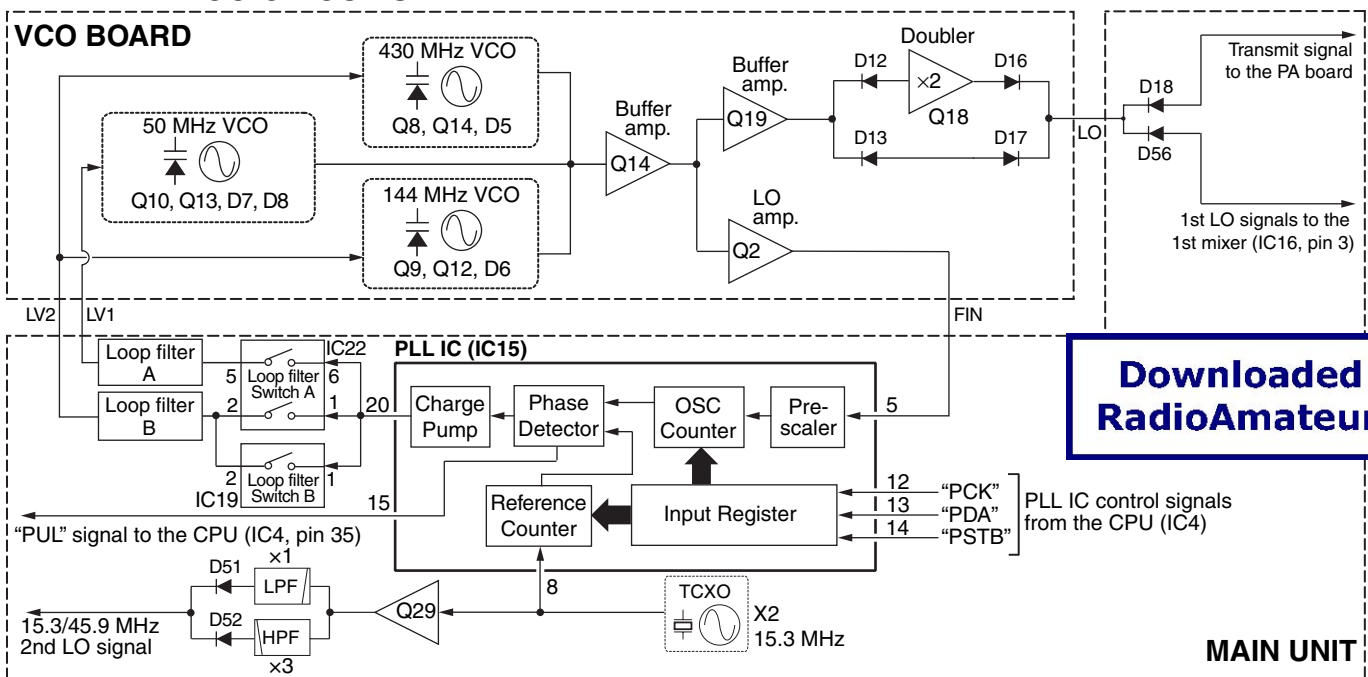

**Downloaded by  
RadioAmateur.EU**

**MAIN UNIT**

## 4-4 PORT ALLOCATIONS

### 4-4-1 CPU (MAIN UNIT; IC4)

Pin No.	Port Name	Description
2	K2	Input port for [▲], [▼] keys.
3	K1	Input port for [BAND], [CALL] and [V/M] keys.
4	RSSI	Input port for RSSI signal for the S-meter indicator from FM IF IC (IC15, pin 12).
5	VIN	Input port for voltage detection of attached battery pack.
6	CTONE	Input port for WX signal.
7	RTONE	Input port for CTCSS/DTCS signal.
14	ESIO	I/O port for EEPROM (IC1) data.
15	ECK	I/O port for the EEPROM (IC1) clock.
25	POWER	Input port for [PWR] key (S6). LOW: When the key is pushed.
26	DSTB	Outputs strobe signal to the D/A converter (IC13, pin 8).
28	CLS	Outputs clock sift signal to the clock frequency shift circuit (Q5).
29	VSTB	Outputs VOL strobe signal to the electronic VR (IC7, pin 14).
32	PDA	Outputs serial data to the PLL IC (IC18, pin 13), electronic VR (IC7, pin 16) and D/A converter (IC13, pin 6).
33	PSTB	Outputs PLL strobe signal to the PLL IC (IC18, pin14).
34	PCK	Outputs serial clock signal to the PLL IC (IC18, pin 12), electronic VR (IC7, pin 15) and D/A converter (IC13, pin 7).
35	PUL	Inputs PLL unlock signal ("PUL") from PLL IC (IC18, pin15).
41	LEDR	Outputs TX indicator LED (DS8; Red) control signal to the LED driver (Q49). "High": While transmitting.
42	LEDG	Outputs RX indicator LED (DS8; Green) control signal to the LED driver (Q49). "High": While receiving.
43	UHFC	Outputs UHF RF circuit control signal to the band selector (Q36). "High": While receiving on the UHF band.
44	R3C	Outputs receive circuit control signal to R3V regulator (Q6). "High": While receiving.
45	WFM	Outputs receiving mode (FM/WFM) switching signal to the FM/WFM switches (Q16, Q17, Q51, Q52). "Low": While receiving in FM mode.
46	AM	Outputs receiving mode (AM/FM) switching signal to the AM demodulator switch (Q18) and AF switch (IC14). "High": While receiving in AM mode.
47	NOISE	Inputs "NOISE" signal from the FM IF IC (IC15, pin 13).
48	DTCS	Outputs DTCS filter control signal to the DTCS filter (Q41).
49	TCON	Outputs tone filter control (IC5) signal to the CTCSS filter switch (Q8).

Pin No.	Port Name	Description
51	VHFC	Outputs VHF RF circuit control signal to the band selector (Q36). "High": While receiving on the VHF band (76–300 MHz).
52	PCON	Outputs +3V line control signal to the +3V regulator (IC10). "High": While the transceiver's power is ON.
53	+3SC	Outputs +3S line control signal to the +3S regulator (Q3, Q4).
54	TXC	Outputs transmit circuits control signal to T3 regulator circuit (Q24–Q27). "High": While transmitting.
55	BEEP	<ul style="list-style-type: none"> <li>• While receiving, outputs beep sound to the electric volume (IC7, pin6).</li> <li>• While transmitting, outputs 1750 Hz tone signal to the microphone amplifier circuit (IC8, pin 9).</li> </ul>
56	TXU	Outputs UHF TX circuit control signal to TX band switch (Q27). "High": While transmitting on UHF band.
57	TXV	Outputs VHF TX circuits control signal to TX band switch (Q27). "High": While transmitting on VHF band.
58	VSHIFT	Outputs oscillating frequency shift circuit (VCO BOARD; Q5, D2–D4) control signal. "High": D2–D4 are ON, and the oscillating frequency is shifts down.
59	DBL2	Outputs doubler switches (VCO BOARD; D13, D17) control signal. "High": While receiving 500 MHz and below.
60	DBL1	Outputs doubler switches (VCO BOARD; D12, D16) control signal. "Low": While receiving 500 MHz and above.
61	ATT	Outputs attenuator control signal to the attenuator controller (Q40). "High": While attenuator is activated.
63	HFC	Outputs HF RF circuit control signal to the HF band selector (Q35).
64	BCC	Outputs 0.5–30MHz receive circuit control signal to the HF band selector (Q35).
65	V3C	Outputs 430 MHz VCO control signal to the 430 MHz VCO switch (VCO BOARD; Q3).
66	V2C	Outputs 144 MHz VCO control signal to the 144 MHz VCO switch (VCO BOARD; Q3).
67	V1C	Outputs 50 MHz VCO control signal to the 50 MHz VCO switch (VCO BOARD; Q4).
68	AFON	Outputs AF power amplifier (IC9) control signal to the AF power amplifier controller (Q46, Q47). "High": While the audio is emitted.
69	LIGHT	Outputs backlight control signal to the LCD backlight (PA BOARD; DS1) driver (Q22). "High": While the backlight is ON.
70	MMUTE	Outputs MIC line mute signal to the MIC mute switch (Q37). "High": MIC signal is muted.
71	800C	Outputs 500–999 MHz RF circuit control signal to the 800 MHz band selector (Q40).
73, 74	DUD, DCK	Input ports for [DIAL].

#### 4-4-1 CPU (MAIN UNIT; IC4)-continue

Pin No.	Port Name	Description
75	SQL	Input port for [SQL] key (S7). "Low": While [SQL] is pushed.
76	FUNC	Input port for [FUNC] key (PA BOARD; S1). "Low": While [FUNC] is pushed.
77	PTT	Input port for [PTT] key. (PA BOARD; S2) "Low": While [PTT] is pushed.
138	PSET	Outputs transmit power control signal to the TX power controller (IC17. pin 3).
139	TRAC	Outputs BPFs tracking control signal to the tracking varactor diodes driver (Q32).
141	CTCOUT	Outputs CTCSS/DTCS signal to the MIC line.
144	TEMP	Input port for internal temperature of the transceiver.

#### 4-4-2 D/A CONVERTER (MAIN UNIT; IC13)

Pin No.	Port Name	Description
1	FSET	Outputs reference frequency control signal to the TCXO (X2, pin 1).
2	MODSET	Outputs modulation level control signal to the modulation volume circuit (Q37).
3	DTCSET	Outputs DTCS modulation level control signal to the DTCS modulation volume circuit (Q48).

#### 4-5 POWER SUPPLY CIRCUITS

Line	Description
VCC	The same voltage as attached battery pack.
CPU3V	Common 3 V converted from VCC line at the CPU3 regulator (IC11). The converted voltage is applied to the CPU (IC4), Re-set IC (IC2), EEPROM (IC1), etc.
+3S	Common 3 V converted from VCCline at the +3S regulator (Q3, Q4) controlled by "+3SC" signal from CPU (IC4, pin 53) controlled by "PCON" signal from the CPU (IC4, pin 52). The converted voltage is applied to the electric volume (IC7), VCO BOARD, etc.
+3V	Common 3 V converted from VCCline at the +3V regulator (IC10, Q1). The converted voltage is applied to the R3v regulator (Q6), +10 V DC-DC up-converter (Q7, Q61, Q62, D3, X4), PLL IC (IC15), D/A converter (IC13), etc.
R3V	Receive 3 V controlled by R3V regulator (Q6) using "R3C" signal from the CPU (IC4, pin 44). The voltage is applied to the FM IF IC (IC15), 1st mixer (IC16), 1st IF amplifier (Q9), RF circuits, etc.
TX3	Transmit 3 V controlled by T3 regulator (Q24-Q26) using "TXC" signal from the CPU (IC4, pin 54). The controlled voltage is applied to the TX power controller IC17, Q31, Q50), pre-driver (PA BOARD; Q1), microphone amplifier (IC8), etc.
+10V	Common +10 V boosted at the +10V DC-DC up-converter (Q7, Q61, Q62, D3, X4). The boosted voltage is applied to the loop filters, tracking varactor diodes driver (Q32), etc.

# SECTION 5 ADJUSTMENT PROCEDURES

## 5-1 PREPARATION

When adjusting IC-E7, these test equipments and the JIG cable (see the illust below) are required.

### REQUIRED TEST EQUIPMENTS

EQUIPMENT	GRADE AND RANGE	EQUIPMENT	GRADE AND RANGE
RF power meter (terminated type)	Measuring range : 0.1–3 W Frequency range : 100–500 MHz Impedance : 50 Ω SWR : Less than 1.2 : 1	Standard signal generator (SSG)	Frequency range : 0.1–1300 MHz Output level : 0.1 μV to 32 mV (–127 to –17 dBm)
Frequency counter	Frequency range : 0.1–500 MHz Frequency accuracy: ±1 ppm or better Sensitivity : 100 mV or better	Oscilloscope	Frequency range : DC–20 MHz Measuring range : 0.01–20 V
FM deviation meter	Frequency range : 30–500 MHz Measuring range : 0 to ±10 kHz	AC millivoltmeter	Measuring range : 10 mV to 10 V
Audio generator	Frequency range : 300–3000 Hz Output level : 1–500 mV (–47 to 7 dBm)	External speaker	Input impedance : 8 Ω Capacity : More than 50 mW
		Attenuator	Power attenuation : 20 or 30 dB Capacity : More than 3 W

### CONNECTION

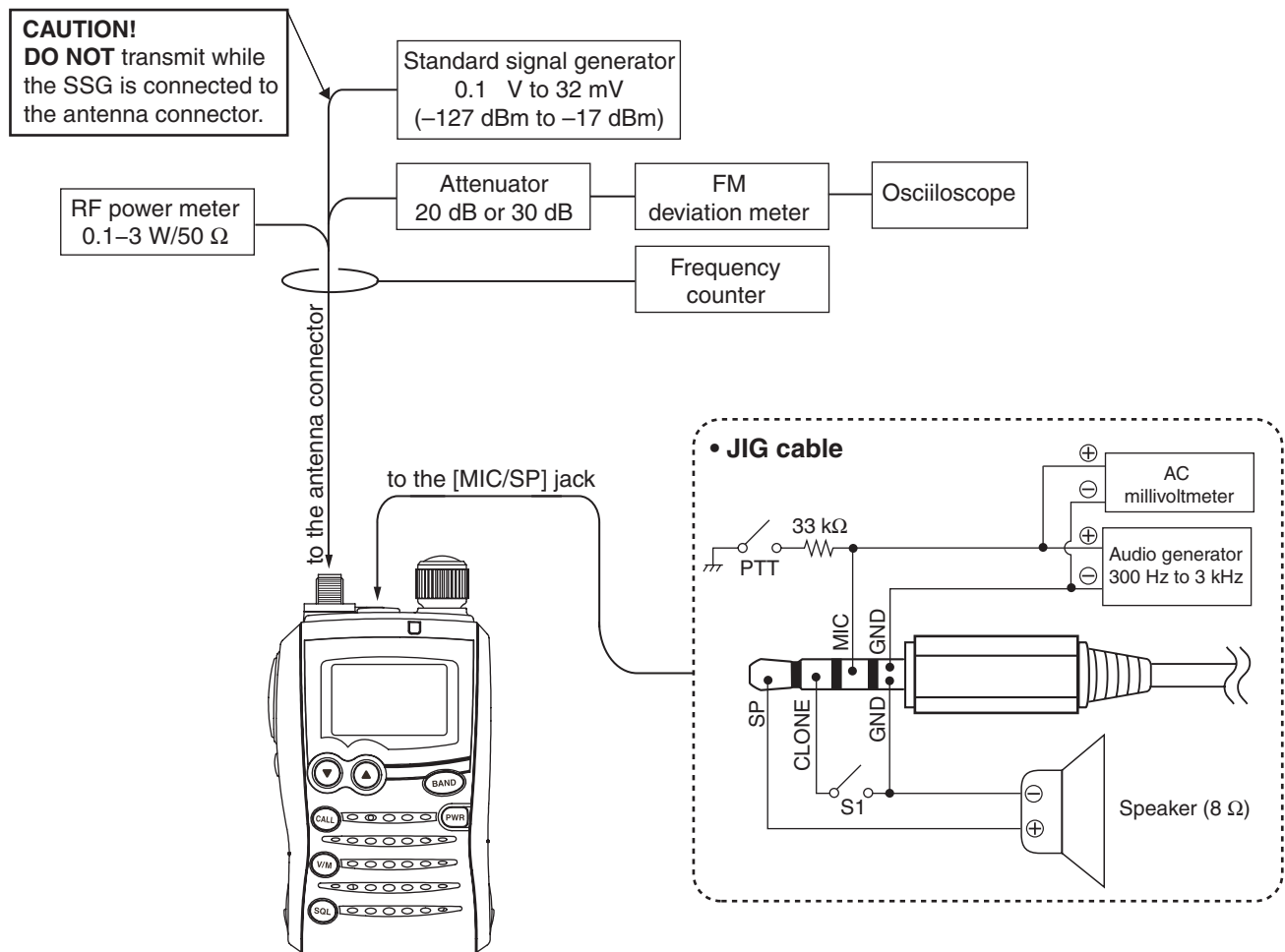



## ■ ENTERING ADJUSTMENT MODE

- ① Turn the power OFF.
- ② Connect the JIG cable (see page 5-1) to the [MIC/SP] jack.
- ③ Turn the "S1" of the JIG cable ON.
- ④ While pushing [FUNC], [BAND] and [▲] key, turn the power ON.
- ⑤ Turn the "S1" of the JIG cable OFF, then start the adjustment.

During adjustment mode, the function display shows the adjustment item, frequency, etc. as below.

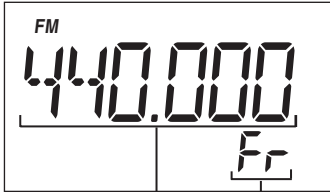

Adjustment frequency

Adjustment item

## ■ KEY ASSIGNMENTS FOR ADJUSTMENT MODE

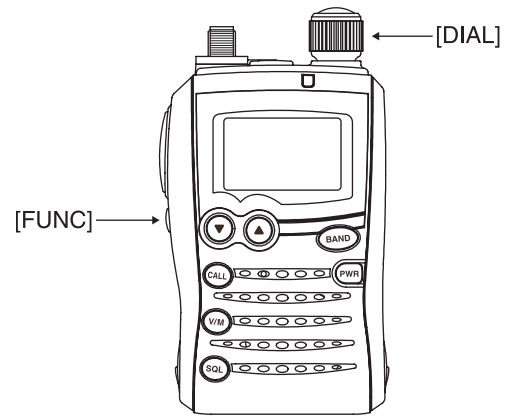

- : Selects the next adjustment item.
- : Selects the previous adjustment item.
- [DIAL] : Adjusts the value for the item manually.
- + : Adjusts the value for the item automatically.
- : Stores the set value.

**NOTE:** The set value storing is inhibited during transmit. Release PTT switch to return to receive first, then push this key to store the set value.

## ■ QUITTING ADJUSTMENT MODE

- Turn the power OFF.

## 5-2 FREQUENCY AND TRANSMIT ADJUSTMENT

• Set the specified value using [DIAL], and push [BAND] to store the set value. Then push [CALL] to move to the next adjustment item.

**NOTE:** "REFERENCE FREQUENCY" should be adjusted before "DEVIATION" and "RX SENSITIVITY," and "DEVIATION" should be adjusted before "DTCS BALANCE" (on the next page). Otherwise, these adjustments will not be adjusted properly.

ADJUSTMENT ITEM	ADJUSTMENT CONDITION	VALUE
REFERENCE FREQUENCY [Fr]	1 <ul style="list-style-type: none"> <li>Connect an RF power meter to the antenna connector.</li> <li>Loosely couple a frequency counter to the antenna connector.</li> <li>Transmitting</li> </ul>	440.00000 MHz
TX HIGH POWER (VHF/Low band) [PH1] PH1	1 <ul style="list-style-type: none"> <li>Connect an RF power meter to the antenna connector.</li> <li>Transmitting</li> </ul>	1.5 W
(VHF/Mid band) [PH2] PH2	2 <ul style="list-style-type: none"> <li>Transmitting</li> </ul>	
(VHF/High band) [PH3] PH3	3 <ul style="list-style-type: none"> <li>Transmitting</li> </ul>	
(UHF/Low band) [PH4] PH4	4 <ul style="list-style-type: none"> <li>Transmitting</li> </ul>	
(UHF/Mid band) [PH5] PH5	5 <ul style="list-style-type: none"> <li>Transmitting</li> </ul>	
(UHF/High band) [PH6] PH6	6 <ul style="list-style-type: none"> <li>Transmitting</li> </ul>	
TX LOW POWER (VHF/Low band) [PL1] PL1	1 <ul style="list-style-type: none"> <li>Transmitting</li> </ul>	0.1 W
(VHF/Mid band) [PL2] PL2	2 <ul style="list-style-type: none"> <li>Transmitting</li> </ul>	
(VHF/High band) [PL3] PL3	3 <ul style="list-style-type: none"> <li>Transmitting</li> </ul>	
(UHF/Low band) [PL4] PL4	4 <ul style="list-style-type: none"> <li>Transmitting</li> </ul>	
(UHF/Mid band) [PL5] PL5	5 <ul style="list-style-type: none"> <li>Transmitting</li> </ul>	
(UHF/High band) [PL6] PL6	6 <ul style="list-style-type: none"> <li>Transmitting</li> </ul>	
DEVIATION (VHF/Low band) [dE1] dE1	1 <ul style="list-style-type: none"> <li>Connect an audio generator to the [MIC/SP] jack through the JIG cable (see the page 5-1) and set as;               <ul style="list-style-type: none"> <li>Frequency : 1.0 kHz</li> <li>Level : 90 mVrms (-8 dBm)</li> </ul> </li> <li>Connect a modulation analyzer to the antenna connector through an attenuator and set as;               <ul style="list-style-type: none"> <li>LPF : 20 kHz</li> <li>HPF : OFF</li> <li>De-emphasis : OFF</li> <li>Detector : (P-P)/2</li> </ul> </li> <li>Transmitting</li> </ul>	±4.2 kHz
(VHF/Mid band) [dE2] dE2	2 <ul style="list-style-type: none"> <li>Transmitting</li> </ul>	
(VHF/High band) [dE3] dE3	3 <ul style="list-style-type: none"> <li>Transmitting</li> </ul>	
(UHF/Low band) [dE4] dE4	4 <ul style="list-style-type: none"> <li>Transmitting</li> </ul>	
(UHF/Mid band) [dE5] dE5	5 <ul style="list-style-type: none"> <li>Transmitting</li> </ul>	
(UHF/High band) [dE6] dE6	6 <ul style="list-style-type: none"> <li>Transmitting</li> </ul>	

## 5-3 SIGNALING AND RECEIVE ADJUSTMENT

• Set the specified value using [DIAL], and push [BAND] to store the set value. Then, push [CALL] to move to the next adjustment item.

**NOTE:** "DTCS BALANCE" should be adjusted before "CTCSS DEVIATION," and "RX SENSITIVITY" should be adjusted before "FM/WFM S-METER" (on the next page). Otherwise, these adjustments will not be adjusted properly.

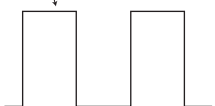
ADJUSTMENT ITEM	ADJUSTMENT CONDITION	VALUE
DTCS LEVEL (VHF) [dt1] <b>dt 1</b>	1 • Push [CALL] (No adjustment)	-
(UHF) [dt2] <b>dt 2</b>	2 • Push [CALL] (No adjustment)	
DTCS BALANCE (VHF) [db1] <b>db 1</b>	1 • No audio signal is applied to the [MIC/SP] jack. • Connect a modulation analyzer with an oscilloscope to the antenna connector through an attenuator, and set the modulation analyzer as; HPF : OFF      De-emphasis : OFF LPF : 20 kHz    Detector      : (P-P)/2 • Transmitting	Set to square wave form 
(UHF) [db2] <b>db 2</b>	2 • Transmitting	
CTCSS DEVIATION (VHF) [Ct1] <b>Ct 1</b>	1 • No audio signal is applied to the [MIC/SP] jack. • Set the modulation analyzer as the same as "DTCS BALANCE". • Transmitting	±0.75 kHz
(UHF) [Ct2] <b>Ct 2</b>	2 • Transmitting	
RX SENSITIVITY [t11] <b>t 1 1</b>	1 • Connect an SSG to the antenna connector and set as; Frequency : Specified frequency*    Level : 0 dBμt (-107 dBm) • Receiving	Push [FUNC]+[BAND] (Automatic adjustment)
[t21] <b>t 2 1</b>	2 • Set the SSG as; Frequency : Specified frequency* • Receiving	
[t31] <b>t 3 1</b>	3 • Set the SSG as; Frequency : Specified frequency* • Receiving	
[t12] <b>t 1 2</b>	4 • Set the SSG as; Frequency : Specified frequency* • Receiving	
[t22] <b>t 2 2</b>	5 • Set the SSG as; Frequency : Specified frequency* • Receiving	
[t32] <b>t 3 2</b>	6 • Set the SSG as; Frequency : Specified frequency* • Receiving	
[t13] <b>t 1 3</b>	7 • Set the SSG as; Frequency : Specified frequency* • Receiving	
[t23] <b>t 2 3</b>	8 • Set the SSG as; Frequency : Specified frequency* • Receiving	
[t33] <b>t 3 3</b>	9 • Set the SSG as; Frequency : Specified frequency* • Receiving	
[t14] <b>t 1 4</b>	10 • Set the SSG as; Frequency : Specified frequency* • Receiving	
[t24] <b>t 2 4</b>	11 • Set the SSG as; Frequency : Specified frequency* • Receiving	
[t34] <b>t 3 4</b>	12 • Set the SSG as; Frequency : Specified frequency* • Receiving	

†The output level of the standard signal generator (SSG) is indicated as the SSG's open circuit.

\*Displayed on the function display.

• RECEIVE ADJUSTMENT (continued)

ADJUSTMENT ITEM	ADJUSTMENT CONDITION		VALUE
[t44] E44	13	• Set the SSG as; Frequency : Specified frequency* • Receiving	Push [FUNC]+[BAND] (Automatic adjustment)
[t54] E54	14	• Set the SSG as; Frequency : Specified frequency* • Receiving	
[t64] E64	15	• Set the SSG as; Frequency : Specified frequency* • Receiving	Push [FUNC]+[BAND] (Automatic adjustment)
[t15] E15	16	• Set the SSG as; Frequency : Specified frequency* • Receiving	
[t25] E25	17	• Set the SSG as; Frequency : Specified frequency* • Receiving	
[t35] E35	18	• Set the SSG as; Frequency : Specified frequency* • Receiving	
[t45] E45	19	• Set the SSG as; Frequency : Specified frequency* • Receiving	
FM S-METER [S1] 51	1	• Set the SSG as; Frequency : Specified frequency* • Receiving	Push [BAND]
[S2] 52	2	• Set the SSG as; Frequency : Specified frequency* • Receiving	
[S3] 53	3	• Set the SSG as; Frequency : Specified frequency* • Receiving	
[S4] 54	4	• Set the SSG as; Frequency : Specified frequency* • Receiving	
[S5L] 55L	5	• Set the SSG as; Frequency : Specified frequency* • Receiving	
[S5H] 55H	6	• Set the SSG as; Frequency : Specified frequency* • Receiving	
[S6] 56	7	• Set the SSG as; Frequency : Specified frequency* • Receiving	Level : +5 dBμ† (–102 dBm)
WFM S-METER [S2] 52	1	• Set the SSG as; Frequency : Specified frequency* • Receiving	Level : +1 dBμ† (–106 dBm)
[S3] 53	2	• Set the SSG as; Frequency : Specified frequency* • Receiving	Level : –3 dBμ† (–104 dBm)
[S4] 54	3	• Set the SSG as; Frequency : Specified frequency* • Receiving	Push [BAND]
[S5L] 55L	4	• Set the SSG as; Frequency : Specified frequency* • Receiving	
[S5H] 55H	5	• Set the SSG as; Frequency : Specified frequency* • Receiving	
[S6] 56	6	• Set the SSG as; Frequency : Specified frequency* • Receiving	

†The output level of the standard signal generator (SSG) is indicated as the SSG's open circuit.

\*Displayed on the function display.

# SECTION 6 PARTS LIST

## • IC-E7

### [MAIN UNIT]

REF NO.	ORDER NO.	DESCRIPTION	M.	H/V LOCATION
IC1	1130012690	S.IC HN58X24256FPIE (SOP8)	T	11.5/61.9
IC2	1110006720	S.IC R3112N291A-TR-F	T	9.3/46.2
	1140013010	S.IC M30220FCRFP	T	27/53.5
IC5	1110006380	S.IC LM2904PWR	T	21.1/26.5
IC7	1130011860	S.IC SM6451BT-G-E2	B	22.7/10
IC8	1110006470	S.IC LMV324IPWR	T	15/21.8
IC9	1110002810	S.IC NJM2070M-TE1	B	26.5/59.9
IC10	1180002371	S.REG R1111N321B-TR-F	B	4.5/34.3
IC11	1180002371	S.REG R1111N321B-TR-F	T	36.5/61.9
IC12	1130007111	S.IC TC7W04FU (TE12L,F)	T	27.2/70.1
IC13	1190001830	S.IC BH2220FVM-TR	T	29.1/25
IC14	1130004201	S.IC TC4S66F	T	35.7/21.3
IC15	1110003201	S.IC TA31136FNG (EL)	B	34.4/20.4
		[ITR], [EXP], [FRA] only		
IC16	1110005230	S.IC µPC2757TB-E3	B	34.7/45.5
IC17	1110006490	S.IC LMV321IDCKR	T	7.4/62.7
IC18	1130012980	S.IC ADF4110BCPZ	B	9.9/17.1
IC19	1130007021	S.IC TC7S66F	B	7/8.2
IC22	1130009581	S.IC TC7W66FU	B	4/6.3
Q1	1590003230	S.TR UNR9113J-(TX)	T	37.5/59
Q2	1530003630	S.TR 2SC4617 TLS	B	3.5/2.7
Q3	1590001170	S.TR XP1501-(TX) AB	T	28/4.1
Q4	1510006671	S.TR 2SA1588 GR	T	28.4/6.7
Q5	1590003290	S.TR UNR9213J-(TX)	T	16.4/45.5
Q6	1510006671	S.TR 2SA1588 GR	T	25.2/6.1
Q7	1530003630	S.TR 2SC4617 TLS	B	28.1/36.8
Q8	1590003250	S.TR UNR9115J-(TX)	T	21.3/33.8
Q9	1530003260	S.TR 2SC5006-T1	B	32.3/31.2
Q10	1590001190	S.TR XP6501-(TX) AB	T	30.8/13.6
Q11	1560000541	S.TR 2SK880 Y	T	18.8/9.8
Q12	1530003630	S.TR 2SC4617 TLS	T	23/13.7
Q13	1530003630	S.TR 2SC4617 TLS	T	22.1/8.2
Q14	1510001100	S.TR 2SA1832-GR	T	39.8/50
Q16	1590002010	S.TR XP1114 (TX)	B	36.6/30.3
Q17	1590003290	S.TR UNR9213J-(TX)	T	34.3/3.9
Q18	1590003250	S.TR UNR9115J-(TX)	T	39.4/12.3
Q19	1590001190	S.TR XP6501-(TX) AB	T	35.7/14.9
Q20	1590001190	S.TR XP6501-(TX) AB	T	35/11.3
Q22	1530003630	S.TR 2SC4617 TLS	T	16.7/69.6
Q24	1590003280	S.TR UNR9211J-(TX)	T	25.2/16.9
Q25	1590001170	S.TR XP1501-(TX) AB	T	23.3/18.9
Q26	1510006620	S.TR 2SA1576 T106 S	T	20.7/19.1
Q27	1590001810	S.TR XP1113 (TX)	T	7/50.2
Q28	1590001451	S.FET 2SJ144-GR (TE85R,F) [UK] only	B	23.9/15.6
Q29	1530003630	S.TR 2SC4617 TLS	B	22.8/21.2
Q30	1590001650	S.TR XP4601 (TX)	T	31.8/71.5
Q31	1590002160	S.TR XP6401 (TX)	T	12.4/55.4
Q32	1590001650	S.TR XP4601 (TX)	B	25.2/36.6
Q34	1590001451	S.FET 2SJ144-GR (TE85R,F) [UK] only	T	16.3/13.2
Q35	1590001810	S.TR XP1113 (TX)	B	27.8/40.5
Q36	1590001810	S.TR XP1113 (TX)	B	4.2/37.3
Q37	1530003091	S.TR 2SC4213-B (TE85R,F)	T	18.2/15
Q38	1530003260	S.TR 2SC5006-T1	B	24.5/47.4
Q39	1530003591	S.TR 2SC5277-D2-TL-E	B	24.8/44.5
Q40	1590001810	S.TR XP1113 (TX)	T	39/44.5
Q41	1590003290	S.TR UNR9213J-(TX)	T	28.5/30.6
Q42	1530003611	S.TR FH102-TR-E	B	10.9/41
Q43	1530003611	S.TR FH102-TR-E	B	6.9/40.9
Q44	1590003290	S.TR UNR9213J-(TX)	B	3.1/57.5
Q45	1530003591	S.TR 2SC5277-D2-TL-E	B	16.1/45
Q46	1590001170	S.TR XP1501-(TX) AB	B	37.7/56.3
Q47	1510006620	S.TR 2SA1576 T106 S	B	36.8/59
Q48	1590001451	S.FET 2SJ144-GR (TE85R,F) [UK] only	T	31.1/18.9
Q49	1590002700	S.TR XP4214 (TX)	T	35/71.5
Q50	1590003390	S.TR UNR9215J-(TX)	T	12.6/52.8
Q51	1590002010	S.TR XP1114 (TX)	B	27.4/25
Q52	1590003290	S.TR UNR9213J-(TX)	B	24.6/27.7
Q54	1560000541	S.TR 2SK880 Y	T	19.4/7.2
Q56	1530003630	S.TR 2SC4617 TLS	T	20.8/4
Q59	1590003230	S.TR UNR9113J-(TX)	T	16.3/4.9
Q60	1590001680	S.TR XP1110 (TX)	T	23.2/4.1
Q61	1530003630	S.TR 2SC4617 TLS	B	19.9/27.2
Q62	1530003630	S.TR 2SC4617 TLS	B	22.4/25
D3	1790001790	S.DIO RB876W TL	B	23.8/31.1
D4	1790001790	S.DIO RB876W TL	B	25.8/31.1
D5	1750000940	S.DIO ISS400 TE61	T	27.5/11.1
D6	1730002320	S.ZEN MA8051-M (TX)	B	14.9/26.1
D9	1790001240	S.DIO MA2S728-(TX)	T	32.9/9.7
D10	1750001070	S.DIO DAN235ETL	T	30.6/8.3
D11	1750000940	S.DIO ISS400 TE61	T	19/69
D12	1750001070	S.DIO DAN235ETL	T	39.5/16.9
D13	1790001250	S.DIO MA2S111-(TX)	B	29.2/30.3
D14	1750001070	S.DIO DAN235ETL	B	30.3/33.8
D16	1790001621	S.DIO 1SV308	B	31.2/47.8

### [MAIN UNIT]

REF NO.	ORDER NO.	DESCRIPTION	M.	H/V LOCATION
D17	1750001070	S.DIO DAN235ETL	B	37.2/41.9
D18	1750001070	S.DIO DAN235ETL	B	16.1/22.3
D21	1790001621	S.DIO 1SV308	B	22/40
D22	1790001621	S.DIO 1SV308	B	17/34.6
D23	1790001621	S.DIO 1SV308	B	30.1/45.5
D24	1750000940	S.DIO ISS400 TE61	B	25.4/38.5
D25	1790001590	S.DIO MA6S718 (TX)	B	25.3/40.5
D26	1750000721	S.VCP HVC375BTRF-E	B	11.9/34
D27	1790001260	S.DIO MA2S077-(TX)	B	19.7/37.8
D28	1720000840	S.VCP HVD328CKRU-E	B	16.8/38.5
D29	1750000520	S.DIO DAN222TL	B	30.2/43.8
D30	1750001070	S.DIO DAN235ETL	B	21.3/47
D31	1720000840	S.VCP HVD328CKRU-E	B	14.8/37.7
D32	1750000721	S.VCP HVC375BTRF-E	B	7.4/33.6
D33	1720000840	S.VCP HVD328CKRU-E	B	21.1/43.2
D34	1790001621	S.DIO 1SV308	B	7.8/55.9
D35	1790001621	S.DIO 1SV308	B	11.2/53.2
D36	1790001260	S.DIO MA2S077-(TX)	B	9.4/38.9
D37	1790001621	S.DIO 1SV308	B	2.7/55.7
D38	1790001621	S.DIO 1SV308	B	10.7/58.7
D39	1720000840	S.VCP HVD328CKRU-E	B	16.8/47.6
D40	1720000840	S.VCP HVD328CKRU-E	B	18.2/42.8
D41	1790001621	S.DIO 1SV308	B	5.6/57.8
D43	1750001070	S.DIO DAN235ETL	B	18.3/51.1
D44	1790001621	S.DIO 1SV308	B	19.6/56.1
D45	1790001621	S.DIO 1SV308	B	5.1/63.5
D46	1790001621	S.DIO 1SV308	B	12.8/49.7
D50	1750000370	S.DIO DA221 TL	B	27.2/51.5
D51	1790001621	S.DIO 1SV308	B	31/21
D52	1790001621	S.DIO 1SV308	B	28.9/20.2
D53	1790001621	S.DIO 1SV308	B	8.6/45.4
D54	1790001621	S.DIO 1SV308	B	14.5/52.8
D55	1750000711	S.VCP HVC350BTRF-E	B	3.7/44.6
F11	2020002170	S.CER ELFY450E	B	31.8/8.5
F12	2020002200	S.CER SFEC314M8DA0001	B	31.2/38.5
F13	2010002670	S.XTL FL-393 (46.350 MHz)	B	36.5/35.5
X1	6050012240	S.XTL CR-813 (7.325 MHz)	T	13.7/48.2
X2	6050012170	S.XTL CR-807 (15.3 MHz)	B	11.1/21.6
X3	6070000190	S.DCR CDBCB450KCA24-R0	B	37.7/27.7
X4	6060000800	S.CER CSTCR6M75G53	B	20/30.7
L1	6200003640	S.COL MLF1608E 100K-T	B	16.8/27.5
L2	6200005500	S.COL NL 322522T-471J	B	39.1/13.1
L3	6200007170	S.COL MLF1608A 3R3K-T	B	32.4/28.6
L4	6200002040	S.COL NL 252018T-J	B	27/47.8
L5	6200003540	S.COL MLF1608D R22K-T	B	24/19.1
L6	6200003630	S.COL MLF1608D R68K-T	B	26.1/21.3
L7	6200004660	S.COL MLF1608A 1R8K-T	B	30.9/41.2
L8	6200005641	S.COL ELJRE 6N8ZFA	B	31.9/46.5
L9	6200005721	S.COL ELJRE 33NGFA	B	26.5/44.8
L10	6200011590	S.COL LQW18AN39NG00D	B	17.9/38.5
L11	6200011650	S.COL LQW18AN68NG00D	B	19/36.5
L12	6200008530	S.COL 0.30-1.0-4-TR 12N	B	8.8/49.9
L13	6200009220	S.COL LQW18AN15NG00D	B	10/33.4
L14	6200009110	S.COL 0.30-0.9-2-TR 4.1N	B	6.2/52.6
L15	6200006040	S.COL LQP18MN5N6C02D	B	22.2/43.3
L16	6200004590	S.COL MLF1608D R18K-T	B	7.8/58.4
L17	6200004590	S.COL MLF1608D R18K-T	B	10.9/50.9
L18	6200010210	S.COL C2012C-22NG-A	B	6/55.3
L19	6200010000	S.COL C2012C-56NG-A	B	12.1/55.9
L20	6200003540	S.COL MLF1608D R22K-T	B	18.9/48.7
L21	6200005200	S.COL ELJNC R68K-F	B	18.8/45.1
L22	6200011590	S.COL LQW18AN39NG00D	B	12.8/38.9
L23	6200010910	S.COL LQW18AN56NG00D	B	10.5/37.7
L24	6200004930	S.COL MLF1608E 8R2K-T	B	16.6/51.3
L25	6200009220	S.COL LQW18AN15NG00D	B	7/38
L26	6200008220	S.COL 0.40-1.4-5-TR 21N	B	5.2/59.7
L27	6200006040	S.COL LQP18MN5N6C02D	B	17/41.7
L28	6200005721	S.COL ELJRE 33NGFA	B	15.2/42.4
L29	6200008170	S.COL 0.35-1.6-8-TR 54N	B	16.2/56
L30	6200008270	S.COL 0.26-1.0-5-TR 17N	B	7.4/62.8
L31	6200008260	S.COL 0.30-1.7-8-TR 60N	B	16.2/59.4
L32	6200009531	S.COL ELJRE R15GFA	B	21.2/59.8
L33	6200008190	S.COL 0.25-1.9-8-TR 80N	B	10.3/62.4
L34	6200009571	S.COL ELJRE R12GFA	B	19.4/60.6
L36	6200011580	S.COL LQW18AN33NG00D	B	6.1/43.7
L37	6200005671	S.COL ELJRE 12NGFA	B	14.9/49.4
L38	6200008220	S.COL 0.40-1.4-5-TR 21N	B	6.5/65.5
L39	6200008190	S.COL 0.25-1.9-8-TR 80N	B	11.5/65.8
L40	6200005661	S.COL ELJRE 10NGFA	B	12.7/51.9
L41	6200005661	S.COL ELJRE 10NGFA	T	10.9/72.6
L42	6200008700	S.COL 0.30-0.9-6-TR 17.5N	B	10.5/68.7
L43	6200003630	S.COL MLF1608D R68K-T	B	24.3/22.6

M.=Mounted side (T: Mounted on the Top side, B: Mounted on the Bottom side)  
S.=Surface mount



[MAIN UNIT]

REF NO.	ORDER NO.	DESCRIPTION	M.	H/V LOCATION
L44	6200006981	S.COL ELJRE R10GFA	B	10.8/43.9
L101	6200003640	S.COL MLF1608E 100K-T	T	9.3/53.1
L102	6200004480	S.COL MLF1608B R82K-T	T	8.6/58.5
L103	6200005560	S.COL ELJSC K-F	B	30.1/27.8
L104	6200009270	S.COL MLF2012K 560K-T	B	19.6/25.1
L105	6200003640	S.COL MLF1608E 100K-T	B	33.6/57.6
L106	6200011590	S.COL LQW18AN39NG00D	B	4.9/44.6
R1	7030005050	S.RES ERJ2GEJ 103 X (10 kΩ)	B	6/13.6
R2	7030005050	S.RES ERJ2GEJ 103 X (10 kΩ)	B	22.4/58.8
R3	7030005050	S.RES ERJ2GEJ 103 X (10 kΩ)	B	3.1/40.5
R4	7030005070	S.RES ERJ2GEJ 683 X (68 kΩ)	T	36/64.1
R5	7030006610	S.RES ERJ2GEJ 394 X (390 kΩ)	T	11.6/27
R6	7030005100	S.RES ERJ2GEJ 154 X (150 kΩ)	B	2/19.6
R7	7030005120	S.RES ERJ2GEJ 102 X (1 kΩ)	B	2/3
R8	7030005310	S.RES ERJ2GEJ 124 X (120 kΩ)	T	36/65
R9	7030005240	S.RES ERJ2GEJ 473 X (47 kΩ)	B	23.3/60.4
R10	7030005240	S.RES ERJ2GEJ 473 X (47 kΩ)	B	23.3/58.8
R11	7030005240	S.RES ERJ2GEJ 473 X (47 kΩ)	B	23.3/57.2
R12	7030005310	S.RES ERJ2GEJ 124 X (120 kΩ)	T	29.6/29
R13	7030005570	S.RES ERJ2GEJ 820 X (82 Ω)	T	29.5/32.2
R14	7510001770	S.TMR NTCG10 4LH 473JT	B	24.6/55.7
R15	7030005090	S.RES ERJ2GEJ 154 X (100 kΩ)	B	26.5/54.4
R16	7030005570	S.RES ERJ2GEJ 820 X (82 Ω)	B	8.6/34.9
R17	7030005120	S.RES ERJ2GEJ 102 X (1 kΩ)	T	15.1/61.4
R18	7030005120	S.RES ERJ2GEJ 102 X (1 kΩ)	T	16.8/58.6
R19	7030005120	S.RES ERJ2GEJ 102 X (1 kΩ)	T	15.9/58.1
R20	7030005100	S.RES ERJ2GEJ 154 X (150 kΩ)	B	12.5/42.6
R21	7030006610	S.RES ERJ2GEJ 394 X (390 kΩ)	B	12.7/41
R22	7030005570	S.RES ERJ2GEJ 820 X (82 Ω)	B	4.8/24.4
R23	7030005290	S.RES ERJ2GEJ 682 X (6.8 kΩ)	T	27.4/1.8
R24	7030007300	S.RES ERJ2GEJ 332 X (3.3 kΩ)	T	26.3/3.2
R25	7030007290	S.RES ERJ2GEJ 222 X (2.2 kΩ)	T	28.6/2.2
R26	7030010040	S.RES ERJ2GEJ-JPW	T	18.9/46.9
R27	7030005310	S.RES ERJ2GEJ 124 X (120 kΩ)	T	10.9/44.4
R28	7030005570	S.RES ERJ2GEJ 820 X (82 Ω)	B	2/18
R29	7030005240	S.RES ERJ2GEJ 473 X (47 kΩ)	T	30.7/5.8
R30	7030005060	S.RES ERJ2GEJ 333 X (33 kΩ)	T	29.8/3.4
R31	7030005240	S.RES ERJ2GEJ 473 X (47 kΩ)	T	27.9/8.4
R32	7030005040	S.RES ERJ2GEJ 472 X (4.7 kΩ)	T	29.1/8.7
R33	7030005120	S.RES ERJ2GEJ 102 X (1 kΩ)	B	25.3/54.5
R34	7030005090	S.RES ERJ2GEJ 104 X (100 kΩ)	B	28.3/35.3
R35	7030005050	S.RES ERJ2GEJ 103 X (10 kΩ)	T	16.9/48.4
R36	7030010040	S.RES ERJ2GEJ-JPW	T	16/48.4
R37	7030005240	S.RES ERJ2GEJ 473 X (47 kΩ)	T	16.3/49.9
R38	7030005240	S.RES ERJ2GEJ 473 X (47 kΩ)	T	6.6/45
R39	7030005240	S.RES ERJ2GEJ 473 X (47 kΩ)	T	4.7/45
R40	7030005160	S.RES ERJ2GEJ 105 X (1 MΩ)	T	19.5/33.7
R41	7030005170	S.RES ERJ2GEJ 474 X (470 kΩ)	T	18.4/32.5
R43	7030005120	S.RES ERJ2GEJ 102 X (1 kΩ)	B	4.9/27.1
R44	7030005120	S.RES ERJ2GEJ 102 X (1 kΩ)	B	4/27.3
R49	7030005070	S.RES ERJ2GEJ 683 X (68 kΩ)	T	22.1/22.2
R54	7030005120	S.RES ERJ2GEJ 102 X (1 kΩ)	B	7.1/13.6
R55	7030005120	S.RES ERJ2GEJ 102 X (1 kΩ)	B	8/13.5
R56	7030006610	S.RES ERJ2GEJ 394 X (390 kΩ)	T	27.8/16.3
R57	7030008290	S.RES ERJ2GEJ 183 X (18 kΩ)	T	27.8/15.4
R58	7030005120	S.RES ERJ2GEJ 102 X (1 kΩ)	B	10.2/13.8
R59	7030005090	S.RES ERJ2GEJ 104 X (100 kΩ)	B	11.8/13.7
R60	7030007320	S.RES ERJ2GEJ 225 X (2.2 MΩ)	T	28.6/18.4
R61	7030005040	S.RES ERJ2GEJ 472 X (4.7 kΩ)	T	27.9/14.5
R62	7030007320	S.RES ERJ2GEJ 225 X (2.2 MΩ)	T	29.1/14.4
R63	7030008300	S.RES ERJ2GEJ 184 X (180 kΩ)	T	29.2/12.2
R64	7030008300	S.RES ERJ2GEJ 184 X (180 kΩ)	T	29.9/15.9
R65	7030005170	S.RES ERJ2GEJ 474 X (470 kΩ)	T	30.2/17.3
R66	7030008280	S.RES ERJ2GEJ 271 X (270 Ω)	B	13.3/16.7
R67	7030005090	S.RES ERJ2GEJ 104 X (100 kΩ)	T	31.1/16.4
R68	7030008410	S.RES ERJ2GEJ 392 X (3.9 kΩ)	T	17.8/7.8
R69	7030007340	S.RES ERJ2GEJ 153 X (15 kΩ)	T	32.3/15.9
R70	7030005160	S.RES ERJ2GEJ 105 X (1 MΩ)	T	27.2/13.3
R71	7030005080	S.RES ERJ2GEJ 823 X (82 kΩ)	T	30.1/10.7
R72	7030005040	S.RES ERJ2GEJ 472 X (4.7 kΩ)	T	12.4/10.5
R73	7030008300	S.RES ERJ2GEJ 184 X (180 kΩ)	T	25.5/10.6
R74	7030005290	S.RES ERJ2GEJ 682 X (6.8 kΩ)	T	21.3/6.2
R75	7030005170	S.RES ERJ2GEJ 474 X (470 kΩ)	T	24.5/13.1
R76	7030005290	S.RES ERJ2GEJ 682 X (6.8 kΩ)	T	22.2/6.2
R77	7030005530	S.RES ERJ2GEJ 100 X (10 Ω)	T	23.5/11.7
R78	7030008010	S.RES ERJ2GEJ 123 X (12 kΩ)	T	21.3/12.7
R79	7030009270	S.RES ERJ2GEJ 821 X (820 Ω)	T	21.3/13.9
R80	7030007340	S.RES ERJ2GEJ 153 X (15 kΩ)	T	21.6/10.1
R81	7030008410	S.RES ERJ2GEJ 392 X (3.9 kΩ)	T	20.7/9.4
R82	7030005160	S.RES ERJ2GEJ 105 X (1 MΩ)	T	7.3/60.7
R83	7030005050	S.RES ERJ2GEJ 103 X (10 kΩ)	T	5.3/62.2
R84	7030005110	S.RES ERJ2GEJ 224 X (220 kΩ)	T	14.9/62.9
R85	7030005170	S.RES ERJ2GEJ 121 X (120 Ω)	B	28.7/54.5
R86	7030005120	S.RES ERJ2GEJ 102 X (1 kΩ)	T	28/32.8
R87	7030008410	S.RES ERJ2GEJ 392 X (3.9 kΩ)	T	25.5/35.8
R88	7030007340	S.RES ERJ2GEJ 153 X (15 kΩ)	T	26.1/28.7
R89	7030006610	S.RES ERJ2GEJ 394 X (390 kΩ)	T	24.5/28.7
R90	7030005530	S.RES ERJ2GEJ 100 X (10 Ω)	B	26.9/64.3
R91	7030005040	S.RES ERJ2GEJ 472 X (4.7 kΩ)	T	23.3/26.3
R92	7030005060	S.RES ERJ2GEJ 333 X (33 kΩ)	T	14.9/28
R93	7510001480	S.TMR NTCG10 3NH 681JT	B	14/10.8
R94	7030005010	S.RES ERJ2GEJ 681 X (680 Ω)	T	32/23.4
R95	7030005240	S.RES ERJ2GEJ 473 X (47 kΩ)	B	2.4/38.9
R96	7030005240	S.RES ERJ2GEJ 473 X (47 kΩ)	T	14.7/59.2

[MAIN UNIT]

REF NO.	ORDER NO.	DESCRIPTION	M.	H/V LOCATION
R97	7030005050	S.RES ERJ2GEJ 103 X (10 kΩ)	T	14.6/57.7
R101	7030005120	S.RES ERJ2GEJ 102 X (1 kΩ)	B	24.8/52.7
R104	7030005030	S.RES ERJ2GEJ 152 X (1.5 kΩ)	T	37.2/17
R105	7030004980	S.RES ERJ2GEJ X (100 Ω)	T	38.2/11.2
R106	7030010040	S.RES ERJ2GEJ-JPW [EUR], [ITR], [FRA] only [UK] only	T	39.7/57.8
R107	7030010040	S.RES ERJ2GEJ-JPW	T	39.7/56.9
R108	7030007060	S.RES ERJ2GEJ 684X (680 kΩ)	T	35.8/16.8
R109	7030005220	S.RES ERJ2GEJ 223 X (22 kΩ)	T	37.6/14.8
R110	7030010040	S.RES ERJ2GEJ-JPW [ITR], [FRA] only	T	39.7/56
R111	7030010040	S.RES ERJ2GEJ-JPW [FRA] only	T	39.7/55.1
R112	7030010040	S.RES ERJ2GEJ-JPW	B	34.5/51.3
R113	7030010040	S.RES ERJ2GEJ-JPW [ITR], [FRA] only	B	33.2/51.3
R114	7030005160	S.RES ERJ2GEJ 105 X (1 MΩ)	T	37.3/14.8
R115	7030010040	S.RES ERJ2GEJ-JPW	B	31.9/51.3
R116	7030010040	S.RES ERJ2GEJ-JPW	B	30.6/51.3
R117	7030005090	S.RES ERJ2GEJ 104 X (100 kΩ)	T	24.6/72.8
R118	7030005240	S.RES ERJ2GEJ 473 X (47 kΩ)	T	34.9/13
R119	7030005090	S.RES ERJ2GEJ 104 X (100 kΩ)	T	23.7/72.8
R120	7030005090	S.RES ERJ2GEJ 104 X (100 kΩ)	T	36.9/12.7
R121	7030008370	S.RES ERJ2GEJ 561 X (560 Ω)	T	37.8/12.4
R122	7030005070	S.RES ERJ2GEJ 683 X (68 kΩ)	T	20.7/31.1
R123	7030005090	S.RES ERJ2GEJ 104 X (100 kΩ)	B	25.7/51.8
R124	7030008300	S.RES ERJ2GEJ 184 X (180 kΩ)	B	28.6/50.7
R125	7030007300	S.RES ERJ2GEJ 332 X (3.3 kΩ)	T	36.6/9.7
R126	7030005160	S.RES ERJ2GEJ 105 X (1 MΩ)	T	21.9/31.8
R127	7030005050	S.RES ERJ2GEJ 103 X (10 kΩ)	T	29.2/72.9
R128	7030005100	S.RES ERJ2GEJ 154 X (150 kΩ)	T	35.9/7
R129	7030005100	S.RES ERJ2GEJ 154 X (150 kΩ)	T	33.2/11
R130	7030005050	S.RES ERJ2GEJ 103 X (10 kΩ)	T	15.8/71.3
R131	7030005050	S.RES ERJ2GEJ 103 X (10 kΩ)	T	19.5/70.3
R132	7030005050	S.RES ERJ2GEJ 103 X (10 kΩ)	T	20.4/70.3
R133	7030008010	S.RES ERJ2GEJ 123 X (12 kΩ)	T	32.3/13.2
R134	7030005080	S.RES ERJ2GEJ 823 X (82 kΩ)	T	21.3/21.1
R135	7030005230	S.RES ERJ2GEJ 324 X (320 kΩ)	T	15.3/64.1
R157	7030005050	S.RES ERJ2GEJ 103 X (10 kΩ)	T	5.3/64.7
R168	7030005040	S.RES ERJ2GEJ 472 X (4.7 kΩ)	T	30.6/6.7
R169	7030005080	S.RES ERJ2GEJ 823 X (82 kΩ)	T	22.9/21.1
R170	7030007330	S.RES ERJ1WRSJR15U (0.15 Ω)	T	6.2/55.7
R171	7030005050	S.RES ERJ2GEJ 103 X (10 kΩ)	B	35.8/9.2
R172	7030005080	S.RES ERJ2GEJ 823 X (82 kΩ)	T	23.3/22.3
R173	7030007340	S.RES ERJ2GEJ 153 X (15 kΩ)	B	36.2/13.2
R174	7030005160	S.RES ERJ2GEJ 105 X (1 MΩ)	T	23.2/23.5
R175	7030005170	S.RES ERJ2GEJ 474 X (470 kΩ)	T	24.8/23.5
R176	7030005090	S.RES ERJ2GEJ 104 X (100 kΩ)	T	22.7/36.2
R177	7030005040	S.RES ERJ2GEJ 472 X (4.7 kΩ)	B	39.5/10.9
R178	7030005090	S.RES ERJ2GEJ 104 X (100 kΩ)	T	24.3/36.2
R179	7030005050	S.RES ERJ2GEJ 103 X (10 kΩ)	B	36.7/9.9
R180	7030005160	S.RES ERJ2GEJ 105 X (1 MΩ)	T	18.3/17
R181	7030005700	S.RES ERJ2GEJ 274 X (270 kΩ)	T	27.9/21.6
R182	7030007340	S.RES ERJ2GEJ 153 X (15 kΩ)	T	26.4/21.3
R183	7030005000	S.RES ERJ2GEJ 471 X (470 Ω)	T	23.4/16.8
R184	7030005000	S.RES ERJ2GEJ 471 X (470 Ω)	T	20.6/17.4
R185	7030005040	S.RES ERJ2GEJ 472 X (4.7 kΩ)	T	40.3/18.4
R186	7030005090	S.RES ERJ2GEJ 104 X (100 kΩ)	T	32.9/17.6
R187	7030005030	S.RES ERJ2GEJ 152 X (1.5 kΩ)	T	35.8/17.7
R188	7030010040	S.RES ERJ2GEJ-JPW	T	25.1/18.9
R190	7030009160	S.RES ERJ2GEJ 181 X (180 Ω)	B	33.4/29.3
R191	7030005030	S.RES ERJ2GEJ 152 X (1.5 kΩ)	B	37.7/17.5
R192	7030005240	S.RES ERJ2GEJ 473 X (47 kΩ)	T	34.2/18.6
R194	7030005290	S.RES ERJ2GEJ 682 X (6.8 kΩ)	B	8/24.4
R195	7030005120	S.RES ERJ2GEJ 102 X (1 kΩ)	B	33/32.7
R196	7030007340	S.RES ERJ2GEJ 153 X (15 kΩ)	T	33.4/22.2
R197	7030005030	S.RES ERJ2GEJ 152 X (1.5 kΩ)	T	33.4/21
R198	7030007340	S.RES ERJ2GEJ 153 X (15 kΩ)	B	30.6/30.3
R199	7030005110	S.RES ERJ2GEJ 224 X (220 kΩ)	B	30.5/31.2
R200	7030008300	S.RES ERJ2GEJ 184 X (180 kΩ)	B	22.7/19.7
R201	7030005170	S.RES ERJ2GEJ 474 X (470 kΩ)	T	32.2/11
R202	7030007320	S.RES ERJ2GEJ 225 X (2.2 MΩ)	B	25/17.5
R203	7030005050	S.RES ERJ2GEJ 103 X (10 kΩ)	B	29.3/32.4
R204	7030005000	S.RES ERJ2GEJ 471 X (470 Ω)	T	32/24.3
R205	7030008280	S.RES ERJ2GEJ 271 X (270 Ω)	B	25.1/19.9
R206	7030005050	S.RES ERJ2GEJ 103 X (10 kΩ)	B	30.9/35.7
R207	7030010040	S.RES ERJ2GEJ-JPW	B	31.8/34.8
R208	7030005050	S.RES ERJ2GEJ 103 X (10 kΩ)	B	31.8/33.1
R209	7030005090	S.RES ERJ2GEJ 104 X (100 kΩ)	B	30.4/23.3
R211	7030010040	S.RES ERJ2GEJ-JPW	B	25.5/24.6
R213	7030005050	S.RES ERJ2GEJ 103 X (10 kΩ)	B	33.3/41.4
R214	7030005010	S.RES ERJ2GEJ 681 X (680 Ω)	B	31.8/26
R217	7030005000	S.RES ERJ2GEJ 471 X (470 Ω)	B	35.3/41.4
R218	7030008400	S.RES ERJ2GEJ 392 X (3.9 kΩ)	T	10/57.8
R220	7030005050	S.RES ERJ2GEJ 103 X (10 kΩ)	B	33.9/42.8
R221	7030005050	S.RES ERJ2GEJ 103 X (10 kΩ)	B	37.5/40.5
R223	7030005080	S.RES ERJ2GEJ 823 X (82 kΩ)	B	23.3/37.3
R224	7030005220	S.RES ERJ2GEJ 223 X (22 kΩ)	B	22.9/36.1
R225	7030007290	S.RES ERJ2GEJ 222 X (2.2 kΩ)	B	15.4/20.3
R227	7030005050	S.RES ERJ2GEJ 103 X (10 kΩ)	B	31.9/40.5
R228	7030005050	S.RES ERJ2GEJ 103 X (10 kΩ)	T	17.3/11.3
R229	7030005160	S.RES ERJ2GEJ 105 X (1 MΩ)	T	18.6/11.4
R230	7			

[MAIN UNIT]

REF NO.	ORDER NO.	DESCRIPTION	M.	H/V LOCATION
R236	7030007290	S.RES ERJ2GEJ 222 X (2.2 kΩ)	B	28.7/43.5
R237	7030005240	S.RES ERJ2GEJ 473 X (47 kΩ)	T	12.8/25.1
R238	7030005240	S.RES ERJ2GEJ 473 X (47 kΩ)	T	14.4/25.1
R239	7030007300	S.RES ERJ2GEJ 332 X (3.3 kΩ)	T	15.5/11.1
R240	7030007570	S.RES ERJ2GEJ 122 X (1.2 kΩ)	T	12.4/11.4
R241	7030005050	S.RES ERJ2GEJ 103 X (10 kΩ)	B	21.6/37.3
R242	7030004990	S.RES ERJ2GEJ 221 X (220 Ω)	B	27.8/43.5
R243	7030004980	S.RES ERJ2GEJ X (100 Ω)	B	23.4/49.1
R244	7030007290	S.RES ERJ2GEJ 222 X (2.2 kΩ)	B	27.6/45.1
R245	7030005050	S.RES ERJ2GEJ 103 X (10 kΩ)	T	16.4/15.1
R246	7030005050	S.RES ERJ2GEJ 103 X (10 kΩ)	T	20.1/16.2
R247	7030005240	S.RES ERJ2GEJ 473 X (47 kΩ)	B	11.4/35.1
R248	7030004990	S.RES ERJ2GEJ 221 X (220 Ω)	B	23.3/42.4
R249	7030005170	S.RES ERJ2GEJ 474 X (470 kΩ)	T	12.6/14.2
R250	7030008010	S.RES ERJ2GEJ 123 X (12 kΩ)	T	11.6/17.6
R251	7030005060	S.RES ERJ2GEJ 333 X (33 kΩ)	T	20.1/14.6
R252	7030005050	S.RES ERJ2GEJ 103 X (10 kΩ)	B	23/46.7
R253	7030005240	S.RES ERJ2GEJ 473 X (47 kΩ)	B	24.4/45.9
R254	7030005090	S.RES ERJ2GEJ 104 X (100 kΩ)	B	16/37.2
R255	7030005240	S.RES ERJ2GEJ 473 X (47 kΩ)	T	12/15.5
R256	7030005050	S.RES ERJ2GEJ 103 X (10 kΩ)	T	13.7/17.2
R257	7030005000	S.RES ERJ2GEJ 471 X (470 Ω)	B	22.5/49.1
R258	7030005090	S.RES ERJ2GEJ 104 X (100 kΩ)	B	15.8/38.8
R259	7030005240	S.RES ERJ2GEJ 473 X (47 kΩ)	B	9.8/35.1
R260	7030005050	S.RES ERJ2GEJ 103 X (10 kΩ)	B	23.3/44
R261	7030005040	S.RES ERJ2GEJ 472 X (4.7 kΩ)	T	15.3/17.2
R262	7030004990	S.RES ERJ2GEJ 221 X (220 Ω)	B	8.9/60.1
R263	7030004990	S.RES ERJ2GEJ 221 X (220 Ω)	B	10.5/47.8
R264	7030007290	S.RES ERJ2GEJ 222 X (2.2 kΩ)	B	19.3/46.9
R265	7030005050	S.RES ERJ2GEJ 103 X (10 kΩ)	B	12.6/37.2
R266	7030005050	S.RES ERJ2GEJ 103 X (10 kΩ)	T	16/25.1
R267	7030009290	S.RES ERJ2GEJ 562 X (5.6 kΩ)	T	17.3/18.4
R268	7030009290	S.RES ERJ2GEJ 562 X (5.6 kΩ)	T	16.4/18.4
R269	7030005090	S.RES ERJ2GEJ 104 X (100 kΩ)	B	20.2/41.2
R270	7030005050	S.RES ERJ2GEJ 103 X (10 kΩ)	T	17.2/25.2
R271	7030005700	S.RES ERJ2GEJ 274 X (270 kΩ)	T	18.4/24.5
R272	7030008300	S.RES ERJ2GEJ 184 X (180 kΩ)	T	18.5/19.2
R273	7030005090	S.RES ERJ2GEJ 104 X (100 kΩ)	B	17.9/47.1
R274	7030005090	S.RES ERJ2GEJ 104 X (100 kΩ)	B	19.3/41.2
R275	7030005120	S.RES ERJ2GEJ 102 X (1 kΩ)	B	19.9/50.7
R276	7030005120	S.RES ERJ2GEJ 102 X (1 kΩ)	B	13.9/39.7
R277	7030005240	S.RES ERJ2GEJ 473 X (47 kΩ)	T	16/26
R278	7030005700	S.RES ERJ2GEJ 274 X (270 kΩ)	T	24.5/27.8
R279	7030007290	S.RES ERJ2GEJ 222 X (2.2 kΩ)	B	17.9/48.7
R280	7030005240	S.RES ERJ2GEJ 473 X (47 kΩ)	T	18.4/26.3
R281	7030004990	S.RES ERJ2GEJ 221 X (220 Ω)	B	13.2/44.7
R282	7030009290	S.RES ERJ2GEJ 562 X (5.6 kΩ)	B	14.2/24.7
R284	7030005000	S.RES ERJ2GEJ 471 X (470 Ω)	B	17.9/53.3
R285	7030007280	S.RES ERJ2GEJ 331 X (330 Ω)	B	8.9/41.7
R286	7030007270	S.RES ERJ2GEJ 151 X (150 Ω)	B	4.9/41
R287	7030007290	S.RES ERJ2GEJ 222 X (2.2 kΩ)	B	15.3/43.4
R288	7030005050	S.RES ERJ2GEJ 103 X (10 kΩ)	B	39.5/56.9
R289	7030007290	S.RES ERJ2GEJ 222 X (2.2 kΩ)	B	32.5/22.2
R290	7030005040	S.RES ERJ2GEJ 472 X (4.7 kΩ)	B	21.3/55.7
R291	7030004990	S.RES ERJ2GEJ 221 X (220 Ω)	B	14.4/45.8
R292	7030005090	S.RES ERJ2GEJ 104 X (100 kΩ)	T	40.3/53.3
R293	7030007300	S.RES ERJ2GEJ 332 X (3.3 kΩ)	T	31.6/22.2
R294	7030005040	S.RES ERJ2GEJ 472 X (4.7 kΩ)	B	10.7/42.8
R295	7030007290	S.RES ERJ2GEJ 222 X (2.2 kΩ)	B	7.5/42.9
R296	7030005050	S.RES ERJ2GEJ 103 X (10 kΩ)	B	37.2/51.8
R297	7030005240	S.RES ERJ2GEJ 473 X (47 kΩ)	T	28.8/21.6
R299	7030005120	S.RES ERJ2GEJ 102 X (1 kΩ)	B	39.1/54.1
R300	7030005220	S.RES ERJ2GEJ 223 X (22 kΩ)	B	13.9/46.7
R301	7030005050	S.RES ERJ2GEJ 103 X (10 kΩ)	B	13.2/47.6
R302	7030005170	S.RES ERJ2GEJ 474 X (470 kΩ)	T	30.3/21.7
R303	7030005160	S.RES ERJ2GEJ 105 X (1 MΩ)	T	30.2/20.8
R304	7030005290	S.RES ERJ2GEJ 682 X (6.8 kΩ)	B	10.3/45.2
R305	7030007340	S.RES ERJ2GEJ 153 X (15 kΩ)	B	9.1/44.1
R306	7030005290	S.RES ERJ2GEJ 682 X (6.8 kΩ)	B	8/44.1
R307	7030007340	S.RES ERJ2GEJ 153 X (15 kΩ)	B	7.1/44.1
R308	7030005120	S.RES ERJ2GEJ 102 X (1 kΩ)	B	15.5/47.6
R313	7030005050	S.RES ERJ2GEJ 103 X (10 kΩ)	B	37.5/54.1
R314	7030007340	S.RES ERJ2GEJ 153 X (15 kΩ)	T	40/51.5
R315	7030005120	S.RES ERJ2GEJ 102 X (1 kΩ)	T	40/52.4
R316	7030004990	S.RES ERJ2GEJ 221 X (220 Ω)	B	3/61.5
R317	7030007300	S.RES ERJ2GEJ 332 X (3.3 kΩ)	B	12/57.9
R318	7030007300	S.RES ERJ2GEJ 332 X (3.3 kΩ)	B	6.8/47.8
R319	7030005120	S.RES ERJ2GEJ 102 X (1 kΩ)	T	35.6/73.2
R320	7030005120	S.RES ERJ2GEJ 102 X (1 kΩ)	T	34/73.2
R321	7030005600	S.RES ERJ2GEJ 273 X (27 kΩ)	T	24.5/9.9
R322	7030005050	S.RES ERJ2GEJ 103 X (10 kΩ)	T	23.8/7.8
R323	7030005050	S.RES ERJ2GEJ 103 X (10 kΩ)	T	14.3/52
R324	7030004990	S.RES ERJ2GEJ 221 X (220 Ω)	B	29.6/24.4
R326	7030005050	S.RES ERJ2GEJ 103 X (10 kΩ)	B	7.6/20.5
R327	7030008410	S.RES ERJ2GEJ 392 X (3.9 kΩ)	T	16.9/7.8
R328	7030009290	S.RES ERJ2GEJ 562 X (5.6 kΩ)	T	19/4.4
R329	7030005290	S.RES ERJ2GEJ 682 X (6.8 kΩ)	T	19.4/2.3
R330	7030005120	S.RES ERJ2GEJ 102 X (1 kΩ)	T	19.5/5.3
R331	7030005220	S.RES ERJ2GEJ 223 X (22 kΩ)	T	19.1/3.5
R337	7030010040	S.RES ERJ2GE-JPW	T	17.5/6.3
R351	7410001130	S.ARY EXB28V102JX	T	32.8/43.1
R352	7410001130	S.ARY EXB28V102JX	T	21.6/42.9
R354	7410001130	S.ARY EXB28V102JX	T	10.6/49.2
R355	7410001130	S.ARY EXB28V102JX	T	35.1/44.6
R356	7030010040	S.RES ERJ2GE-JPW	T	34.1/1.5
R357	7030005050	S.RES ERJ2GEJ 103 X (10 kΩ)	B	27.2/19.3

[MAIN UNIT]

REF NO.	ORDER NO.	DESCRIPTION	M.	H/V LOCATION
R358	7030005050	S.RES ERJ2GEJ 103 X (10 kΩ)	B	30.5/18
R359	7030005040	S.RES ERJ2GEJ 472 X (4.7 kΩ)	B	30.8/19.3
R360	7030010040	S.RES ERJ2GE-JPW	B	8.7/32.8
R361	7030005050	S.RES ERJ2GEJ 103 X (10 kΩ)	B	8.7/46.7
R362	7030005580	S.RES ERJ2GEJ 560 X (56 Ω)	B	10.3/46.4
R363	7030005040	S.RES ERJ2GEJ 472 X (4.7 kΩ)	T	15.1/16.3
R364	7030008300	S.RES ERJ2GEJ 184 X (180 kΩ)	T	10.7/23.5
R365	7030005090	S.RES ERJ2GEJ 104 X (100 kΩ)	T	17.4/27.1
R366	7030005040	S.RES ERJ2GEJ 472 X (4.7 kΩ)	T	11.6/25.4
R367	7030007290	S.RES ERJ2GEJ 222 X (2.2 kΩ)	B	17.7/26.3
R368	7030005090	S.RES ERJ2GEJ 104 X (100 kΩ)	B	18.5/27.5
R369	7030005230	S.RES ERJ2GEJ 334 X (330 kΩ)	B	23.9/25.5
R370	7030005010	S.RES ERJ2GEJ 681 X (680 Ω)	B	11/23.8
R371	7030005120	S.RES ERJ2GEJ 102 X (1 kΩ)	B	13.4/53.3
R372	7030005050	S.RES ERJ2GEJ 103 X (10 kΩ)	B	6.8/27.7
R373	7030007340	S.RES ERJ2GEJ 153 X (15 kΩ)	B	29.4/56.7
R374	7030009140	S.RES ERJ2GEJ 272 X (2.7 kΩ)	T	14/11.7
R375	7030010040	S.RES ERJ2GE-JPW	B	7.4/39.1
R376	7030005240	S.RES ERJ2GEJ 473 X (47 kΩ)	B	3.5/42.5
R377	7030007290	S.RES ERJ2GEJ 222 X (2.2 kΩ)	T	26.5/19.8
R378	7030005120	S.RES ERJ2GEJ 102 X (1 kΩ)	T	8.8/49.2
R379	7030010040	S.RES ERJ2GE-JPW	B	13.5/17.9
C1	4550007260	S.TAN F931C475MAABMA	T	34/6
C3	4030017460	S.CER ECJ0EB1E102K	B	22.4/60.4
C4	4030016930	S.CER ECJ0EB1A104K	B	26.5/55.3
C5	4030017460	S.CER ECJ0EB1E102K	T	29.1/28.1
C7	4030016790	S.CER ECJ0EB1C103K	T	11.4/46.7
C8	4030017420	S.CER ECJ0EC1H470J	B	29.5/67.1
C9	4030016930	S.CER ECJ0EB1A104K	T	25.9/4.4
C11	4030016930	S.CER ECJ0EB1A104K	T	15.8/56.6
C12	4030017460	S.CER ECJ0EB1E102K	T	13.4/57.5
C13	4030017420	S.CER ECJ0EC1H470J	B	34.1/67.3
C14	4030017460	S.CER ECJ0EB1E102K	T	29.8/1.8
C15	4030016930	S.CER ECJ0EB1A104K	B	16.4/28.5
C16	4030017490	S.CER C1608 JB 1A 105K-T	B	20.9/23.5
C18	4030017460	S.CER ECJ0EB1E102K	T	17.3/59.7
C19	4030017460	S.CER ECJ0EB1E102K	B	13.9/40.9
C21	4030017460	S.CER ECJ0EB1E102K	T	18/59.1
C23	4030017460	S.CER ECJ0EB1E102K	T	15.8/59.7
C24	4030017490	S.CER C1608 JB 1A 105K-T	B	22.8/28.1
C25	4030017390	S.CER ECJ0EC1H180J	T	16.4/47
C26	4030017460	S.CER ECJ0EB1E102K	B	2/8.6
C27	4030017460	S.CER ECJ0EB1E102K	T	28.2/9.6
C28	4030017490	S.CER C1608 JB 1A 105K-T	B	22.9/32.8
C29	4030017460	S.CER ECJ0EB1E102K	T	30/30.6
C30	4030017490	S.CER C1608 JB 1A 105K-T	B	24.9/29.4
C31	4030017460	S.CER ECJ0EB1E102K	T	23.3/6.4
C32	4030017490	S.CER C1608 JB 1A 105K-T	B	25.5/32.8
C33	4030017460	S.CER ECJ0EB1E102K	T	17.9/45.4
C34	4030008680	S.CER C2012 JF 1C 105Z-T	B	27.6/31.9
C35	4030017460	S.CER ECJ0EB1E102K	T	27.3/9.6
C36	4030017460	S.CER ECJ0EB1E102K	T	36.2/59.8
C37	4550007660	S.TAN F931E105MAABMA	B	24.9/34.4
C38	4030016930	S.CER ECJ0EB1A104K	B	28/38.2
C39	4030017460	S.CER ECJ0EB1E102K	T	21.5/35.3
C40	4550006970	S.TAN TEESVA0G476M8R	B	35.7/65.1
C41	4030017460	S.CER ECJ0EB1E102K	T	23/33.8
C42	4550006250	S.TAN TEESVA 1A 106M8R	B	5.6/31.5
C44	4030017460	S.CER ECJ0EB1E102K	B	8.3/30.3
C45	4030017460	S.CER ECJ0EB1E102K	B	28.6/52.3
C46	4030016930	S.CER ECJ0EB1A104K	T	20/32.5
C47	4030017460	S.CER ECJ0EB1E102K	B	24.8/50.9
C48	4030017700	S.CER ECJ0EC1H151J	B	36.2/14.1
C49	4030017460	S.CER ECJ0EB1E102K	T	23.3/24.2
C50	4030016790	S.CER ECJ0EB1C103K	T	27/17.7
C51	4030016930	S.CER ECJ0EB1A104K	T	26.6/15.9
C52	4550007600	S.TAN F920J106MPABMA	T	12/13.4
C53	4030017420	S.CER ECJ0EC1H470J	B	7.5/11.8
C54	4030017420	S.CER ECJ0EC1H470J	B	15.2/12.6
C55	4030017760	S.CER ECJ0EB1H222K	T	27.7/18.4
C56	4030016970	S.CER ECJ0EB1C223K	T	26.1/14.5
C57	4030017420	S.CER ECJ0EC1H470J	B	13.7/11.6
C58	4030018140	S.CER ECJ0EB1H391K	T	28.6/17.2
C59	4030016930	S.CER ECJ0EB1A104K	T	26.3/13.3
C60	4030017460	S.CER ECJ0EB1E102K	B	6.2/11.5
C61	4030017450	S.CER ECJ0EB1E271K	T	29/16
C62	4030016790	S.CER ECJ0EB1C103K	B	6.2/12.4
C63	4030017710	S.CER ECJ0EC1H181J	T	28.3/12.4
C64	4030017740	S.CER ECJ0EB1E821K	T	31.1/15.5
C65	4030012600	S.CER C2012 JB 1A 105M-T	B	13.3/14.5
C66	4030017460	S.CER ECJ0EB1E102K	B	13.2/19.1
C67	4030017460	S.CER ECJ0EB1E102K	B	7.8/22.8
C68	4030016930	S.CER ECJ0EB1A104K	T	32.5/14.3
C69	4030016930	S.CER ECJ0EB1A104K	T	29.2/10.3
C70	4030017490	S.CER C1608 JB 1A 105K-T	T	31.1/10.8
C71	4030016930	S.CER ECJ0EB1A104K	T	20.4/12.7
C72	4340000260	S.MLR CPU 1C 104MA5	T	12.8/9.1
C73	4030016930	S.CER ECJ0EB1A104K	T	25.7/11.9
C74	4030016930	S.CER ECJ0EB1A1		



[MAIN UNIT]

REF NO.	ORDER NO.	DESCRIPTION	M.	H/V LOCATION
C82	4030016930	S.CER ECJ0EB1A104K	B	22.4/16.8
C83	4030017040	S.CER ECJ0EB1A333K	T	8/64.7
C84	4030016930	S.CER ECJ0EB1A104K	B	20.7/5.4
C85	4030017460	S.CER ECJ0EB1E102K	T	26.4/9.5
C86	4550007600	S.TAN F920J106MPABMA	B	19.1/9.9
C87	4030016930	S.CER ECJ0EB1A104K	T	24.3/8.7
C88	4030016930	S.CER ECJ0EB1A104K	T	25.5/9
C89	4030017040	S.CER ECJ0EB1A333K	T	26.9/33.7
C90	4550007600	S.TAN F920J106MPABMA	T	26.3/26.7
C91	4030016950	S.CER ECJ0EB1A473K	B	25.3/64.3
C93	4550006880	S.TAN TEESVD2 0J 157M12R	B	26.5/69.2
C94	4030017460	S.CER ECJ0EB1E102K	B	24.2/65.3
C95	4030016930	S.CER ECJ0EB1A104K	B	28.7/65.3
C96	4550006880	S.TAN TEESVD2 0J 157M12R	B	31.8/63.2
C97	4030017460	S.CER ECJ0EB1E102K	B	13.4/27.5
C98	4030017460	S.CER ECJ0EB1E102K	B	13.5/28.5
C99	4550007480	S.TAN F930J106MAABMA	B	37/15.6
C100	4030017460	S.CER ECJ0EB1E102K	T	4.9/63.4
C101	4030017460	S.CER ECJ0EB1E102K	T	15.1/53.6
C102	4030017460	S.CER ECJ0EB1E102K	T	14.2/53.3
C103	4030017040	S.CER ECJ0EB1A333K	T	6.4/60.7
C104	4030016930	S.CER ECJ0EB1A104K	T	7.1/64.7
C105	4030017460	S.CER ECJ0EB1E102K	B	26.3/53.4
C106	4030017460	S.CER ECJ0EB1E102K	T	9.5/51.4
C107	4030017460	S.CER ECJ0EB1E102K	T	10.4/51.4
C108	4030017460	S.CER ECJ0EB1E102K	T	11.3/51
C109	4030017460	S.CER ECJ0EB1E102K	B	27.8/53.7
C110	4030017460	S.CER ECJ0EB1E102K	T	8.6/51.8
C111	4030017460	S.CER ECJ0EB1E102K	T	7.6/48.4
C112	4030017460	S.CER ECJ0EB1E102K	T	40.3/13.9
C113	4550006250	S.TAN TEESVA 1A 106M8R	B	5.7/29.2
C114	4550006970	S.TAN TEESVA0G476M8R	T	40.4/60.8
C115	4030017460	S.CER ECJ0EB1E102K	T	38.8/60.5
C116	4030016930	S.CER ECJ0EB1A104K	T	38.1/17
C117	4030016790	S.CER ECJ0EB1C103K	T	37.6/15.7
C118	4030016790	S.CER ECJ0EB1C103K	T	37.6/13.9
C119	4550007480	S.TAN F930J106MAABMA	T	34.1/8.1
C120	4030017460	S.CER ECJ0EB1E102K	T	33.7/15.7
C121	4030017440	S.CER ECJ0EC1H221J	T	21.9/30.9
C122	4030017700	S.CER ECJ0EC1H151J	T	36.9/11.1
C123	4030017460	S.CER ECJ0EB1E102K	T	38.2/10.3
C124	4030017430	S.CER ECJ0EC1H1J	T	33.2/12.6
C125	4030016930	S.CER ECJ0EB1A104K	T	33.7/13.9
C126	4030017460	S.CER ECJ0EB1E102K	T	17.4/71.3
C127	4030016930	S.CER ECJ0EB1A104K	B	34/15.4
C128	4030016970	S.CER ECJ0EC1C223K	T	24.5/22.6
C129	4030017910	S.CER ECJ0EB1H152K	T	19.7/21.1
C130	4030016970	S.CER ECJ0EB1C223K	T	20.5/22.2
C131	4030018140	S.CER ECJ0EB1H391K	B	38.3/11.2
C132	4030016790	S.CER ECJ0EB1C103K	T	24.5/21.7
C133	4030016790	S.CER ECJ0EB1C103K	B	35.8/7.6
C134	4030016930	S.CER ECJ0EB1A104K	T	15.2/69.2
C135	4030017490	S.CER C1608 JB 1A 105K-T	T	24.4/25.2
C136	4030018140	S.CER ECJ0EB1H391K	B	40.5/16
C137	4030017720	S.CER ECJ0EB1H331K	T	22.7/35
C138	4030017720	S.CER ECJ0EB1H331K	T	23.6/35
C139	4030016790	S.CER ECJ0EB1C103K	B	36.6/11.5
C140	4030017460	S.CER ECJ0EB1E102K	T	25.3/15.4
C141	4030017460	S.CER ECJ0EB1E102K	B	37.9/10.1
C142	4030017460	S.CER ECJ0EB1E102K	T	19.2/17
C143	4030017460	S.CER ECJ0EB1E102K	B	14.5/20.4
C144	4030016930	S.CER ECJ0EB1A104K	T	38.7/18.4
C145	4030017460	S.CER ECJ0EB1E102K	T	21.8/17
C146	4030016790	S.CER ECJ0EB1C103K	B	14.5/22.6
C147	4030016930	S.CER ECJ0EB1A104K	B	31.4/15.8
C148	4030017460	S.CER ECJ0EB1E102K	T	23.8/15.6
C149	4030016930	S.CER ECJ0EB1A104K	B	38.9/17.1
C150	4030017730	S.CER ECJ0EB1E471K	T	34.2/16.8
C151	4030017460	S.CER ECJ0EB1E102K	B	33.4/25
C152	4030017730	S.CER ECJ0EB1E471K	T	34.2/17.7
C153	4030017460	S.CER ECJ0EB1E102K	B	33.7/31.2
C154	4550002980	S.TAN TEESVA 1C 225M8R	B	6.3/24.8
C155	4030017460	S.CER ECJ0EB1E102K	B	33/26.2
C156	4030017460	S.CER ECJ0EB1E102K	B	33/33.6
C157	4030016930	S.CER ECJ0EB1A104K	T	36.5/19.2
C158	4030016790	S.CER ECJ0EB1C103K	T	33.4/19.8
C159	4030017460	S.CER ECJ0EB1E102K	B	8/27.3
C160	4030016790	S.CER ECJ0EB1C103K	B	22.7/18.8
C161	4030016790	S.CER ECJ0EB1C103K	B	30.5/32.2
C162	4030016790	S.CER ECJ0EB1C103K	T	33.2/23.8
C163	4030017460	S.CER ECJ0EB1E102K	B	20.8/21.9
C164	4030017460	S.CER ECJ0EB1E102K	T	34.4/23.5
C165	4030016930	S.CER ECJ0EB1A104K	B	23.6/17.4
C168	4030016790	S.CER ECJ0EB1C103K	B	38.9/18
C169	4030017040	S.CER ECJ0EB1A333K	B	38.6/24
C170	4030017460	S.CER ECJ0EB1E102K	T	31.5/25.2
C171	4030016790	S.CER ECJ0EB1C103K	B	29.9/35.7
C172	4030017630	S.CER ECJ0EC1H120J	B	24.8/21.1
C175	4030017380	S.CER ECJ0EC1H050B	B	32.7/34.8
C177	4030017630	S.CER ECJ0EC1H120J	B	27.8/20.5
C178	4030017680	S.CER ECJ0EC1H820J	B	30.8/25.9
C179	4030017680	S.CER ECJ0EC1H820J	B	32.1/42.2
C180	4030016790	S.CER ECJ0EB1C103K	B	38.8/41.7
C182	4030016790	S.CER ECJ0EB1C103K	B	36.3/43.9
C183	4030016930	S.CER ECJ0EB1A104K	B	24.3/24.3
C184	4030017460	S.CER ECJ0EB1E102K	B	26/26.9

[MAIN UNIT]

REF NO.	ORDER NO.	DESCRIPTION	M.	H/V LOCATION
C186	4030016790	S.CER ECJ0EB1C103K	B	35.1/43.5
C187	4030017380	S.CER ECJ0EC1H050B	B	35.9/40.5
C189	4030017460	S.CER ECJ0EB1E102K	B	23.3/38.5
C190	4550007600	S.TAN F920J106MPABMA	T	13.9/13.8
C191	4030016930	S.CER ECJ0EB1A104K	B	33.3/47.6
C192	4030017460	S.CER ECJ0EB1E102K	T	11/53
C193	4030016930	S.CER ECJ0EB1A104K	T	18.2/12.6
C195	4030016930	S.CER ECJ0EB1A104K	B	23.3/39.4
C196	4550007600	S.TAN F920J106MPABMA	B	19.3/5.1
C197	4030017460	S.CER ECJ0EB1E102K	T	12.8/26
C198	4030016930	S.CER ECJ0EB1A104K	T	16.4/11.1
C199	4030016930	S.CER ECJ0EB1A104K	B	28.7/48.1
C200	4030016930	S.CER ECJ0EB1A104K	B	25.2/49.1
C201	4030017460	S.CER ECJ0EB1E102K	B	21.7/38.5
C202	4030017460	S.CER ECJ0EB1E102K	B	14.5/34.4
C203	4030017460	S.CER ECJ0EB1E102K	B	26.4/42.7
C204	4030017350	S.CER ECJ0EC1H020B	B	13.9/35.6
C205	4030017400	S.CER ECJ0EC1H220J	B	28.5/45.1
C207	4030017460	S.CER ECJ0EB1E102K	T	18.8/27.5
C208	4030017660	S.CER ECJ0EC1H330J	B	19.3/39.4
C209	4030018860	S.CER ECJ0EB0J105K	T	16.7/16.3
C210	4030017460	S.CER ECJ0EB1E102K	B	20.7/36.3
C211	4030017460	S.CER ECJ0EB1E102K	B	25.5/42.7
C212	4550006120	S.TAN TEESVA 0G 226M8R	B	9.4/26.2
C213	4030016930	S.CER ECJ0EB1A104K	B	24.3/49.1
C214	4030017750	S.CER ECJ0EB1E122K	T	12/18.8
C215	4030017460	S.CER ECJ0EB1E102K	B	11.4/36
C216	4030017440	S.CER ECJ0EC1H221J	B	16.9/36.2
C217	4030017460	S.CER ECJ0EB1E102K	B	24.2/42.7
C219	4030016790	S.CER ECJ0EB1C103K	T	12.5/17.6
C220	4030019030	S.CER GQM1882C1H220JB01D	B	5/51
C221	4030016930	S.CER ECJ0EB1A104K	B	22.6/47.9
C222	4030017530	S.CER ECJ0EC1H0R5B	B	9.8/36
C223	4030017510	S.CER ECJ0EC1H680J	B	9.5/53.5
C224	4550002980	S.TAN TEESVA 1C 225M8R	B	31/55.5
C225	4030017780	S.CER ECJ0EB1E472K	T	13.8/18.4
C226	4030019030	S.CER GQM1882C1H220JB01D	B	7.9/52.5
C227	4030017460	S.CER ECJ0EB1E102K	B	9.5/52.1
C228	4030017590	S.CER ECJ0EC1H070C	B	16/40.1
C229	4030017350	S.CER ECJ0EC1H020B	B	22.8/45.2
C230	4030017460	S.CER ECJ0EB1E102K	B	7.7/60.1
C232	4030017460	S.CER ECJ0EB1E102K	B	8.9/47.8
C233	4030017440	S.CER ECJ0EC1H221J	B	14.8/39.7
C234	4030018890	S.CER ECJ0EB0J224K	T	27.6/28.3
C235	4030018860	S.CER ECJ0EB0J105K	T	16.9/17.2
C236	4030017340	S.CER ECJ0EC1H010B	B	7.5/36.5
C237	4030017400	S.CER ECJ0EC1H220J	B	21.4/41.6
C238	4030016930	S.CER ECJ0EB1A104K	B	20.9/45.2
C239	4030017460	S.CER ECJ0EB1E102K	B	7.7/61
C240	4030017460	S.CER ECJ0EB1E102K	B	11/48.8
C241	4030017430	S.CER ECJ0EC1HJ	B	21.6/49.1
C242	4030017420	S.CER ECJ0EC1H470J	B	20.4/48.6
C243	4030017460	S.CER ECJ0EB1E102K	B	11.5/39
C244	4030017460	S.CER ECJ0EB1E102K	B	8.7/37.1
C245	4030017530	S.CER ECJ0EC1H0R5B	B	19.8/43.3
C246	4030017450	S.CER ECJ0EB1E271K	T	18.5/18.3
C247	4030017430	S.CER ECJ0EC1HJ	B	20.3/49.5
C248	4030016950	S.CER ECJ0EB1A473K	T	18.4/25.4
C249	4030016930	S.CER ECJ0EB1A104K	B	20.2/51.9
C250	4030017460	S.CER ECJ0EB1E102K	B	13.9/38.1
C251	4030017460	S.CER ECJ0EB1E102K	B	6.1/36.7
C252	4030017400	S.CER ECJ0EC1H220J	B	18.2/40.8
C253	4030017460	S.CER ECJ0EB1E102K	T	14.4/26
C254	4030016790	S.CER ECJ0EB1C103K	T	24.5/26.9
C255	4030017460	S.CER ECJ0EB1E102K	B	4.5/56.2
C256	4030016930	S.CER ECJ0EB1A104K	B	16.7/49.5
C257	4030017570	S.CER ECJ0EC1H040B	B	2.6/60.6
C258	4030017390	S.CER ECJ0EC1H180J	B	8.9/39.9
C259	4030017630	S.CER ECJ0EC1H120J	B	4.9/39.2
C260	4030017460	S.CER ECJ0EB1E102K	T	19.3/22.3
C261	4030017360	S.CER ECJ0EC1H030B	B	16.9/43.4
C262	4030016790	S.CER ECJ0EB1C103K	B	2.6/59.2
C263	4030017460	S.CER ECJ0EB1E102K	B	13.7/43.4
C264	4550003250	S.TAN TEESVA 1V 474M8R	B	38.9/50.4
C266	4030017460	S.CER ECJ0EB1E102K	B	13.6/55.3
C267	4030016930	S.CER ECJ0EB1A104K	B	19.6/54.1
C268	4030017780	S.CER ECJ0EB1E472K	B	15.8/24.7
C269	4030017660	S.CER ECJ0EC1H330J	B	13.6/56.9
C270	4030016790	S.CER ECJ0EB1C103K	B	21.9/56.9
C271	4030017460	S.CER ECJ0EB1E102K	B	9.1/42.6
C272	4030017460	S.CER ECJ0EB1E102K	B	4.9/41.9
C273	4030017460	S.CER ECJ0EB1E102K	B	39.1/60
C274	4030017460	S.CER ECJ0EB1E102K	B	39.5/55.3
C275	4030017630	S.CER ECJ0EC1H120J	B	4.6/61.5
C276	4030017660	S.CER ECJ0EC1H330J	B	13.5/59.1
C277	4030017460	S.CER ECJ0EB1E102K	B	8.9/40.8
C278	4030017460	S.CER ECJ0EB1E102K	B	4.9/40.1
C279	4030017460	S.CER ECJ0EB1E102K	B	14.4/44.9
C280	4030018860	S.CER ECJ0EB0J105K	T	31.8/20.6
C281	4030016930	S.CER ECJ0EB1A104K	B	21/56.9
C282	4030017600	S.CER ECJ0EC1H080C	B	4.6/62.4
C283	4030017400	S.CER ECJ0EC1H220J	B	12.6/60
C284	4030017420	S.CER ECJ0EC1H470J	B	21/58.1
C285	4030018890	S.CER ECJ0EB0J224K	B	39.1/58.1
C286	4030016930	S.CER ECJ0EB1A104K	T	

[MAIN UNIT]

REF NO.	ORDER NO.	DESCRIPTION	M.	H/V LOCATION
C288	4030017460	S.CER ECJ0EB1E102K	B	15.5/46.7
C289	4030017420	S.CER ECJ0EC1H470J	B	2.9/62.9
C290	4030017510	S.CER ECJ0EC1H680J	B	20/59.2
C291	4550007080	S.TAN TEESVA 1C 106M8R	B	37/61.4
C292	4030017460	S.CER ECJ0EB1E102K	B	39.1/59.1
C293	4030017400	S.CER ECJ0EC1H220J	B	12.6/63.2
C294	4030017620	S.CER ECJ0EC1H100C	B	18.8/59.5
C295	4030016790	S.CER ECJ0EB1C103K	B	11.3/45.2
C297	4030018910	S.CER C1608 JB 0J 475K-T	T	26.3/23.4
C300	4030017460	S.CER ECJ0EB1E102K	B	37.5/63.1
C301	4030017460	S.CER ECJ0EB1E102K	T	40.3/54.2
C302	4030017640	S.CER ECJ0EC1H150J	B	8.6/66
C303	4030016790	S.CER ECJ0EB1C103K	B	12.2/46
C304	4030017460	S.CER ECJ0EB1E102K	B	7.1/46.6
C305	4030017360	S.CER ECJ0EC1H030B	B	14.7/51.1
C306	4030017640	S.CER ECJ0EC1H150J	B	7.6/67.3
C307	4030017620	S.CER ECJ0EC1H100C	B	9.5/64.8
C308	4030017460	S.CER ECJ0EB1E102K	B	22.9/55.7
C309	4030017460	S.CER ECJ0EB1E102K	B	6.2/46.6
C310	4030017640	S.CER ECJ0EC1H150J	B	9.2/67.2
C311	4030017350	S.CER ECJ0EC1H020B	T	10.3/71
C312	4030017460	S.CER ECJ0EB1E102K	B	14.9/33
C313	4030017350	S.CER ECJ0EC1H020B	T	8.9/71.9
C314	4030017590	S.CER ECJ0EC1H070C	B	12.6/68.5
C315	4030017460	S.CER ECJ0EB1E102K	T	38.1/57
C470	4030017460	S.CER ECJ0EB1E102K	T	11.9/57.4
C478	4030016790	S.CER ECJ0EB1C103K	T	8.2/60.7
C479	4030017630	S.CER ECJ0EC1H120J	T	17.7/47.1
C480	4030017630	S.CER ECJ0EC1H120J	T	18.8/45.4
C481	4030017730	S.CER ECJ0EB1E471K	B	29.6/25.3
C482	4030017460	S.CER ECJ0EB1E102K	B	29.6/26.2
C485	4030009000	S.CER C2012 JB 1C 224K-T	T	15.4/8.7
C486	4030017460	S.CER ECJ0EB1E102K	T	18.5/2.3
C488	4550000530	S.TAN TEESVA 1V 104M8R	B	17.1/5.1
C493	4030017460	S.CER ECJ0EB1E102K	B	5/10.2
C500	4340000440	S.MLR ECPU1C684MA5	B	9.8/10.6
C501	4340000450	S.MLR ECPU1C105MA5	B	13.4/9.6
C503	4030017460	S.CER ECJ0EB1E102K	T	34.5/63.8
C504	4030017460	S.CER ECJ0EB1E102K	T	19.7/45.7
C505	4030017460	S.CER ECJ0EB1E102K	B	33.9/43.7
C506	4030017710	S.CER ECJ0EC1H181J	B	28.6/22.2
C507	4030016790	S.CER ECJ0EB1C103K	B	29.8/22.1
C508	4030016790	S.CER ECJ0EB1C103K	B	29.9/20.9
C509	4030017380	S.CER ECJ0EC1H050B	B	13.1/50.9
C510	4550007600	S.TAN F920J106MPABMA	T	19/30.5
C511	4030017500	S.CER ECJ0EC1H560J	B	21.4/27.2
C512	4030017500	S.CER ECJ0EC1H560J	B	19.2/28.8
C513	4030017430	S.CER ECJ0EC1HJ	B	22.6/26.4
C514	4030017570	S.CER ECJ0EC1H040B	B	14.4/58.3
C515	4030017340	S.CER ECJ0EC1H010B	B	5.9/62
C516	4030017340	S.CER ECJ0EC1H010B	B	13.5/60.7
C517	4030017900	S.CER ECJ0EB1C123K	B	32.5/56.5
C518	4030016930	S.CER ECJ0EB1A104K	T	39/53.9
C519	4030017400	S.CER ECJ0EC1H220J	B	9.5/58.4
C520	4030017460	S.CER ECJ0EB1E102K	B	12.6/35.5
C521	4030017400	S.CER ECJ0EC1H220J	B	7.4/35.3
C522	4030017610	S.CER ECJ0EC1H090C	B	6.6/45.4
C523	4030017400	S.CER ECJ0EC1H220J	B	4.7/42.9
C524	4030018860	S.CER ECJ0EB0J105K	T	2/42.8
C525	4030017460	S.CER ECJ0EB1E102K	B	7/2.3
C526	4030017730	S.CER ECJ0EB1E471K	B	2.6/34.3
C527	4030017460	S.CER ECJ0EB1E102K	B	23.3/53.9
C528	4030017440	S.CER ECJ0EC1H221J	B	22.4/53.9
C529	4030017420	S.CER ECJ0EC1H470J	B	21.5/53.9
C530	4030017460	S.CER ECJ0EB1E102K	B	20.3/52.8
C531	4030017460	S.CER ECJ0EB1E102K	T	26.4/18.9
C532	4030017440	S.CER ECJ0EC1H221J	T	25/1.8
C533	4030017440	S.CER ECJ0EC1H221J	T	23.8/2.3
C534	4030017440	S.CER ECJ0EC1H221J	T	26.2/2
C535	4030017460	S.CER ECJ0EB1E102K	T	21.7/2.4
C536	4030017730	S.CER ECJ0EB1E471K	B	19.4/20.8
C537	4030017730	S.CER ECJ0EB1E471K	B	17.8/20.8
C538	4030017460	S.CER ECJ0EB1E102K	T	3.6/62.1
C539	4030017460	S.CER ECJ0EB1E102K	T	3.6/60.3
C540	4030017460	S.CER ECJ0EB1E102K	T	3.6/58.5
C541	4030017460	S.CER ECJ0EB1E102K	T	3.6/56.7
C542	4030017440	S.CER ECJ0EC1H221J	T	4.3/50.9
C543	4030017440	S.CER ECJ0EC1H221J	T	4.3/50
C545	4030017460	S.CER ECJ0EB1E102K	T	26/34.6
C546	4030017460	S.CER ECJ0EB1E102K	T	18.2/61
C547	4030017430	S.CER ECJ0EC1HJ	T	16.5/60.6
C548	4030017460	S.CER ECJ0EB1E102K	T	21.4/68.9
C549	4030017460	S.CER ECJ0EB1E102K	T	5.2/60.2
C550	4030017610	S.CER ECJ0EC1H090C	B	4.4/54.6
C551	4030017430	S.CER ECJ0EC1HJ	B	11.1/25
C552	4550006970	S.TAN TEESVA0G476M8R	B	35.3/55.3
C553	4550006970	S.TAN TEESVA0G476M8R	B	34.6/49.1
J4	6450001910	CNR HSJ1594-050	T	
J5	6510021900	S.C.NR BM02B-ASRS-TF	T	25.1/31.3
J6	6510024970	S.C.NR AXK5F16535YJ	B	18.1/16.9
DS1	5030002860	LCD A01B004X 2869LCD	T	
DS2	5040002930	S.LED SML-512MW T86	T	39.2/33.6
DS3	5040002930	S.LED SML-512MW T86	T	10.5/35.1

[MAIN UNIT]

REF NO.	ORDER NO.	DESCRIPTION	M.	H/V LOCATION
DS4	5040002930	S.LED SML-512MW T86	T	6.7/23.2
DS5	5040002930	S.LED SML-512MW T86	T	7/12
DS8	5040003160	S.LED BRPY1211C-TR	T	26.7/72.7
MC1	7700002310	MIC EM-140		
S8	7600000210	ECR TP70N00E20-15F-1903		
EP2	89300068460	LCT SRCN-2869-S-N-C		
EP3	6910015370	S.BEA ACZ1005Y-102-T	B	15.2/13.8
EP4	6910015370	S.BEA ACZ1005Y-102-T	B	32.6/15.3
EP5	6910012350	S.BEA MMZ1608Y 102BT	T	14.4/55.7
EP6	6910012350	S.BEA MMZ1608Y 102BT	T	20.3/44.3
EP7	6910015370	S.BEA ACZ1005Y-102-T	B	18.7/22
EP8	6910015370	S.BEA ACZ1005Y-102-T	B	17.8/22
EP9	6910015370	S.BEA ACZ1005Y-102-T	B	21.2/20.7

[VCO BOARD]

REF NO.	ORDER NO.	DESCRIPTION	M.	H/V LOCATION
Q1	1590001650	S.TR XP4601 (TX)	T	8.8/2.5
Q2	1530003321	S.TR 2SC5108 Y	T	22.1/17.2
Q3	1590002010	S.TR XP1114 (TX)	T	13.2/3.4
Q4	1590003240	S.TR UNR9114J-(TX)	T	15.6/2.3
Q5	1590003270	S.TR UNR9210J-(TX)	T	5.6/17.4
Q8	1530003260	S.TR 2SC5006-T1	T	13.8/15.8
Q9	1530003260	S.TR 2SC5006-T1	T	11.3/9.9
Q10	1530003260	S.TR 2SC5006-T1	T	7.7/5.6
Q11	1530003260	S.TR 2SC5006-T1	T	16.4/17.2
Q12	1530003260	S.TR 2SC5006-T1	T	13.6/11.3
Q13	1530003260	S.TR 2SC5006-T1	T	9.7/8
Q14	1530003321	S.TR 2SC5108 Y	T	17.9/11.9
Q15	1590003270	S.TR UNR9210J-(TX)	T	14.7/6.2
Q16	1590003270	S.TR UNR9210J-(TX)	T	18.7/1.3
Q17	1590002380	S.TR XP1115 (TX)	T	23/1.6
Q18	1530003760	S.TR 2SC5508-T2	T	20.6/8.8
Q19	1530003321	S.TR 2SC5108 Y	T	21.9/14.3
D1	1750000940	S.DIO ISS400 TE61	T	6.8/2.4
D2	1790001260	S.DIO MA2S077-(TX)	T	8.8/17
D3	1790001260	S.DIO MA2S077-(TX)	T	4.5/11.8
D4	1790001260	S.DIO MA2S077-(TX)	T	3.1/6.1
D5	1720000650	S.VCP 1SV286 (TPH3)	T	12.2/18.4
D6	1720000650	S.VCP 1SV286 (TPH3)	T	9.4/13.3
D7	1720000840	S.VCP HVD328CKRU-E	T	5.1/5.6
D8	1720000840	S.VCP HVD328CKRU-E	T	6.1/5.6
D9	1790001621	S.DIO 1SV308	T	18.9/19.1
D10	1790001621	S.DIO 1SV308	T	14.5/14.2
D11	1790001621	S.DIO 1SV308	T	12.1/8.3
D12	1790001621	S.DIO 1SV308	T	23.1/11.5
D13	1790001621	S.DIO 1SV308	T	24.3/9.7
D14	1790001260	S.DIO MA2S077-(TX)	T	16.4/6.7
D15	1790001260	S.DIO MA2S077-(TX)	T	17.2/5
D16	1790001621	S.DIO 1SV308	T	22.4/5.6
D17	1790001621	S.DIO 1SV308	T	24.3/6.4
D18	1750000940	S.DIO ISS400 TE61	T	5.6/2.4
L1	6200010630	S.COL LQW18AN8N2D00D	T	7.9/19.1
L2	6200010910	S.COL LQW18AN56NG00D	T	5.2/15.2
L3	6200011660	S.COL LQW18ANR15G00D	T	3.1/10.2
L4	6200010630	S.COL LQW18AN8N2D00D	T	10.5/19.1
L5	6200009290	S.COL LQW18AN47NG00D	T	7.4/14
L6	6200011650	S.COL LQW18AN68NG00D	T	4.8/8.2
L7	6200005711	S.COL ELJRE 27NGFA	T	20.6/6.9
L8	6200005671	S.COL ELJRE 12NGFA	T	17.7/6.8
L9	6200005671	S.COL ELJRE 12NGFA	T	20.6/5
R1	7030005720	S.RES ERJ2GEJ 563 X (56 kΩ)	T	4.4/2
R2	7030007300	S.RES ERJ2GEJ 332 X (3.3 kΩ)	T	7.4/4.1
R3	7030004990	S.RES ERJ2GEJ 221 X (220 Ω)	T	24/17.1
R4	7030005060	S.RES ERJ2GEJ 333 X (33 kΩ)	T	22.1/18.6
R7	7030005240	S.RES ERJ2GEJ 473 X (47 kΩ)	T	3.3/4
R8	7030009140	S.RES ERJ2GEJ 272 X (2.7 kΩ)	T	9/15.9
R9	7030009140	S.RES ERJ2GEJ 272 X (2.7 kΩ)	T	5.6/11.5
R10	7030009140	S.RES ERJ2GEJ 272 X (2.7 kΩ)	T	4.1/5.2
R11	7030005040	S.RES ERJ2GEJ 472 X (4.7 kΩ)	T	10/18
R12	7030005040	S.RES ERJ2GEJ 472 X (4.7 kΩ)	T	6.5/12.6
R13	7030005040	S.RES ERJ2GEJ 472 X (4.7 kΩ)	T	4.1/6.8
R14	7030005700	S.RES ERJ2GEJ 274 X (270 kΩ)	T	10.5/16.1
R15	7030005090	S.RES ERJ2GEJ 104 X (100 kΩ)	T	8.3/11
R16	7030007290	S.RES ERJ2GEJ 222 X (2.2 kΩ)	T	11.4/16.1
R17	7030009140	S.RES ERJ2GEJ 272 X (2.7 kΩ)	T	7.4/12.6

M.=Mounted side (T: Mounted on the Top side, B: Mounted on the Bottom side)  
S.=Surface mount

[VCO BOARD]

REF NO.	ORDER NO.	DESCRIPTION	M.	H/V LOCATION
R18	7030007300	S.RES ERJ2GEJ 332 X (3.3 kΩ)	T	13.7/17.3
R19	7030009290	S.RES ERJ2GEJ 562 X (5.6 kΩ)	T	10/11.3
R20	7030009290	S.RES ERJ2GEJ 562 X (5.6 kΩ)	T	7.5/7
R21	7030004980	S.RES ERJ2GEJ X (100 Ω)	T	14.9/17.1
R22	7030007270	S.RES ERJ2GEJ 151 X (150 Ω)	T	11.6/11.3
R23	7030004980	S.RES ERJ2GEJ X (100 Ω)	T	7.7/7.9
R24	7030007300	S.RES ERJ2GEJ 332 X (3.3 kΩ)	T	16.1/18.6
R25	7030009290	S.RES ERJ2GEJ 562 X (5.6 kΩ)	T	13.2/12.8
R26	7030009290	S.RES ERJ2GEJ 562 X (5.6 kΩ)	T	9.3/9.4
R27	7030004980	S.RES ERJ2GEJ X (100 Ω)	T	18/17.4
R28	7030007270	S.RES ERJ2GEJ 151 X (150 Ω)	T	14.6/10.1
R29	7030004980	S.RES ERJ2GEJ X (100 Ω)	T	10.1/6.2
R30	7030005040	S.RES ERJ2GEJ 472 X (4.7 kΩ)	T	18.9/17.8
R31	7030005040	S.RES ERJ2GEJ 472 X (4.7 kΩ)	T	15.5/12.8
R32	7030005040	S.RES ERJ2GEJ 472 X (4.7 kΩ)	T	11.5/6.3
R33	7030005040	S.RES ERJ2GEJ 472 X (4.7 kΩ)	T	16.2/14.5
R34	7030005040	S.RES ERJ2GEJ 472 X (4.7 kΩ)	T	24/12.5
R35	7030005220	S.RES ERJ2GEJ 223 X (22 kΩ)	T	18.3/13.3
R36	7030004980	S.RES ERJ2GEJ X (100 Ω)	T	19.2/10.6
R37	7030005040	S.RES ERJ2GEJ 472 X (4.7 kΩ)	T	22.3/12.5
R38	7030007280	S.RES ERJ2GEJ 331 X (330 Ω)	T	21/11.5
R39	7030005300	S.RES ERJ2GEJ 150 X (15 Ω)	T	19.9/13.3
R40	7030005300	S.RES ERJ2GEJ 150 X (15 Ω)	T	19.5/14.5
R41	7030005300	S.RES ERJ2GEJ 150 X (15 Ω)	T	20.4/14.5
R42	7030007350	S.RES ERJ2GEJ 393 X (39 kΩ)	T	22.3/10.2
R43	7030004980	S.RES ERJ2GEJ X (100 Ω)	T	22.3/7
R44	7030007290	S.RES ERJ2GEJ 222 X (2.2 kΩ)	T	23.8/8.1
R45	7030005220	S.RES ERJ2GEJ 223 X (22 kΩ)	T	22.4/15.7
R46	7030005050	S.RES ERJ2GEJ 103 X (10 kΩ)	T	17/8.9
R47	7030007270	S.RES ERJ2GEJ 151 X (150 Ω)	T	24/15.3
R48	7030005050	S.RES ERJ2GEJ 103 X (10 kΩ)	T	20.5/3.2
R49	7030005040	S.RES ERJ2GEJ 472 X (4.7 kΩ)	T	21.6/4.2
R50	7030005040	S.RES ERJ2GEJ 472 X (4.7 kΩ)	T	23.4/4.3
R51	7030004980	S.RES ERJ2GEJ X (100 Ω)	T	5/5.6
C1	4030017460	S.CER ECJ0EB1E102K	T	10.3/4.1
C2	4030016930	S.CER ECJ0EB1A104K	T	3.1/1.5
C3	4030016930	S.CER ECJ0EB1A104K	T	9.3/6.9
C4	4030018890	S.CER ECJ0EBOJ224K	T	5.8/4
C5	4030016930	S.CER ECJ0EB1A104K	T	7.3/6.9
C6	4550007600	S.TAN F920J106MPABMA	T	11/2
C9	4030017460	S.CER ECJ0EB1E102K	T	12.4/1.1
C10	4030017460	S.CER ECJ0EB1E102K	T	14.2/1.1
C11	4030017460	S.CER ECJ0EB1E102K	T	23.3/18.4
C12	4030017460	S.CER ECJ0EB1E102K	T	24/16.2
C13	4030017460	S.CER ECJ0EB1E102K	T	15.6/6
C15	4030017460	S.CER ECJ0EB1E102K	T	13.3/1.1
C16	4030017340	S.CER ECJ0EC1H010B	T	20.4/17.2
C17	4030017460	S.CER ECJ0EB1E102K	T	15.1/4.8
C18	4030017460	S.CER ECJ0EB1E102K	T	15.2/3.9
C19	4030017460	S.CER ECJ0EB1E102K	T	12/5.4
C20	4030017460	S.CER ECJ0EB1E102K	T	4/17.6
C23	4030017460	S.CER ECJ0EB1E102K	T	2.9/18.5
C24	4030017460	S.CER ECJ0EB1E102K	T	2.9/16.9
C25	4030017460	S.CER ECJ0EB1E102K	T	4.4/13.5
C32	4030016790	S.CER ECJ0EB1C103K	T	7.4/15
C33	4030016790	S.CER ECJ0EB1C103K	T	5.3/9.3
C34	4030016790	S.CER ECJ0EB1C103K	T	3.3/3.1
C35	4030016790	S.CER ECJ0EB1C103K	T	7.2/17.6
C36	4030016790	S.CER ECJ0EB1C103K	T	6.2/15.5
C37	4030016790	S.CER ECJ0EB1C103K	T	4.1/9.8
C38	4030016790	S.CER ECJ0EB1C103K	T	8.4/18
C39	4030017460	S.CER ECJ0EB1E102K	T	9/15
C40	4030016790	S.CER ECJ0EB1C103K	T	5.6/13.1
C41	4030016790	S.CER ECJ0EB1C103K	T	6.5/11
C42	4030016790	S.CER ECJ0EB1C103K	T	3.1/8.1
C43	4030016790	S.CER ECJ0EB1C103K	T	4.6/3.6
C45	4030017460	S.CER ECJ0EB1E102K	T	10.8/14.9
C47	4030017460	S.CER ECJ0EB1E102K	T	7.4/11
C49	4030017460	S.CER ECJ0EB1E102K	T	12.3/16.1
C50	4030017460	S.CER ECJ0EB1E102K	T	8.3/12.6
C51	4030017550	S.CER ECJ0EC1H1R5B	T	14.5/19.2
C52	4030017550	S.CER ECJ0EC1H1R5B	T	13.3/18.6
C53	4030017550	S.CER ECJ0EC1H1R5B	T	11.6/13.1
C54	4030017350	S.CER ECJ0EC1H020B	T	10.4/12.7
C55	4030017590	S.CER ECJ0EC1H070C	T	7.7/9.7
C56	4030017590	S.CER ECJ0EC1H070C	T	5.4/7.1
C57	4030017460	S.CER ECJ0EB1E102K	T	17.4/15.7
C58	4030017460	S.CER ECJ0EB1E102K	T	13.7/9.6
C59	4030017460	S.CER ECJ0EB1E102K	T	9.7/5
C60	4030017460	S.CER ECJ0EB1E102K	T	14.5/18.3
C61	4030017460	S.CER ECJ0EB1E102K	T	11.6/12.2
C62	4030016790	S.CER ECJ0EB1C103K	T	7.7/8.8
C63	4030017460	S.CER ECJ0EB1E102K	T	15.8/15.7
C64	4030017460	S.CER ECJ0EB1E102K	T	12.8/9.6
C65	4030016790	S.CER ECJ0EB1C103K	T	9.2/6.2
C66	4030017530	S.CER ECJ0EC1H0R5B	T	17.3/18.8
C67	4030017340	S.CER ECJ0EC1H010B	T	14.6/12.8
C68	4030017340	S.CER ECJ0EC1H010B	T	11.5/7.2
C70	4030017460	S.CER ECJ0EB1E102K	T	15.6/11.6
C72	4030017460	S.CER ECJ0EB1E102K	T	17.6/10.4
C73	4030017620	S.CER ECJ0EC1H100C	T	16.7/13.3
C74	4030017460	S.CER ECJ0EB1E102K	T	21.1/1.1
C75	4030017460	S.CER ECJ0EB1E102K	T	17.1/1.5
C76	4030017460	S.CER ECJ0EB1E102K	T	19.5/12

[VCO BOARD]

REF NO.	ORDER NO.	DESCRIPTION	M.	H/V LOCATION
C77	4030017460	S.CER ECJ0EB1E102K	T	22.3/8.6
C78	4030017460	S.CER ECJ0EB1E102K	T	17.2/4
C79	4030017460	S.CER ECJ0EB1E102K	T	20.2/1.1
C80	4030017610	S.CER ECJ0EC1H090C	T	21/10.6
C81	4030017460	S.CER ECJ0EB1E102K	T	23.3/13.4
C82	4030017380	S.CER ECJ0EC1H050B	T	20.8/15.7
C83	4030017350	S.CER ECJ0EC1H020B	T	18.8/7.1
C84	4030017460	S.CER ECJ0EB1E102K	T	23.2/9.3
C85	4030017400	S.CER ECJ0EC1H220J	T	17.9/8.9
C86	4030017620	S.CER ECJ0EC1H100C	T	18.8/8.9
C87	4030017350	S.CER ECJ0EC1H020B	T	19.2/5.8
C88	4030017460	S.CER ECJ0EB1E102K	T	16.1/8.9
C89	4030017460	S.CER ECJ0EB1E102K	T	24/14.4
C90	4030017460	S.CER ECJ0EB1E102K	T	20.7/12.4
C91	4030017460	S.CER ECJ0EB1E102K	T	23.2/6.9
C92	4030017460	S.CER ECJ0EB1E102K	T	22.5/4.2
C93	4030017620	S.CER ECJ0EC1H100C	T	19.2/4.9
C94	4030017380	S.CER ECJ0EC1H050B	T	19.2/4
C95	4030017460	S.CER ECJ0EB1E102K	T	24.3/4.3
J1	6510024980	S.CNR AXK6F16335YJ	B	13.2/11.2
EP1	6910012350	S.BEA MMZ1608Y 102BT	T	5.3/19.1
EP2	6910012350	S.BEA MMZ1608Y 102BT	T	4/15.4
EP3	6910012350	S.BEA MMZ1608Y 102BT	T	3.1/12.8

[PA BOARD]

REF NO.	ORDER NO.	DESCRIPTION	M.	H/V LOCATION
Q1	1530003260	S.TR 2SC5006-T1	B	5.9/5.9
Q2	1530003920	S.TR 2SC5998YC-TL-E	B	6.1/12
Q3	1560001430	S.FET RQA0003TL-E	T	6.2/22.8
D1	1750000861	S.DIO HVC132TRF-E	B	4.1/3.7
D2	1790001200	S.DIO MA6S121 (TX)	B	2.8/10.9
L2	6200005721	S.COL ELJRE 33NGFA	B	5.6/7.7
L6	6200008400	S.COL 0.35-1.6-6TL 36N	B	5.9/15.1
L7	6200005601	S.COL ELJRE 3N3ZFA	T	7.2/16.2
L8	6200008260	S.COL 0.30-1.7-8TL 60N	B	5.8/27.6
L9	6200005590	S.COL ELJRE 2N7Z-F	T	
L10	6200005661	S.COL ELJRE 10NGFA	B	6.4/9.8
L11	6200007871	S.COL ELJRF 39NJFB	T	6.7/4.6
R1	7030005120	S.RES ERJ2GEJ 102 X (1 kΩ)	T	
R2	7030005290	S.RES ERJ2GEJ 682 X (6.8 kΩ)	T	7.3/7.3
R3	7030005530	S.RES ERJ2GEJ 100 X (10 Ω)	T	
R4	7030005120	S.RES ERJ2GEJ 102 X (1 kΩ)	T	4.4/4
R8	7030005120	S.RES ERJ2GEJ 102 X (1 kΩ)	B	2.3/8.7
R9	7030005530	S.RES ERJ2GEJ 100 X (10 Ω)	T	
R10	7030005090	S.RES ERJ2GEJ 104 X (100 kΩ)	T	9.3/22.7
R11	7030007250	S.RES ERJ2GEJ 220 X (22 Ω)	T	8.4/20.7
R12	7030005010	S.RES ERJ2GEJ 681 X (680 Ω)	B	5.7/3.9
R13	7030005310	S.RES ERJ2GEJ 124 X (120 kΩ)	T	8.4/22.3
R14	7030004970	S.RES ERJ2GEJ 470 X (47 Ω)	B	2.8/5
R15	7030007570	S.RES ERJ2GEJ 122 X (1.2 kΩ)	B	3.5/9.1
R16	7030005430	S.RES ERJ3GEYJ 3R3 V (3.3 Ω)	T	7.3/19.6
R17	7030005530	S.RES ERJ2GEJ 100 X (10 Ω)	B	4.7/9.7
R18	7030007260	S.RES ERJ2GEJ 330 X (33 Ω)	B	11.9/28.9
C1	4030017460	S.CER ECJ0EB1E102K	B	7.3/3.8
C3	4030017460	S.CER ECJ0EB1E102K	B	7.3/5.4
C4	4030017460	S.CER ECJ0EB1E102K	B	4/6.4
C6	4030017660	S.CER ECJ0EC1H330J	B	7.3/8.4
C7	4030017460	S.CER ECJ0EB1E102K	T	4/5.2
C11	4030017460	S.CER ECJ0EB1E102K	B	2.3/7.1
C13	4030016790	S.CER ECJ0EB1C103K	T	2.5/15.2
C14	4030017460	S.CER ECJ0EB1E102K	B	2.6/15.1
C16	4030017390	S.CER ECJ0EC1H180J	B	3.7/13
C17	4550007650	S.TAN F931V105MAABMA	B	4.7/30.7
C18	4030017460	S.CER ECJ0EB1E102K	T	9.8/23.9
C19	4030017460	S.CER ECJ0EB1E102K	T	9.3/21.1
C20	4030017460	S.CER ECJ0EB1E102K	B	3.6/29
C21	4030017660	S.CER ECJ0EC1H330J	T	7.2/17.9
C22	4030017460	S.CER ECJ0EB1E102K	T	8.4/18.7
C23	4030017400	S.CER ECJ0EC1H220J	B	3.6/26.3
C24	4030017460	S.CER ECJ0EB1E102K	T	7.3/8.2
C25	4030017460	S.CER ECJ0EB1E102K	B	4/5.2
C26	4030017390	S.CER ECJ0EC1H180J	B	5.8/8.7
C27	4030018910	S.CER C1608 JB 0J 475K-T	T	6/7.3
C28	4030017440	S.CER ECJ0EC1H221J	B	11.9/16.5
DS1	5040002930	S.LED SML-512MW T86	B	11.7/26.8

M.=Mounted side (T: Mounted on the Top side, B: Mounted on the Bottom side)  
S.=Surface mount



[PA BOARD]

REF NO.	ORDER NO.	DESCRIPTION	M.	H/V LOCATION
S1	2260002060	S.SW SKQGAD	T	6/11.9
S2	2260002060	S.SW SKQGAD	T	6/27.5
EP1	6910012350	S.BEA MMZ1608Y 102BT	T	4.7/15.7
EP2	6910015370	S.BEA ACZ1005Y-102-T	B	3.9/7.6
EP3	6910015370	S.BEA ACZ1005Y-102-T	T	10.3/31.6
EP4	6910015370	S.BEA ACZ1005Y-102-T	B	11.9/30.5
EP5	6910015370	S.BEA ACZ1005Y-102-T	T	11.9/28.9
EP6	6910015370	S.BEA ACZ1005Y-102-T	T	10.2/26.6
EP7	6910014690	S.BEA MPZ1608S221A-T	B	11.8/22.5
EP8	6910015370	S.BEA ACZ1005Y-102-T	B	11.9/19.9
EP9	6910015370	S.BEA ACZ1005Y-102-T	B	11.9/18.1

[CHASSIS PARTS]

REF NO.	ORDER NO.	DESCRIPTION	M.	H/V LOCATION
J1	6510025010	CNR SMA-R2869		
SP1	2510000840	SP CS028014-12		
W1	8900010960	CBL OPC-1129		

• BC-164

[MAIN UNIT]

REF NO.	ORDER NO.	DESCRIPTION	M.	H/V LOCATION
IC1	1110006480	S.IC NJM2801U1-0543-TE1	B	22.4/66.7
IC2	1110003070	S.IC μPC494GS-E1	B	19.2/30.9
IC3	1140012300	S.IC μPD789112AMC-534-5A4	B	31.5/30
IC4	1110002700	S.IC NJM2904M-TE1-#ZZZB	B	37/70.2
Q1	1530002060	S.TR 2SC4081 T106 R	B	13.4/68.5
Q2	1550000090	S.FET RSQ035P03TR	B	15.2/63.3
Q3	1530002060	S.TR 2SC4081 T106 R	B	31.4/56.5
Q4	1530002060	S.TR 2SC4081 T106 R	B	26.1/58.3
Q5	1590000430	S.TR DTC144EUA T106	B	27/37.9
Q6	1530002060	S.TR 2SC4081 T106 R	B	13.4/71.5
Q7	1510000510	S.TR 2SA1576A T106R	B	26.8/46.2
Q8	1510000510	S.TR 2SA1576A T106R	B	30.9/47.2
Q9	1590000430	S.TR DTC144EUA T106	B	31/41.6
D1	1730002350	S.ZEN MA8110-M (TX)	B	12.3/74.7
D2	1750000550	S.DIO 1SS355 TE-17	B	14.9/65.9
D3	1750001110	S.DIO SM240A-T	B	12.7/60
D4	1160000070	S.DIO DAN202K T146	B	36.9/45.1
D5	1750000550	S.DIO 1SS355 TE-17	B	40.3/39.1
D6	1750001110	S.DIO SM240A-T	B	9.2/20.8
X1	6060000790	S.CER CSTCR4M91G	B	32.2/21.3
L1	6190001640	S.COL SLF12555T-101M1R1	B	6.5/48.9
L2	6200002610	S.COL NL 252018T-R47J	B	24.5/37.8
R2	7030000460	S.RES MCR10EZHZ 4.7 kΩ	B	11.3/72.3
R3	7030003410	S.RES ERJ3GEYJ 561 V (560 Ω)	B	15.3/70.1
R4	7030003200	S.RES ERJ3GEYJ 100 V (10 Ω)	B	12.7/65.5
R5	7030009580	S.RES ERJ8RSJ R12V	B	20.6/16.1
R6	7030000540	S.RES MCR10EZHZ 22 kΩ	B	34/52.3
R7	7030003440	S.RES ERJ3GEYJ 102 V (1 kΩ)	B	29.7/58.3
R8	7030003520	S.RES ERJ3GEYJ 472 V (4.7 kΩ)	B	26.2/60.2
R9	7030003600	S.RES ERJ3GEYJ 223 V (22 kΩ)	B	21.8/38.9
R10	7030003800	S.RES ERJ3GEYJ 105 V (1 MΩ)	B	16.6/43.3
R11	7030003600	S.RES ERJ3GEYJ 223 V (22 kΩ)	B	15.3/43.3
R12	7030003560	S.RES ERJ3GEYJ 103 V (10 kΩ)	B	21.8/36.4
R13	7030003600	S.RES ERJ3GEYJ 223 V (22 kΩ)	B	18.9/38.9
R14	7030003770	S.RES ERJ3GEYJ 564 V (560 kΩ)	B	18.9/40.6
R15	7030003650	S.RES ERJ3GEYJ 563 V (56 kΩ)	B	13.3/40.6
R16	7030003770	S.RES ERJ3GEYJ 564 V (560 kΩ)	B	13.3/38.9
R17	7030003560	S.RES ERJ3GEYJ 103 V (10 kΩ)	B	14/43.3
R18	7030003410	S.RES ERJ3GEYJ 561 V (560 Ω)	B	23.9/24
R19	7030003620	S.RES ERJ3GEYJ 333 V (33 kΩ)	B	16.4/25.1
R20	7030003620	S.RES ERJ3GEYJ 333 V (33 kΩ)	B	10.7/40.4

[MAIN UNIT]

REF NO.	ORDER NO.	DESCRIPTION	M.	H/V LOCATION
R21	7030003440	S.RES ERJ3GEYJ 102 V (1 kΩ)	B	24.5/40.9
R22	7030003500	S.RES ERJ3GEYJ 332 V (3.3 kΩ)	B	40.3/35.4
R23	7030003560	S.RES ERJ3GEYJ 103 V (10 kΩ)	B	41.1/37.3
R24	7030003320	S.RES ERJ3GEYJ 101 V (100 Ω)	B	40.3/32.8
R25	7030003320	S.RES ERJ3GEYJ 101 V (100 Ω)	B	41.8/35.4
R26	7030003560	S.RES ERJ3GEYJ 103 V (10 kΩ)	B	29.6/65.5
R27	7030007220	S.RES ERA3YED 202V	B	38.1/62.6
R28	7030011200	S.RES ERA3YEB 303V	B	38.1/63.8
R29	7030011190	S.RES ERA3YEB 103V	B	34.6/64.5
R30	7030005871	S.RES ERA3YKD 104V (100 kΩ)	B	33.5/73.3
R31	7030003560	S.RES ERJ3GEYJ 103 V (10 kΩ)	B	38.1/65.5
R32	7030005341	S.RES ERA3YED 332V	B	40.5/71.6
R33	7030000500	S.RES MCR10EZHZ 10 kΩ	B	40.9/63.1
R34	7030003800	S.RES ERJ3GEYJ 105 V (1 MΩ)	B	31.7/74.9
R35	7030003440	S.RES ERJ3GEYJ 102 V (1 kΩ)	B	38.4/74.9
R36	7030003520	S.RES ERJ3GEYJ 472 V (4.7 kΩ)	B	39.3/44.9
R37	7030003690	S.RES ERJ3GEYJ 124 V (120 kΩ)	B	38.2/42.6
R38	7030005671	S.RES ERA3YKD 393V (39 kΩ)	B	36.2/40.2
R39	7030011140	S.RES ERJ8GEYJ JPW	B	18.4/53.4
R40	7030011140	S.RES ERJ8GEYJ JPW	B	23/62.3
R41	7030003860	S.RES ERJ3GE JPW V	B	40.4/41.2
R43	7030003860	S.RES ERJ3GE JPW V	B	28.9/61.1
R50	7030008240	S.RES ERJ12YJ0R00U	B	22.7/51.5
R52	7030003860	S.RES ERJ3GE JPW V	B	18.4/43.3
R53	7030008240	S.RES ERJ12YJ0R00U	B	25.7/15
R61	7030000010	S.RES MCR10EZHZ JPW (000)	B	37.1/37.2
R65	7030000010	S.RES MCR10EZHZ JPW (000)	B	28.5/40.5
R66	7030003560	S.RES ERJ3GEYJ 103 V (10 kΩ)	B	29/20.7
R68	7030003800	S.RES ERJ3GEYJ 105 V (1 MΩ)	B	29/44.5
R69	7030003800	S.RES ERJ3GEYJ 105 V (1 MΩ)	B	31.5/44.5
R70	7030003640	S.RES ERJ3GEYJ 473 V (47 kΩ)	B	30.2/44.5
R71	7030003520	S.RES ERJ3GEYJ 472 V (4.7 kΩ)	B	24.7/46.3
R72	7030003560	S.RES ERJ3GEYJ 103 V (10 kΩ)	B	29/48.1
R73	7030011140	S.RES ERJ8GEYJ JPW	B	17/67.8
R74	7030008240	S.RES ERJ12YJ0R00U	B	8/29.6
R75	7030011140	S.RES ERJ8GEYJ JPW	B	18.1/61.5
R76	7030011140	S.RES ERJ8GEYJ JPW	B	14.1/53.4
R77	7030000010	S.RES MCR10EZHZ JPW (000)	B	19.3/59.8
R78	7030011140	S.RES ERJ8GEYJ JPW	B	16.3/53.4
R79	7030011140	S.RES ERJ8GEYJ JPW	B	30.5/69.3
R80	7030008240	S.RES ERJ12YJ0R00U	B	41.2/50.5
R81	7030011140	S.RES ERJ8GEYJ JPW	B	35.2/49.6
R82	7030011140	S.RES ERJ8GEYJ JPW	B	34.2/42.5
R83	7030008240	S.RES ERJ12YJ0R00U	B	35.3/59.8
R84	7030003860	S.RES ERJ3GE JPW V	B	35/47.5
R85	7030011140	S.RES ERJ8GEYJ JPW	B	13.2/36.9
R86	7030011140	S.RES ERJ8GEYJ JPW	B	28.7/50.9
R87	7030011140	S.RES ERJ8GEYJ JPW	B	38.4/54.3
R88	7030011140	S.RES ERJ8GEYJ JPW	B	35.3/56.7
R89	7030011140	S.RES ERJ8GEYJ JPW	B	22.3/57.7
R91	7030011140	S.RES ERJ8GEYJ JPW	B	32.9/69.4
R92	7030003860	S.RES ERJ3GE JPW V	B	31.7/73
R93	7030003860	S.RES ERJ3GE JPW V	B	29.1/73.8
R94	7030003860	S.RES ERJ3GE JPW V	B	28.6/63.1
R95	7030003860	S.RES ERJ3GE JPW V	B	26.7/19.1
R96	7030011140	S.RES ERJ8GEYJ JPW	B	36.9/17.9
R97	7030011140	S.RES ERJ8GEYJ JPW	B	31.4/64.2
R98	7030011140	S.RES ERJ8GEYJ JPW	B	42/58.5
R99	7030003860	S.RES ERJ3GE JPW V	B	31.5/60.4
R100	7030003860	S.RES ERJ3GE JPW V	B	29.7/59.5
R102	7510001670	S.TMR NTCG16 4BH 103KT	B	43.9/53.2
R104	7030011140	S.RES ERJ8GEYJ JPW	B	41.6/56.4
R105	7030003680	S.RES ERJ3GEYJ 104 V (100 kΩ)	B	11.8/18.9
C1	4030006900	S.CER C1608 JB 1H 103K-T	B	6.5/67.6
C2	4030006900	S.CER C1608 JB 1H 103K-T	B	1.4/70.4
C3	4030006860	S.CER C1608 JB 1H 102K-T	B	6.5/64.6
C4	4030006900	S.CER C1608 JB 1H 103K-T	B	23/18.9
C5	4030006900	S.CER C1608 JB 1H 103K-T	B	23/17.7
C6	4510004630	S.ELE ECEV1CA100SR	B	16.7/74.5
C7	4030011600	S.CER C1608 JB 1E 104K-T	B	27.7/70.3
C8	4030006900	S.CER C1608 JB 1H 103K-T	B	25.7/65.9
C9	4030011600	S.CER C1608 JB 1E 104K-T	B	18.1/71
C10	4510006230	S.ELE ECEV1EA470UP	B	6.4/74
C11	4030006900	S.CER C1608 JB 1H 103K-T	B	12.7/62.9
C12	4030006900	S.CER C1608 JB 1H 103K-T	B	3.9/33.8
C13	4510006230	S.ELE ECEV1EA470UP	B	4.5/38
C14	4550007320	S.TAN F930J226MAABMA	B	30.6/54.2
C15	4550007320	S.TAN F930J226MAABMA	B	27.1/54.5
C16	4030006860	S.CER C1608 JB 1H 102K-T	B	21.8/37.7
C17	4030011600	S.CER C1608 JB 1E 104K-T	B	16.1/38.9
C18	4030006900	S.CER C1608 JB 1H 103K-T	B	16.1/40.6
C19	4030006900	S.CER C1608 JB 1H 103K-T	B	19.1/25.1
C20	4030009980	S.CER C1608 JB 1H 152K-T	B	23.9/25.3
C21	4030011600	S.CER C1608 JB 1E 104K-T	B	29/23.4
C22	4030006900	S.CER C1608 JB 1H 103K-T	B	25.4/35.2
C23	4030006900	S.CER C1608 JB 1H 103K-T	B	33.3/65.5
C24	4030006900	S.CER C1608 JB 1H 103K-T	B	35.9/64.5
C25	4030004760	S.CER C2012 JF 1H 104Z-T	B	41.6/68.1
C26	4030006900	S.CER C1608 JB 1H 103K-T	B	41.2/69.7
C27	4030006900	S.CER C1608 JB 1H 103K-T	B	41.5/66.6
C28	4030006900	S.CER C1608 JB 1H 103K-T	B	37.5/40.2
C31	4030006900	S.CER C1608 JB 1H 103K-T	B	27.7/43.5
J1	6510024940	CNR HEC2305-016250		
DS1	5040003140	S.LED FRDG1211C-TR	B	43.5/74.5

M.=Mounted side (T: Mounted on the Top side, B: Mounted on the Bottom side)  
S.=Surface mount

# SECTION 7 MECHANICAL PARTS AND DISASSEMBLY

## [CHASSIS PARTS]

REF. NO.	ORDER NO.	DESCRIPTION	QTY.
J1	6510025010	Antenna connector SMA-R2869	1
SP1	2510000840	Speaker CS028014-12	1
W1	8900010960	Cable OPC-1129	1
MP1	8010020240	2869 chassis	1
MP2	8210022691	2869 front panel (B)-1 (including MP23)	1
MP3	8110008860	2869 cover (A)	1
MP4	8310065250	2869 window plate (B)	1
MP5	8610012850	Knob N-340	1
MP6	8930068020	2869 key	1
MP7	8930068050	2869 window sheet	1
MP8	8810008990	Screw PH B0 2 × 10 ZK	2
MP9	8310065090	2869 lock plate	1
MP10	8930067850	2869 terminal holder	1
MP11	8930067770	2869 lens	1
MP12	8210022340	2869 reflector	1
MP13	8930067860	2869 PTT button	1
MP14	8930067870	2869 PTT plate	1
MP15	8930067880	2869 LCD holder	1
MP16	8930067890	2869 plus terminal	1
MP17	8930067900	2869 minus terminal	1
MP18	8930067910	2869 A-terminal	3
MP19	8930067790	2869 shaft	1
MP20	8930067920	2869 ANT plate	1
MP21	8930067930	2869 mic sponge	1
MP22	8930068720	2869 A-white sheet	1
MP23	8930050220	1903 SP net	1
MP24	8830001340	1903 hex nut	1
MP25	8930059610	Sponge (HC)	1
MP26	8610007510	Knob spring NO.7800	1
MP27	8810005920	Screw PH M2 × 10 ZK	2
MP28	8810005700	Screw PH M2 × 4 ZK	1
MP29	8810009510	Screw PH B0 2 × 4 NI-ZU	4
MP30	8810009560	Screw PH B0 2 × 6 ZK	1
MP32	8930024310	1121 mic sheet	1
MP33	8930067990	2869 jack cap	1
MP34	8310065050	2869 front plate	1
MP35	8930068040	Knob N-340 rubber	1
MP36	8930068410	2869 rear sheet	1
MP37	8830002700	2869 nut	1
MP42	8930069440	Shield sponge (AV)	1

## [VCO BOARD]

REF. NO.	ORDER NO.	DESCRIPTION	QTY.
MP1	8510017530	2869 A-VCO case	1

## [PA BOARD]

REF. NO.	ORDER NO.	DESCRIPTION	QTY.
MP1	8510017660	2869 PTT shield	1

## [MAIN UNIT]

REF. NO.	ORDER NO.	DESCRIPTION	QTY.
S8	7600000210	Encoder TP70N00E2015F-1903	1
J4	6450001910	SP/MIC jack HSJ1594-010150	1
DS1	5030002860	LCD A01B004X	1
MC1	7700002310	Microphone EM-140	1
EP2	8930068460	LCD contact SRCN-2869-S-N-C	1
MP1*	8510017510	2869 earth plate	1
MP2*	8930068920	Double side tape (AQ)	1

\*: Refer to page 9-1.

**Screw abbreviations**      B0: Self-tapping  
 PH: Pan head      ZK: Black  
 NI-ZU: Nickel-Zinc

## [ACCESSORIES]

REF. NO.	ORDER NO.	DESCRIPTION	QTY.
EP1	Optional product	BP-243	1
EP2	Optional product	BC-164 EUR      [EUR], [ITR], [FRA]	1
	Optional product	BC-164 UK      [UK]	1
EP3	3310003550	2869 ANT	1
MP1	8010018080	Handstrap HK-009	1

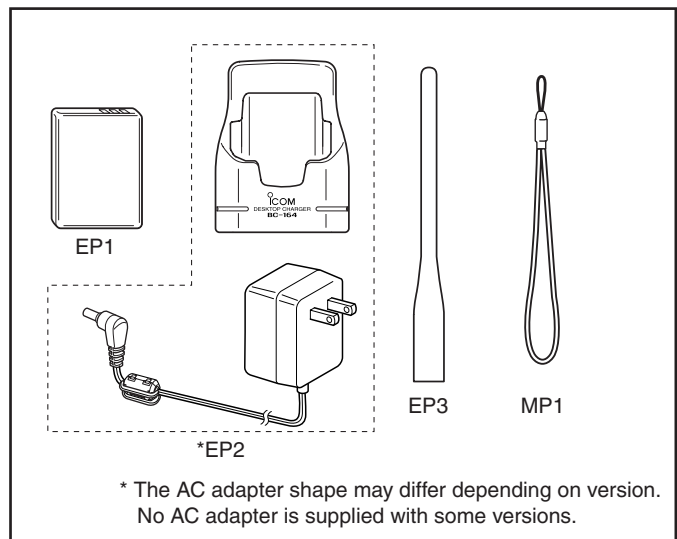

\* The AC adapter shape may differ depending on version.  
 No AC adapter is supplied with some versions.

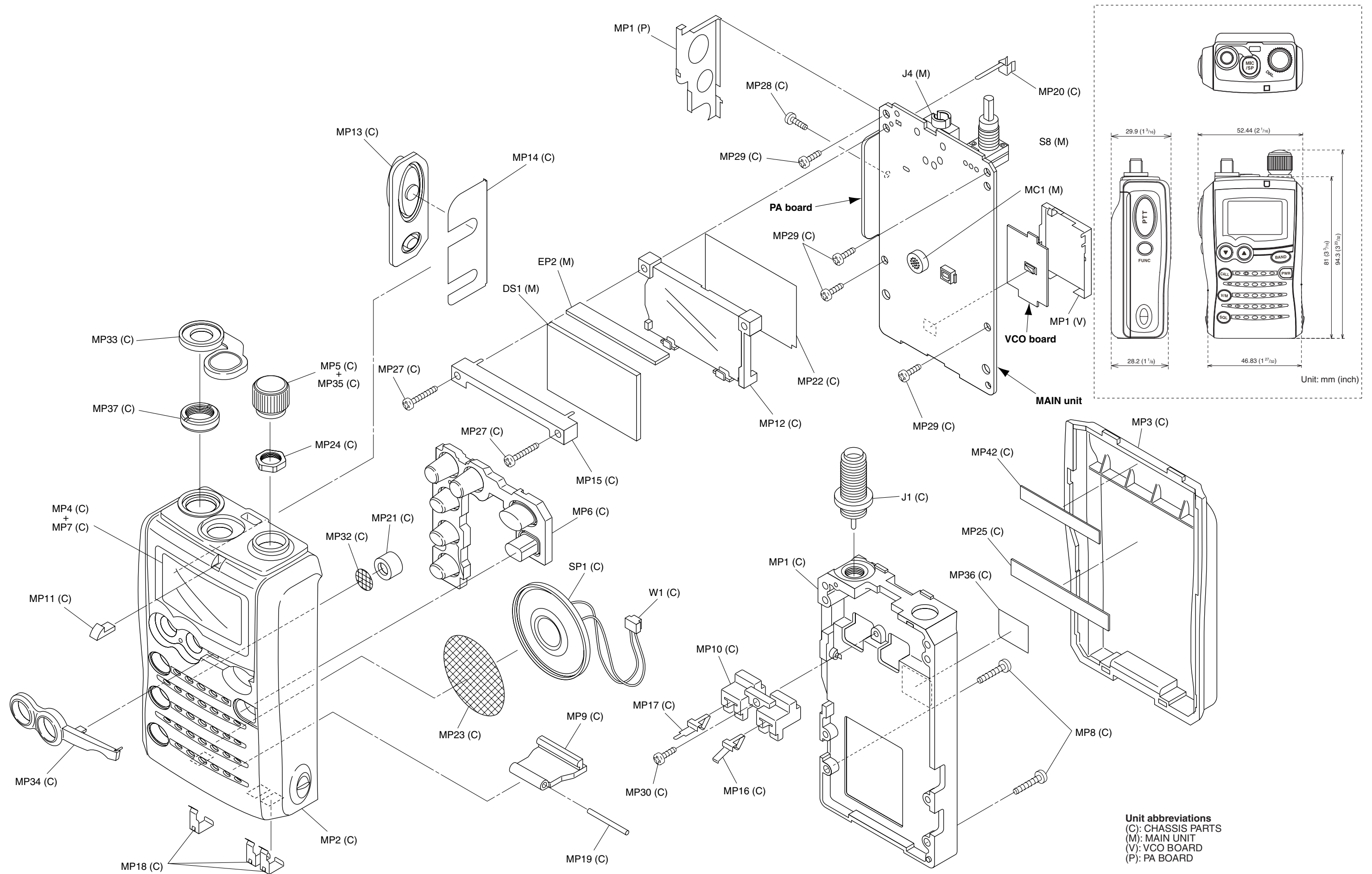

# SECTION 8 SEMICONDUCTOR INFORMATION

## • TRANSISTORS AND FET'S

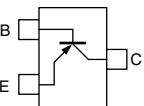
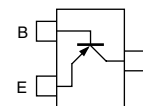
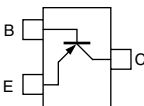
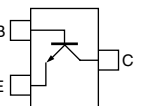
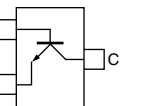
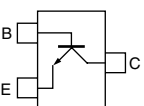
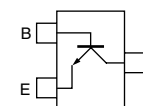
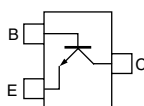
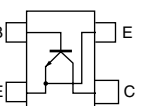
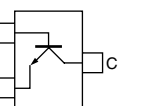
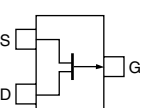
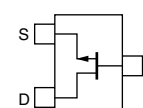
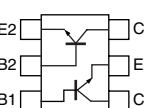
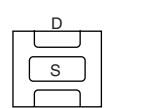
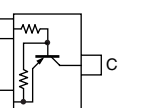
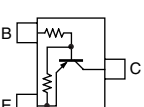
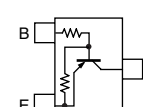
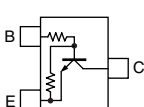
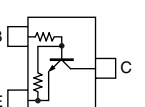
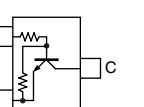
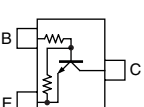
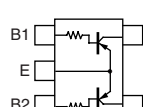
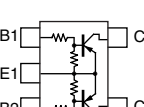
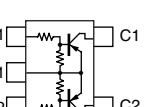
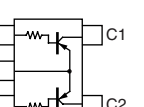
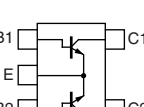
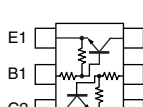
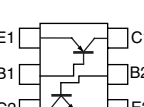
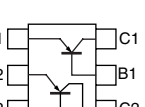
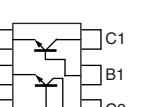
<b>2SA1576 S</b> (Symbol: FS) 	<b>2SA1588 GR</b> (Symbol: ZG) 	<b>2SA1832 GR</b> (Symbol: SG) 	<b>2SC4213 B</b> (Symbol: AB) 	<b>2SC4617 S</b> (Symbol: BR) 
<b>2SC5006</b> (Symbol: 24) 	<b>2SC5108 Y</b> (Symbol: MC) 	<b>2SC5277 D2</b> (Symbol: D2) 	<b>2SC5508</b> (Symbol: T79) 	<b>2SC5998</b> (Symbol: YC-) 
<b>2SJ144 GR</b> (Symbol: VG) 	<b>2SK880 Y</b> (Symbol: XY) 	<b>FH102</b> (Symbol: 102) 	<b>RQA0003</b> * Bottom view (Symbol: A0003) 	<b>UNR9113J</b> (Symbol: 6C) 
<b>UNR9114J</b> (Symbol: 6D) 	<b>UNR9115J</b> (Symbol: 6E) 	<b>UNR9210J</b> (Symbol: 8L) 	<b>UNR9211J</b> (Symbol: 8A) 	<b>UNR9213J</b> (Symbol: 8C) 
<b>UNR9215J</b> (Symbol: 8E) 	<b>XP1110</b> (Symbol: AD) 	<b>XP1113</b> (Symbol: 7L) 	<b>XP1114</b> (Symbol: 7Q) 	<b>XP1115</b> (Symbol: 9L) 
<b>XP1501 AB</b> (Symbol: 5R) 	<b>XP4214</b> (Symbol: BR) 	<b>XP4601</b> (Symbol: 5C) 	<b>XP6401</b> (Symbol: 5O) 	<b>XP6501 AB</b> (Symbol: 5N) 

## • DIODES

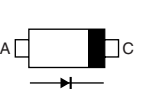
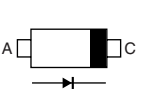
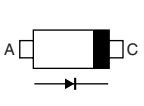
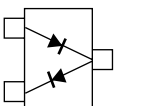
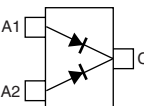
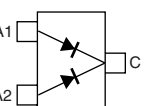
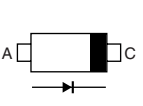
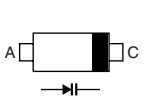
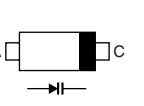
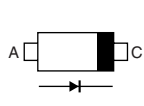
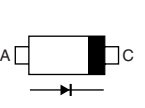
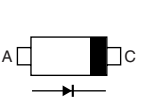
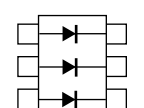
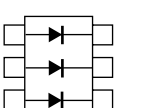
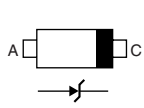
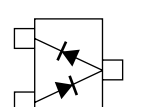
<b>1SS400</b> (Symbol: A) 	<b>1SV286</b> (Symbol: T7) 	<b>1SV308</b> (Symbol: TX) 	<b>DA221</b> (Symbol: K) 	<b>DAN222</b> (Symbol: N) 
<b>DAN235E</b> (Symbol: M) 	<b>HVC132</b> (Symbol: P2) 	<b>HVC350B</b> (Symbol: B0) 	<b>HVD328C</b> (Symbol: A5) 	<b>MA2S077</b> (Symbol: S) 
<b>MA2S111</b> (Symbol: A) 	<b>MA2S728</b> (Symbol: B) 	<b>MA6S121</b> (Symbol: M2D) 	<b>MA6S718</b> (Symbol: M2N) 	<b>MA8051 L</b> (Symbol: 5_1) 
<b>RB876W TL</b> (Symbol: 3X) 				



# SECTION 9 BOARD LAYOUTS

**9-1 MAIN UNIT**  
• TOP VIEW

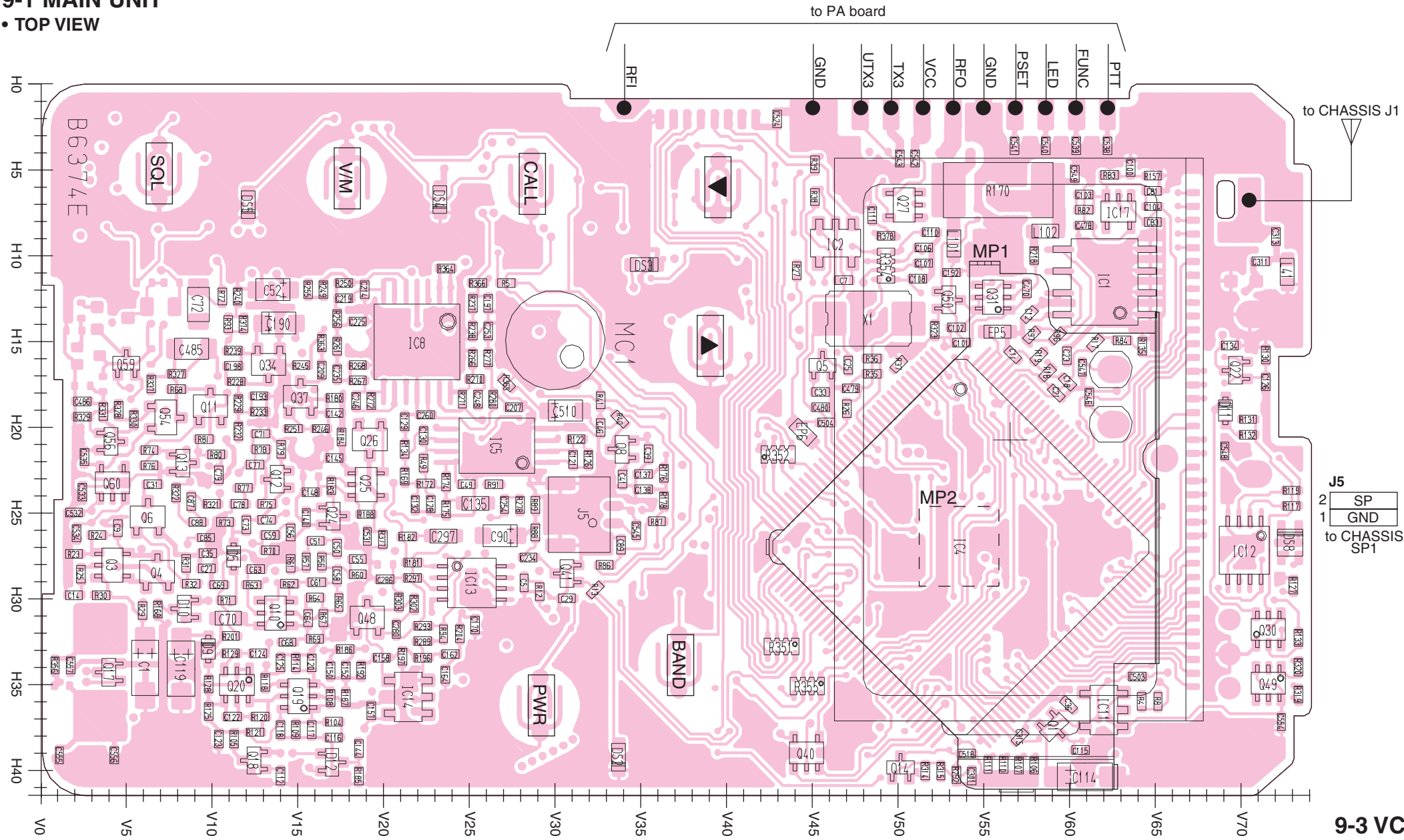

**9-4 BC-164**  
• TOP VIEW

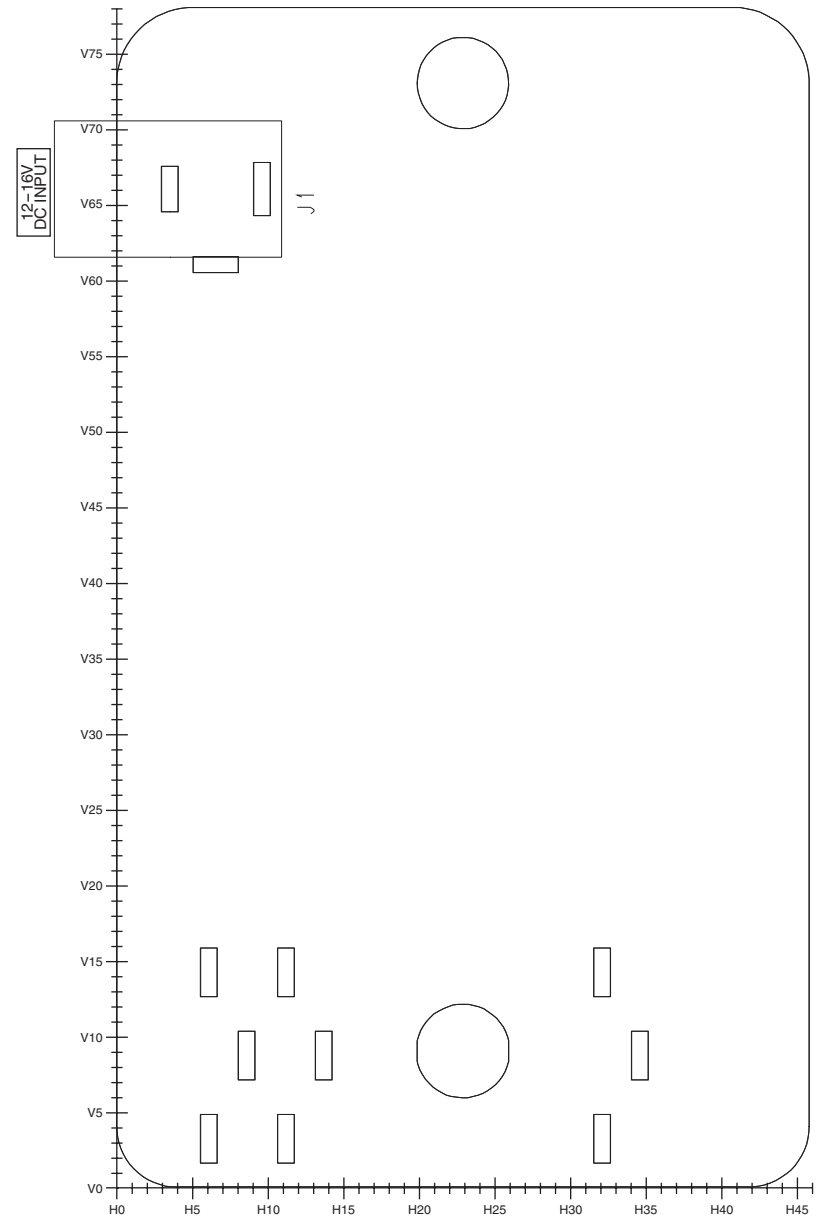

**9-2 PA BOARD**  
• TOP VIEW

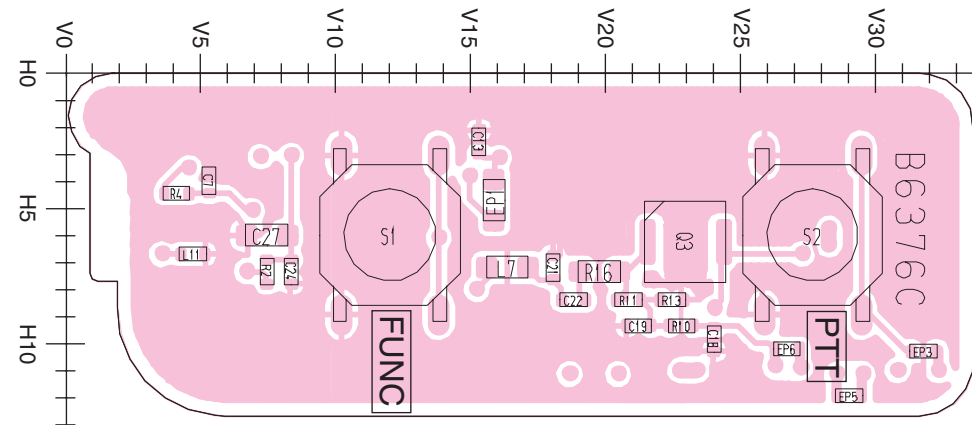

**9-3 VCO BOARD**  
• TOP VIEW

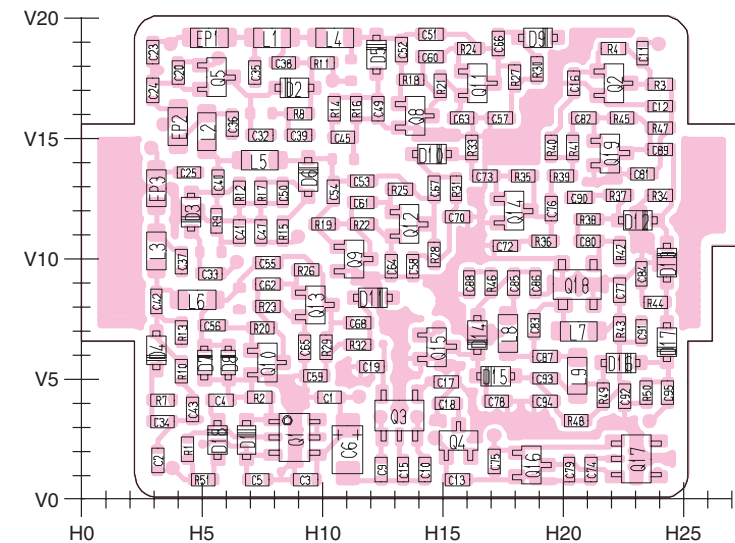

Downloaded by  
RadioAmateur.EU



• BOTTOM VIEW (BC-164)

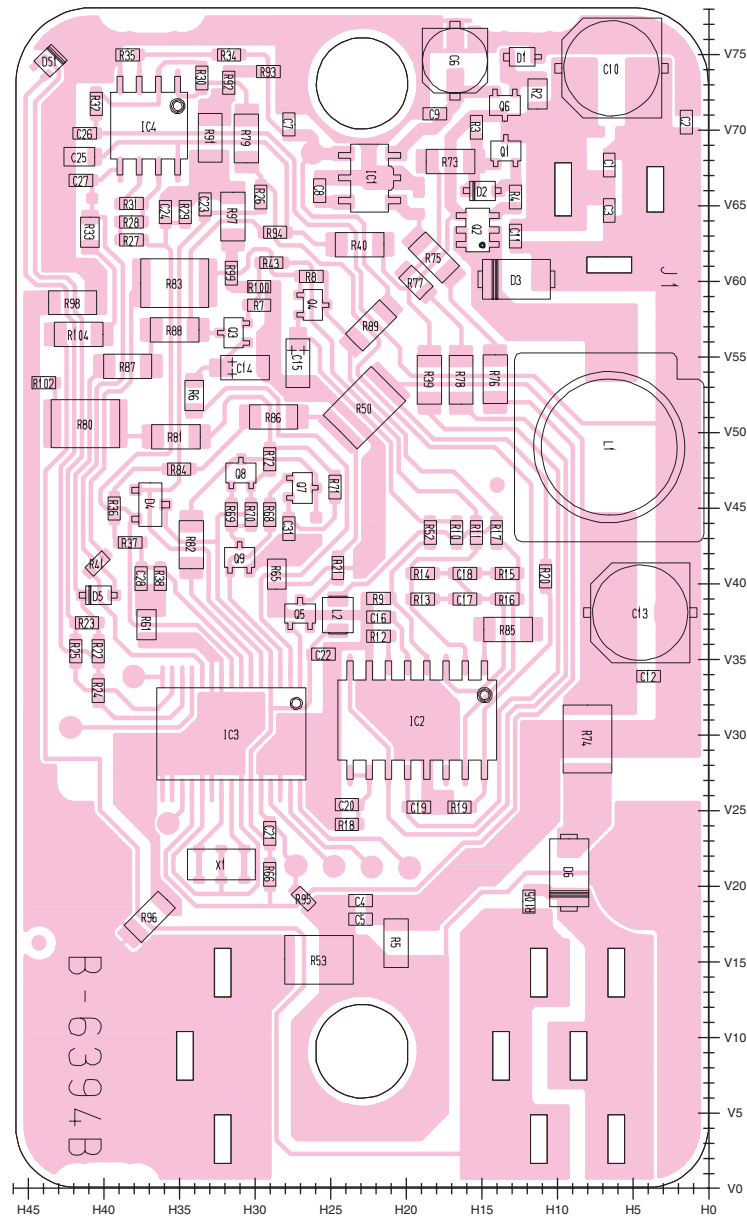

• BOTTOM VIEW (MAIN UNIT)

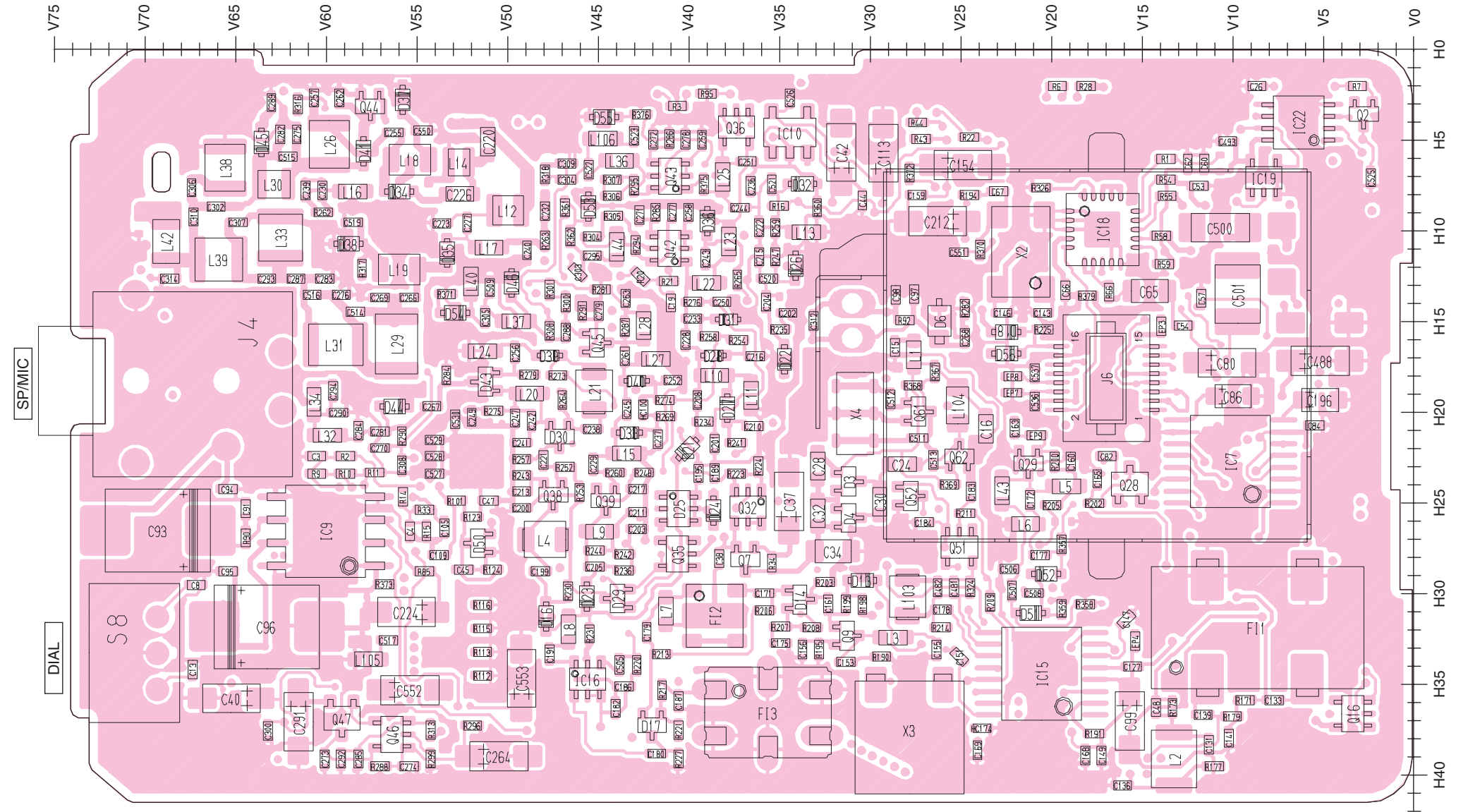

• BOTTOM VIEW (VCO BOARD)

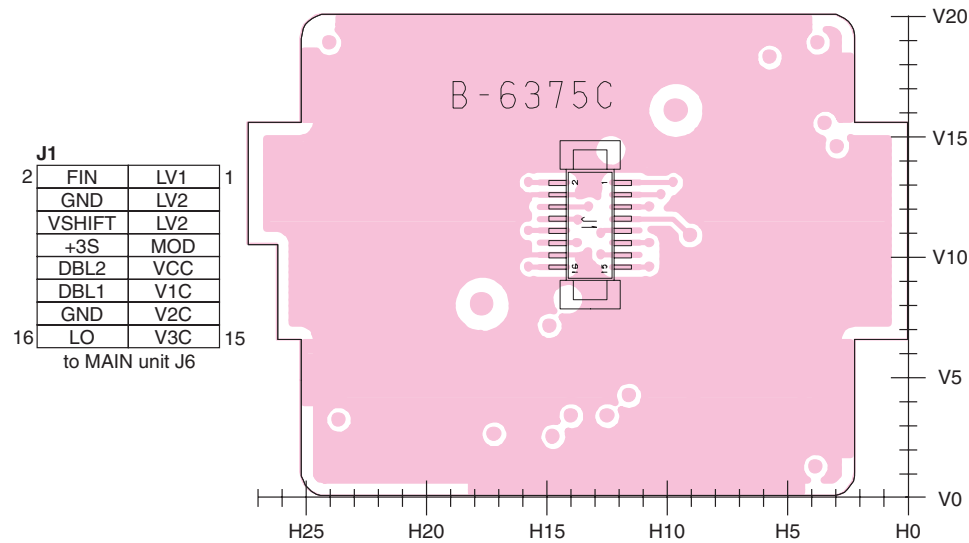

• BOTTOM VIEW (PA BOARD)

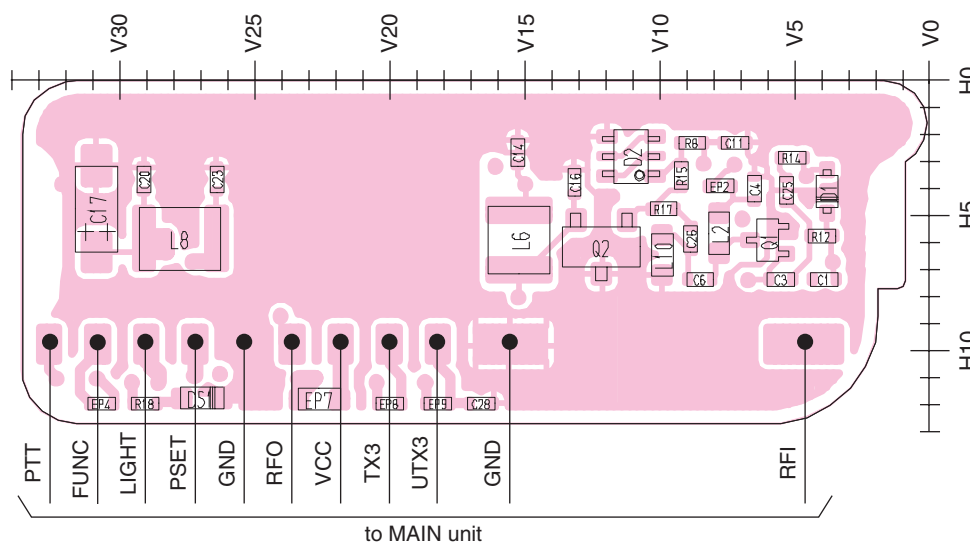

# SECTION 10 BLOCK DIAGRAM

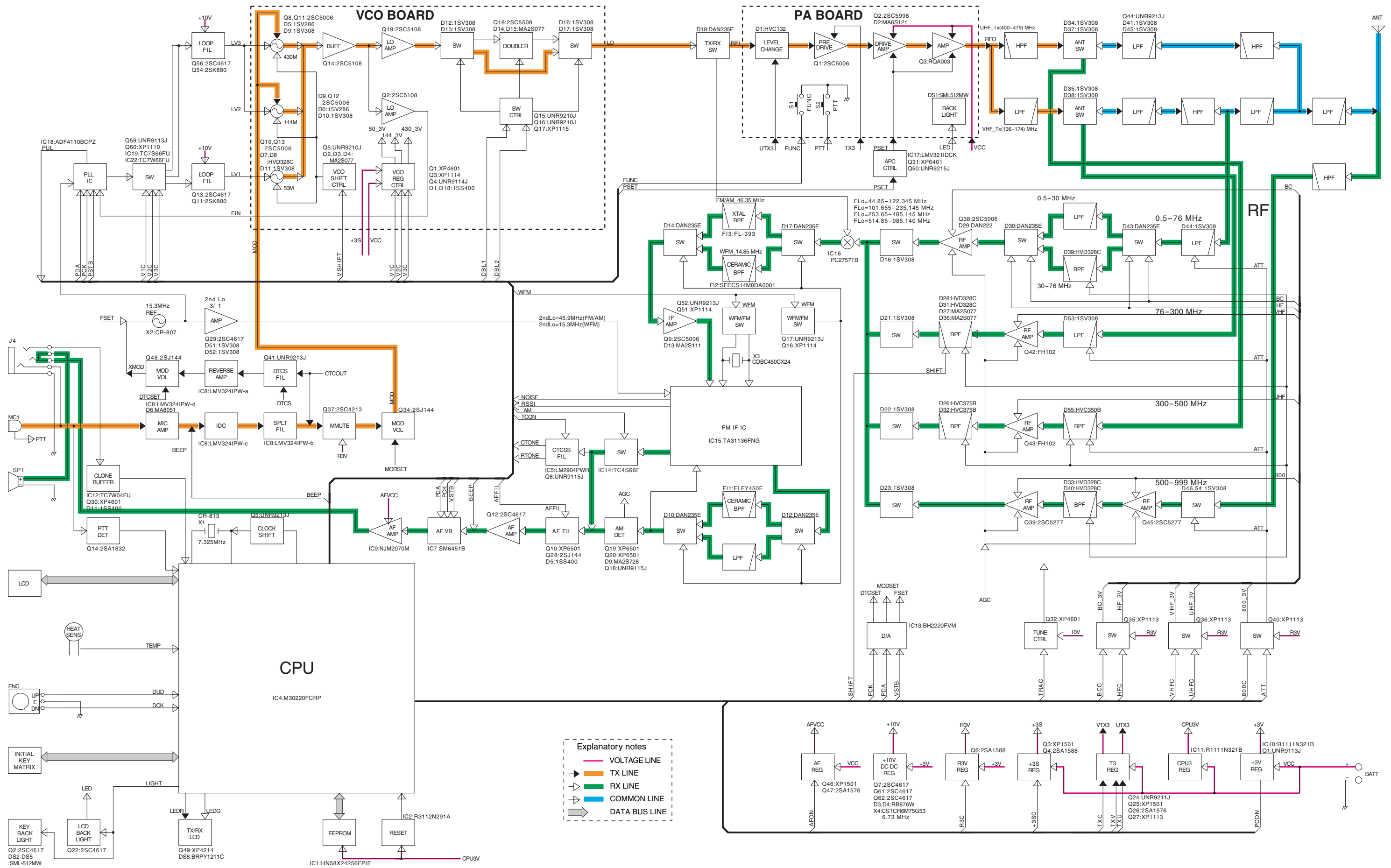

# SECTION 11 CIRCUIT DIAGRAM

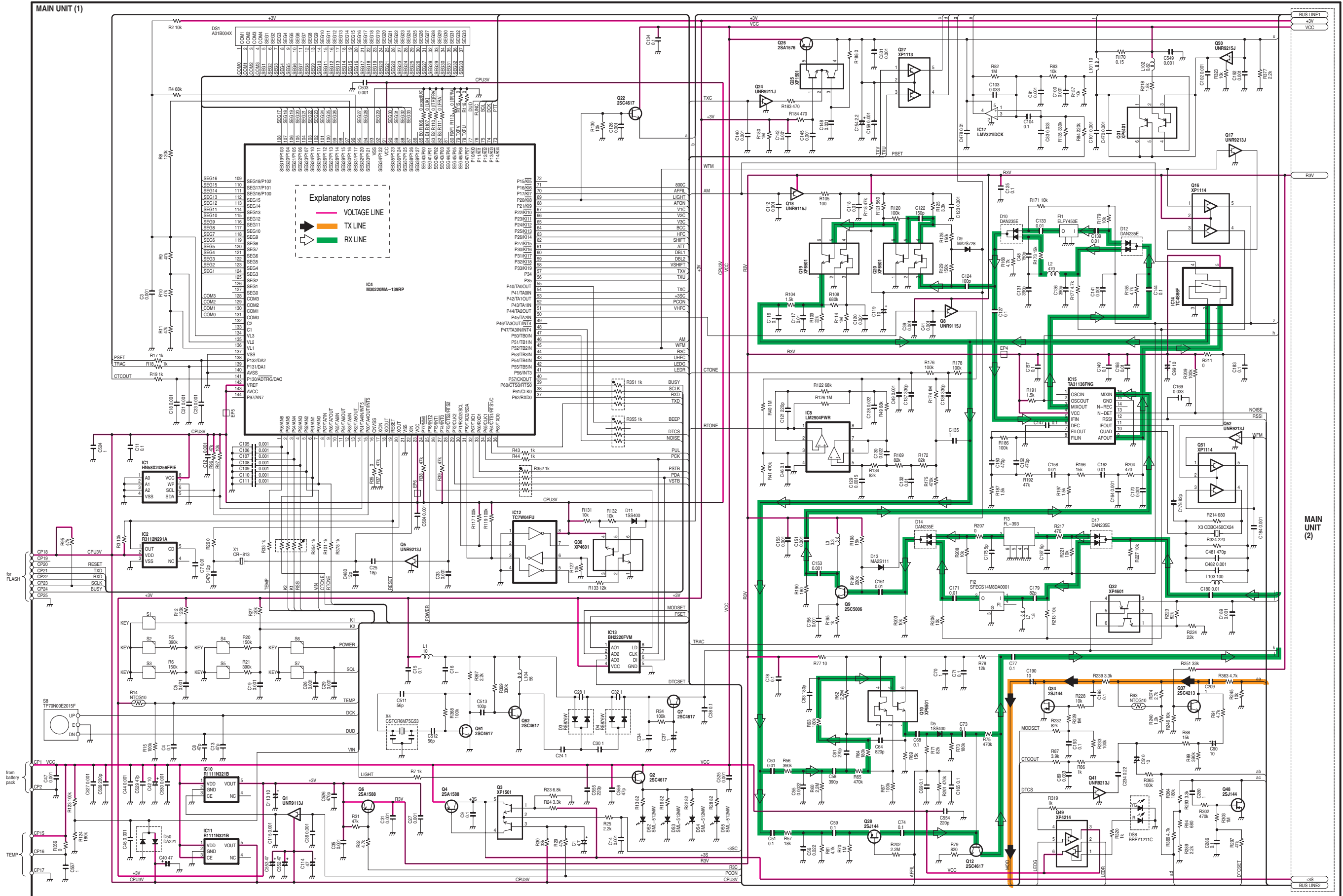

Downloaded by  
Radioamateur.EU



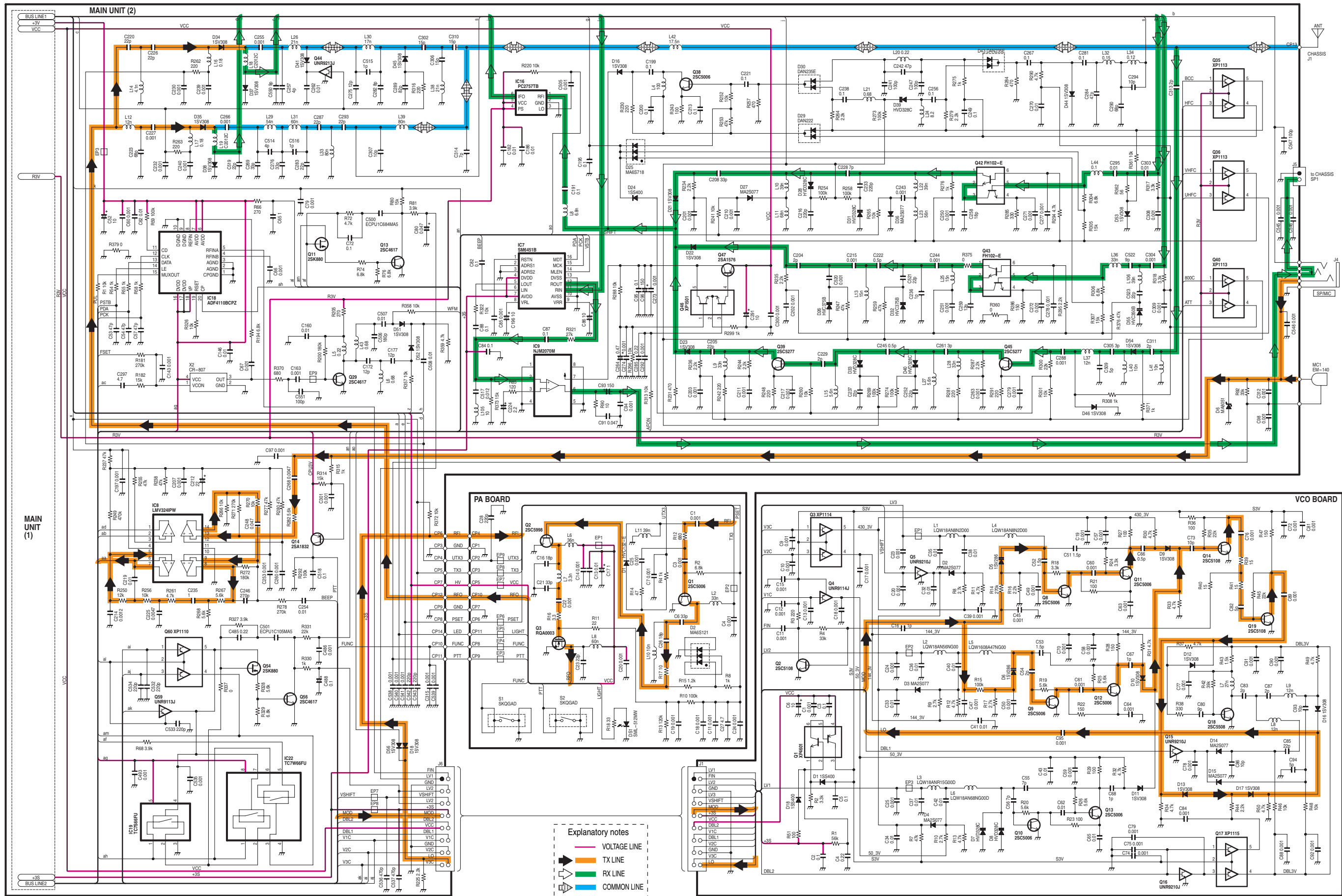

# SECTION 12 BC-164

## [CHASSIS PARTS]

REF. NO.	ORDER NO.	DESCRIPTION	QTY.
MP1	8010020220	2878 case	1
MP2	8110008590	2878 cover	1
MP3	8930067800	2878 lens	1
MP4	8930067810	2878 lock plate	2
MP5	8930067830	2878 springe	2
MP6	8930067820	2878 terminal	3
MP7	8930039620	Stand cushion (A)	2
MP8	8810009990	Screw PH B0 3 x 8 ZK (BT)	4
MP9	8810008630	Screw PH B0 3 x 6 NI-ZU (BT)	2

## [MAIN UNIT]

REF. NO.	ORDER NO.	DESCRIPTION	QTY.
J1	6510024940	Connector HEC2305-016250	1
DS1	5040003140	LED FRDG1211C	1

**Screw abbreviation**  
 B0: Self tapping  
 PH: Pan head      ZK: Zinc  
 NI-ZU: Nickell-Zinc

## [ACCESSORIES]

REF. NO.	ORDER NO.	DESCRIPTION	QTY.
EP1	Optional product	AC adaptor BC-145LE/LUK	1

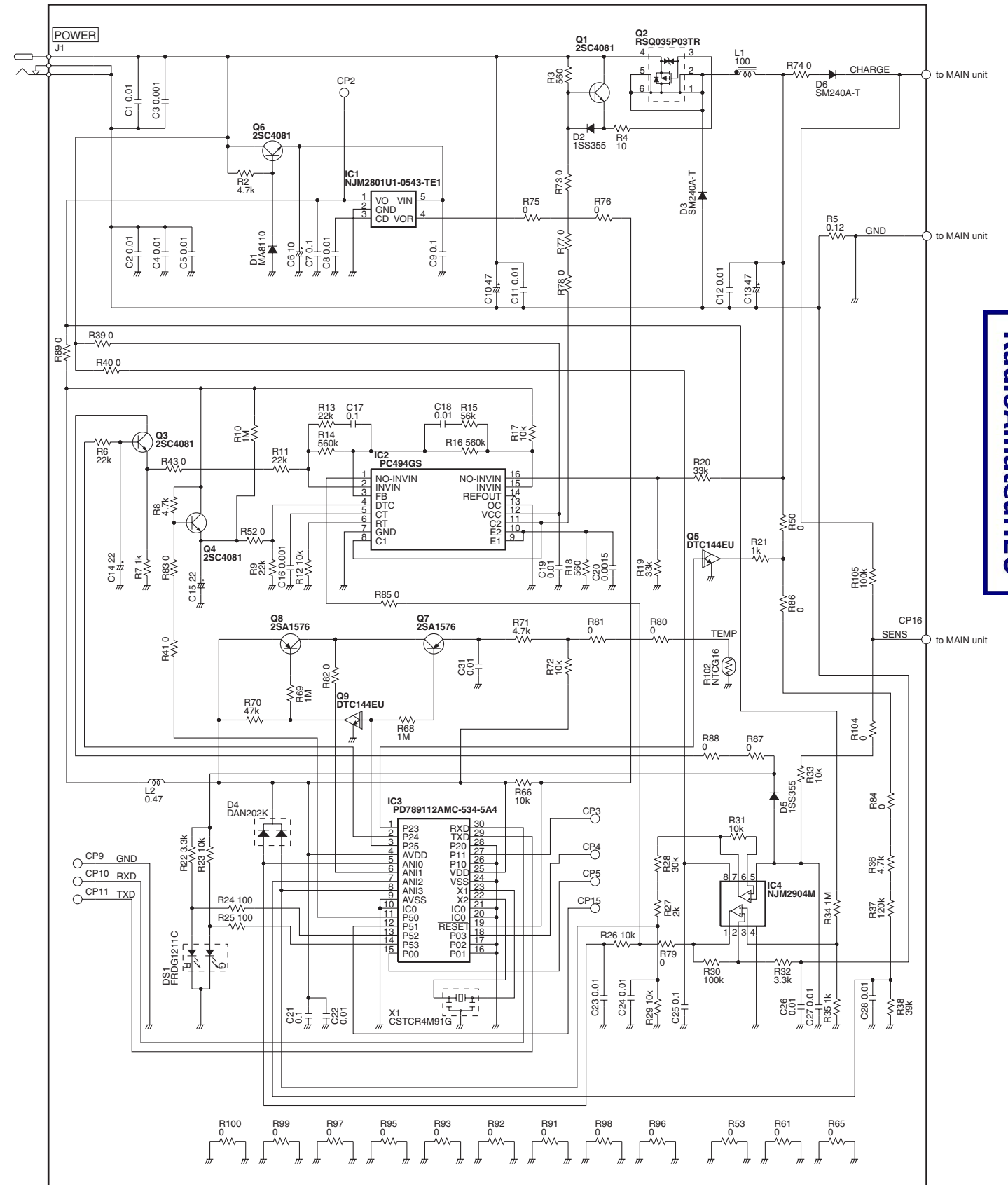
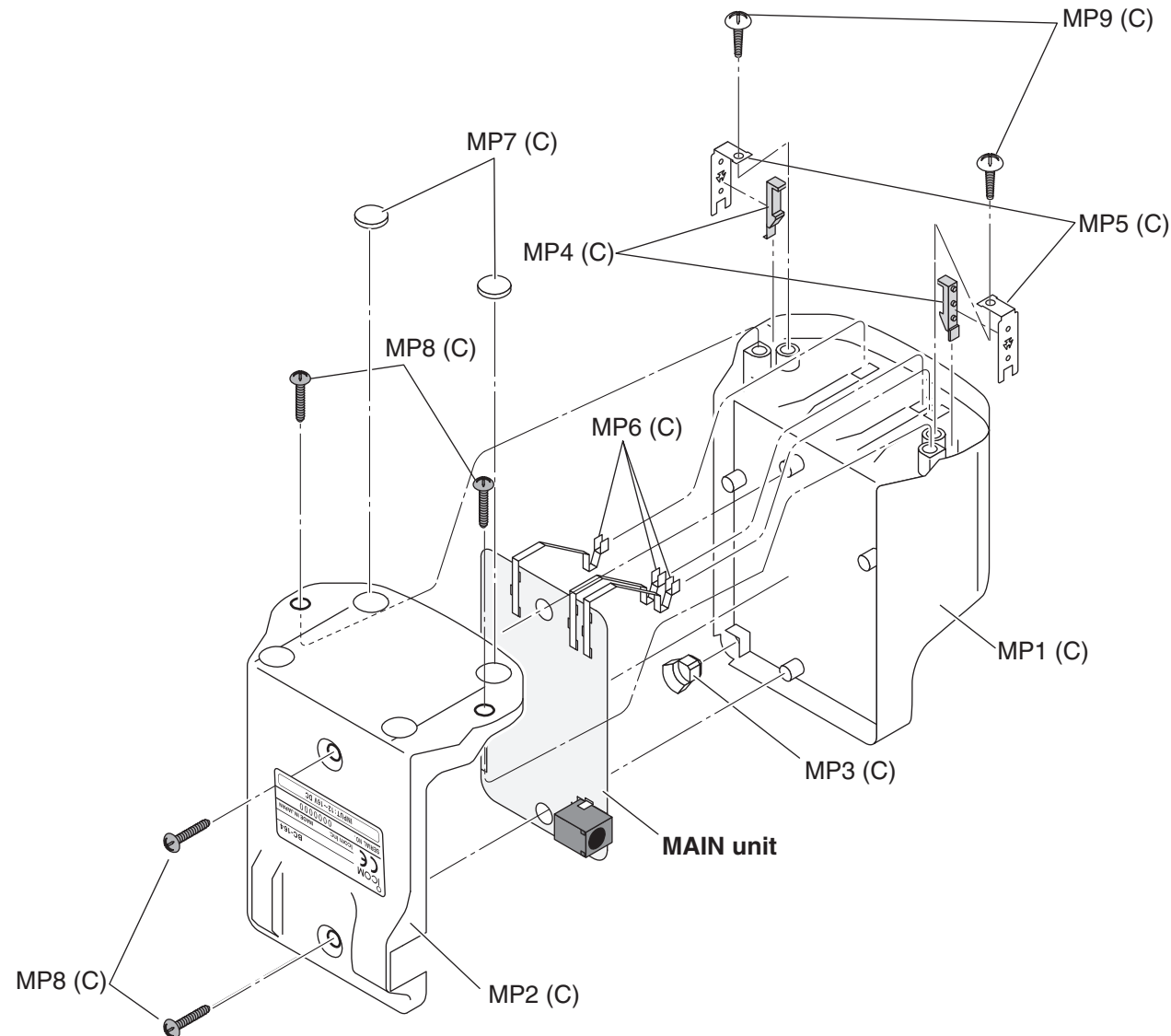
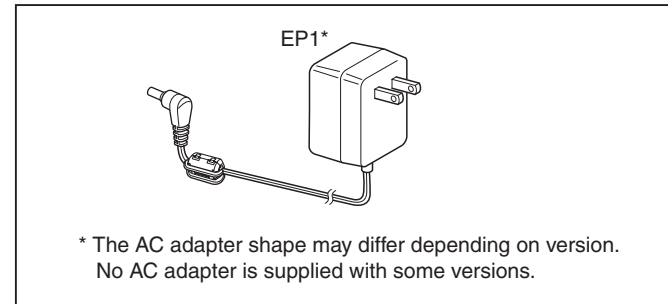

Downloaded by RadioAmateur.EU



## Icom Inc.

1-1-32, Kamiminami, Hirano-ku, Osaka 547-0003, Japan  
Phone : +81 (06) 6793 5302  
Fax : +81 (06) 6793 0013  
URL : <http://www.icom.co.jp/world/index.html>

### Icom America Inc.

<Corporate Headquarters>  
2380 116th Avenue N.E., Bellevue, WA 98004, U.S.A.  
Phone : +1 (425) 454-8155 Fax : +1 (425) 454-1509  
URL : <http://www.icomamerica.com>  
E-mail : [sales@icomamerica.com](mailto:sales@icomamerica.com)  
<Customer Service>  
Phone : +1 (425) 454-7619

### Icom Canada

Glenwood Centre #150-6165  
Highway 17 Delta, B.C., V4K 5B8, Canada  
Phone : +1 (604) 952-4266 Fax : +1 (604) 952-0090  
URL : <http://www.icomcanada.com>  
E-mail : [info@icomcanada.com](mailto:info@icomcanada.com)

### Icom (Australia) Pty. Ltd.

A.B.N. 88 006 092 575  
Unit 1 / 103 Garden Road, Clayton VIC 3168 Australia  
Phone : +61 (03) 9549-7500 Fax : +61 (03) 9549-7505  
URL : <http://www.icom.net.au>  
E-mail : [sales@icom.net.au](mailto:sales@icom.net.au)

### Icom New Zealand

146A Harris Road, East Tamaki,  
Auckland, New Zealand  
Phone : +64 (09) 274 4062 Fax : +64 (09) 274 4708  
URL : <http://www.icom.co.nz>  
E-mail : [inquiries@icom.co.nz](mailto:inquiries@icom.co.nz)

### Beijing Icom Ltd.

Room C01, 10th Floor, Long Silver Mansion, No. 88,  
Yong Ding Road, Haidian District, Beijing, 100039, China  
Phone : +86 (010) 5889 4250 Fax : +86 (010) 5889 4250  
URL : <http://www.bjicom.com>  
E-mail : [bjicom@bjicom.com](mailto:bjicom@bjicom.com)

### Icom (Europe) GmbH

Communication Equipment  
Himmelgeister Str. 100, D-40225 Düsseldorf, Germany  
Phone : +49 (0211) 346047 Fax : +49 (0211) 333639  
URL : <http://www.icomeurope.com>  
E-mail : [info@icomeurope.com](mailto:info@icomeurope.com)

### Icom Spain S.L

Ctra. Rubi, 88, 08190, Sant Cugat del Valles, Barcelona, SPAIN  
Phone : +34 (93) 590 26 70 Fax : +34 (93) 589 04 46  
URL : <http://www.icomspain.com>  
E-mail : [icom@icomspain.com](mailto:icom@icomspain.com)

### Icom (UK) Ltd.

Unit 9, Sea St., Herne Bay, Kent, CT6 8LD, U.K.  
Phone : +44 (01227) 741741 Fax : +44 (01227) 741742  
URL : <http://www.icomuk.co.uk>  
E-mail : [info@icomuk.co.uk](mailto:info@icomuk.co.uk)

### Icom France S.a

Zac de la Plaine, 1, Rue Brindejone des Moulinais  
BP 5804, 31505 Toulouse Cedex, France  
Phone : +33 (5) 61 36 03 03 Fax : +33 (5) 61 36 03 00  
URL : <http://www.icom-france.com>  
E-mail : [icom@icom-france.com](mailto:icom@icom-france.com)

### Asia Icom Inc.

6F No.68, Sec. 1 Cheng-Teh Road, Taipei, Taiwan, R.O.C.  
Phone : +886 (02) 2559 1899 Fax : +886 (02) 2559 1874  
URL : <http://www.asia-icom.com>  
E-mail : [sales@asia-icom.com](mailto:sales@asia-icom.com)

### Icom Polska

Sopot, 3 Maja 54 Poland  
Phone : +48 (58) 550 7135 Fax : +48 (58) 551 0484  
E-mail : [icompolska@icompolska.com.pl](mailto:icompolska@icompolska.com.pl)

**Count on us!**

**Icom Inc.**

1-1-32, Kamiminami, Hirano-ku, Osaka 547-0003, Japan

Download from [www.semanuals.com](http://www.semanuals.com). All Manuals Search And Download.

S-14217HZ-C1  
© 2005 Icom Inc.

## Free Manuals Download Website

<http://myh66.com>

<http://usermanuals.us>

<http://www.somanuals.com>

<http://www.4manuals.cc>

<http://www.manual-lib.com>

<http://www.404manual.com>

<http://www.luxmanual.com>

<http://aubethermostatmanual.com>

Golf course search by state

<http://golfingnear.com>

Email search by domain

<http://emailbydomain.com>

Auto manuals search

<http://auto.somanuals.com>

TV manuals search

<http://tv.somanuals.com>