

HF/50 MHz TRANSCEIVER
IC-7700
Instruction Manual

Downloaded by
RadioAmateur.EU

A-6612H-1EX
Printed in Japan
© 2007 Icom Inc.

FOREWORD

Thank you for making the IC-7700 your radio of choice. We hope you agree with Icom's philosophy of "technology first." Many hours of research and development went into the design of your IC-7700.

◇ **FEATURES**

- *Ultimate receiver performance: third-order intercept (IP3) of +40 dBm (HF bands only)*
- *Built-in Baudot RTTY and PSK31 modulator/demodulator and direct PC keyboard connection capability for RTTY and PSK31 operation without a PC*
- *High resolution spectrum scope— center frequency and fixed frequency modes, plus mini-scope displays*

IMPORTANT

READ THIS INSTRUCTION MANUAL CAREFULLY before attempting to operate the transceiver.

SAVE THIS INSTRUCTION MANUAL. This manual contains important safety and operating instructions for the IC-7700.

EXPLICIT DEFINITIONS

WORD	DEFINITION
⚠ WARNING	Personal injury, fire hazard or electric shock may occur.
CAUTION	Equipment damage may occur.
NOTE	If disregarded, inconvenience only. No risk of personal injury, fire or electric shock.

TRADEMARKS

Icom, Icom Inc. and the  logo are registered trademarks of Icom Incorporated (Japan) in the United States, the United Kingdom, Germany, France, Spain, Russia and/or other countries.

PRECAUTIONS

⚠ WARNING HIGH RF VOLTAGE! NEVER attach an antenna or internal antenna connector during transmission. This may result in an electrical shock or burn.

⚠ WARNING! NEVER operate the transceiver with a headset or other audio accessories at high volume levels. Hearing experts advise against continuous high volume operation. If you experience a ringing in your ears, reduce the volume or discontinue use.

⚠ CAUTION! NEVER change the internal settings of the transceiver. This may reduce transceiver performance and/or damage to the transceiver.

In particular, incorrect settings for transmitter circuits, such as output power, idling current, etc., might damage the expensive final devices.

The transceiver warranty does not cover any problems caused by unauthorized internal adjustment.

⚠ CAUTION! NEVER touch the transceiver top cover when transmitting continuously for long periods. The top cover may be hot.

⚠ CAUTION! NEVER let metal, wire or other objects protrude into the transceiver or into connectors on the rear panel. This may result in an electric shock.

⚠ CAUTION! NEVER block any cooling vents on the top, rear or bottom of the transceiver.

⚠ CAUTION! NEVER expose the transceiver to rain, snow or any liquids.

⚠ CAUTION! NEVER install the transceiver in a place without adequate ventilation. Heat dissipation may be reduced, and the transceiver may be damaged.

⚠ CAUTION! NEVER operate or touch the transceiver with wet hands. This may result in an electric shock or damage to the transceiver.

⚠ CAUTION! The transceiver weighs approx. 22.5 kg (50 lb). Always have two people available to carry, lift or turn over the transceiver.

⚠ CAUTION! The line-voltage receptacle must be near the transceiver and must be easily accessible. Avoid extension cords.

DO NOT use chemical agents such as benzine or alcohol when cleaning the IC-7700, as they can damage the transceiver's surfaces.

DO NOT push the PTT switch when you don't actually desire to transmit.

AVOID using or storing the transceiver in areas with temperatures below $\pm 0^{\circ}\text{C}$ ($+32^{\circ}\text{F}$) or above $+50^{\circ}\text{C}$ ($+122^{\circ}\text{F}$).

AVOID placing the transceiver in excessively dusty environments or in direct sunlight.

AVOID placing the transceiver against walls or putting anything on top of the transceiver. This may overheat the transceiver.

Always place unit in a secure place to avoid inadvertent use by children.

BE CAREFUL! If you use a linear amplifier, set the transceiver's RF output power to less than the linear amplifier's maximum input level, otherwise, the linear amplifier will be damaged.

Use Icom microphones only (supplied or optional). Other manufacturers' microphones have different pin assignments, and connection to the IC-7700 may damage the transceiver or microphone.

The LCD display may have cosmetic imperfections that appear as small dark or light spots. This is not a malfunction or defect, but a normal characteristic of LCD displays.

During maritime mobile operation, keep the transceiver and microphone as far away as possible from the magnetic navigation compass to prevent erroneous indications.

Turn [I/O] switch (on the rear panel) OFF and/or disconnect the AC power cable from the AC outlet when you will not use the transceiver for long period of time.

For U.S.A. only

CAUTION: Changes or modifications to this device, not expressly approved by Icom Inc., could void your authority to operate this device under FCC regulations.

SUPPLIED ACCESSORIES

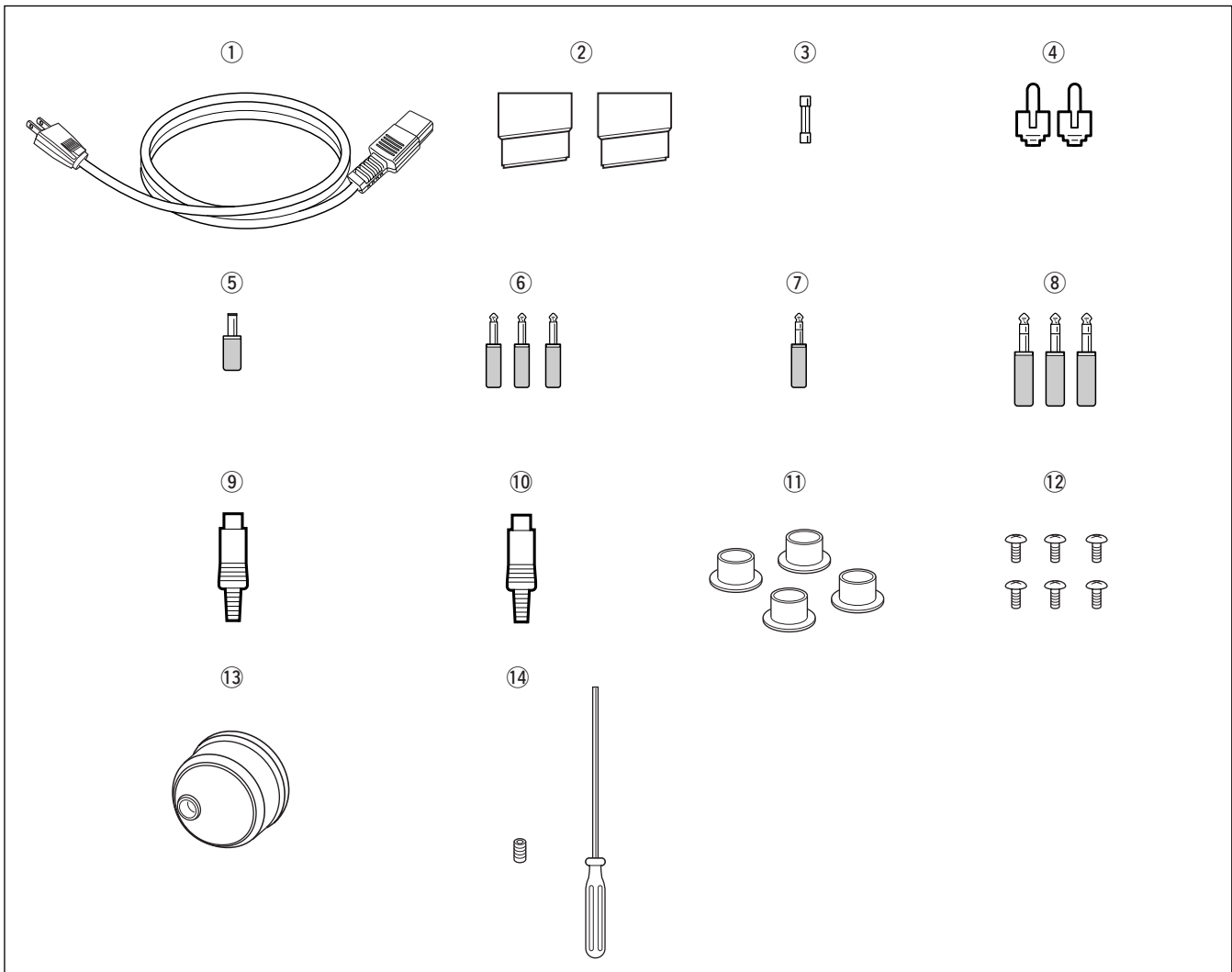

- ① AC power cable* 1
- ② Feet 1 pair
- ③ Spare fuse (FGB 2 A) 1
- ④ RCA plugs 2
- ⑤ DC plug 1
- ⑥ 2-conductor 1/8" plugs 3
- ⑦ 3-conductor 1/8" plugs 2
- ⑧ 3-conductor 1/4" plugs 3
- ⑨ ACC plugs (7-pin) 1
- ⑩ ACC plugs (8-pin) 1
- ⑪ Antenna connector caps 4
- ⑫ Hiding screws for screw hole† 6
- ⑬ Main dial‡ 1
- ⑭ Main dial screw and hexagonal wrench‡ 1 set

*May differ from that shown according to version.

†These screw are used when removing rack mounting handles. See p.2-3 for rack mounting handle detachment details.

‡See p.2-2 for main dial attachment details.

TABLE OF CONTENTS

Section 1	PANEL DESCRIPTION	
	■ Front panel	1-2
	■ Rear panel	1-12
	■ LCD display	1-14
	■ Screen menu arrangement	1-16
Section 2	INSTALLATION AND CONNECTIONS	
	■ Unpacking	2-2
	■ Main dial attachment	2-2
	■ Rack mounting handle detachment	2-3
	■ Selecting a location	2-3
	■ Grounding	2-4
	■ Antenna connection	2-4
	■ USB-Memory connection	2-4
	■ Required connections	2-5
	◇ Front panel	2-5
	◇ Rear panel	2-5
	■ Advanced connections	2-6
	◇ Front panel	2-6
	◇ Rear panel—1	2-6
	◇ Rear panel—2	2-7
	■ Linear amplifier connections	2-8
	◇ Connecting the IC-PW1/EURO	2-8
	◇ Connecting a non-Icom linear amplifier	2-8
	■ Transverter jack information	2-9
	■ FSK and AFSK (SSTV) connections	2-9
	■ Microphone connector information	2-10
	■ Microphones (options)	2-10
	◇ SM-20	2-10
	◇ HM-36	2-10
	■ Accessory connector information	2-11
Section 3	BASIC OPERATIONS	
	■ When first applying power (CPU resetting)	3-2
	■ Initial settings	3-2
	■ Selecting VFO/memory mode	3-3
	■ VFO selection	3-3
	◇ Selecting VFO-A/VFO-B	3-3
	◇ VFO equalization	3-3
	■ Selecting an operating band	3-4
	◇ Using the band stacking registers	3-4
	■ Frequency setting	3-5
	◇ Tuning with the main dial	3-5
	◇ Direct frequency entry with the keypad	3-5
	◇ Quick tuning step	3-6
	◇ Selecting “kHz” step	3-6
	◇ 1/4 tuning step function	3-6
	◇ Selecting 1 Hz step	3-7
	◇ Auto tuning step function	3-7
	◇ Band edge warning beep	3-7
	■ Operating mode selection	3-8
	■ Volume setting	3-9
	■ RF gain adjustment	3-9
	■ Squelch level adjustment	3-9

TABLE OF CONTENTS

■ Meter indication selection	3-10
◇ Multi-function digital meter	3-10
◇ Meter type selection	3-11
■ Voice synthesizer operation	3-11
■ Basic transmit operation	3-12
◇ Transmitting	3-12
◇ Microphone gain adjustment	3-12
◇ Drive gain adjustment	3-13
Section 4 RECEIVE AND TRANSMIT	
■ Operating SSB	4-2
◇ Convenient functions for receive	4-2
◇ Convenient functions for transmit	4-3
◇ About 5 MHz band operation (USA version only)	4-3
■ Operating CW	4-4
◇ Convenient functions for receive	4-4
◇ Convenient functions for transmit	4-5
◇ About CW reverse mode	4-5
◇ About CW pitch control	4-5
◇ CW side tone function	4-5
◇ APF (Audio Peak Filter) operation	4-6
■ Electronic keyer functions	4-7
◇ Memory keyer screen	4-8
◇ Editing a memory keyer	4-9
◇ Contest number set mode	4-10
◇ Keyer set mode	4-11
■ Operating RTTY (FSK)	4-13
◇ Convenient functions for receive	4-14
◇ About RTTY reverse mode	4-14
◇ Twin peak filter	4-14
◇ Functions for the RTTY decoder indication	4-15
◇ Setting the decoder threshold level	4-15
◇ RTTY memory transmission	4-16
◇ Automatic transmission/reception setting	4-16
◇ Editing RTTY memory	4-17
◇ RTTY decode set mode	4-18
◇ Data saving	4-20
■ Operating PSK	4-21
◇ Convenient functions for receive	4-22
◇ About BPSK and QPSK modes	4-22
◇ Functions for the PSK decoder indication	4-23
◇ Setting the decoder threshold level	4-23
◇ PSK memory transmission	4-24
◇ Automatic transmission/reception setting	4-24
◇ Editing PSK memory	4-25
◇ PSK decode set mode	4-26
◇ Data saving	4-28
■ Operating AM	4-29
◇ Convenient functions for receive	4-29
◇ Convenient functions for transmit	4-30
■ Operating FM	4-31
◇ Convenient functions for receive	4-31
◇ Convenient functions for transmit	4-31

TABLE OF CONTENTS



	■ Repeater operation	4-32
	◇ Repeater tone frequency setting	4-33
	■ Tone squelch operation	4-34
	■ Data mode (AFSK) operation	4-35
Section 5	FUNCTIONS FOR RECEIVE	
	■ Spectrum scope screen	5-2
	◇ Center mode	5-2
	◇ Fixed mode	5-3
	◇ Mini scope screen indication	5-4
	◇ Scope set mode	5-4
	■ Preamplifier	5-9
	■ Attenuator	5-9
	■ RIT function	5-10
	◇ RIT monitor function	5-10
	■ AGC function	5-11
	◇ Selecting the preset value	5-11
	◇ Adjusting the AGC time constant	5-11
	◇ Setting the AGC time constant preset value	5-11
	■ Twin PBT operation	5-12
	■ IF filter selection	5-13
	◇ IF filter selection	5-13
	◇ Filter passband width setting (except FM mode)	5-13
	◇ Roofing filter selection	5-14
	◇ DSP filter shape	5-14
	◇ Filter shape set mode	5-14
	■ Noise blanker	5-16
	◇ NB set mode	5-16
	■ Noise reduction	5-17
	■ Dial lock function	5-17
	■ Notch function	5-18
	■ Digital selector	5-18
	■ Autotune function	5-19
Section 6	FUNCTIONS FOR TRANSMIT	
	■ VOX function	6-2
	◇ Using the VOX function	6-2
	◇ Adjusting the VOX function	6-2
	◇ VOX set mode	6-2
	■ Break-in function	6-3
	◇ Semi break-in operation	6-3
	◇ Full break-in operation	6-3
	■ Δ TX function	6-4
	◇ Δ TX monitor function	6-4
	■ Monitor function	6-4
	■ Transmit filter width setting (SSB only)	6-5
	■ Speech compressor (SSB only)	6-5
	■ Split frequency operation	6-6
	■ Quick split function	6-7
	◇ Split lock function	6-7

TABLE OF CONTENTS

Section 7 VOICE RECORDER FUNCTIONS

■ About digital voice recorder	7-2
■ Recording a received audio	7-3
◇ Basic recording	7-3
◇ One-touch recording	7-3
■ Playing the recorded audio	7-4
◇ Basic playing	7-4
◇ One-touch playing	7-4
■ Protect the recorded contents	7-5
■ Erasing the recorded contents	7-5
■ Recording a message for transmit	7-6
◇ Recording	7-6
◇ Confirming a message for transmit	7-6
■ Programming a memory name	7-7
■ Sending a recorded message	7-8
◇ Transmit level setting	7-8
■ Voice set mode	7-9
■ Saving a voice memory into the USB-Memory	7-10
◇ Saving the received audio memory	7-10
◇ Saving the TX memory	7-10

Section 8 MEMORY OPERATION

■ Memory channels	8-2
■ Memory channel selection	8-2
◇ Using the  /  keys	8-2
◇ Using the keypad	8-2
■ Memory channel programming	8-3
◇ Programming in VFO mode	8-3
◇ Programming in memory mode	8-3
■ Frequency transferring	8-4
◇ Transferring in VFO mode	8-4
◇ Transferring in memory mode	8-4
■ Memory list screen	8-5
◇ Selecting a memory channel using the memory list screen	8-5
◇ Confirming programmed memory channels	8-5
■ Memory names	8-6
◇ Editing (programming) memory names	8-6
■ Memory clearing	8-6
■ Memo pads	8-7
◇ Writing frequencies and operating modes into memo pads	8-7
◇ Calling up a frequency from a memo pad	8-7

Section 9 SCANS

■ Scan types	9-2
■ Preparation	9-2
■ Voice squelch control function	9-3
■ Scan set mode	9-3
■ Programmed scan operation	9-4
■ ΔF scan operation	9-4
■ Fine programmed scan/Fine ΔF scan	9-5
■ Memory scan operation	9-6
■ Select memory scan operation	9-6

TABLE OF CONTENTS

	■ Setting select memory channels	9-7
	◇ Setting in scan screen	9-7
	◇ Setting in memory list screen	9-7
	◇ Erasing the select scan setting	9-7
	■ Tone scan	9-8
Section 10	ANTENNA TUNER OPERATION	
	■ Antenna connection and selection	10-2
	■ Antenna memory settings	10-3
	◇ Antenna type selection	10-3
	◇ Temporary memory	10-4
	◇ Antenna selection mode	10-4
	◇ Receive antenna I/O setting	10-5
	■ Antenna tuner operation	10-6
	◇ Tuner operation	10-6
	◇ If the tuner cannot tune the antenna	10-7
Section 11	CLOCK AND TIMERS	
	■ Time set mode	11-2
	■ Daily timer setting	11-3
	■ Setting sleep timer	11-4
	■ Timer operation	11-4
Section 12	SET MODE	
	■ Set mode description	12-2
	◇ Set mode operation	12-2
	◇ Screen arrangement	12-3
	■ Level set mode	12-4
	■ ACC set mode	12-7
	■ Display set mode	12-9
	■ Others set mode	12-12
	■ USB-Memory set menu	12-19
	◇ USB-Memory set screen arrangement	12-19
	◇ Save option set mode	12-20
	◇ Load option set mode	12-21
	■ File saving	12-22
	■ File loading	12-23
	■ Changing a file name	12-24
	■ Deleting a file	12-25
	■ Unmounting USB-Memory	12-25
	■ Formatting the USB-Memory	12-26
Section 13	MAINTENANCE	
	■ Troubleshooting	13-2
	◇ Transceiver power	13-2
	◇ Transmit and receive	13-2
	◇ Scanning	13-3
	◇ Display	13-3
	◇ Format USB-Memory	13-3
	■ Main dial brake adjustment	13-3
	■ SWR reading	13-4
	■ Screen type and font selections	13-4
	■ Frequency calibration (approximate)	13-5
	■ Opening the transceiver's case	13-6
	■ Clock backup battery replacement	13-6

TABLE OF CONTENTS

	■ Fuse replacement	13-7
	■ Resetting the CPU	13-7
	■ About protection indications	13-8
	■ Screen saver function	13-8
Section 14	CONTROL COMMAND	
	■ Remote jack (CI-V) information	14-2
	◇ CI-V connection example	14-2
	◇ Data format	14-2
	◇ Command table	14-3
	◇ To send/read memory contents	14-9
	◇ Band stacking register	14-9
	◇ Codes for memory keyer contents	14-9
	◇ Codes for memory name, opening message and CLOCK2 name contents	14-9
	◇ Offset frequency setting	14-10
	◇ Repeater tone/tone squelch frequency setting	14-10
	◇ SSB transmission passband width setting	14-10
	◇ Color setting	14-10
	◇ Bandscope edge frequency setting	14-10
	◇ Data mode with filter width setting	14-10
	◇ Antenna memory setting	14-10
Section 15	SPECIFICATIONS AND OPTIONS	
	■ Specifications	15-2
	◇ General	15-2
	◇ Transmitter	15-2
	◇ Receiver	15-3
	◇ Antenna tuner	15-3
	■ Options	15-4
Section 16	UPDATING THE FIRMWARE	
	■ General	16-2
	■ Caution	16-2
	■ Preparation	16-3
	◇ Firmware and firm utility	16-3
	◇ File downloading	16-3
	■ Firmware update— USB-Memory	16-4
	■ Firmware update— PC	16-6
	◇ Connections	16-6
	◇ IP address setting	16-7
	◇ Updating from the PC	16-8

PANEL DESCRIPTION

Section 1

■ Front panel	1-2
■ Rear panel	1-12
■ LCD display	1-14
■ Screen menu arrangement	1-16

■ Front panel

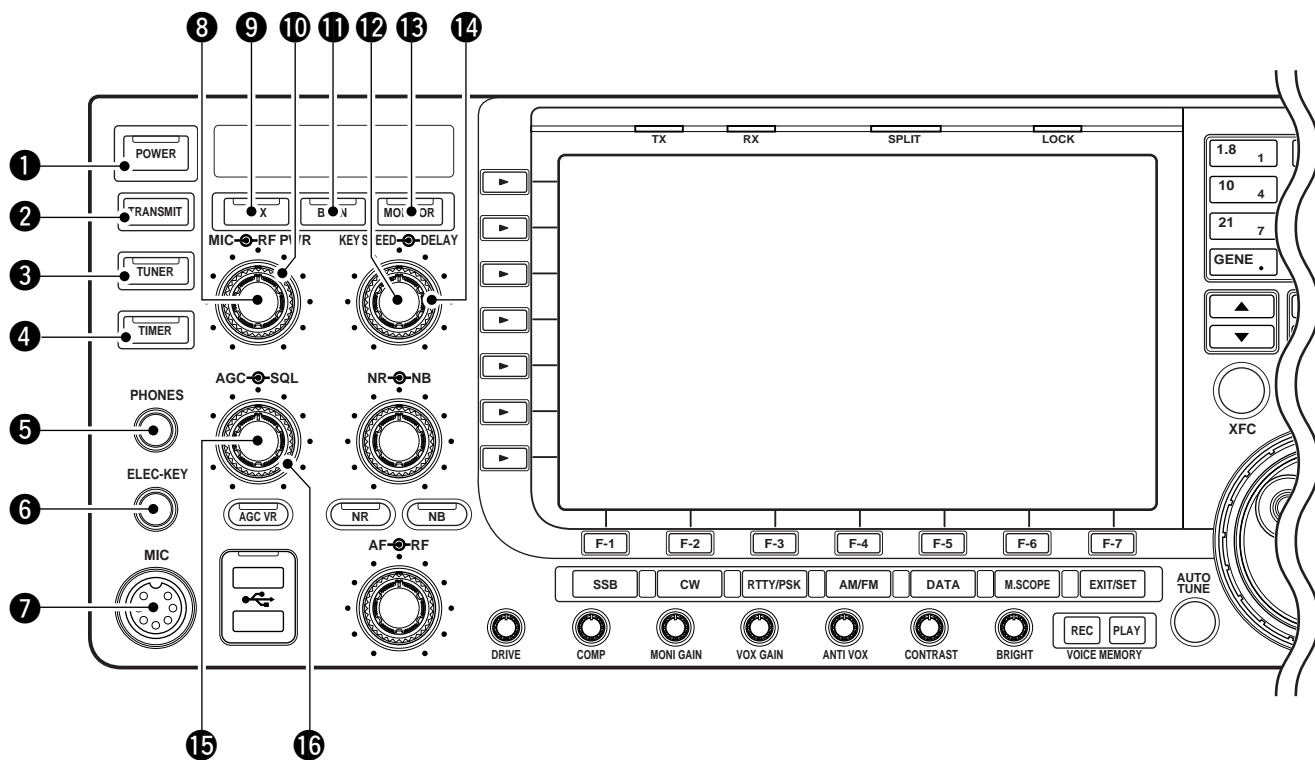

1 POWER SWITCH [POWER] (p. 3-2)

Turn the internal power supply ON in first. The internal power supply switch is located on the rear panel. (p. 3-2)

- Push to turn the transceiver power ON.
 - The [POWER] indicator above this switch lights green when powered ON.
- Push and hold for 1 sec. to turn the transceiver power OFF.
 - The [POWER] indicator lights orange when the transceiver is OFF when the internal power supply is switched ON.

2 TRANSMIT SWITCH [TRANSMIT]

Selects transmit or receive.

- The [TX] indicator lights red while transmitting and the [RX] indicator lights green when the squelch is open.

3 ANTENNA TUNER SWITCH [TUNER] (p. 10-6)

- Turns the internal antenna tuner ON and OFF (bypass) when pushed momentarily.
 - The [TUNER] indicator above this switch lights green when the tuner is turned ON, goes off when tuner is turned OFF (bypassed).
- Tunes the antenna tuner manually when pushed and held for 1 sec.
 - The [TUNER] indicator blinks red during manual tuning.
 - When the tuner cannot tune the antenna, the tuning circuit is bypassed automatically after 20 sec.

4 TIMER SWITCH [TIMER] (p. 11-4)

- Turns the sleep or daily timer function ON and OFF.
 - The [TIMER] indicator above this switch lights green when the timer is in use.
- Enters timer set mode when pushed and held for 1 sec.

5 HEADPHONE JACK [PHONES]

Accepts standard stereo headphones.

- Output power: 5 mW with an 8 Ω load.
- When headphones are connected, the internal speaker or connected external speaker does not function.

6 ELECTRONIC KEYS JACK [ELEC-KEY] (p. 2-5)

Accepts a paddle to activate the internal electronic keyer for CW operation.

- You can select internal electronic keyer, bug-key or straight key operation in keyer set mode. (p. 4-12)
- A straight key jack is located on the rear panel. See [CW KEY] on p. 1-12.
- Keyer polarity (dot and dash) can be reversed in keyer set mode. (p. 4-12)
- 4-channel memory keyer is available for your convenience. (p. 4-8)

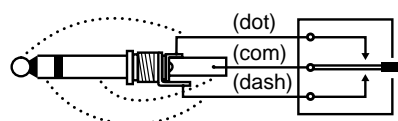

7 MICROPHONE CONNECTOR [MIC]

Accepts an optional microphone.
 • See p. 15-4 for appropriate microphones.
 • See p. 2-10 for microphone connector information.

8 MIC GAIN CONTROL [MIC] (p. 3-12)

Adjusts microphone input gain.
 • The transmit audio tone in SSB, AM and FM modes can be adjusted independently in set mode. (p. 12-5)

✓ How to set the microphone gain.

Set the [MIC] control so that the ALC meter occasionally moves up-scale during normal voice transmission in SSB, AM or FM mode.

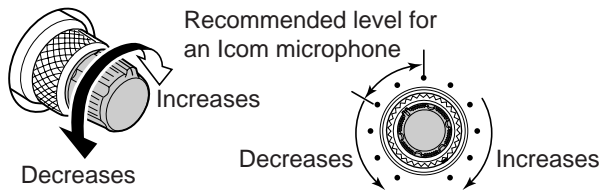

9 VOX SWITCH [VOX]

➔ Push to turn the VOX function ON and OFF during SSB, AM and FM mode operation. (p. 6-2)
 ➔ Push and hold for 1 sec. to enter VOX set mode. (p. 6-2)

✓ What is the VOX function?

The VOX function (voice operated transmission) activates transmission without pushing the transmit switch or PTT switch when you speak into the microphone; then automatically returns to receive when you stop speaking.

10 RF POWER CONTROL [RF PWR] (p. 3-12)

Continuously varies the RF output power from minimum (5 W*) to maximum (200 W*).
 *AM mode: 5 W to 50 W

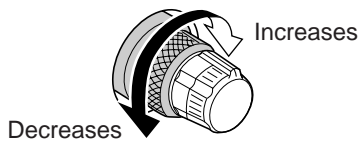

11 BREAK-IN SWITCH [BK-IN]

Push to turn the break-in function ON (semi-break-in, full-break-in) and OFF during CW mode operation. (p. 6-3)

✓ What is the break-in function?

The break-in function switches transmit and receive with CW keying. Full break-in (QSK) can monitor the receive signal between CW dots and dashes.

12 ELECTRONIC CW KEYSER SPEED CONTROL [KEY SPEED] (p. 4-4)

Adjusts the internal electronic CW keyer's speed.
 • 6 wpm (min.) to 48 wpm (max.) is the available range.

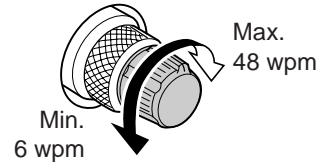

13 MONITOR SWITCH [MONITOR] (p. 6-4)

Monitors your transmitted IF signal.
 • The CW sidetone functions regardless of [MONITOR] switch setting in CW mode.
 • The [MONITOR] indicator above this switch lights green while the function is activated.

14 BREAK-IN DELAY CONTROL [DELAY] (p. 6-3)

Adjusts the transmit-to-receive switching delay time for CW semi-break-in operations.

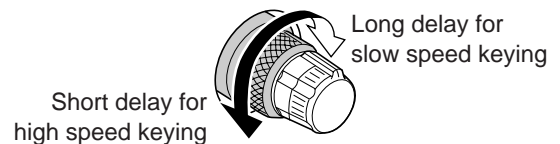

15 AGC CONTROL [AGC] (p. 5-11)

Adjusts the continuously-variable AGC circuit time constant.
 • To use [AGC] control, push [AGC VR] ([AGC VR] indicator lights).

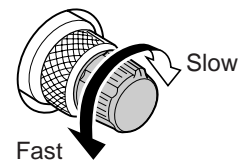

16 SQUELCH CONTROL [SQL]

(outer control; p. 3-9)
 Adjusts the squelch threshold level. The squelch mutes noise output from the speaker (closed condition) when no signal is received.
 • The squelch is particularly effective for FM. It is also available in other modes.
 • The 11 to 12 o'clock position is recommended for the most effective use of the [SQL] control.

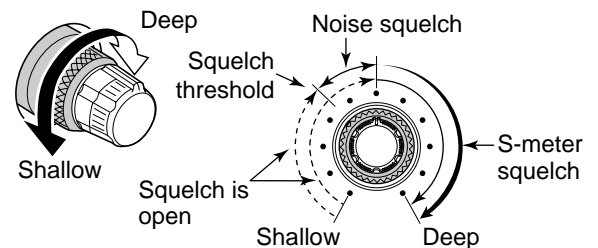

■ Front panel (continued)

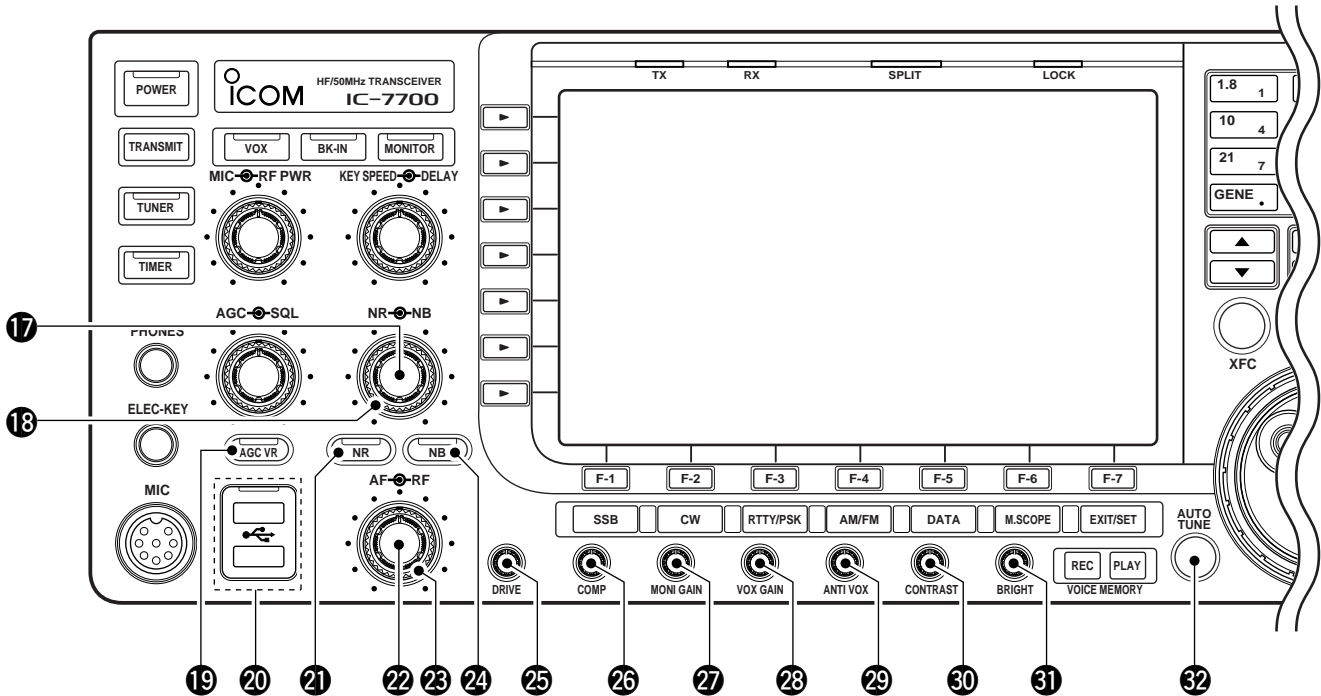

17 NOISE REDUCTION LEVEL CONTROL [NR]

(inner control; p. 5-17)
Adjusts the DSP noise reduction level when the noise reduction function is in use. Set for maximum readability.

- To use this control, push **NR**.

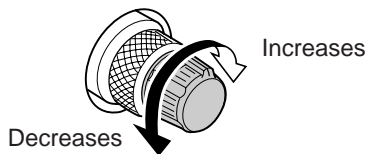

18 NOISE BLANKER CONTROL [NB]

(outer control; p. 5-16)
Adjust the noise blanker threshold level.

- To use this control, push **NB**.

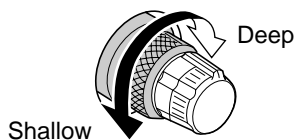

19 AGC VOLUME SWITCH [AGC VR] (p. 5-11)

- ➔ Push to toggle [AGC] control usage ON and OFF.
 - Use [AGC] control to set the AGC time constant when switched ON.
 - The [AGC VR] indicator above this switch lights green when the control is ON.
- ➔ Turns the AGC function OFF when pushed and held for 1 sec.

20 USB (Universal Serial Bus) CONNECTOR [USB] (p. 2-4)

- ➔ Insert USB-Memory* for both reading/storing a wide variety of the transceiver's information and data.
 - The indicator above the connectors lights or blinks when the transceiver reads or writes to the memory data.
 - Unmount operation is necessary before removing the USB-Memory* (p.12-25).
- ➔ Connects a PC keyboard for RTTY and PSK31 operations.
 - USB keyboard* is supported.

*: USB-Memory or USB keyboard is not supplied by Icom.

21 NOISE REDUCTION SWITCH [NR] (p. 5-17)

- ➔ Push to switch DSP noise reduction ON and OFF.
 - The [NR] indicator above this switch lights green when the function is activated.

22 AF CONTROL [AF] (inner control; p. 3-9)

Varies the audio output level of the speaker or headphones.

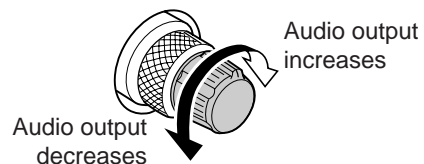

23 RF GAIN CONTROL [RF] (outer control; p. 3-9)

Adjusts the RF gain level.

While rotating the RF gain control, you may hear noise. This comes from the DSP unit and does not indicate a malfunction.

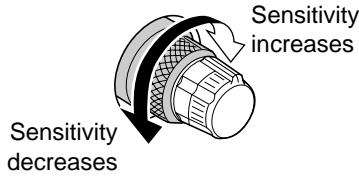

24 NOISE BLANKER SWITCH [NB] (p. 5-16)

Switches the noise blanker ON and OFF when pushed. The noise blanker reduces pulse-type noise such as that generated by automobile ignition systems. This function cannot be used in FM mode, or non-pulse-type noise.

- The [NB] indicator above this switch lights green while the function is activated.

Enters blanking-width set mode when pushed and held for 1 sec.

25 DRIVE GAIN CONTROL [DRIVE] (p. 3-13)

Adjusts the transmitter level at the driver stage. Active in all modes (other than SSB mode with [COMP] OFF).

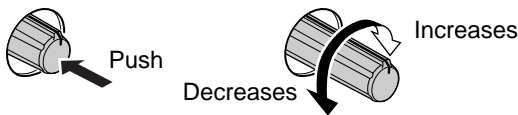

26 COMPRESSION LEVEL CONTROL [COMP] (p. 6-5)

Adjusts the speech compression level in SSB.

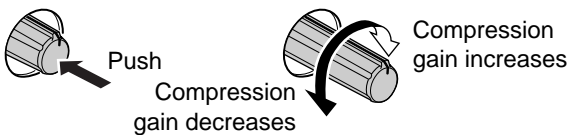

27 MONITOR GAIN CONTROL [MONI GAIN] (p. 6-4)

Adjusts the transmit IF signal monitor level.

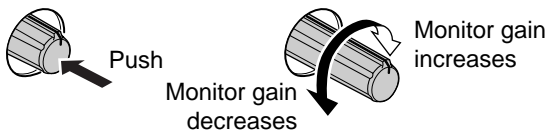

28 VOX GAIN CONTROL [VOX GAIN] (p. 6-2)

Adjusts the transmit/receive switching threshold level for VOX operation.

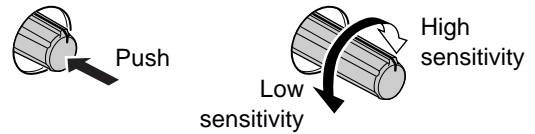

29 ANTI VOX CONTROL [ANTI VOX] (p. 6-2)

Adjusts the VOX sensitivity to speaker audio to prevent unwanted VOX activation.

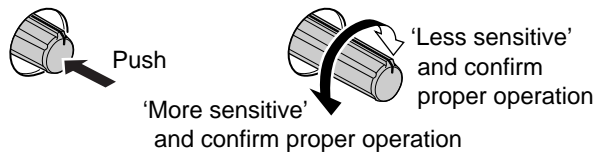

30 LCD CONTRAST CONTROL [CONTRAST]

Adjusts the LCD contrast.

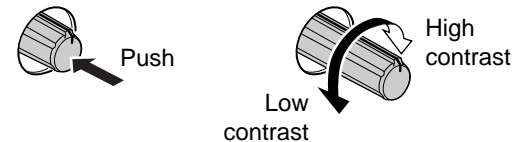

31 LCD BRIGHTNESS CONTROL [BRIGHT]

Adjusts the LCD brightness.



32 AUTOMATIC TUNING SWITCH [AUTOTUNE]

(p. 5-19)

Turns the automatic tuning function ON and OFF in CW and AM modes.

IMPORTANT!

When receiving a weak signal, or receiving a signal with interference, the automatic tuning function may tune the receiver to an undesired signal.

■ Front panel (continued)

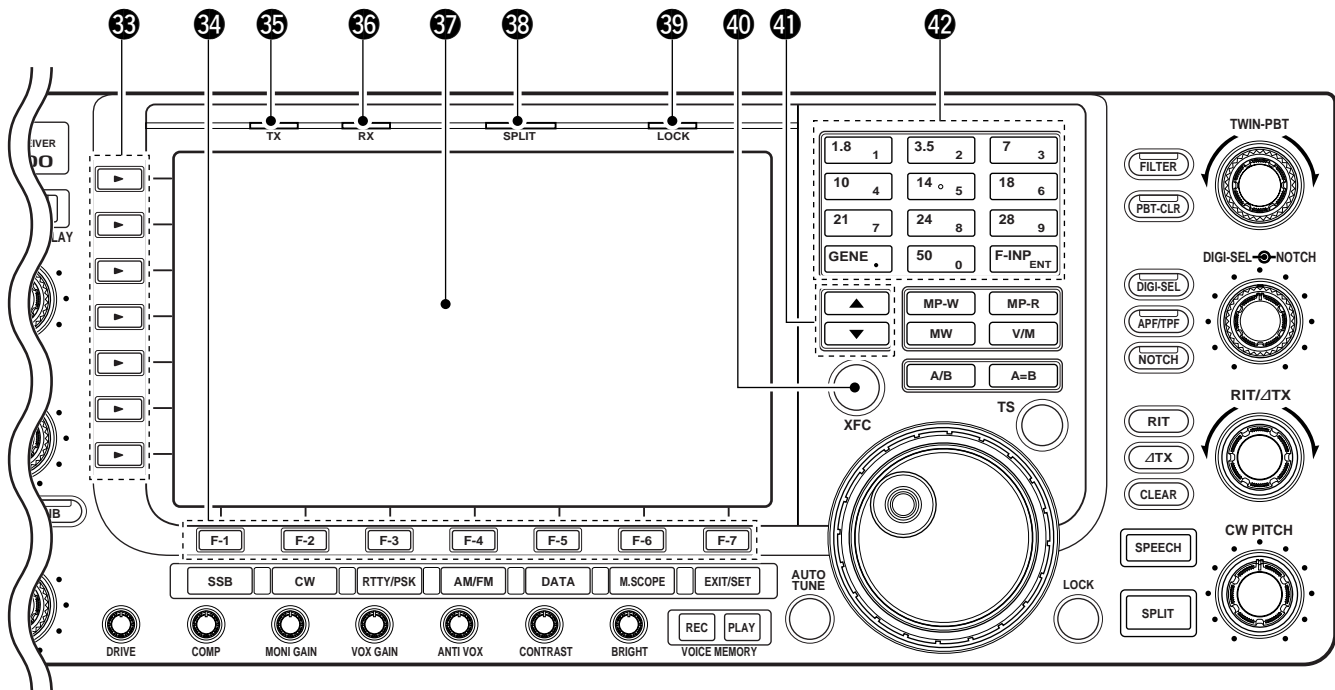

33 MULTI-FUNCTION SWITCHES

Push to select the functions indicated in the LCD display to the right of these switches.
 • Functions vary depending on the operating condition.

MF1 (MULTI-FUNCTION 1 SWITCH)

ANT 1 ➔ Selects the antenna connector from ANT1, ANT2, ANT3 and ANT4 when pushed. (p. 10-2)
 ➔ Displays antenna selection memory when pushed and held for 1 sec.
 • When the receive antenna is activated, the antenna connected to [ANT4] is used for receive only.
 // When a transverter is in use, this [ANT] does not function and 'TRV' appears.

MF2 (MULTI-FUNCTION 2 SWITCH)

METER Po ➔ Selects RF power (Po), SWR, ALC, COMP, Vd or Id metering during transmit. (p. 3-10)
 ➔ Switches the multi-function digital meter ON and OFF when pushed and held for 1 sec. (p. 3-10)

MF3 (MULTI-FUNCTION 3 SWITCH)

P.AMP 1 ➔ Selects one of 2 receive RF preamps or bypasses them. (p. 5-9)
 • "P. AMP1" activates 10 dB preamp.
 • "P. AMP2" activates 16 dB high-gain preamp.

✓ *What is the preamp?*

The preamp amplifies signals in the receiver front end to improve S/N ratio and sensitivity. Select "P. AMP1" or "P. AMP2" when receiving weak signals..

MF4 (MULTI-FUNCTION 4 SWITCH)

ATT OFF ➔ Selects 6 dB, 12 dB or 18 dB attenuator when pushed. (p. 5-9)
 ➔ Turns the attenuator function OFF when pushed and held for 1 sec. (p. 5-9)

✓ *What is the attenuator?*

The attenuator prevents a desired signal from being distorted when very strong signals are near the desired frequency, or when very strong electromagnetic fields, such as from a broadcasting station, are near your location.

MF5 (MULTI-FUNCTION 5 SWITCH)



- Activates and selects fast, mid-range or slow AGC time constant when pushed. (p. 5-11)
 - In FM mode, only “FAST” is available.
- Enters the AGC set mode when pushed and held for 1 sec. (p. 5-11)

AGC time constant can be set between 0.1 to 8.0 sec. (depends on mode), or turned OFF. When AGC is “OFF,” the S-meter does not function.

✓ **What is the AGC?**

The AGC controls receiver gain to produce a constant audio output level, even when the received signal strength varies dramatically. Select “FAST” for tuning and then select “MID” or “SLOW” depending on the receiving condition.

MF6 (MULTI-FUNCTION 6 SWITCH)



- Turns the speech compressor ON and OFF in SSB mode. (p. 6-5)
- Switches the narrow, middle or wide compression when pushed and held for 1 sec.

✓ **What is the speech compressor?**

The speech compressor compresses the transmitter audio input to increase the average audio output level, to increase talk power. This function is effective for long-distance communication or when propagation conditions are poor.



- Turns the 1/4-speed tuning function ON and OFF in SSB data, CW, RTTY and PSK modes. (p. 3-6)
 - 1/4 function sets dial rotation to 1/4 of normal speed for fine tuning.



- Switches between the tone encoder, tone squelch function and no-tone operation when pushed in FM mode. (pgs. 4-33, 4-34)
- Enters the tone set mode when pushed and held for 1 sec. in FM mode. (pgs. 4-33, 4-34)

MF7 (MULTI-FUNCTION 7 SWITCH)



- Switches the voice squelch control function ON and OFF; useful for scanning. (p. 9-3)

34 LCD FUNCTION SWITCHES [F-1]–[F-7]

Push to select the function indicated in the LCD display above these switches.

- Functions vary depending on the operating condition.

35 TRANSMIT INDICATOR [TX]

Lights red while transmitting.

36 RECEIVE INDICATOR [RX]

Lights green while receiving a signal and when the squelch is open.

37 LCD FUNCTION DISPLAY (p. 1-14)

Shows the operating frequency, function switch menus, spectrum scope screen, memory list screen, set mode settings, etc.

38 SPLIT OPERATION INDICATOR [SPLIT]

Lights during split frequency operation.

39 LOCK INDICATOR [LOCK] (p. 5-17)

Lights when the dial lock function is activated.

40 TRANSMIT FREQUENCY CHECK SWITCH [XFC] (p. 6-6)

Monitors the transmit frequency (including ΔTX frequency offset) when pushed and held during split frequency operation.

- While pushing this switch, the transmit frequency can be changed with the main dial, keypad, memo pad or ▲ / ▼ switches.
- When the split lock function is turned ON, pushing [XFC] cancels the dial lock function. (p. 6-7)

41 MEMORY UP/DOWN SWITCHES ▲ / ▼ (p. 8-2)

Push to select the desired memory channel.

- Memory channels can be selected both in VFO and memory modes.

42 KEYPAD

- Pushing a key selects the operating band. (p. 3-4)
 - [GENE] selects the general coverage band.
- Pushing the same key 2 or 3 times calls up other stacked frequencies in the band. (p. 3-4)
 - Icom’s triple band stacking register memorizes 3 frequencies in each band.
- After pushing [F-INP ENT], enters a frequency or memory channel. Pushing [F-INP ENT] or ▲ / ▼ is necessary to end the entry. (pgs. 3-5, 8-2)
 - e.g. to enter 14.195 MHz, push [F-INP ENT] [1.8] [1] [4] [9] [5] [F-INP ENT].

■ Front panel (continued)

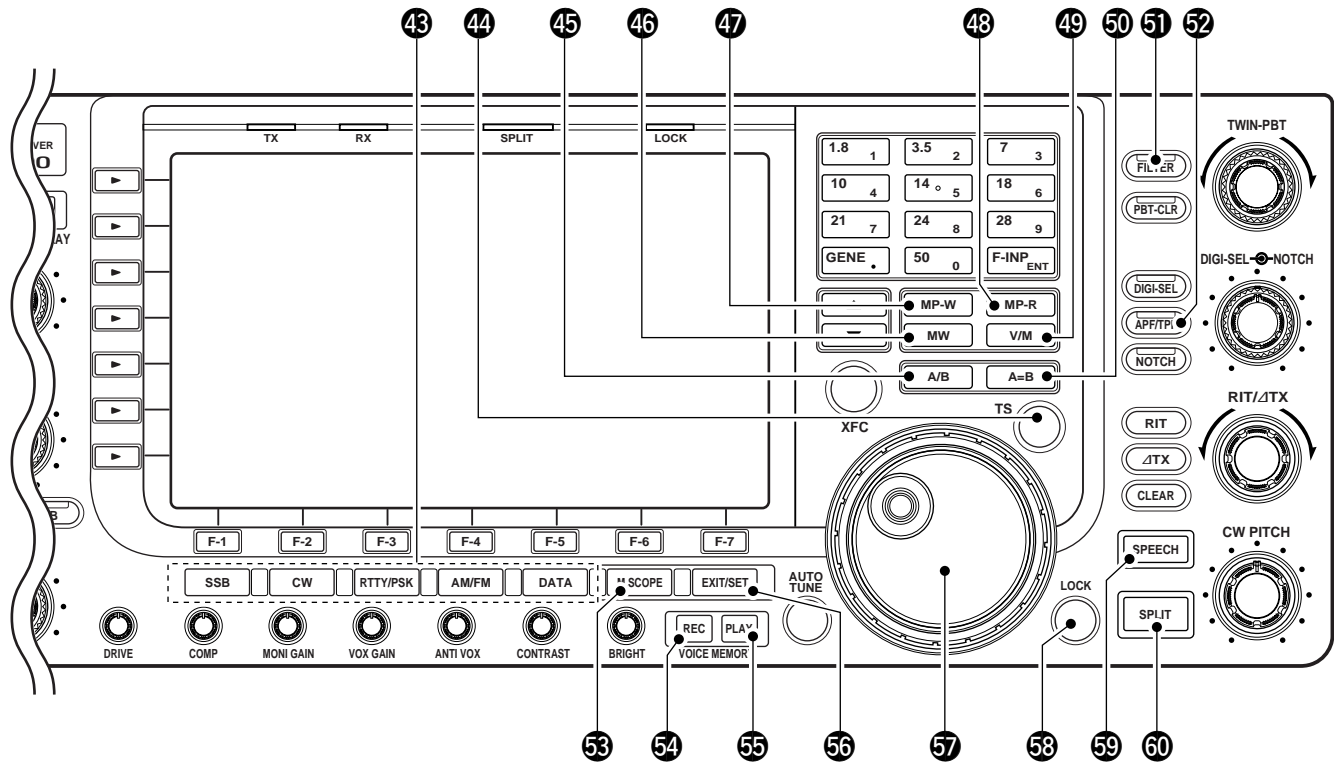

43 MODE SWITCHES

Selects the desired mode. (p. 3-8)
 • Announces selected mode via the speech synthesizer. (p. 12-15)

SSB Selects USB and LSB modes alternately.

CW Selects CW and CW-R (CW reverse) modes alternately.

RTTY/PSK ➔ Switches between RTTY and PSK mode.
 ➔ Switches RTTY and RTTY-R (RTTY reverse) mode when pushed and held for 1 sec. in RTTY mode.
 ➔ Switches PSK and PSK-R (PSK reverse) mode when pushed and held for 1 sec. in PSK mode.

AM/FM Selects AM and FM modes alternately.

DATA ➔ Selects SSB, AM or FM data mode (USB-D, LSB-D, AM-D, FM-D) when pushed in SSB, AM or FM mode, respectively.
 ➔ Switches D1, D2 and D3 when pushed and held for 1 sec.

44 QUICK TUNING SWITCH [TS]

- ➔ Turns the quick tuning step ON and OFF. (p. 3-6)
 - While the quick tuning indicator, “▼”, is displayed above the frequency indication, the frequency can be changed in programmed kHz steps.
 - 0.1, 1, 5, 9, 10, 12.5, 20 and 25 kHz steps are available for each operating mode independently.
- ➔ When the quick tuning step is OFF, push and hold for 1 sec. to turn the 1 Hz tuning step ON and OFF. (p. 3-7)
- ➔ When the quick tuning step is ON, push and hold for 1 sec. to enter quick tuning step set mode. (p. 3-6)

45 VFO SELECT SWITCH A/B

Switches the selected VFO between the VFO-A and VFO-B when pushed.
 • Switches between transmit frequency and receive frequency when the split frequency function is ON. (p. 6-6)

46 MEMORY WRITE SWITCH MW (p. 8-3)

Stores the selected readout frequency and operating mode into the displayed memory channel when pushed and held for 1 sec.
 • This function is available both in VFO and memory modes.

- 47 MEMO PAD-WRITE SWITCH** MP-W (p. 8-7)
 Programs the displayed readout frequency and operating mode into a memo pad.
 • The 5 most recent entries remain in memo pads.
 • The memo pad capacity can be expanded from 5 to 10 in set mode. (p. 12-15)
- 48 MEMO PAD-READ SWITCH** MP-R (p. 8-7)
 Each push calls up a frequency and operating mode in a memo pad. The 5 (or 10) most recently programmed frequencies and operating modes can be recalled, starting from the most recent.
 • The memo pad capacity can be expanded from 5 to 10 in set mode. (p. 12-15)
- 49 VFO/MEMORY SWITCH** V/M
 ➔ Switches the selected readout operating mode between the VFO and memory when pushed. (pgs. 3-3, 8-2)
 ➔ Transfers the memory contents to VFO when pushed and held for 1 sec. (p. 8-4)
- 50 VFO EQUALIZING SWITCH** A=B (p. 3-3)
 Transfers the undisplayed VFO frequency to the displayed VFO frequency when pushed and held for 1 sec.
- 51 FILTER SWITCH** FILTER (p. 5-13)
 ➔ Selects one of 3 IF filter settings.
 ➔ Enters the filter set screen when pushed and held for 1 sec.
- 52 AUDIO PEAK FILTER/TWIN PEAK FILTER SWITCH** APF/TPF
 ➔ Push to turn the audio peak filter ON and OFF during CW mode operation. (p. 4-6)
 • “APF” appears when audio peak filter is in use.
 ➔ Push to turn the twin peak filter ON and OFF during RTTY mode operation. (p. 4-14)
 • “TPF” appears when twin peak filter is in use.
 ➔ During CW mode operation, push and hold for 1 sec. to select the APF passband width from 320, 160 and 80 Hz. (p. 4-6)
- 53 MINI SPECTRUM SCOPE SWITCH** M.SCOPE (p. 5-4)
 ➔ Turns the mini spectrum scope screen ON and OFF when pushed.
 • The mini spectrum scope screen can be displayed with another screen, such as memory or set mode screen, simultaneously.
 ➔ Turns the spectrum scope screen ON when pushed and held for 1 sec.
- 54 VOICE MEMORY RECORD SWITCH** REC (p. 7-3)
 ➔ Push to record the received signal for the preset time period.
 • After the preset time has passed, stops recording automatically.
 ➔ Push and hold for 1 sec. to record the received signal until the recording is canceled.
 • Push this switch momentarily to stop recording.
 • The memory records the latest 30 sec. of audio.
- 55 VOICE MEMORY PLAYBACK SWITCH** PLAY (p. 7-4)
 ➔ Plays back the previously recorded audio for the preset time period when pushed.
 ➔ Plays back all of the previously recorded audio when pushed and held for 1 sec.
- 56 EXIT/SET SWITCH** EXIT/SET
 ➔ Push to exit, or return to the previous screen indication during spectrum scope, memory, scan or set mode screen display.
 ➔ Displays set mode menu screen when pushed and held for 1 sec.
- 57 MAIN DIAL**
 Changes the displayed frequency, selects set mode setting, etc.
- 58 LOCK SWITCH** [LOCK] (p. 5-17)
 Push to switch the dial lock function ON and OFF.
- 59 SPEECH SWITCH** SPEECH (p. 3-11)
 ➔ Push to announce the S-meter indication and the selected frequency.
 ➔ The selected operating mode is additionally announced when pushed and held for 1 sec.
- 60 SPLIT SWITCH** SPLIT (p. 6-6)
 ➔ Turns the split function ON and OFF when pushed.
 ➔ Turns the split function ON. When pushed and held for 1 sec. in non-FM modes, transfers the unselected VFO's readout frequency to the selected VFO's readout and sets the unselected VFO to transmit VFO. (Quick split function)
 • The offset frequency is shifted from the selected VFO frequency in FM mode. (p. 12-13)
 • The quick split function can be turned OFF using set mode. (p. 12-12)
 ➔ Turns the split function ON and shifts the unselected VFO frequency after inputting an offset.

■ Front panel (continued)

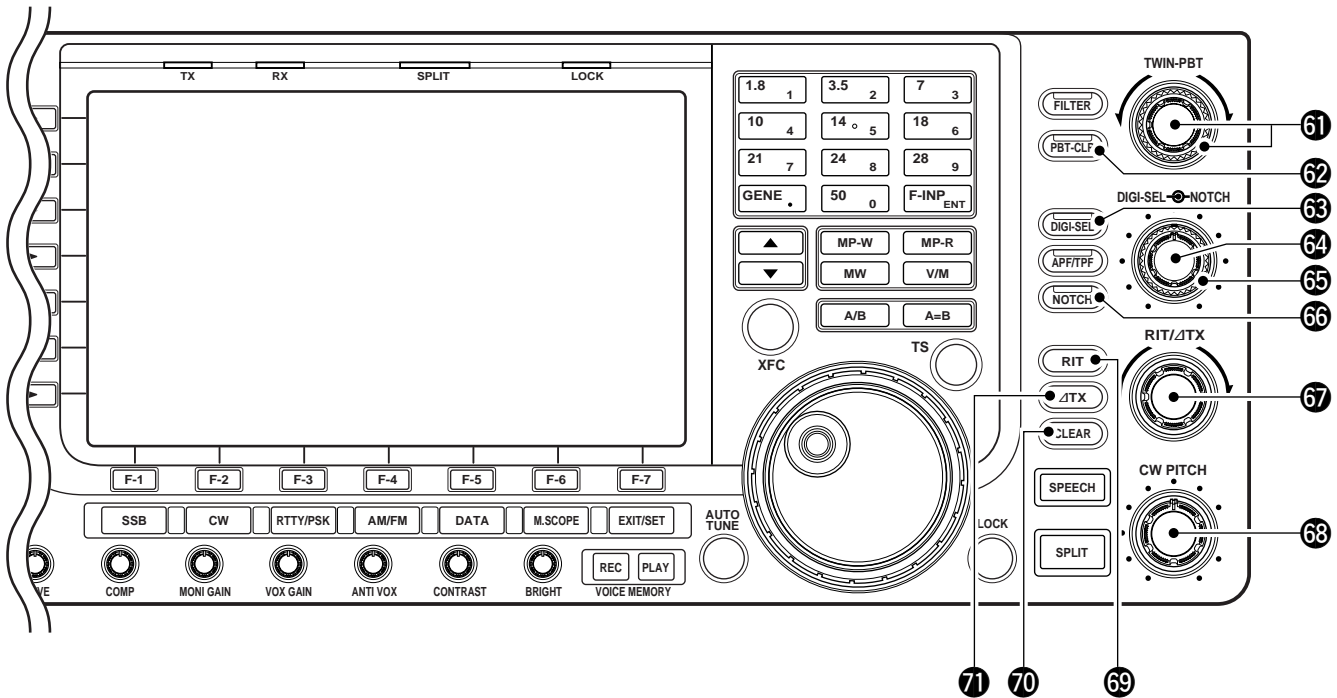

61 PASSBAND TUNING CONTROLS [TWIN-PBT]

(p. 5-12)

Adjusts the receiver's IF filter "passband width" via the DSP.

- Passband width and shift frequency are displayed in the multi-function display.
- Push and hold [PBT-CLR] for 1 sec. to clear the PBT settings.
- Adjustment range is set to half of the IF filter passband width. 25 Hz steps and 50 Hz steps are available.

✓ What is the PBT control?

The PBT function electronically modifies the IF passband width to reject interference. This transceiver uses the DSP circuit for the PBT function.

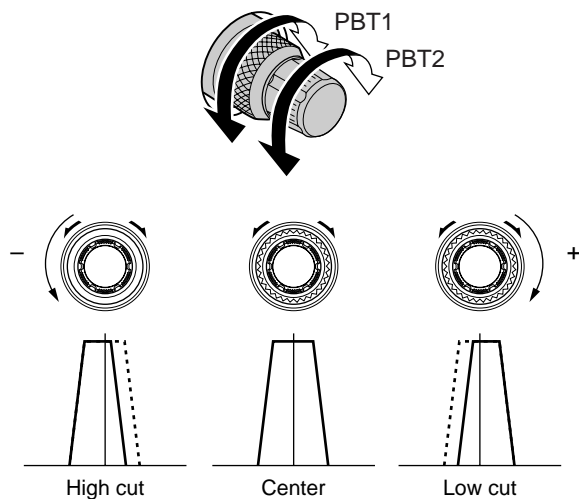

62 PBT CLEAR SWITCH [PBT-CLR] (p. 5-12)

Clears the PBT settings when pushed and held for 1 sec.

- The [PBT-CLR] indicator above this switch lights when PBT is in use.

63 DIGITAL RF SELECTOR SWITCH [DIGI-SEL]

(p. 5-18)

Turns the digital RF preselector ON and OFF.

- The [DIGI-SEL] indicator lights green when the preselector is in use.

64 DIGITAL RF SELECTOR CONTROL [DIGI-SEL]

(p. 5-18)

Adjusts the digital RF selector center frequency.

- The control can be reassigned as the audio peak filter adjustment (p. 12-16)

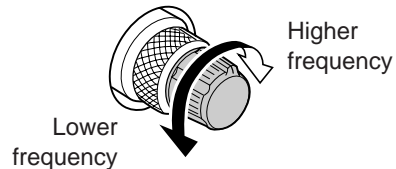

65 MANUAL NOTCH FILTER CONTROL [NOTCH]

(outer control; p. 5-18)

Varies the “valley” frequency of the manual notch filter to reject an interfering signal while the manual notch function is ON.

- Notch filter center frequency:
 - SSB : -1060 Hz to 4040 Hz
 - CW : CW pitch freq. + 2540 Hz to CW pitch freq. -2540 Hz
 - AM : -5100 Hz to 5100 Hz

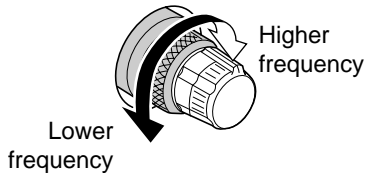

66 NOTCH SWITCH [NOTCH] (p. 5-18)

- ➔ Switches the notch function between auto, manual and OFF in SSB and AM modes.
- ➔ Turns the manual notch function ON and OFF when pushed in CW, RTTY and PSK31 mode.
- ➔ Turns the auto notch function ON and OFF when pushed in FM mode.
 - “MN” appears when manual notch is in use.
 - “AN” appears when auto notch is in use.
- ➔ Switches the manual notch characteristics from wide, middle and narrow when pushed and held for 1 sec.

✓ **What is the notch function?**

The notch function is a narrow filter that eliminates unwanted CW or AM carrier tones while preserving the desired voice signal. The DSP circuit automatically adjusts the filtering frequency to effectively eliminate unwanted tones.

67 RIT/ΔTX CONTROL [RIT/ΔTX] (pgs. 5-10, 6-4)

Shifts the receive and/or transmit frequency without changing the transmit and/or receive frequency shown on the main VFO.

- Rotate the control clockwise to increase the frequency, or rotate the control counterclockwise to decrease the frequency. The RIT or ΔTX functions must be ON.

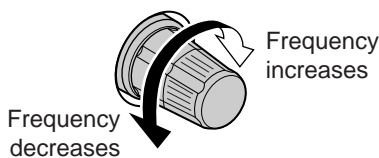

- The shift frequency range is ±9.999 kHz in 1 Hz steps (or ±9.99 kHz in 10 Hz steps).

68 CW PITCH CONTROL [CW PITCH] (p. 4-5)

Shifts the received CW audio pitch and the CW side tone pitch without changing the operating frequency.

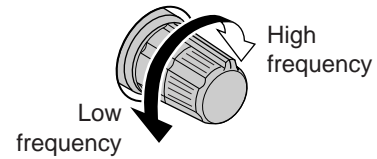

69 RIT SWITCH [RIT] (p. 5-10)

- ➔ Turns the RIT function ON and OFF when pushed.
 - Use [RIT/ΔTX] control to vary the RIT frequency.
- ➔ Adds the RIT shift frequency to the operating frequency when pushed and held for 1 sec.

✓ **What is the RIT function?**

Receiver incremental tuning (RIT) shifts the receive frequency without shifting the transmit frequency.

This is useful for fine tuning stations calling you off-frequency or when you prefer to listen to slightly different-sounding voice characteristics, etc.

70 CLEAR SWITCH [CLEAR] (pgs. 5-10, 6-4)

- ➔ Clears the RIT/ΔTX shift frequency when pushed and held for 1 sec. or when pushed momentarily, depending on the quick RIT/ΔTX clear function setting (p. 12-15).

71 ΔTX SWITCH [ΔTX] (p. 6-4)

- ➔ Turns the ΔTX function ON and OFF when pushed.
 - Use [RIT/ΔTX] control to vary the ΔTX frequency.
- ➔ Adds the ΔTX shift frequency to the operating frequency when pushed and held for 1 sec.

✓ **What is the ΔTX function?**

ΔTX shifts the transmit frequency without shifting the receive frequency. This is useful for simple split frequency operation in CW, etc.

■ Rear panel

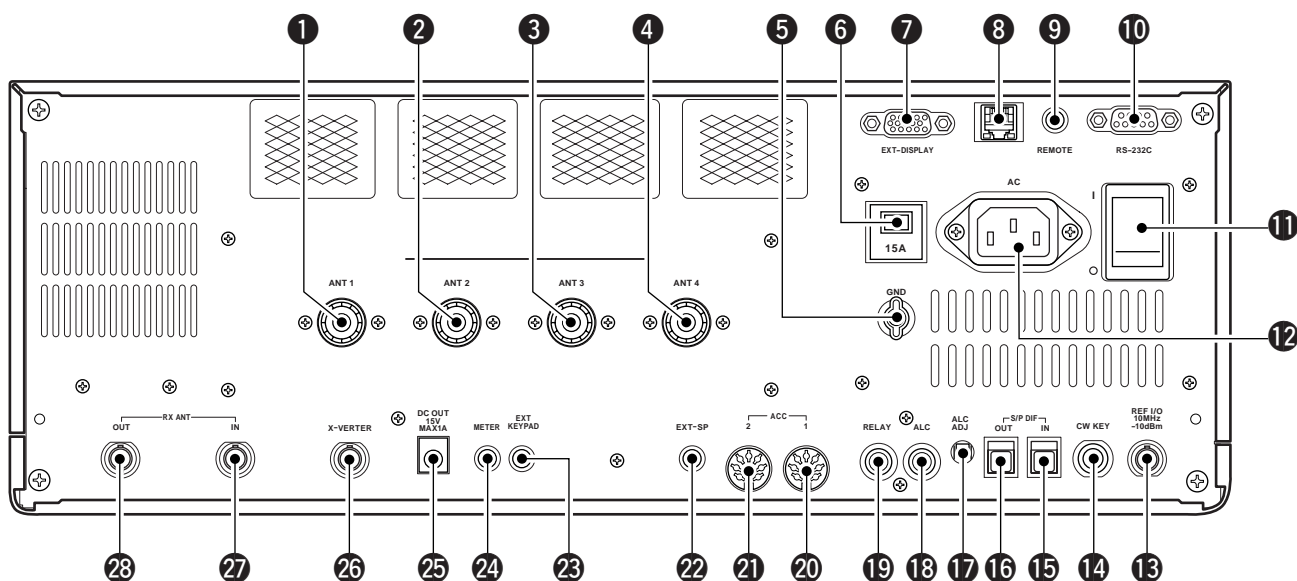

- 1 ANTENNA CONNECTOR 1 [ANT 1]** (p. 2-5)
- 2 ANTENNA CONNECTOR 2 [ANT 2]** (p. 2-5)
- 3 ANTENNA CONNECTOR 3 [ANT 3]** (p. 2-5)
- 4 ANTENNA CONNECTOR 4 [ANT 4]** (p. 2-5)
Accept a 50 Ω antenna with a PL-259 plug connector.
- 5 GROUND TERMINAL [GND]** (p. 2-4)
Connect this terminal to a ground to prevent electrical shocks, TVI, BCI and other problems.
- 6 CIRCUIT BREAKER**
Cuts off the AC input when over-current occurs.
- 7 EXTERNAL DISPLAY TERMINAL [EXT-DISPLAY]** (p. 2-7)
Connects to an external display monitor.
• At least 800×600 pixel display is necessary.
- 8 ETHERNET CONNECTOR** (p. 16-6)
Connects to a PC through a LAN (Local Area Network).
- 9 CI-V REMOTE CONTROL JACK [REMOTE]** (pgs. 2-6, 14-2)
➤ Connects a PC via the optional CT-17 CI-V LEVEL CONVERTER for external control of the transceiver.
➤ Used for transceiver operation with another Icom CI-V transceiver or receiver.

- 10 RS-232C TERMINAL [RS-232C]** (p. 2-6)
Connects an RS-232C cable, D-sub 9-pin to connect the IC-7700 to a PC.
Can be used to remotely control the IC-7700 without the optional CT-17, or for RTTY/PSK31 decoded signal output. The [RS-232C] interface is wired as a modem (DCE).
- 11 MAIN POWER SWITCH [I/O]** (p. 3-2)
Turns the internal power supply ON and OFF.
- 12 AC POWER SOCKET [AC]** (p. 2-5)
Connects the supplied AC power cable to an AC line-voltage receptacle.
- 13 REFERENCE SIGNAL INPUT/OUTPUT TERMINAL [REF I/O]**
Inputs/outputs a 10 MHz reference signal.
- 14 STRAIGHT KEY JACK [CW KEY]** (p. 2-5)
Accepts a straight key or external electronic keyer with ¼ inch standard plug.
• [ELEC-KEY] on the front panel can be used for a straight key or external electronic keyer. Deactivate the internal electronic keyer in keyer set mode. (p. 4-12)

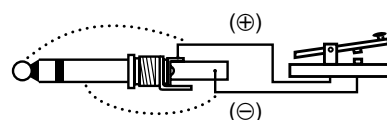

15 S/P DIF INPUT TERMINAL [S/P DIF- IN] (p. 2-7)

16 S/P DIF OUTPUT TERMINAL [S/P DIF- OUT]
(p. 2-7)

Connects external equipment that supports S/P DIF input/output.

17 ALC LEVEL ADJUSTMENT POT [ALC ADJ]

Adjusts the ALC levels.

No adjustment is required when the ALC output level of a connected non-Icom linear amplifier is 0 to -4 V a DC.

18 ALC INPUT JACK [ALC] (p. 2-8)

Connects to the ALC output jack of a non-Icom linear amplifier.

19 T/R CONTROL JACK [RELAY] (p. 2-8)

Connects to ground when transmitting to control an external unit, such as a non-Icom linear amplifier.

NOTE: T/R control voltage and current must be lower than 16 V DC/0.5 A (or 250 V AC, 200 mA with MOSFET switching).

20 ACCESSORY SOCKET 1 [ACC 1]

21 ACCESSORY SOCKET 2 [ACC 2]

Enable connection of external equipment such as a linear amplifier, an automatic antenna selector/tuner, a TNC for data communications, etc.

- See p. 2-11 for socket information.

22 EXTERNAL SPEAKER JACK [EXT-SP] (p. 2-6)

Connects an external speaker (4–8 Ω), if desired.

23 EXTERNAL KEYPAD JACK [EXT KEYPAD]

(p. 2-7)

Connects an external keypad for direct voice memory or electronic keyer control.

Transceiver mute control line (both transmit and receive) is also supported.

24 METER JACK [METER] (p. 2-7)

Outputs a signal showing received signal strength, transmit output power, VSWR, ALC, speech compression, V_D or I_D level for external meter indication.

25 DC OUTPUT JACK [DC OUT] (p. 2-7)

Outputs a regulated 14 V DC (approx.) for external equipment. Connected in parallel with 13.8 V outputs of [ACC 1] and [ACC 2]. (max. 1 A in total)

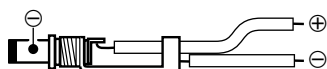

26 TRANSVERTER CONNECTOR [X-VERTER]

(p. 2-6)

External transverter input/output connector.

Activated by voltage applied to [ACC 2] pin 6, or when the transverter function is in use. (pgs. 2-11)

27 RECEIVE ANTENNA IN [RX ANT- IN]

28 RECEIVE ANTENNA OUT [RX ANT- OUT]

Located between the transmit/receive switching circuit and receiver's RF stage.

Connects an external unit, such as preamplifier or RF filter, using BNC connectors, if desired.

When no external unit is connected, [RX ANT- IN] and [RX ANT- OUT] must be deactivated and shorted by the switching relay internally. This setting is available on the antenna set screen. (p. 10-5)

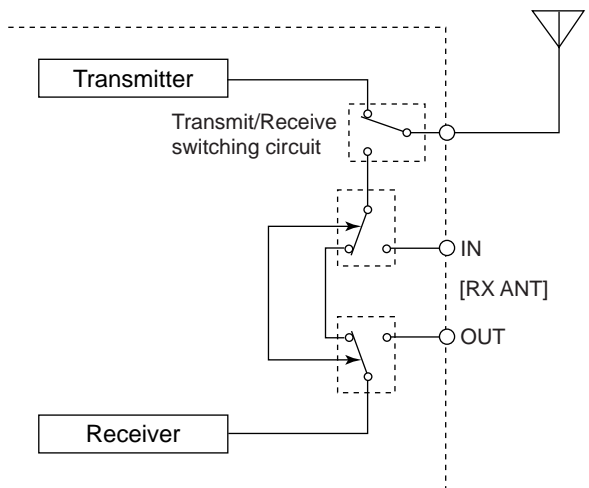

1 PANEL DESCRIPTION

■ LCD display

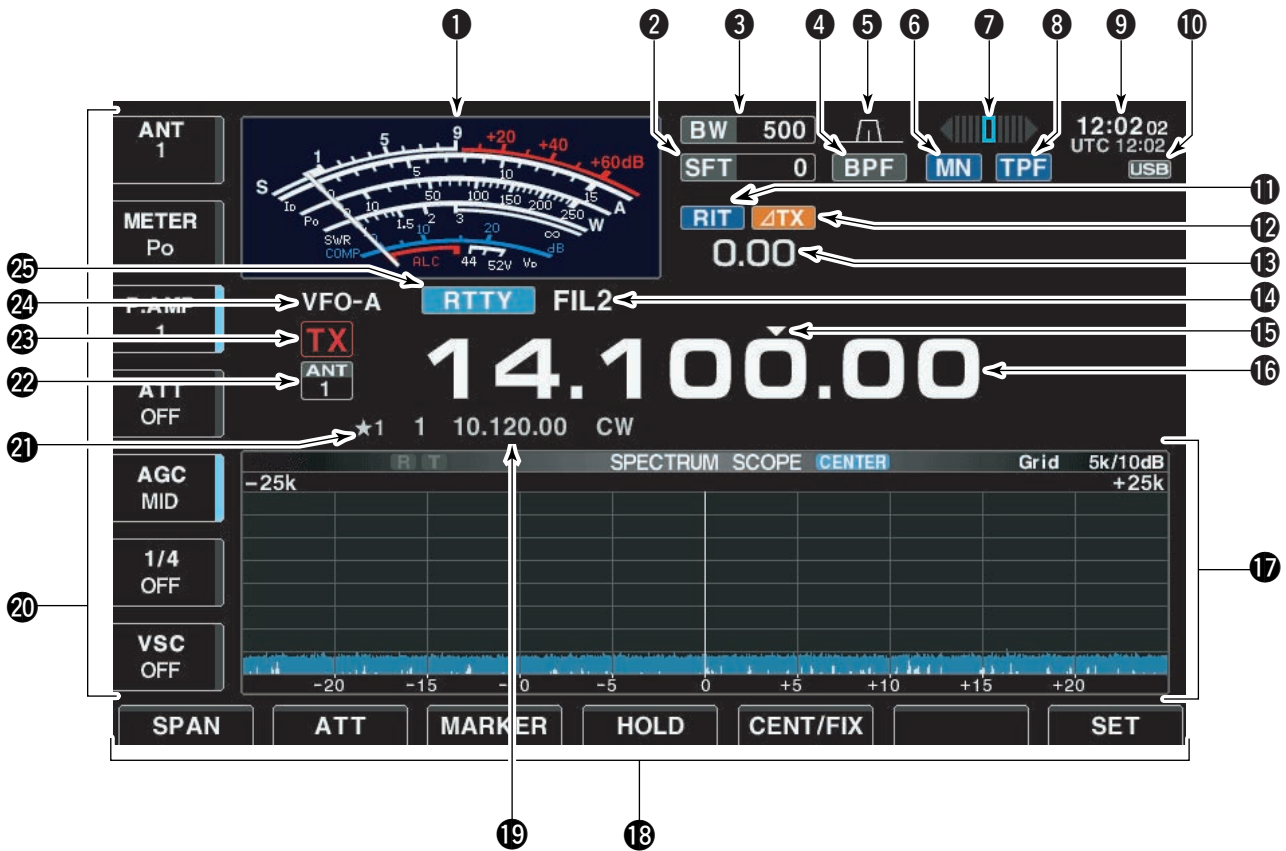

1 S/R/F METER (pgs. 3-10, 3-11)

Shows the signal strength while receiving. Shows the relative output power, SWR, ALC or compression levels while transmitting.

- A total of 3 meter types are available.

- Standard meter



- Edgewise meter

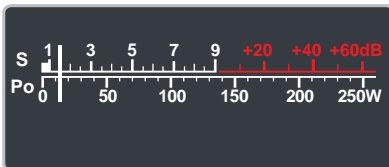

- Bar meter

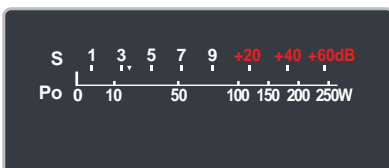

2 SHIFT FREQUENCY INDICATOR (p. 5-12)

Shows the shift frequency of the IF filter.

3 BAND WIDTH INDICATOR (p. 5-12)

Shows the passband width of the IF filter.

4 BANDPASS FILTER INDICATOR

Appears when the narrow filter (500 Hz or less) is selected during CW, RTTY or PSK31 operation.

5 PASSBAND WIDTH INDICATOR (p. 5-12)

Graphically displays the passband width for twin PBT operation and center frequency for IF shift operation.

6 NOTCH INDICATOR (p. 5-18)

➔ “**MN**” appears when the manual notch function is in use. This function is available in SSB, CW, RTTY, PSK and AM modes.

➔ “**AN**” appears when the auto notch function is in use. This function is available in SSB, AM and FM modes.

7 RTTY TUNING INDICATOR

Shows the tuning condition in RTTY mode.

8 APF/TPF INDICATOR

- ➔ “**APF**” appears when the audio peak filter function is in use. This function is available in CW mode. (p. 4-6)
- ➔ “**TPF**” appears when the twin peak filter function is in use. This function is available in RTTY mode. (p. 4-14)

9 CLOCK READOUT

Shows the current time. Local and UTC time can be indicated at the same time.

10 USB-MEMORY INDICATOR

Appears when USB-Memory is connected and blinks while reading or writing the USB-Memory.

11 RIT INDICATOR

Appears when RIT function is in use.

12 ΔTX INDICATOR

Appears when ΔTX function is in use.

13 RIT/ΔTX SHIFT FREQUENCY INDICATOR

Shows the shift frequency for the RIT or ΔTX function.

14 IF FILTER INDICATOR (p. 5-13)

Shows the selected IF filter number.

15 QUICK TUNING INDICATOR (p. 3-6)

Appears when the quick tuning step function is in use.

16 FREQUENCY READOUTS

Shows the operating frequency.

17 MULTI-FUNCTION SCREEN

Shows the screens for the multi-function digital meter, spectrum scope, voice recorder, memory list, scan, memory keyer, RTTY decoder, PSK decoder, IF filter selection or set modes, etc.

18 LCD FUNCTION SWITCH GUIDE

Indicates the function of the LCD function switches ([F-1] – [F-7]).

19 MEMORY CHANNEL READOUTS

- ➔ Shows the selected memory channel contents in VFO mode.
- ➔ Shows the VFO contents in memory mode.

20 MULTI-FUNCTION SWITCH GUIDE

Indicates the function of the multi-function switches.

21 SELECT MEMORY CHANNEL INDICATOR (p. 9-7)

Indicates the displayed memory channel is set as a select memory channel.

22 SELECT ANTENNA INDICATOR

Indicates the selected antenna.

23 TX INDICATOR

Indicates the frequency readout for transmit.

24 VFO/MEMORY CHANNEL INDICATOR (p. 3-3)

Indicates the VFO mode or selected memory channel number.

25 MODE INDICATOR

Shows the selected mode.

■ Screen menu arrangement

The following screens can be selected from the start up screen. Choose the desired screen using the following chart.

Pushing **[EXIT/SET]** several times returns to the start up screen. See p. 12-3 for set mode arrangement.



• PSK31 decoder screen (PSK mode; p. 4-21)



• Spectrum scope screen (p. 5-2)

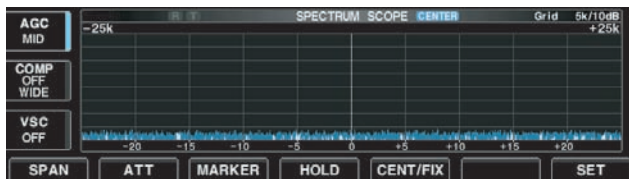

• Memory list screen (p. 8-5)



• Voice recorder screen (p. 7-3)

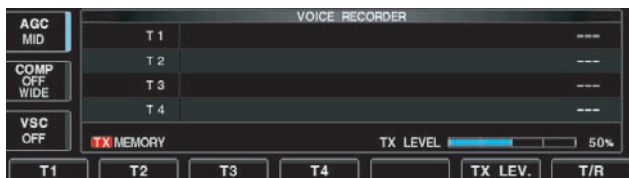

• Scan screen (VFO mode; p. 9-4)

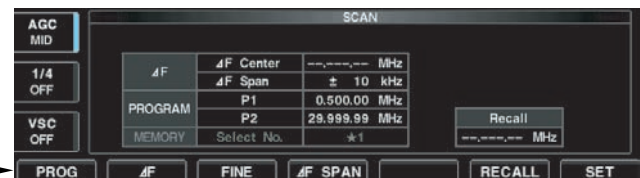

• Memory keyer screen (CW mode; p. 4-8)



• Scan screen (Memory mode; p. 9-6)

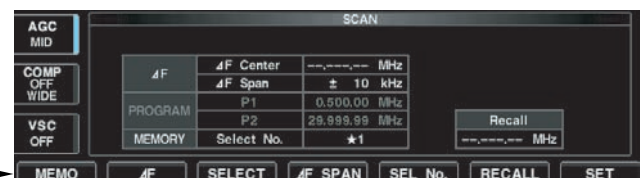

• RTTY decoder screen (RTTY mode; p. 4-13)

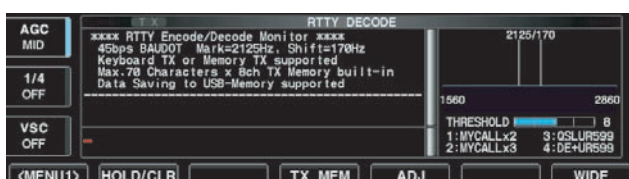

• Set mode menu screen (p. 12-2)

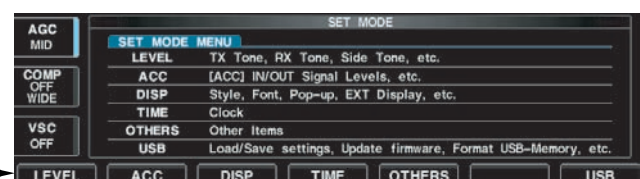

- Unpacking 2-2
- Main dial attachment 2-2
- Rack mounting handle detachment 2-3
- Selecting a location 2-3
- Grounding 2-4
- Antenna connection 2-4
- USB-Memory connection 2-4
- Required connections 2-5
 - ◇ Front panel 2-5
 - ◇ Rear panel 2-5
- Advanced connections 2-6
 - ◇ Front panel 2-6
 - ◇ Rear panel—1 2-6
 - ◇ Rear panel—2 2-7
- Linear amplifier connections 2-8
 - ◇ Connecting the IC-PW1/EURO 2-8
 - ◇ Connecting a non-Icom linear amplifier 2-8
- Transverter jack information 2-9
- FSK and AFSK (SSTV) connections 2-9
- Microphone connector information 2-10
- Microphones (options) 2-10
 - ◇ SM-20 2-10
 - ◇ HM-36 2-10
- Accessory connector information 2-11



CAUTION!: The transceiver weighs approx. 24 kg (53 lb).
Always have two people available to carry, lift or
turn over the transceiver.

■ Unpacking

After unpacking, immediately report any damage to the delivering carrier or dealer. Keep the shipping cartons.

For a description and a diagram of accessory equipment included with the IC-7700, see 'Supplied accessories' on p. iii of this manual.

■ Main dial attachment

The main dial is shipped unattached to the transceiver to prevent possible damage to the dial shaft or rotary encoder during shipping. Please attach the dial as described below.

⚠ CAUTION!: NEVER hold any controller knob(s), such as the main dial, when carrying or lifting the transceiver. This will damage the dial shaft or rotary encoder.

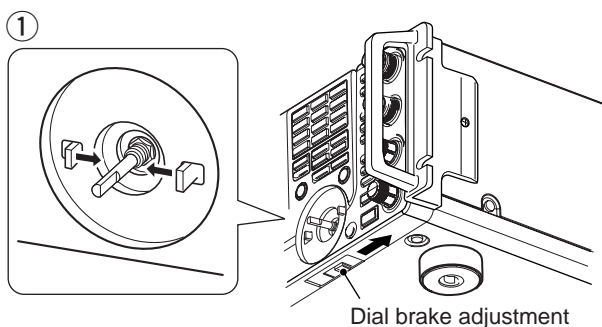

Fig. 1

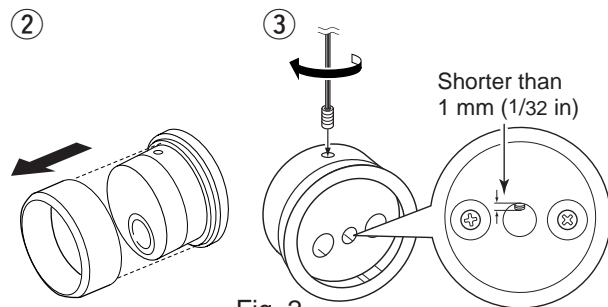

Fig. 2

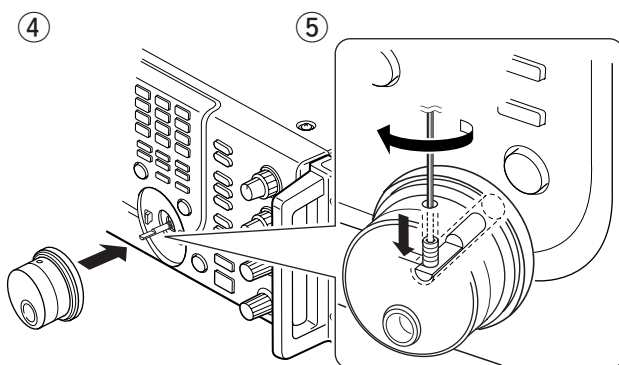

Fig. 3

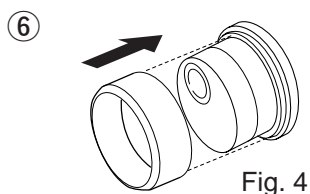
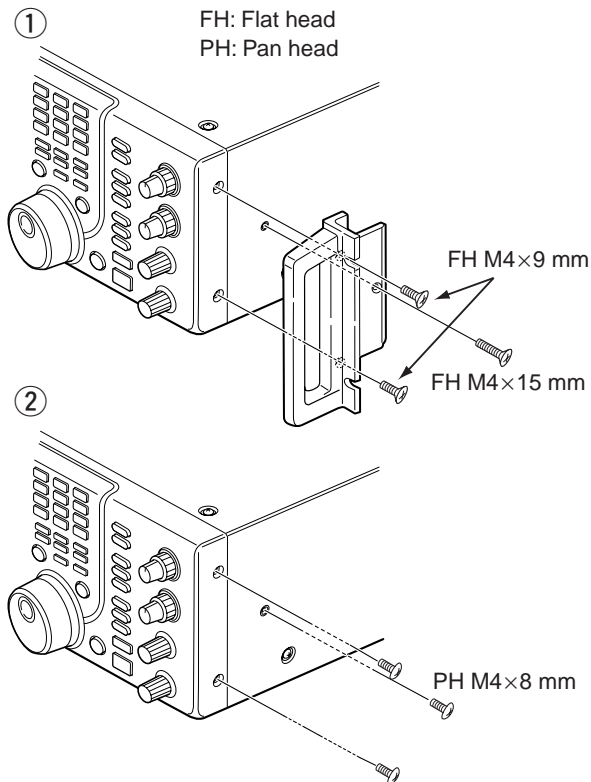

Fig. 4

- ① Slide the dial brake adjustment to the right position (Fig. 1).
 - The dial brakes move inward as shown.
- ② Remove the rubber cover of the main dial (Fig. 2).
- ③ Insert the main dial set-screw into the screw hole of the main dial, then tighten the screw until the screw extends into the shaft hole out slightly using supplied hexagonal wrench (2 mm) (Fig. 2).
 - Be careful that the screw does not extend out more than 1 mm (1/32 in).
- ④ Attach the main dial as illustrated (Fig. 3).
 - Be careful to match the correct orientation of the flat face of the shaft and the screw hole of the dial knob.
- ⑤ Tighten the screw using supplied hexagonal wrench as illustrated (Fig. 3).
- ⑥ Install the rubber cover of the main dial (Fig. 4). Then adjust the main dial brake as desired.

✓ When re-packing and shipping the transceiver: Slide the dial brake adjustment to the right position, then detach the main dial when re-packing and shipping the transceiver at any time.

■ Rack mounting handle detachment



The rack mounting handles are supplied attached to the transceiver to stabilize the transceiver in the shock absorber material in the box. If you want to remove them, use the supplied screws as described below.

- ① Remove the six screws from the rack mounting handles on both side and remove the rack mounting handles.
- ② Tighten the supplied six screws (PH M4×8) on both sides of the front panel and side panel to hide the screw holes on both sides.

✓ **When re-packing and shipping the transceiver:** Attach the rack mounting handles using original screws when re-packing and shipping the transceiver at any time.

■ Selecting a location

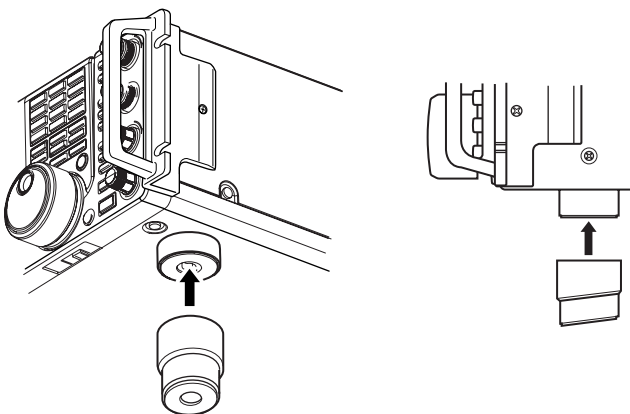

Select a location for the transceiver that allows adequate air circulation, free from extreme heat, cold, or vibrations, and away from TV sets, TV antenna elements, radios and other electromagnetic sources.

The base of the transceiver has an adjustable feet for desktop use. Set the feet to one of two angles depending on your operating preference.

■ Grounding

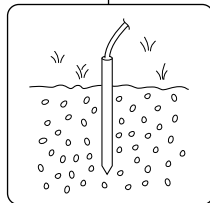
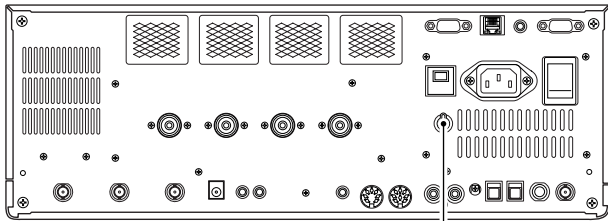

To prevent electrical shock, television interference (TVI), broadcast interference (BCI) and other problems, ground the transceiver through the GROUND terminal on the rear panel.

For best results, connect a heavy gauge wire or strap to a long earth-sunk copper rod. Make the distance between the [GND] terminal and ground as short as possible.

⚠ WARNING: NEVER connect the [GND] terminal to a gas or electric pipe, since the connection could cause an explosion or electric shock.

■ Antenna connection

PL-259 CONNECTOR INSTALLATION EXAMPLE

- ① Slide the coupling ring down. Strip the cable jacket and in the braid.
- ② Strip the cable as shown at left. Tin the center conductor.
- ③ Slide the connector body on and solder it.
- ④ Screw the coupling ring onto the connector body.

30 mm ≈ 9/8 in 10 mm ≈ 3/8 in 1-2 mm ≈ 1/16 in

For radio communications, the antenna is of critical importance, along with output power and receiver sensitivity. Select antenna(s), such as a well-matched 50 Ω antenna, and feedline. We recommend 1.5:1 or better of Voltage Standing Wave Ratio (VSWR) for your desired band. Of course, the transmission line should be a coaxial cable.

When using 1 antenna, use the [ANT1] connector.

⚠ CAUTION: Protect your transceiver from lightning by using a lightning arrester.

Antenna SWR

Each antenna is tuned for a specified frequency range and SWR may be increased out-of-range. When the SWR is higher than approx. 2.0:1, the transceiver's power drops to protect the final transistors. In this case, an antenna tuner is useful to match the transceiver and antenna. Low SWR allows full power for transmitting. The IC-7700 has an SWR meter to monitor the antenna SWR continuously.

■ USB-Memory connection (USB-Memory: Not supplied by Icom)

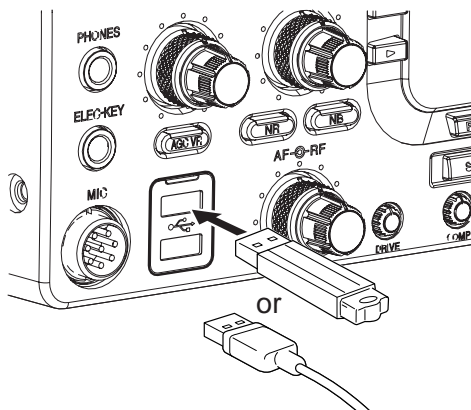

Connect the USB-Memory* to the USB connector.

- Unmount operation is necessary before removing the USB-Memory* (p.12-25).

⚠ Make sure to connect the USB-Memory correctly. **NEVER** connect or remove the USB-Memory when the read/write indicator lights or blinks.

⚠ A USB keyboard* or USB hub* can also be connected to the USB connector.

*: USB-Memory, USB keyboard or USB hub is not supplied by Icom.

Required connections

Front panel

CW key

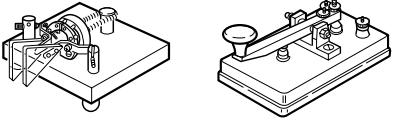

A straight or bug key can be used when the internal electronic keyer is turned OFF in keyer set mode. (p. 4-12)

Microphones (p. 2-10)

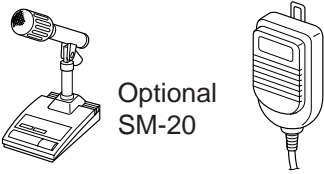

Optional SM-20 Optional HM-36

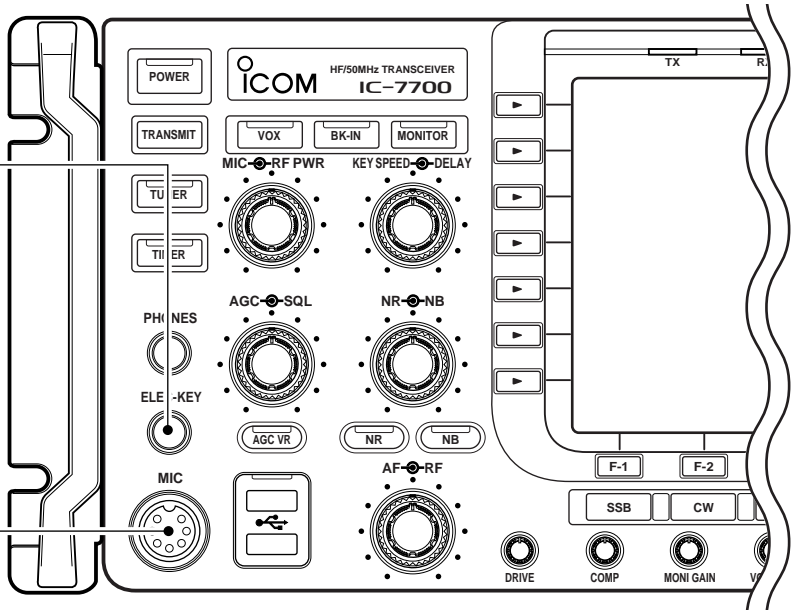

Rear panel

Ground (p. 2-4)

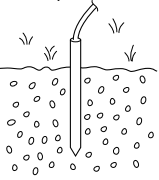

Use the heaviest gauge wire or strap available and make the connection as short as possible.

Grounding prevents electrical shocks, TVI and other problems.

AC outlet

WARNING:
Use the supplied AC power cable only.

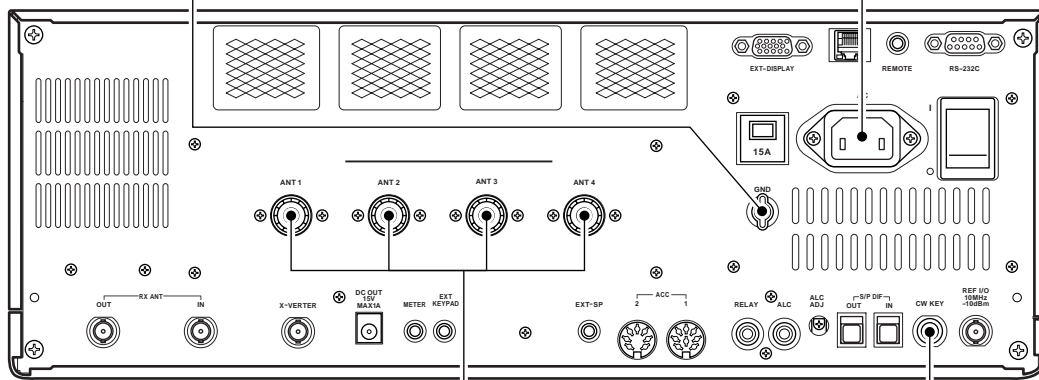

Antenna 1, 2, 3, 4 (p. 2-4)

[Example]: ANT1 for 1.8—18 MHz bands, ANT 2 for 21—28 MHz bands, ANT3 for 50 MHz band, ANT 4 for receive antenna.

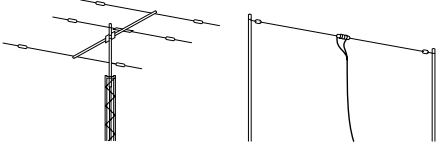

NOTE: Attach the supplied antenna connector cap when no antenna or external equipment is connected.

Straight key

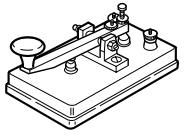

Advanced connections

Front panel

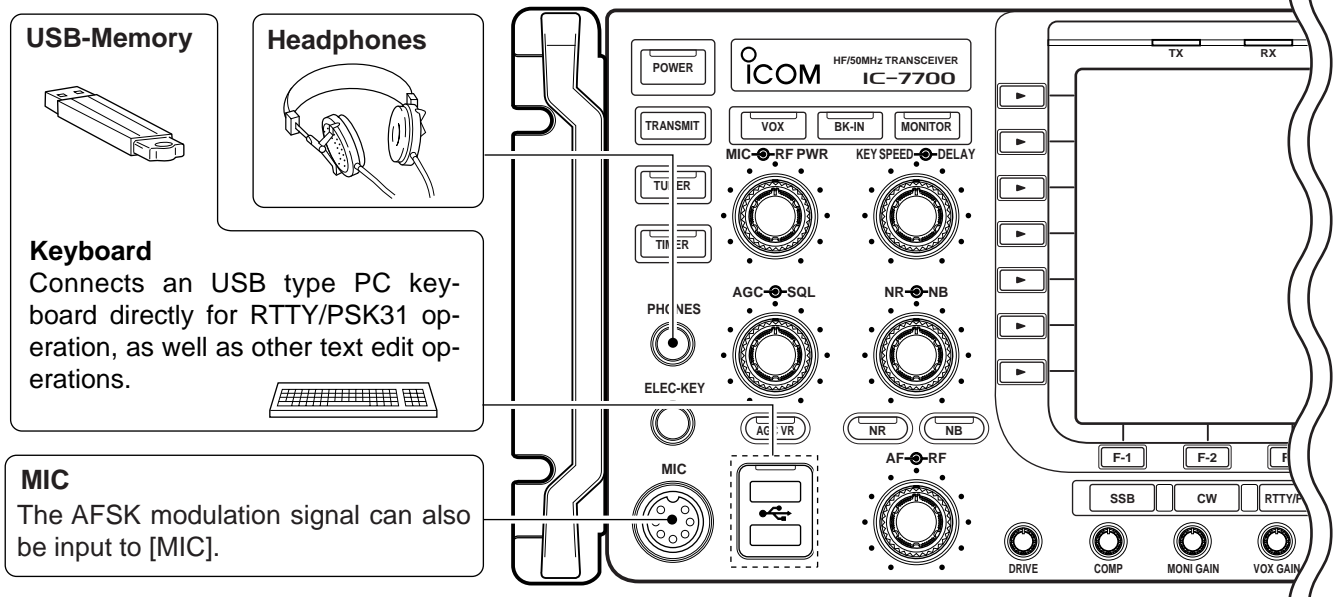

Rear panel— 1

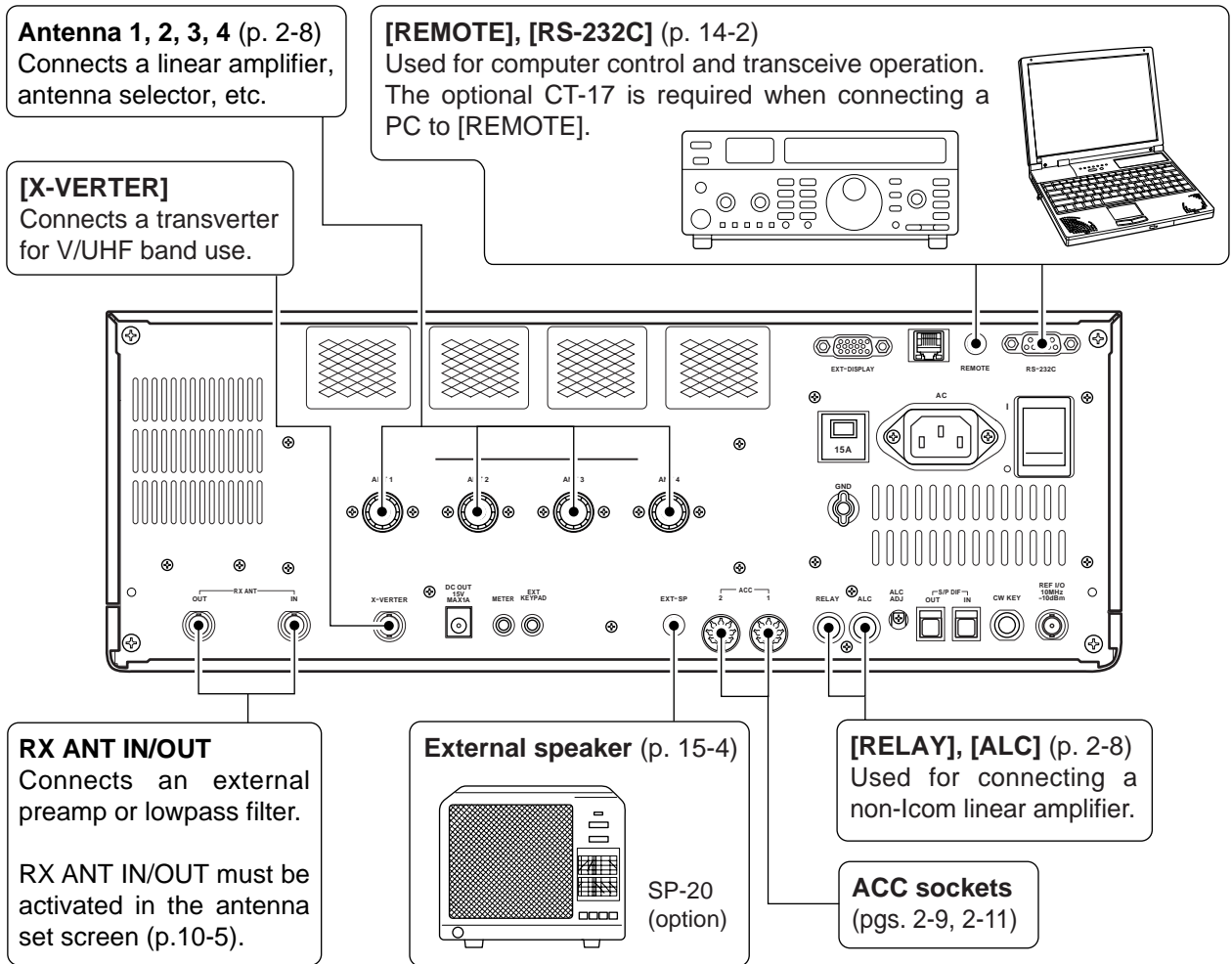

◇ Rear panel— 2

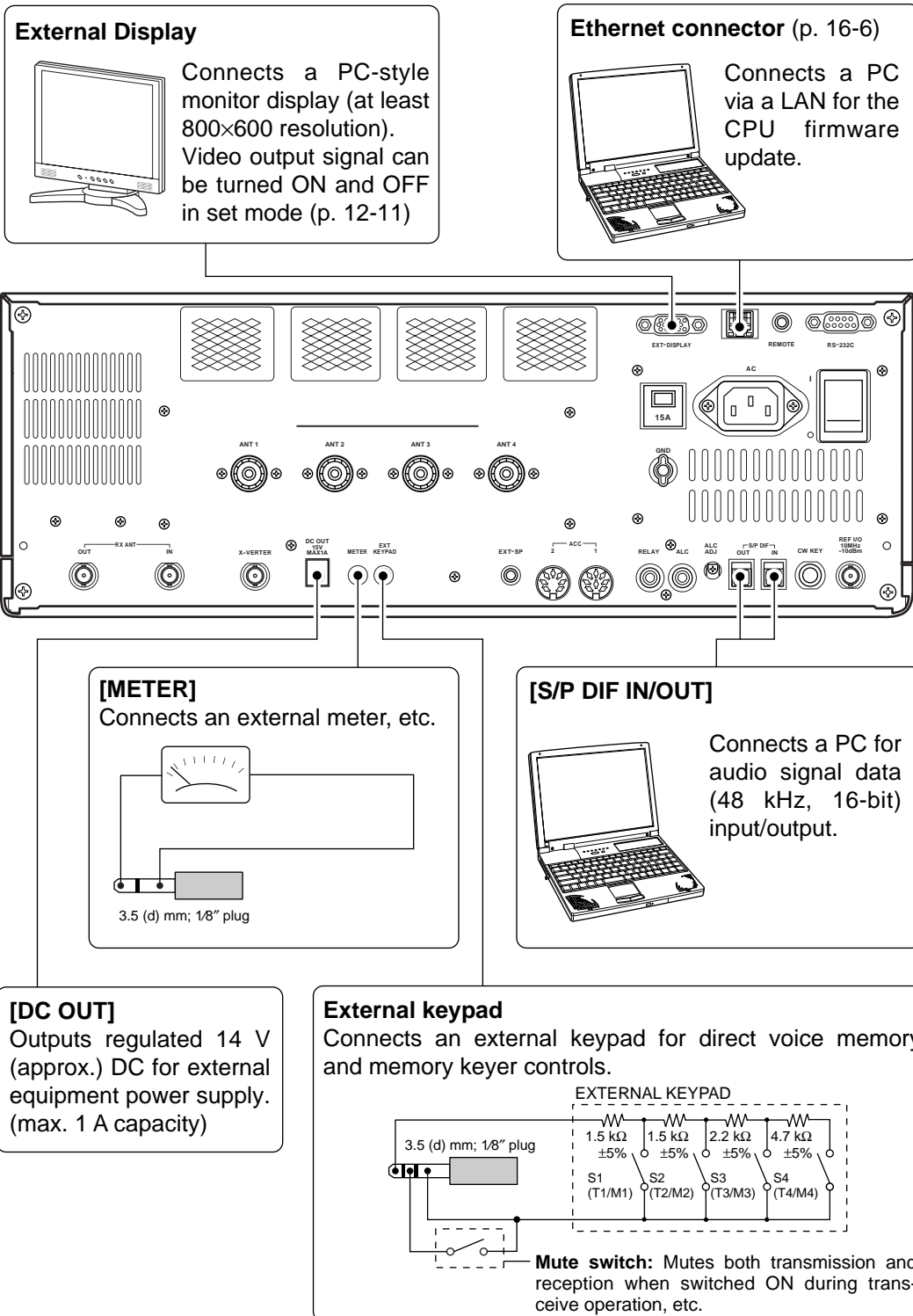

■ Linear amplifier connections

◇ Connecting the IC-PW1/EURO

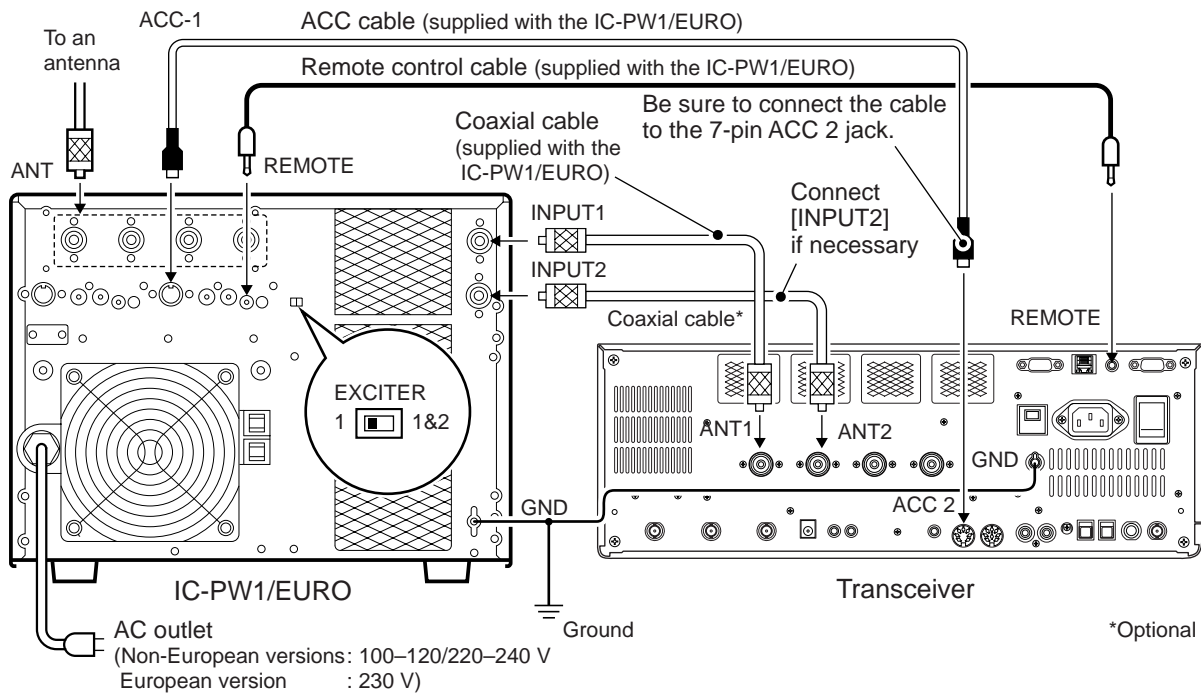

◇ Connecting a non-Icom linear amplifier

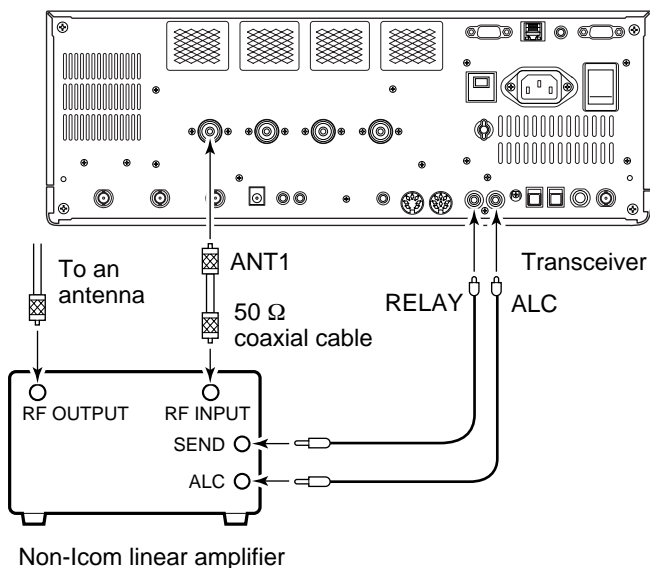

⚠ WARNING:

Set the transceiver output power and linear amplifier ALC output level after referring to the linear amplifier instruction manual.

The ALC input level must be in the range 0 V to -4 V. The transceiver does not accept positive voltage. Non-matched ALC and RF power settings could overheat or damage the linear amplifier.

The maximum signal level of [RELAY] jack is 16 V/0.5 A DC with initial setting, and 250 V/200 mA with "MOSFET" setting (see p. 12-8 for details). Use an external relay unit if your non-Icom linear amplifier requires control voltage and/or current greater than specified.

■ Transverter jack information

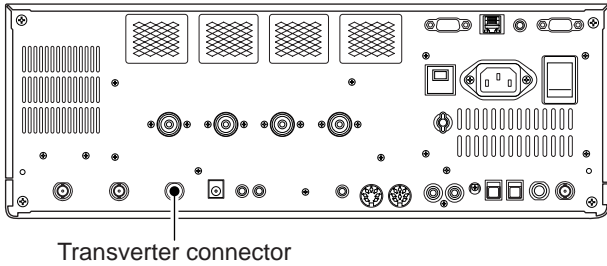

When 2 to 13.8 V is applied to pin 6 of [ACC 2], the [X-VERTER] connector is activated for transverter operation and the antenna connectors do not receive or transmit any signals.

While receiving, [X-VERTER] connector can be activated as an input terminal from an external transverter.

While transmitting, the [X-VERTER] connector outputs signals of the displayed frequency at -20 dBm (22 mV) as signals for the external transverter.

■ FSK and AFSK (SSTV) connections

To connect a TNC or scan converter, etc., refer to the diagram below.

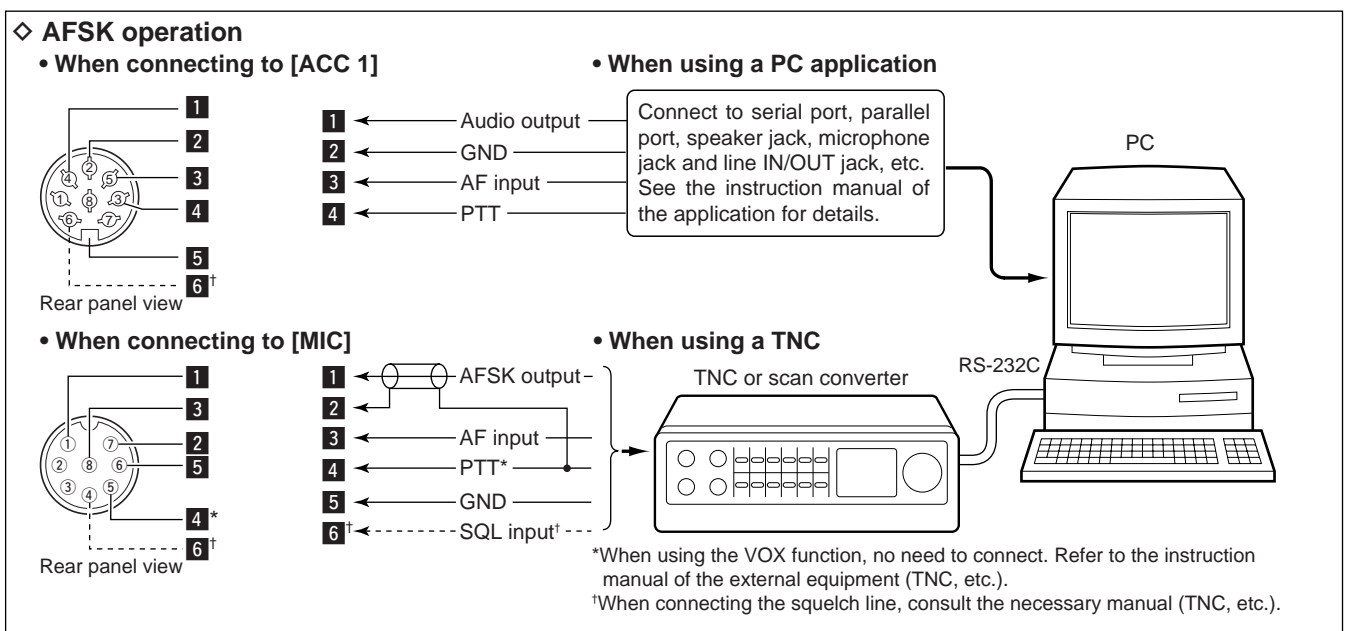
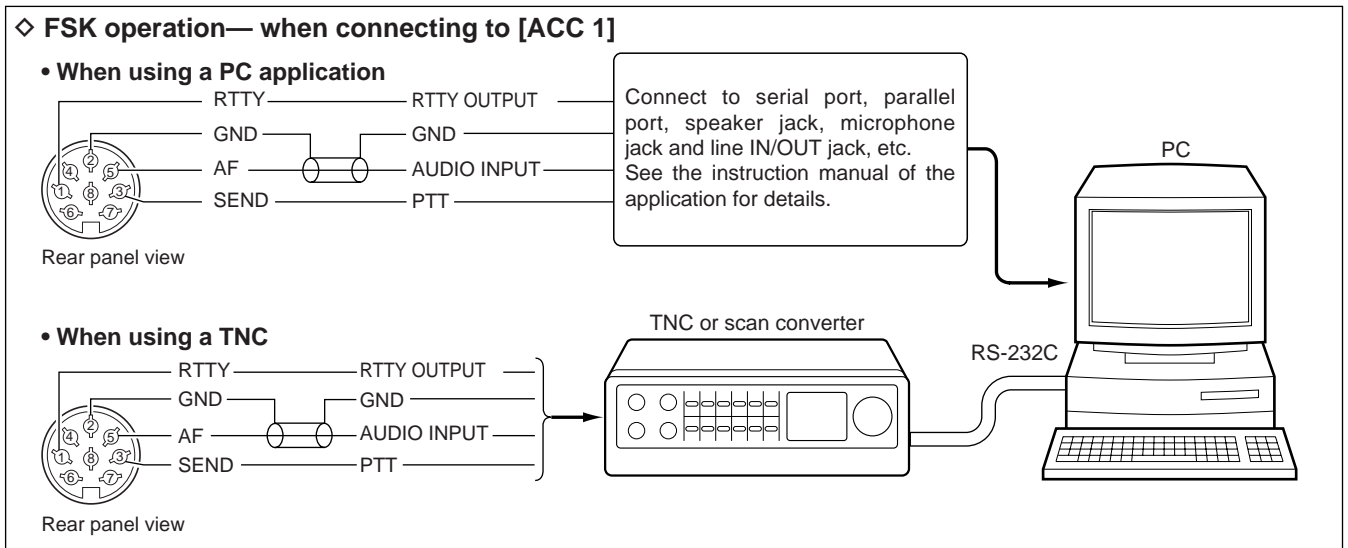

Microphone connector information

(Front panel view)

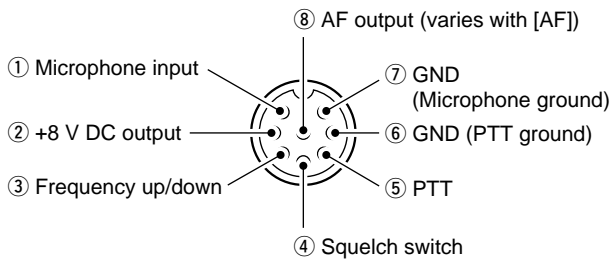

[MIC] Pin No.	FUNCTION	DESCRIPTION
②	+8 V DC output	Max. 10 mA
③	Frequency up	Ground
	Frequency down	Ground through 470 Ω
④	Squelch open	"Low" level
	Squelch closed	"High" level

CAUTION: DO NOT short pin 2 to ground as this can damage the internal 8 V regulator.

NOTE: DC voltage is applied to pin 1 for microphone operation. Use caution when using a non-lcom microphone.

Microphones (options)

◇ SM-20

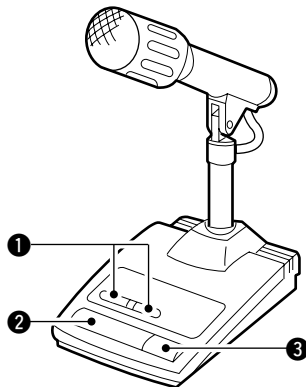

◇ HM-36

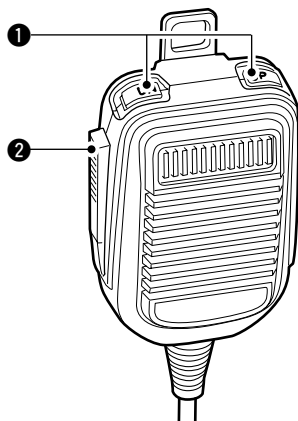

① UP/DOWN SWITCHES [UP]/[DN]

Change the selected readout frequency or memory channel.

- Continuous pushing changes the frequency or memory channel number continuously.
- While pushing [XFC], the transmit readout frequency can be controlled while in split frequency operation.
- The [UP]/[DN] switch can simulate a key paddle. Preset in the keyer set mode. (p. 4-12)

② PTT SWITCH

Push and hold to transmit; release to receive.

③ PTT LOCK SWITCH (available for SM-20 only)

Push to toggle between transmit and receive.

■ Accessory connector information

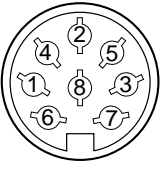
ACC 1	PIN No.	NAME	DESCRIPTION	SPECIFICATIONS
	1	RTTY	Controls RTTY keying	"High" level : More than 2.4 V "Low" level : Less than 0.6 V Output current : Less than 2 mA
	2	GND	Connects to ground.	Connected in parallel with ACC 2 pin 2.
	3	SEND	Input/output pin. Goes to ground when transmitting. When grounded, transmits.	Ground level : -0.5 V to 0.8 V Output current : Less than 20 mA Input current (Tx) : Less than 200 mA Connected in parallel with ACC 2 pin 3.
	4	MOD	Modulator input. Connects to a modulator.	Input impedance : 10 kΩ Input level : Approx. 100 mV rms
	5	AF	AF detector output. Fixed, regardless of [AF] position in default settings. (see notes below)	Output impedance : 4.7 kΩ Output level : 100-300 mV rms
	6	SQLS	Squelch output. Goes to ground when squelch opens.	SQL open : Less than 0.3 V/5 mA SQL closed : More than 6.0 V/100 μA
	7	13.8 V	13.8 V output when power is ON.	Output current : Max. 1 A Connected in parallel with ACC 2 pin 7.
	8	ALC	ALC voltage input.	Control voltage : -4 V to 0 V Input impedance : More than 10 kΩ Connected in parallel with ACC 2 pin 5.

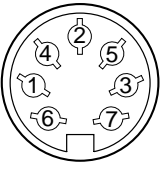
ACC 2	PIN No.	NAME	DESCRIPTION	SPECIFICATIONS
	1	8 V	Regulated 8 V output.	Output voltage : 8 V ±0.3 V Output current : Less than 10 mA
	2	GND	Same as ACC 1 pin 2.	
	3	SEND	Same as ACC 1 pin 3.	
	4	BAND	Band voltage output. (Varies with amateur band)	Output voltage : 0 to 8.0 V
	5	ALC	Same as ACC 1 pin 8.	
	6	TRV	Activates [X-VERTER] input/output when "HIGH" voltage is applied.	Input impedance : More than 10 kΩ Input voltage : 2 to 13.8 V
	7	13.8 V	Same as ACC 1 pin 7.	

NOTE: If the CW side tone level limit or beep level limit is in use, the CW side tone or beep tone decreases from the fixed level when the [AF] control is rotated above a specified level. (p. 12-6)

■ When first applying power (CPU resetting)	3-2
■ Initial settings	3-2
■ Selecting VFO/memory mode	3-3
■ VFO selection	3-3
◇ Selecting VFO-A/VFO-B	3-3
◇ VFO equalization	3-3
■ Selecting an operating band	3-4
◇ Using the band stacking registers	3-4
■ Frequency setting	3-5
◇ Tuning with the main dial	3-5
◇ Direct frequency entry with the keypad	3-5
◇ Quick tuning step	3-6
◇ Selecting "kHz" step	3-6
◇ 1/4 tuning step function	3-6
◇ Selecting 1 Hz step	3-7
◇ Auto tuning step function	3-7
◇ Band edge warning beep	3-7
■ Operating mode selection	3-8
■ Volume setting	3-9
■ RF gain adjustment	3-9
■ Squelch level adjustment	3-9
■ Meter indication selection	3-10
◇ Multi-function digital meter	3-10
◇ Meter type selection	3-11
■ Voice synthesizer operation	3-11
■ Basic transmit operation	3-12
◇ Transmitting	3-12
◇ Microphone gain adjustment	3-12
◇ Drive gain adjustment	3-13

■ When first applying power (CPU resetting)

Before first applying power, make sure all connections required for your system are complete by referring to Section 2. Then, reset the transceiver using the following procedure.

Resetting **CLEARs** all programmed contents in memory channels and returns programmed values in set mode to default values.

- ① Turn the main power ON with [I/O] on the rear panel.
 - The transceiver power is still OFF and the power indicator lights orange.
- ② While pushing and holding [F-INP ENT] and [MW], push [POWER] to turn power ON.
 - The CPU is reset.
 - The CPU start-up takes approx. 5 sec.
 - The transceiver displays its initial VFO frequencies when resetting is complete.
- ③ Change the set mode settings after resetting, if desired.

In cooler temperatures, the LCD may appear dark and unstable after turning power ON. This is normal and does not indicate any equipment malfunction.

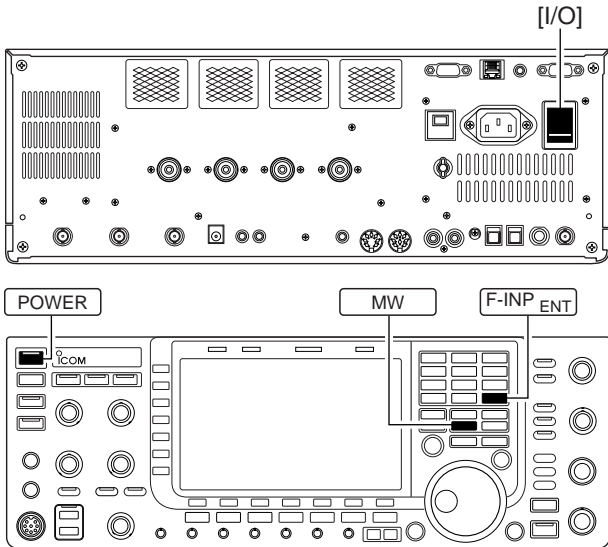

■ Initial settings

After resetting the transceiver, set controls as shown in the figure below.

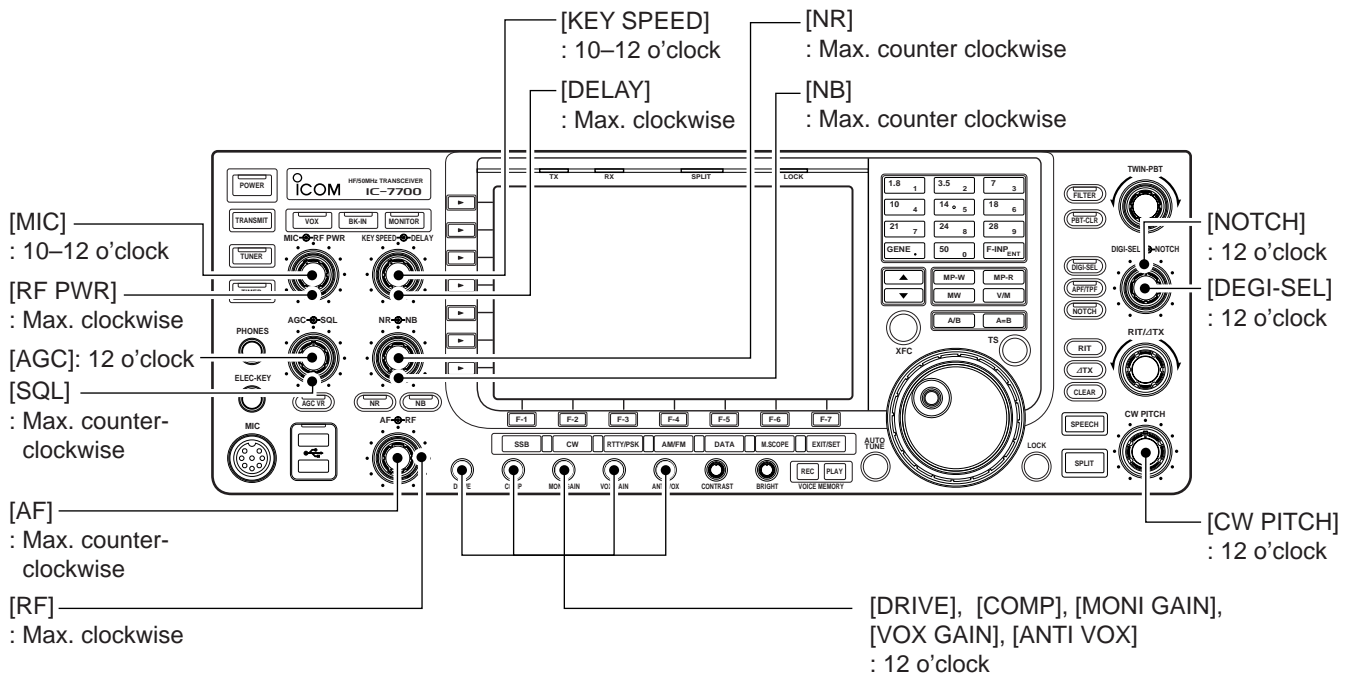

■ Selecting VFO/memory mode

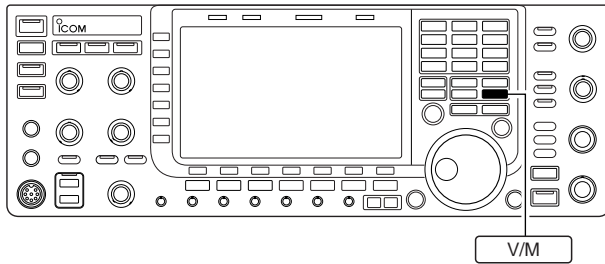

➔ Push **V/M** to switch between VFO and memory modes.

- "**VFO-A**" or "**VFO-B**" appears when in VFO mode, or the selected memory channel number appears when in memory mode.
- Pushing and holding **V/M** for 1 sec. transfers the contents of the selected memory channel to VFO. (p. 8-4)



■ VFO selection

VFO is an abbreviation of Variable Frequency Oscillator, and is commonly referred to as a main tuning function.

The main dial is often called the "VFO knob."

◇ Selecting VFO-A/VFO-B

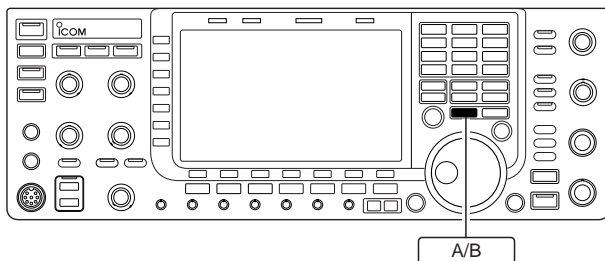

➔ In VFO mode, push **A/B** to toggle VFO-A and VFO-B.

- "**VFO-A**" or "**VFO-B**" appears when VFO-A or VFO-B is selected, respectively

◇ VFO equalization

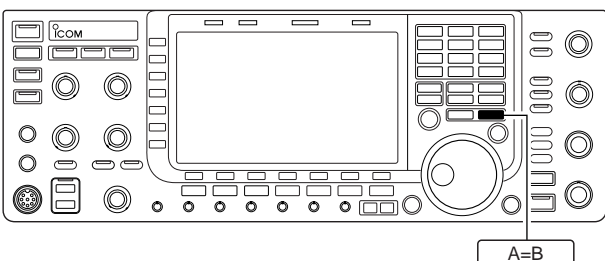

➔ In VFO mode, push and hold **A=B** for 1 sec. to set the undisplayed VFO frequency and mode to those of the displayed VFO.

- Three beeps sound when the VFO equalization is completed.

■ Selecting an operating band

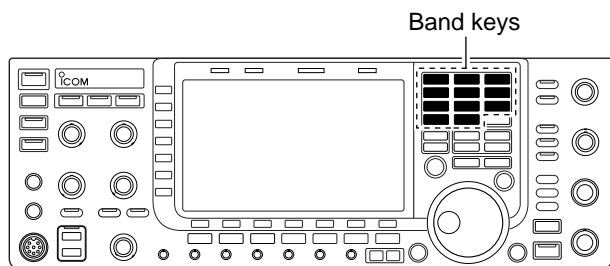

The triple band stacking register provides 3 memories for each band key, storing frequency and mode information.

This function is convenient when you operate 3 modes on one band. For example, one register is used for a CW frequency, another for an SSB frequency and the other one for an RTTY frequency.

If a band key is pushed once, the frequency and operating mode last used are called up. When the key is pushed again, another stored frequency and operating mode are called up.

See the table below for a list of the bands available and the default settings for each band.

BAND	REGISTER 1	REGISTER 2	REGISTER 3
1.8 MHz	1.900000 MHz CW	1.910000 MHz CW	1.915000 MHz CW
3.5 MHz	3.550000 MHz LSB	3.560000 MHz LSB	3.580000 MHz LSB
7 MHz	7.050000 MHz LSB	7.060000 MHz LSB	7.020000 MHz CW
10 MHz	10.120000 MHz CW	10.130000 MHz CW	10.140000 MHz CW
14 MHz	14.100000 MHz USB	14.200000 MHz USB	14.050000 MHz CW
18 MHz	18.100000 MHz USB	18.130000 MHz USB	18.150000 MHz USB
21 MHz	21.200000 MHz USB	21.300000 MHz USB	21.050000 MHz CW
24 MHz	24.950000 MHz USB	24.980000 MHz USB	24.900000 MHz CW
28 MHz	28.500000 MHz USB	29.500000 MHz USB	28.100000 MHz CW
50 MHz	50.100000 MHz USB	50.200000 MHz USB	51.000000 MHz FM
General	15.000000 MHz USB	15.100000 MHz USB	15.200000 MHz USB

◇ Using the band stacking registers

[Example]: 14 MHz band

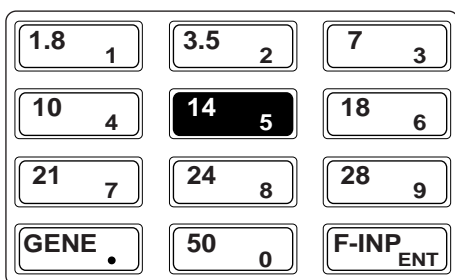

- ① Push **14 5**, then select a frequency and an operating mode.
 - Frequency and operating mode are memorized in the first band stacking register.
- ② Push **14 5** again, then tune to another frequency and operating mode.
 - This frequency and operating mode are memorized in the second band stacking register.
- ③ Push **14 5** again, then tune to another frequency and operating mode.
 - This frequency and operating mode are memorized in the third band stacking register.
 - When a fourth frequency and operating mode are selected on a band, the first register set in step ①, is overwritten.

Frequency setting

The transceiver has several tuning methods for convenient frequency tuning.

◇ Tuning with the main dial

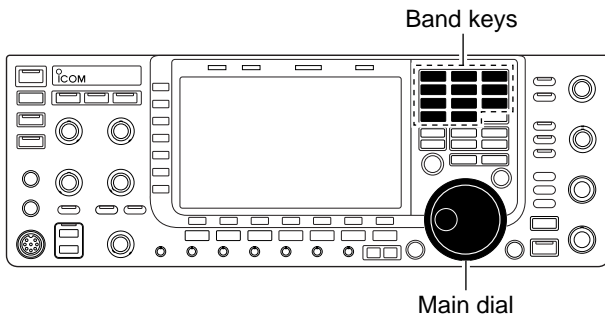

- ① Push the desired band key on the keypad 1–3 times.
 - 3 different frequencies can be selected on each band with the band key.
- ② Rotate the main dial to set the desired frequency.

▨ If the dial lock function is activated, the lock indicator lights, and the main dial does not function. In this case, push [LOCK] to deactivate the lock function. (see p. 5-17 for details)

◇ Direct frequency entry with the keypad

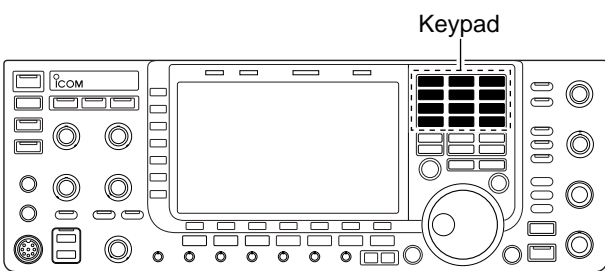

The transceiver has a keypad for direct frequency entry as described below.

- ① Push [F-INP ENT].
 - “F-INP” indicator appears and keypad backlight lights.
- ② Input the desired frequency
 - Push [GENE.] to input “. (decimal point)” between the MHz units and kHz units.
- ③ Push [F-INP ENT] to set the input frequency.
 - To cancel the input, push [▲] / [▼] instead of [F-INP ENT].

[EXAMPLE]

7.0000 MHz

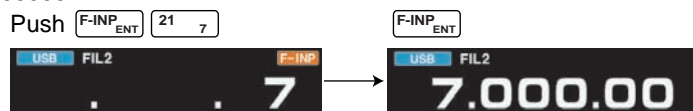

21.2400 MHz

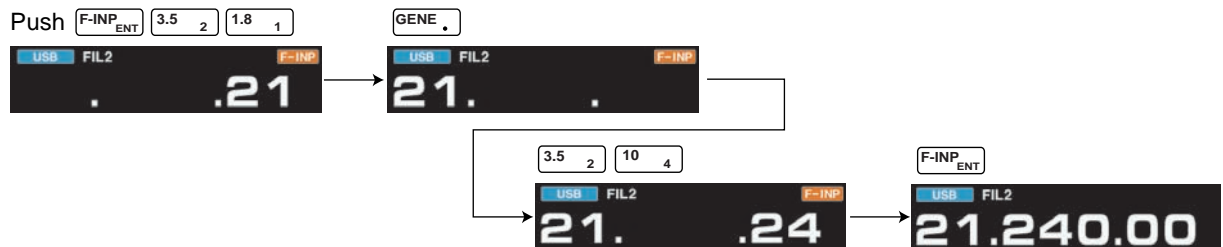

21.2400 MHz ⇒ 21.3600 MHz



850 kHz (0.85000 MHz)



3 BASIC OPERATIONS

◇ Quick tuning step

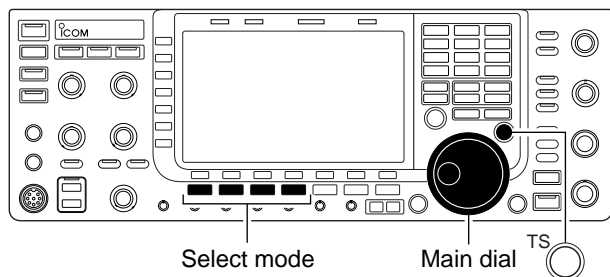

Quick tuning indicator



The operating frequency can be changed in larger steps (0.1, 1, 5, 9, 10, 12.5, 20 or 25 kHz selectable) for quick tuning.

- ① Push [TS] to turn the quick tuning function ON.
 - “▼” appears when the quick tuning function is ON.
- ② Rotate the main dial to change the frequency in programmed kHz steps.
- ③ Push [TS] again to turn OFF the indicator.
- ④ Rotate the main dial for normal tuning if desired.

◇ Selecting “kHz” step



- ① Push [TS] to turn the quick tuning function ON and OFF.
 - “▼” appears when the quick tuning function ON.
- ② Push and hold [TS] for 1 sec. to enter quick tuning step set mode.
 - Selected tuning steps for all modes appear.
- ③ Select the desired operating mode.
- ④ Rotate the main dial to select the desired tuning step.
- ⑤ Repeat steps ③ and ④ to select quick tuning steps for other modes, if desired.
- ⑥ Push [EXIT/SET] to exit the setting display.

NOTE: When entering quick tuning step set mode, the quick tuning function must be activated first.

◇ 1/4 tuning step function

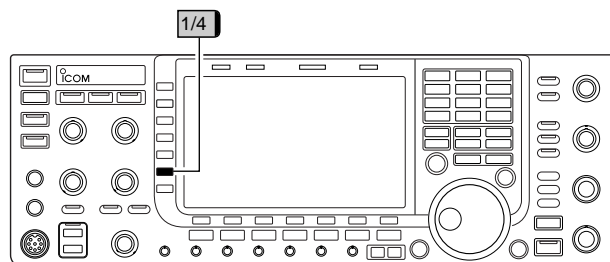

1/4 tuning step OFF 1/4 tuning step ON



When operating in SSB data, CW, RTTY or PSK, the 1/4 tuning function is available. Dial rotation is reduced to 1/4 of normal speed when the 1/4 tuning function is ON for finer tuning control.

- Push [1/4] (MF6) to toggle the 1/4 tuning function ON and OFF.
 - “1/4” appears when the 1/4 tuning function is ON.

◇ Selecting 1 Hz step



A minimum tuning step of 1 Hz can be used for fine tuning.

- ① Push [TS] to turn the quick tuning function OFF.
- ② Push and hold [TS] for 1 sec. to turn the 1 Hz tuning step ON and OFF.

◇ Auto tuning step function

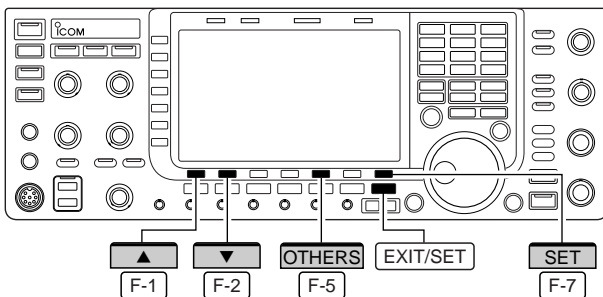

When rotating the main dial rapidly, the tuning speed accelerates automatically as selected.

- ① Push [EXIT/SET] several times to close a multi-function screen, if necessary.
- ② Push [F-7•SET] to select set mode menu screen.
 - Pushing and holding [EXIT/SET] for 1 sec. also selects set mode menu screen.
- ③ Push [F-5•OTHERS] to enter Others set mode.
- ④ Push [F-1•▲] or [F-2•▼] to select "MAIN DIAL Auto TS."
- ⑤ Rotate the main dial to select the desired condition from high, low and OFF.
 - High : Approx. 5 times faster
 - Low : Approx. twice faster
 - OFF : Auto tuning step is turned OFF.
- ⑥ Push [EXIT/SET] to exit the set mode.

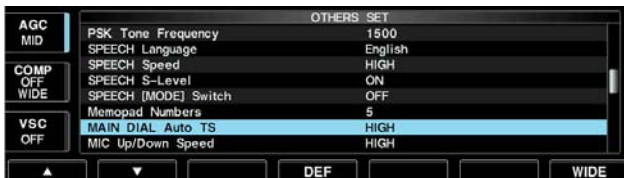

◇ Band edge warning beep

When you tune outside of an amateur band's frequency range, a warning beep sounds.

This function can be turned OFF in set mode, if desired.

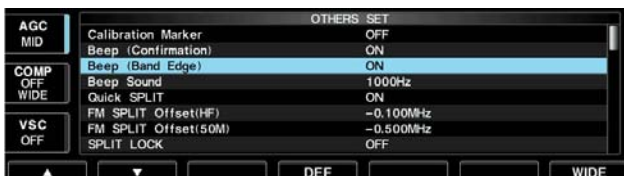

- ① Push [EXIT/SET] several times to close a multi-function screen, if necessary.
- ② Push [F-7•SET] to select set mode menu screen.
 - Pushing and holding [EXIT/SET] for 1 sec. also selects set mode menu screen.
- ③ Push [F5•OTHERS] to enter Others set mode.
- ④ Push [F-1•▲] or [F-2•▼] to select "Beep (Band Edge)."
- ⑤ Rotate the main dial to turn the band edge warning beep ON and OFF.
- ⑥ Push [EXIT/SET] to exit the set mode.

■ Operating mode selection

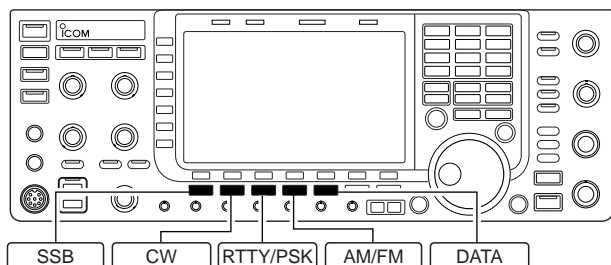

SSB (USB/LSB), SSB data (USB data/LSB data), CW, CW reverse (CW-R), RTTY, RTTY reverse (RTTY-R), PSK, PSK reverse (PSK-R), AM, AM data, FM and FM data modes are available in the IC-7700. Select the desired operation mode as follows.

To select a mode of operation, push the desired mode switch momentarily. Push the switch again to toggle between USB and LSB, CW and CW-R, RTTY/RTTY-R and PSK/PSK-R, AM and FM, if desired. Push and hold the switch for 1 sec. to toggle between RTTY and RTTY-R, PSK and PSK-R, if desired.

See the diagram below left for the order of selection.

Microphone signals are muted when data mode is selected.

• Selecting SSB mode

- Push **SSB** to select USB or LSB.
 - USB is selected first when above 10 MHz; or LSB is selected first when below 10 MHz operation. (USB is selected when 5 MHz band is selected for the USA version.)
 - After USB or LSB is selected, push **SSB** to toggle between USB and LSB.

• Selecting CW mode

- Push **CW** to select CW.
 - After CW is selected, push **CW** to toggle between CW and CW reverse mode.

• Selecting RTTY/PSK mode

- Push **RTTY/PSK** to select RTTY or PSK.
 - After RTTY or PSK is selected, push **RTTY/PSK** to toggle between RTTY and PSK.
 - After RTTY or PSK is selected, push and hold **RTTY/PSK** for 1 sec. to toggle between RTTY and RTTY reverse, or, PSK and PSK reverse mode, respectively.

• Selecting AM/FM mode

- Push **AM/FM** to select AM or FM.
 - After AM or FM is selected, push **AM/FM** to toggle between AM and FM.

• Selecting DATA mode

- After USB, LSB, AM or FM is selected, push **DATA** to select USB data, LSB data, AM data or FM data mode, respectively.
 - After data mode is selected, push **DATA** to toggle between regular voice and data mode.
 - After data mode is selected, push and hold **DATA** for 1 sec. to select data 1, 2 and 3 in sequence.

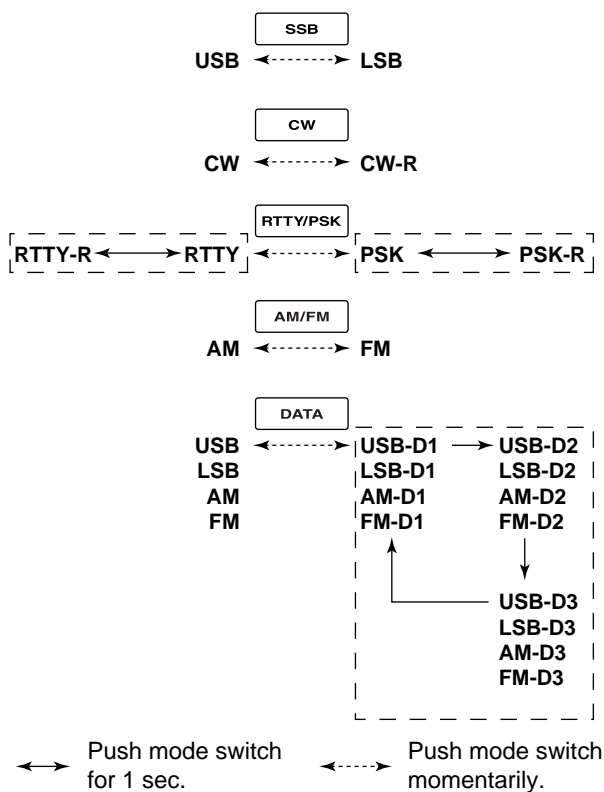

■ Volume setting

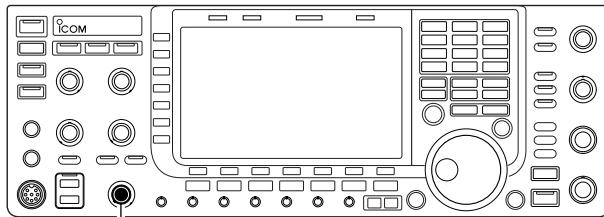

[AF]

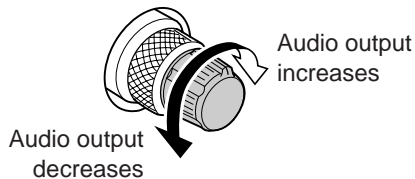

- Rotate [AF] control clockwise to increase, counterclockwise to decrease the audio output level.
 - Set a suitable audio level.

■ RF gain adjustment

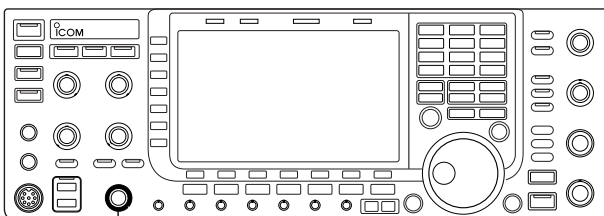

[RF]

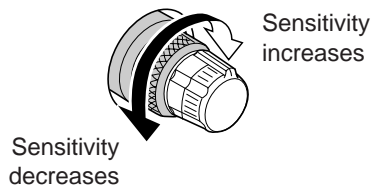

- Rotate [RF] control clockwise to increase, counterclockwise to decrease the receiver sensitivity.

NOTE:

When [RF] control is adjusted CCW in FM mode, audio output decreases then disappears. This is normal, not a malfunction.

■ Squelch level adjustment

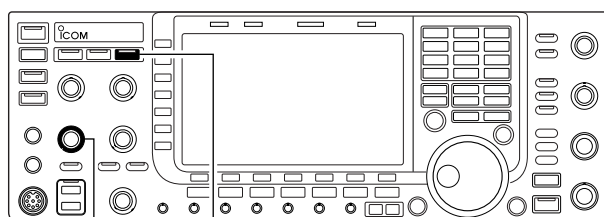

[SQL]

MONITOR

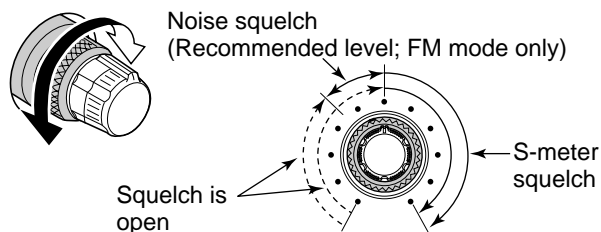

The squelch mutes noise output from the speaker (closed squelch) when no signal is received.

- When no signal is received, rotate [SQL] control fully counterclockwise first, then rotate [SQL] clockwise to the point that the noise just disappears.
 - Push and hold **MONITOR** to open the squelch temporarily.

■ Meter indication selection

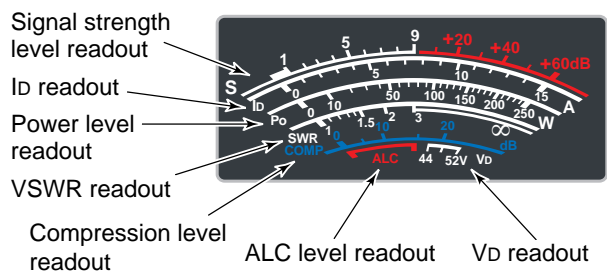
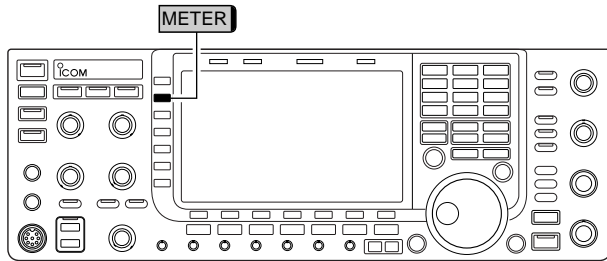

The S/RF meter indication, during transmit, can be selected from the following items as you desire.

➔ Push [METER] (MF2) several times to select the desired item.

- METER P_o** Indicates the RF output power in watts.
- METER SWR** Indicates the VSWR on the transmission line.
- METER ALC** Indicates the ALC level. The ALC circuit begins to activate when the RF output power reaches a preset level.
- METER COMP** Indicates the compression level when the speech compressor is in use.
- METER I_d** Indicates the drain current of the final amplifier MOSFETs.
- METER V_d** Indicates the drain terminal voltage of the final amplifier MOSFETs.

◇ Multi-function digital meter

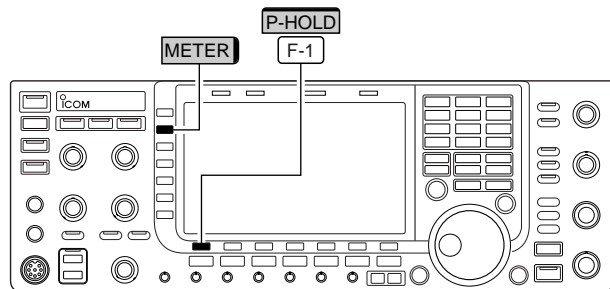

The IC-7700 can display the multi-function digital meter on the LCD display. This meter displays all transmit parameters simultaneously.

- ① Push and hold [METER] for 1 sec. to turn the multi-function digital meter ON.
- ② Push [F-1•P-HOLD] to toggle the peak level hold function ON.
 - “P-HOLD” appears on the window title when the peak level hold function is ON.
- ③ Push and hold [METER] for 1 sec., or push [EXIT/SET] to turn the multi-function digital meter OFF.

“P-HOLD” indicator

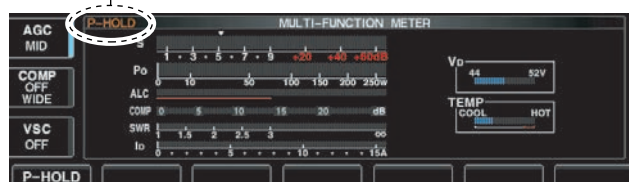

◇ Meter type selection

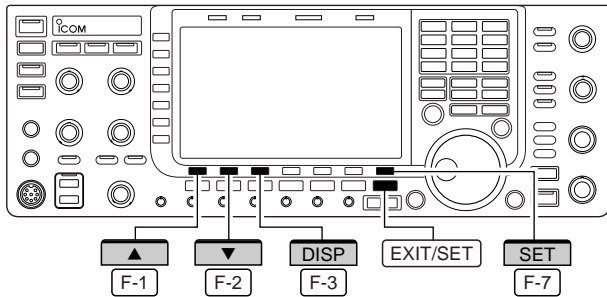

A total of 3 meter types are available in the IC-7700—Standard, Edgewise and Bar meters. Follow the instructions below for the meter type selection.

- ① Push [EXIT/SET] several times to return to normal screen, if necessary.
- ② Push [F-7•SET], then push [F-3•DISP] to select display set mode.
- ③ Push [F-1•▲] or [F-2•▼] to select “Meter type (Normal Screen)” item.
- ④ Rotate the main dial to select the desired meter type from “Standard,” “Edgewise” and “Bar.”
- ⑤ Push [EXIT/SET] to exit display set mode.



• Edgewise meter

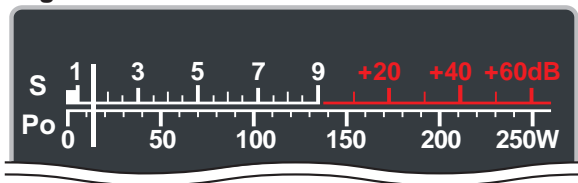

• Bar meter



■ Voice synthesizer operation

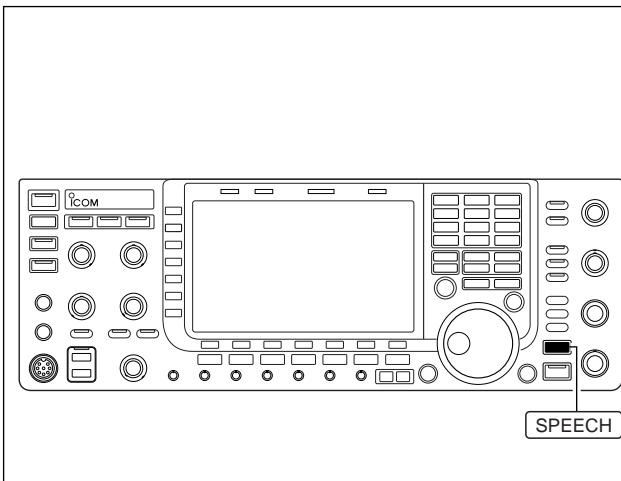

The IC-7700 has built-in voice synthesizer to announce the frequency, mode, etc. (S-meter level can also be announced—p. 12-15) in clear, electronically-generated voice, in English (or Japanese).

- ➔ Push [SPEECH] to announce the currently selected frequency, etc.
 - Push and hold [SPEECH] for 1 sec. to additionally announce the selected mode.
- ➔ Pushing a mode switch also announces the appropriate mode. (p. 12-15)

▨ The output level of the voice synthesizer can be adjusted in level set mode. (p. 12-6)

Basic transmit operation

Before transmitting, monitor your selected operating frequency to make sure transmitting won't cause interference to other stations on the same frequency. It's good amateur practice to listen first, and then, even if nothing is heard, ask "is the frequency in use" once or twice, before you begin operating on that frequency.

Transmitting

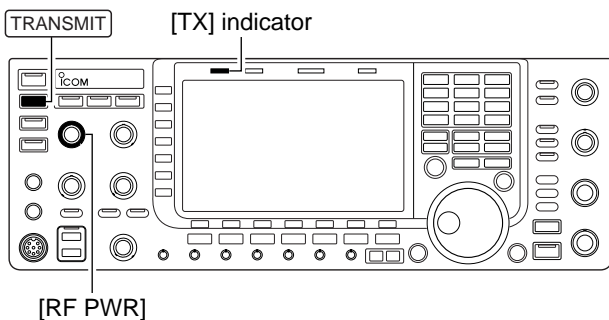

Before transmitting, monitor your selected operating frequency to make sure transmitting won't cause interference to other stations on the same frequency.

- ① Push **TRANSMIT** or **[PTT]** (microphone) to transmit.
 - The **[TX]** indicator lights red.
- ② Push **TRANSMIT** again or release **[PTT]** (microphone) to return to receive.

Adjusting the transmit output power

- ➔ Rotate **[RF PWR]**.
 - Adjustable range : 5 W to 200 W
(AM mode: 5 W to 50 W)

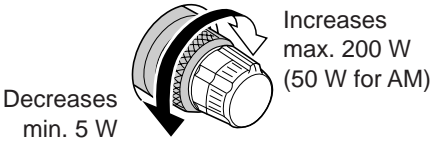

Microphone gain adjustment

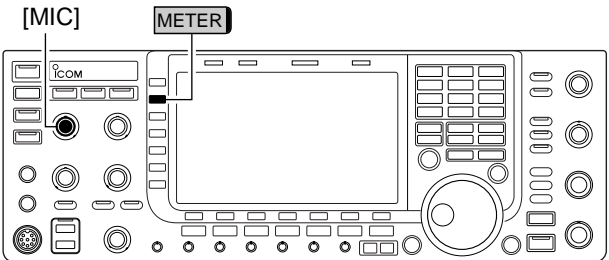

Before transmitting, monitor your selected operating frequency to make sure transmitting won't cause interference to other stations on the same frequency.

- ① Push **[METER]** (MF2) to select the ALC meter.
- ② Push **[PTT]** (microphone) to transmit.
 - Talk into the microphone at your normal voice level.
- ③ While talking into the microphone, rotate **[MIC]** so that the ALC meter reading doesn't go outside the ALC zone. (see at left)
- ④ Release **[PTT]** (microphone) to return to receive.

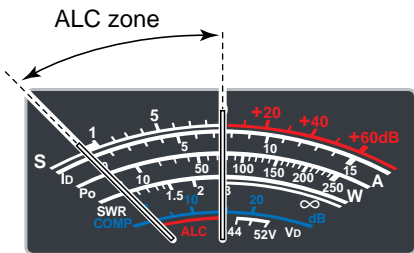

◇ Drive gain adjustment

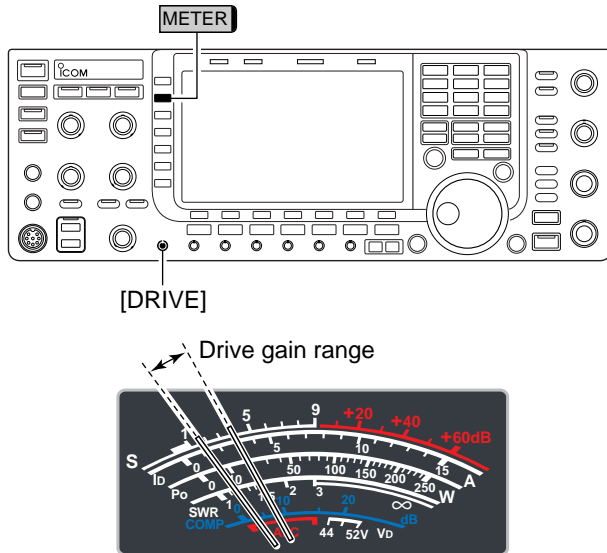

The drive gain is active for all modes other than SSB mode with speech compressor OFF. The [DRIVE] control adjusts the amplifying gain at the driver stage.

Before transmitting, monitor your selected operating frequency to make sure transmitting won't cause interference to other stations on the same frequency.

- ① Push [METER] (MF2) to select the ALC meter.
- ② Push [PTT] (microphone; SSB with [COMP] ON, AM or FM), key down (CW) or push [TRANSMIT] (RTTY or PSK) to transmit.
- ③ While talking into the microphone, keying down or transmitting, rotate [DRIVE] so that the ALC meter reading is between 30 to 50% of the ALC scale. (see left)
 - Talk into the microphone at your normal voice level.
- ④ Release [PTT], stop keying or push [TRANSMIT] again to return to receive.

■ Operating SSB	4-2
◇ Convenient functions for receive	4-2
◇ Convenient functions for transmit	4-3
◇ About 5 MHz band operation (USA version only)	4-3
■ Operating CW	4-4
◇ Convenient functions for receive	4-4
◇ Convenient functions for transmit	4-5
◇ About CW reverse mode	4-5
◇ About CW pitch control	4-5
◇ CW side tone function	4-5
◇ APF (Audio Peak Filter) operation	4-6
■ Electronic keyer functions	4-7
◇ Memory keyer screen	4-8
◇ Editing a memory keyer	4-9
◇ Contest number set mode	4-10
◇ Keyer set mode	4-11
■ Operating RTTY (FSK)	4-13
◇ Convenient functions for receive	4-14
◇ About RTTY reverse mode	4-14
◇ Twin peak filter	4-14
◇ Functions for the RTTY decoder indication	4-15
◇ Setting the decoder threshold level	4-15
◇ RTTY memory transmission	4-16
◇ Automatic transmission/reception setting	4-16
◇ Editing RTTY memory	4-17
◇ RTTY decode set mode	4-18
◇ Data saving	4-20
■ Operating PSK	4-21
◇ Convenient functions for receive	4-22
◇ About BPSK and QPSK modes	4-22
◇ Functions for the PSK decoder indication	4-23
◇ Setting the decoder threshold level	4-23
◇ PSK memory transmission	4-24
◇ Automatic transmission/reception setting	4-24
◇ Editing PSK memory	4-25
◇ PSK decode set mode	4-26
◇ Data saving	4-28
■ Operating AM	4-29
◇ Convenient functions for receive	4-29
◇ Convenient functions for transmit	4-30
■ Operating FM	4-31
◇ Convenient functions for receive	4-31
◇ Convenient functions for transmit	4-31
■ Repeater operation	4-32
◇ Repeater tone frequency setting	4-33
■ Tone squelch operation	4-34
■ Data mode (AFSK) operation	4-35

■ Operating SSB

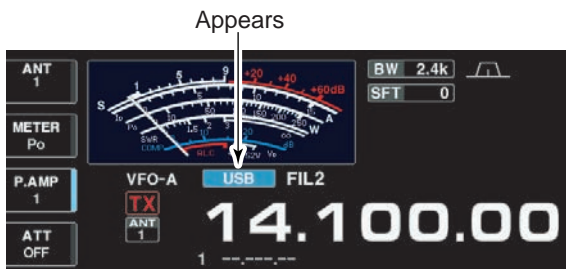
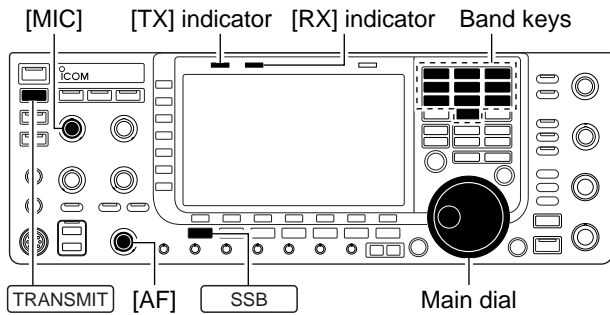

- ① Push a band key to select the desired band.
- ② Push **[SSB]** to select LSB or USB.
 - “USB” or “LSB” appears.
 - Below 10 MHz LSB is automatically selected; above 10 MHz USB is automatically selected.
- ③ Rotate the main dial to tune a desired signal.
 - The S-meter indicates received signal strength when a signal is received.
- ④ Rotate **[AF]** to set audio to a comfortable listening level.
- ⑤ Push **[TRANSMIT]** or **[PTT]** (microphone) to transmit.
 - **[TX]** indicator lights red.
- ⑥ Speak into the microphone at your normal voice level.
 - Adjust the microphone gain with **[MIC]** at this step, if necessary.
- ⑦ Push **[TRANSMIT]** or release **[PTT]** (microphone) to return to receive.

◇ Convenient functions for receive

- **Preamp** (p. 5-9)
 - ➔ Push **[P.AMP]** (MF3) several times to set the preamp OFF, preamp 1 ON or preamp 2 ON.
 - “P.AMP1” or “P.AMP2” appears when the preamp 1 or preamp 2 is ON, respectively.
- **Attenuator** (p. 5-9)
 - ➔ Push **[ATT]** (MF4) several times to set the attenuator in 6 dB steps.
 - Push and hold **[ATT]** (MF4) for 1 sec. to turn the attenuator function OFF.
 - “ATT” and attenuation level appear when the attenuator is ON.
- **Noise blanker** (p. 5-16)
 - ➔ Push **[NB]** to turn the noise blanker ON and OFF, and then rotate **[NB]** control to adjust the threshold level.
 - Noise blanker indicator (above **[NB]** switch) lights when the noise blanker is ON.
 - Push and hold **[NB]** for 1 sec. to enter noise blanker set mode.
- **Twin PBT (passband tuning)** (p. 5-12)
 - ➔ Rotate **[TWIN PBT]** controls (inner/outer).
 - PBT indicator (above **[PBT-CLR]** switch) lights when PBT is in use.
 - Push and hold **[PBT-CLR]** for 1 sec. to clear the settings.
- **Audio tone control** (p. 12-4)
 - ➔ Push **[F-7•SET]** then **[F-1•LEVEL]** to enter level set mode. Select an item with **[F-1•▲]/[F-2•▼]** then rotate the main dial to adjust the audio tone.
- **Noise reduction** (p. 5-17)
 - ➔ Push **[NR]** to turn the noise reduction ON and OFF.
 - Rotate **[NR]** control to adjust the noise reduction level.
 - Noise reduction indicator (above **[NR]** switch) lights when the noise reduction is ON.
- **Notch filter** (p. 5-18)
 - ➔ Push **[NOTCH]** to turn the auto or manual notch function ON and OFF.
 - Rotate **[NOTCH]** control to set the “valley” frequency for manual notch operation.
 - Notch indicator (above **[NOTCH]** switch) lights when either the auto or manual notch is ON.
- **AGC (auto gain control)** (p. 5-11)
 - ➔ Push **[AGC]** (MF5) switch several times to select AGC FAST, AGC MID or AGC SLOW.
 - ➔ Push **[AGC VR]** to turn the AGC time constant manual setting ON and OFF.
 - Rotate **[AGC]** control to adjust the time constant.
- **VSC (voice squelch control)** (p. 9-3)
 - ➔ Push **[VSC]** (MF7) to turn the VSC function ON and OFF.
 - The VSC indicator appears when the voice squelch function is set to ON.

◇ Convenient functions for transmit

- **Speech compressor** (p. 6-5)
 - ➔ Push [COMP] (MF6) to turn the speech compressor ON and OFF.
 - Push and hold [COMP] (MF6) for 1 sec. to select the compression bandwidth from wide, middle and narrow.
- **VOX (voice operated transmit)** (p. 6-2)
 - ➔ Push [VOX] to turn the VOX function ON and OFF.
 - "VOX" appears when the VOX function is ON.
- **Transmit quality monitor** (p. 6-4)
 - ➔ Push [MONITOR] to turn the monitor function ON and OFF.
 - Rotate [MONI GAIN] to adjust the monitor gain.
 - Monitor indicator (above [MONITOR] switch) lights when the monitor function is ON.
- **Audio tone control** (p. 12-5)
 - ➔ Push [F-7•SET] then [F-1•LEVEL] to enter level set mode. Select an item with [F-1•▲]/[F-2•▼] then rotate the main dial to adjust the audio tone.

◇ About 5 MHz band operation (USA version only)

Operation on the 5 MHz band is allowed on 5 discrete frequencies and must adhere to the following:

- USB mode
- Maximum of 50 watts ERP (Effective Radiated Power)
- 2.8 kHz bandwidth

It's your responsibility to set all controls so that transmission in this band meets the stringent conditions under which amateur operations may use these frequencies.

/// **NOTE:** We recommend that you store these frequencies, mode and filter settings into memory channels for easy recall.

/// *The FCC specifies center frequencies on the 5 MHz band. However, the IC-7700 displays carrier frequency. Therefore, tune the transceiver to 1.5 kHz below the specified FCC channel center frequency.

IC-7700 Tuning Frequency*	FCC Channel Center Frequency*
5.33050 MHz	5.33200 MHz
5.34650 MHz	5.34800 MHz
5.36650 MHz	5.36800 MHz
5.37150 MHz	5.37300 MHz
5.40350 MHz	5.40500 MHz

To assist you in operating the 5 MHz band within the rules specified by the FCC, transmission is illegal on any 5 MHz band frequency other than the five frequencies indicated in the table above.

Operating CW

[KEY SPEED] [TX] indicator [RX] indicator Band keys

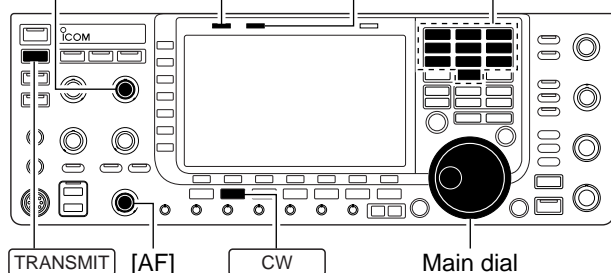

Appears

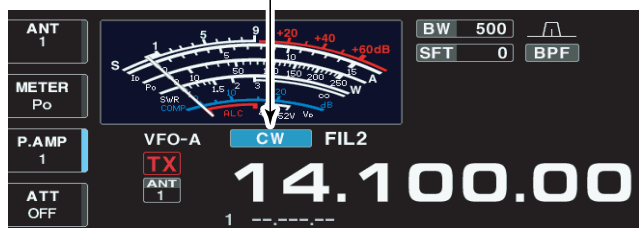

- ① Push a band key to select the desired band.
- ② Push **CW** to select CW.
 - After CW mode is selected, push **CW** to toggle between CW and CW-R modes.
 - “CW” or “CW-R” appears.
- ③ Rotate the main dial to tune a desired signal.
 - Try to match the specified signal's tone to the side tone frequency.
 - The S-meter indicates received signal strength when signal is received.
- ④ Rotate [AF] to set audio to a comfortable listening level.
- ⑤ Push **TRANSMIT** to transmit.
 - [TX] indicator lights red.
- ⑥ Use the electric keyer or paddle to key your CW signals.
 - The power meter indicates transmitted CW output power.
- ⑦ Adjust CW speed with [KEY SPEED].
 - Adjustable within 6–48 WPM.
- ⑧ Push **TRANSMIT** to return to receive.

Convenient functions for receive

- **Preamp** (p. 5-9)
 - ➔ Push [P.AMP] (MF3) several times to set the preamp OFF, preamp 1 ON or preamp 2 ON.
 - “P.AMP1” or “P.AMP2” appears when the preamp 1 or preamp 2 is ON.
- **Attenuator** (p. 5-9)
 - ➔ Push [ATT] (MF4) several times to set the attenuator in 6 dB steps.
 - Push and hold [ATT] (MF4) for 1 sec. to turn the attenuator function OFF.
 - “ATT” and attenuation level appear when the attenuator is ON.
- **Noise blanker** (p. 5-16)
 - ➔ Push **NB** to turn the noise blanker ON and OFF, and then rotate [NB] control to adjust the threshold level.
 - Noise blanker indicator (above **NB** switch) lights when the noise blanker is ON.
 - Push and hold **NB** for 1 sec. to enter noise blanker set mode.
- **Noise reduction** (p. 5-17)
 - ➔ Push **NR** to turn the noise reduction ON and OFF.
 - Rotate [NR] control to adjust the noise reduction level.
 - Noise reduction indicator (above **NR** switch) lights when the noise reduction is ON.
- **Twin PBT (passband tuning)** (p. 5-12)
 - ➔ Rotate [TWIN PBT] controls (inner/outer).
 - PBT indicator (above **PBT-CLR** switch) lights when PBT is in use.
 - Push and hold **PBT-CLR** for 1 sec. to clear the settings.
- **Manual notch filter** (p. 5-18)
 - ➔ Push **NOTCH** to turn the manual notch function ON and OFF.
 - Rotate [NOTCH] control to set the attenuating frequency.
 - Notch indicator (above **NOTCH** switch) lights when the manual notch is ON.
- **AGC (auto gain control)** (p. 5-11)
 - ➔ Push [AGC] switch several times to select AGC FAST, AGC MID or AGC SLOW.
 - ➔ Push **AGC VR** to turn the AGC time constant manual setting ON and OFF.
 - Rotate [AGC] control to adjust the time constant.
- **1/4 function** (p. 3-6)
 - ➔ Push [1/4] to turn the 1/4 function ON and OFF.
- **Auto tuning function** (p. 5-19)
 - ➔ Push [AUTOTUNE] to turn the auto tuning function ON and OFF.
 - The transceiver automatically tunes the desired signal within a ±500 Hz range.

IMPORTANT!

When receiving a weak signal, or receiving a signal with interference, the automatic tuning function may not tune properly, or tune onto an undesired signal.

◇ Convenient functions for transmit

• Break-in function (p. 6-3)

- ➔ Push **[BK-IN]** several times to select the break-in OFF, semi break-in and full break-in.
 - “**BKIN**” or “**F-BKIN**” appears when the semi break-in or full break-in function is ON, respectively.

◇ About CW reverse mode

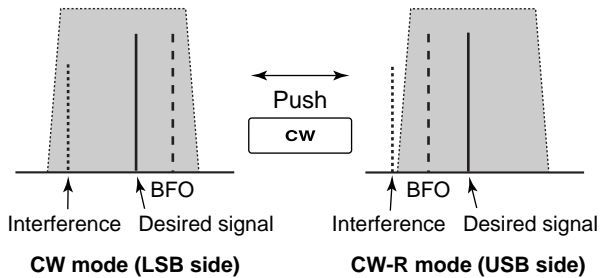

CW-R (CW Reverse) mode uses the opposite side band to receive CW signals.

Use when interfering signals are near a desired signal and you want to use CW-R to reduce the interference.

- ➔ During CW mode, push **[CW]** to select CW and CW-R mode.

◇ About CW pitch control

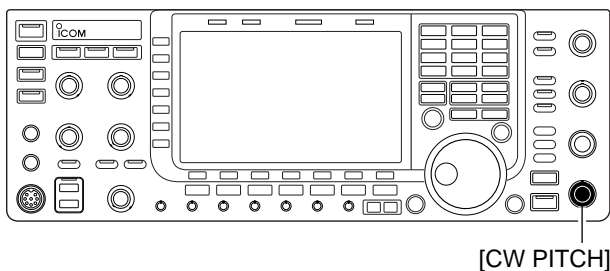

The received CW audio pitch and CW side tone can be adjusted to suit your preference (from 300 to 900 Hz in 5 Hz steps). This does not change the operating frequency.

- ➔ Rotate **[CW PITCH]** to suit your preference.
 - Adjustable within 300 to 900 Hz in 5 Hz steps.

◇ CW side tone function

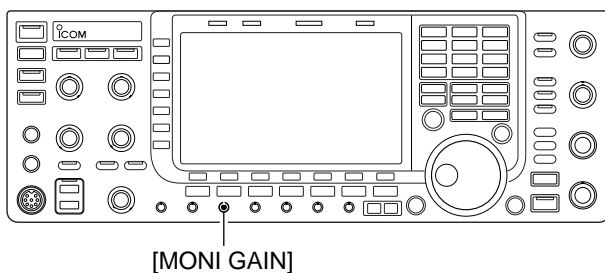

When the transceiver is in receive (and the break-in function is OFF— p. 6-3) you can listen to the CW side tone without actually transmitting.

This allows you to match your transmit frequency exactly to another station's by matching the audio tone. You can also use the CW side tone (be sure to turn OFF break-in!) to practice CW sending. CW side tone level can be adjusted in level set mode (p. 12-6).

◇ APF (Audio Peak Filter) operation

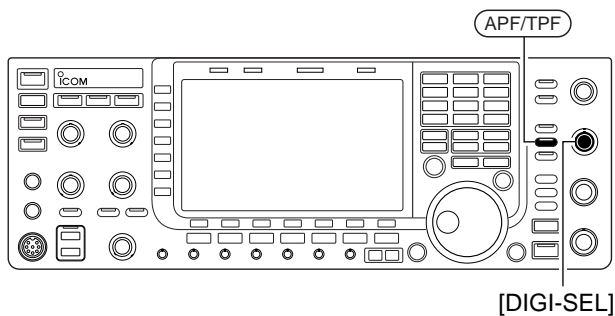

The APF changes the audio frequency response by boosting a particular frequency to enhance a desired CW signal.

The peak frequency can be adjusted with [DIGI-SEL] control when “APF” is selected for “DIGI-SEL VR Operation” in Others set mode (p. 12-16).

The audio filter shape is also selectable from “SOFT” and “SHARP” in Others set mode (p. 12-16).

- ① During CW mode, push **[APF/TPF]** to turn the audio peak filter ON and OFF.
 - “**APF**” appears in the display and [APF/TPF] indicator above this switch lights green.
- ② Push and hold **[APF/TPF]** for 1 sec. several times to select the desired audio filter width.
 - WIDE, MID and NAR filters, or, 320, 160 and 80 Hz filters are available depending on APF type setting in level set mode.
- ③ If “APF” is selected for “DIGI-SEL VR Operation,” rotate [DIGI-SEL] control to suit your preference.

Electronic keyer functions

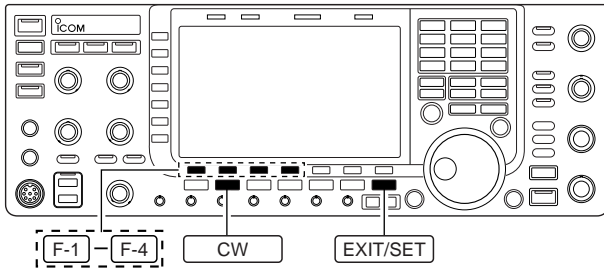

The IC-7700 has a number of convenient functions for the built-in electronic keyer.

- ① During CW mode, push [EXIT/SET] several times to normal screen, if necessary.
- ② Push [F-3•KEYER] to select memory keyer screen.
- ③ Push [EXIT/SET] to select memory keyer menu screen.
- ④ Push one of the LCD function switches ([F-1] to [F-4]) to select the desired menu. See the diagram below.
 - Push [EXIT/SET] to return to the previous display.



• Memory keyer screen (p. 4-8)

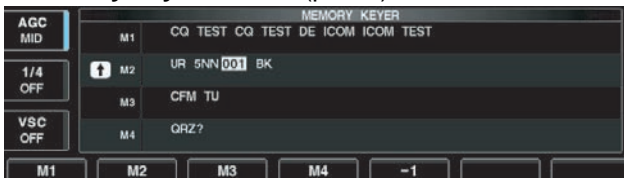

• Memory keyer edit screen (p. 4-9)

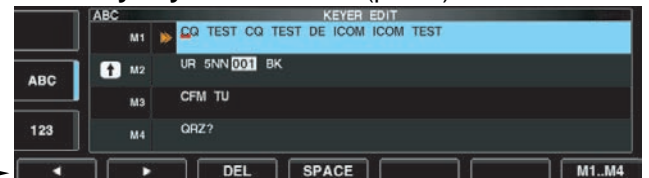

• Memory keyer menu screen

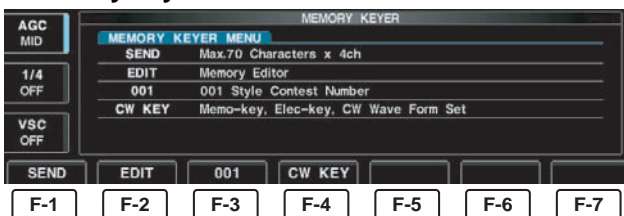

• Contest number set mode (p. 4-10)



• Keyer set mode screen (p. 4-11)



◇ Memory keyer screen

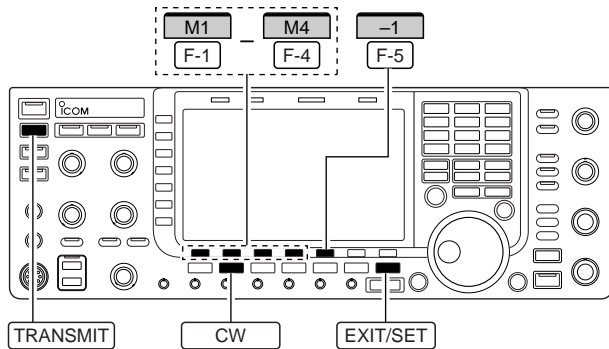

• Memory keyer screen



Pre-set characters can be sent using the keyer send menu. Contents of the memory keyer are set using the edit menu.

• Transmitting

- ① During CW mode operation, push [F-3•KEYER] to select memory keyer screen.
- ② Push [TRANSMIT] to set the transceiver to transmit, or set the break-in function ON (p. 6-3).
- ③ Push one of the function keys ([F-1•M1] to [F-4•M4]) to send the contents of the memory keyer.
 - Pushing and holding a function key for 1 sec. repeatedly sends the contents; push any function key to cancel the transmission.
 - The contest serial number counter is incremented each time the contents are sent.
 - Push [F-5•-1] to reduce the contest serial number count by 1 when resending contents to unanswered calls.

/// For your information

When an external keypad is connected to [EXT KEYPAD] connector on the rear panel, the programmed contents, M1—M4, can be transmitted without selecting the memory keyer screen. See p. 2-7 for details.

- ④ Push [EXIT/SET] twice to return to normal screen.

◇ Editing a memory keyer

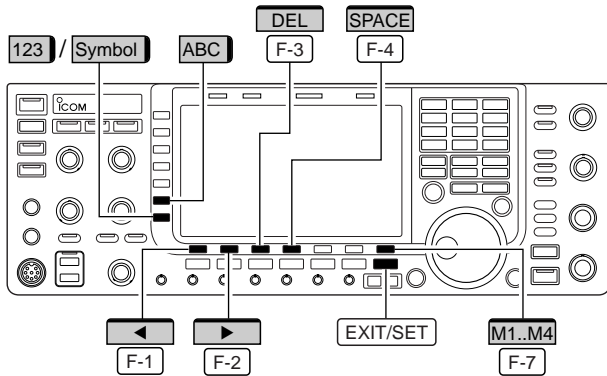

• Memory keyer edit screen



• Example— entered “QSL TU DE JA3YUA TEST” into memory keyer channel 3



• Pre-programmed contents

CH	Contents
M1	CQ TEST CQ TEST DE ICOM ICOM TEST
M2	UR 5NN* BK
M3	CFM TU
M4	QRZ?

The contents of the memory keyer memories can be set using the memory keyer edit menu. The memory keyer can memorize and re-transmit 4 CW key codes for often-used CW sentences, contest serial numbers, etc. Total capacity of the memory keyer is 70 characters per memory channel.

• Programming contents

- ① During CW mode operation, push **KEYER** **F-3** to select memory keyer screen.
- ② Push **EXIT/SET** to select memory keyer menu, then push **EDIT** **F-2** to select keyer edit screen.
 - Memory keyer contents of Channel 1 (M1) is selected.
- ③ Push **M1..M4** **F-7** several times to select the desired memory keyer channel to be edited.
- ④ Push **ABC** (MF6) or **123** (MF7) or **Symbol** (MF7) to select the character group, then rotate the main dial to select the character, or push the keypad for number input.
 - [Symbol] appears when **123** (MF7) is pushed when “123” character group is selected.
 - Selectable characters (using the main dial);

Key selection	Editable characters
ABC	A to Z (capital letters)
123	0 to 9 (numbers)
Symbol	/ ? ^ . , @ *

NOTE:

“^” is used to transmit a following word with no space such as AR. Put “^” before a text string such as ^AR, and the string “AR” is sent with no space.
 “*” is used to insert the CW contest serial number. The serial number automatically increments by 1. This function is only available for one memory keyer channel at a time. Memory keyer channel M2 used “*” by default.

✓ For your convenience

When a PC keyboard is connected to [USB] connector on the front panel, the memory keyer contents can also be edited from the keyboard.

- ⑤ Push **◀** **F-1** or **▶** **F-2** to move the cursor backwards or forwards, respectively.
 - Pushing **DEL** **F-3** deletes a character and **SPACE** **F-4** inserts a space.
- ⑥ Repeat steps ④ and ⑤ to input the desired characters.
- ⑦ Push **EXIT/SET** twice to return normal screen.

◇ Contest number set mode

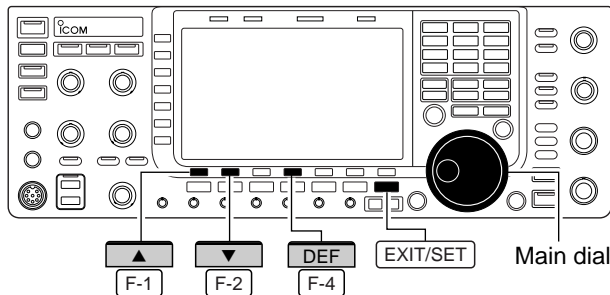

• Contest number set mode screen



This menu is used to set the contest (serial) number and count-up trigger, etc.

• Setting contents

- ① During CW mode operation, push [F-3•KEYER] to select memory keyer screen.
- ② Push [EXIT/SET] to select memory keyer menu, then push [F-3•001] to select contest serial number set mode.
- ③ Push [F-1•▲] or [F-2•▼] to select the desired set item.
- ④ Set the desired condition using the main dial.
 - Push and hold [F-4•DEF] for 1 sec. to select the default condition or value.
- ⑤ Push [EXIT/SET] twice to normal screen.

Number Style

This item sets the numbering system used for contest (serial) numbers— normal or short morse numbers.

Normal

- Normal : Does not use short morse numbers (default)
- 190→ANO : Sets 1 as A, 9 as N and 0 as O.
- 190→ANT : Sets 1 as A, 9 as N and 0 as T.
- 90→ NO : Sets 9 as N and 0 as O.
- 90→ NT : Sets 9 as N and 0 as T.

Count Up Trigger

This selects which of the four memories will contain the contest serial number exchange. The count-up trigger allows the serial number to automatically increment after each complete serial number exchange is sent.

M2

- M1, M2, M3 and M4 can be set. (default: M2)

Present Number

This item shows the current number for the count-up trigger channel set above.

001

- Rotate the main dial to change the number, or push and hold [F-3•001CLR] for 1 sec. to reset the current number to 001.

◇ Keyer set mode

This set mode is used to set the memory keyer repeat time, dash weight, paddle specifications, keyer type, etc.

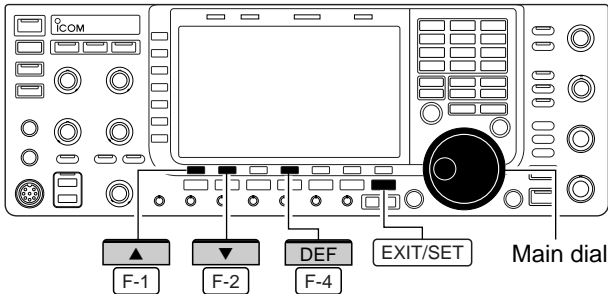

• Setting contents

- ① During CW mode operation, push [F-3•KEYER] to select memory keyer screen.
- ② Push [EXIT/SET] to select memory keyer menu, then push [F-4•CW KEY] to select keyer set mode.
- ③ Push [F-1•▲] or [F-2•▼] to select the desired set item.
- ④ Set the desired condition using the main dial.
 - Push and hold [F-4•DEF] for 1 sec. to select the default condition or value.
- ⑤ Push [EXIT/SET] twice to normal screen.

• Keyer set mode screen



Keyer Repeat Time

2s

When sending CW using the repeat timer, this item sets the time between transmission.

- 1 to 60 sec. in 1 sec. steps can be selected. (default: 2 sec.)

Dot/Dash Ratio

1:1:3.0

This item sets the dot/dash ratio.

- 1:1:2.8 to 1:1:4.5 (in 0.1 steps) can be selected. (default: 1:1:3.0)

Keying weight example: Morse code "K"

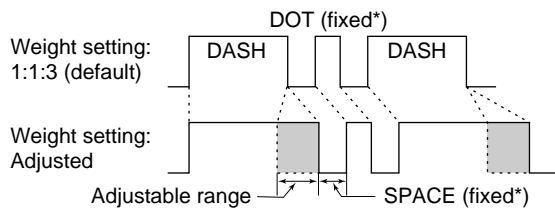

*SPACE and DOT length can be adjusted with [KEY SPEED] only.

Rise Time

4ms

This item sets the rise time of the transmitted CW envelope.

- 2, 4, 6 or 8 msec. can be selected. (default: 4 msec.)

• About rise time

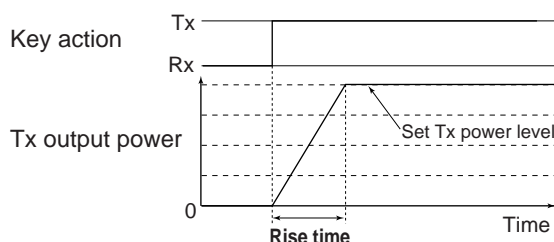

to be continued...

◇ Keyer set mode (continued)

Paddle Polarity	Normal
This item sets the paddle polarity.	• Normal and reverse polarity can be selected.

Keyer Type	ELE-KEY
This item selects the keyer type for [ELEC-KEY] connector on the front panel.	• ELEC-KEY, BUG-KEY and Straight key can be selected. (default: ELEC-KEY)

Mic Up/Down Keyer	OFF
This item allows you to set the microphone [UP]/[DN] keys to be used as a paddle.	<ul style="list-style-type: none">• ON : [UP]/[DN] switches can be used for CW.• OFF : [UP]/[DN] switches cannot be used for CW. <p>NOTE: When “ON” is selected, the frequency and memory channel cannot be changed using the [UP]/[DN] switches.</p>

■ Operating RTTY (FSK)

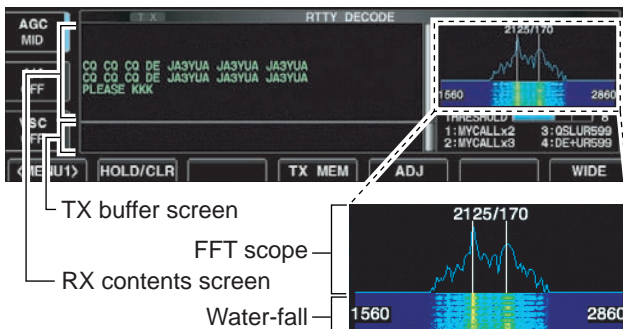
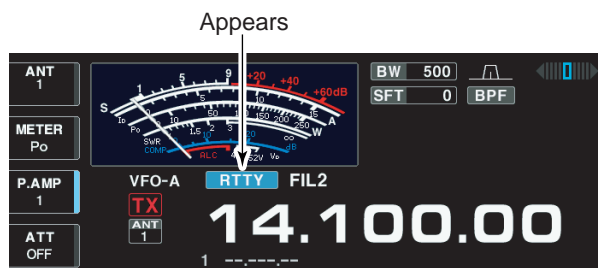
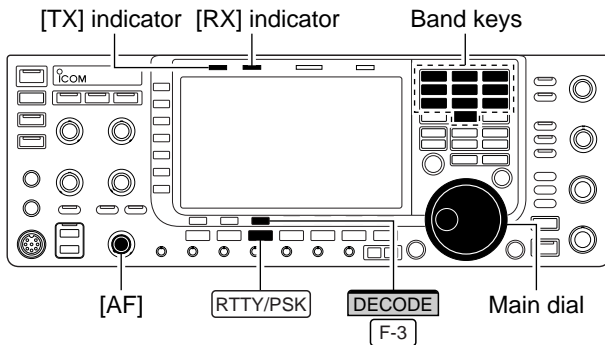

A DSP-based high-quality Baudot RTTY encoder/decoder is built-in to the IC-7700. When connecting a PC keyboard (p. 2-6), RTTY operation can be performed without an external RTTY terminal, TNC or PC.

If you would rather use your RTTY terminal or TNC, consult the manual that comes with the RTTY terminal or TNC.

- ① Push a band key to select the desired band.
- ② Push **[RTTY/PSK]** to select RTTY.
 - After RTTY mode is selected, push and hold **[RTTY/PSK]** for 1 sec. to toggle between RTTY and RTTY-R modes.
 - “RTTY” or “RTTY-R” appears.
- ③ Push **[F-3•DECODE]** to display the decode screen.
 - The IC-7700 has a built-in Baudot decoder.
- ④ To tune the desired signal, aim for a symmetrical waveform and ensure the peak points align with the mark (2125 Hz) and shift (170 Hz) frequency lines in the FFT scope.
 - The S-meter indicates received signal strength when signal is received.
- ⑤ Press **[F12]** on the connected keyboard to transmit.
 - [TX] indicator lights red.
- ⑥ Type from the keyboard to enter the contents that you want to transmit.
 - The typewritten contents are indicated in the TX buffer screen and transmitted immediately.
 - The text color will be changed when transmitted.
 - Press one of **[F1]–[F8]** to transmit the TX memory contents.
- ⑦ Press **[F12]** on the keyboard to return to receive.

✓ For your convenience

The transmission contents can be typed before being transmitted.

- ① Perform the steps ① to ④ above.
- ② Type from the connected keyboard to enter the message that you want to transmit.
 - The typewritten contents are indicated in the TX buffer screen.
- ③ Press **[F12]** of the connected keyboard to transmit the typewritten contents.
 - The color of displayed text, in the TX buffer screen, will be changed when transmitted.
 - To cancel the transmission, press **[F12]** twice.
- ④ Press **[F12]** of the keyboard to return to receive.

◆ Convenient functions for receive

- **Preamp** (p. 5-9)
 - ➔ Push [P.AMP] (MF3) several times to set the preamp OFF, preamp 1 ON or preamp 2 ON.
 - “P.AMP1” or “P.AMP2” appears when the preamp 1 or preamp 2 is ON.
- **Attenuator** (p. 5-9)
 - ➔ Push [ATT] (MF4) several times to set the attenuator in 6 dB steps.
 - Push and hold [ATT] (MF4) for 1 sec. to turn the attenuator function OFF.
 - “ATT” and attenuation level appear when the attenuator is ON.
- **Noise blanker** (p. 5-16)
 - ➔ Push [NB] to turn the noise blanker ON and OFF, and then rotate [NB] control to adjust the threshold level.
 - Noise blanker indicator (above [NB] switch) lights when the noise blanker is ON.
 - Push and hold [NB] for 1 sec. to enter noise blanker set mode.
- **Twin PBT (passband tuning)** (p. 5-12)
 - ➔ Rotate [TWIN PBT] controls (inner/outer).
 - PBT indicator (above [PBT-CLR] switch) lights when PBT is in use.
 - Push and hold [PBT-CLR] for 1 sec. to clear the settings.
- **Noise reduction** (p. 5-17)
 - ➔ Push [NR] to turn the noise reduction ON and OFF.
 - Rotate [NR] control to adjust the noise reduction level.
 - Noise reduction indicator (above [NR] switch) lights when the noise reduction is ON.
- **Manual notch filter** (p. 5-18)
 - ➔ Push [NOTCH] to turn the manual notch function ON and OFF.
 - Rotate [NOTCH] control to set the attenuating frequency.
 - Notch indicator (above [NOTCH] switch) lights when the manual notch is ON.
- **AGC (auto gain control)** (p. 5-11)
 - ➔ Push [AGC] switch several times to select AGC FAST, AGC MID or AGC SLOW.
 - ➔ Push [AGC VR] to turn the AGC time constant manual setting ON and OFF.
 - Rotate [AGC] control to adjust the time constant.
- **1/4 function** (p. 3-6)
 - ➔ Push [1/4] to turn the 1/4 function ON and OFF.

◆ About RTTY reverse mode

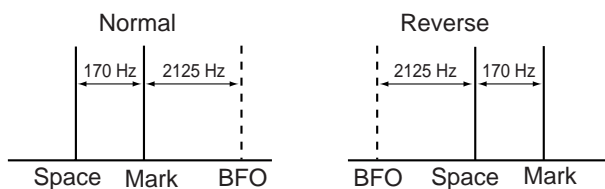

Received characters are occasionally garbled when the received signal has Mark and Space tones reversed. This reversal can be caused by incorrect TNC connections, setting, commands, etc. To receive reversed RTTY signals correctly, select RTTY-R mode.

- ➔ During RTTY mode, push and hold [RTTY/PSK] for 1 sec. to select RTTY and RTTY-R mode.

◆ Twin peak filter

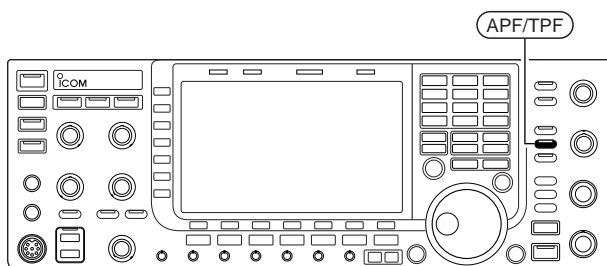

The twin peak filter changes audio frequency response by boosting the mark and space frequencies (2125 and 2295 Hz) for better reception of RTTY signals.

- ➔ During RTTY mode, push [APF/TPF] to turn the twin peak filter ON and OFF.
 - “TPF” appears in the LCD and the [APF/TPF] indicator above this switch lights green while the filter is in use.

NOTE: When the twin peak filter is in use, the received audio output may increase. This is a normal, not a malfunction.

◆ Functions for the RTTY decoder indication

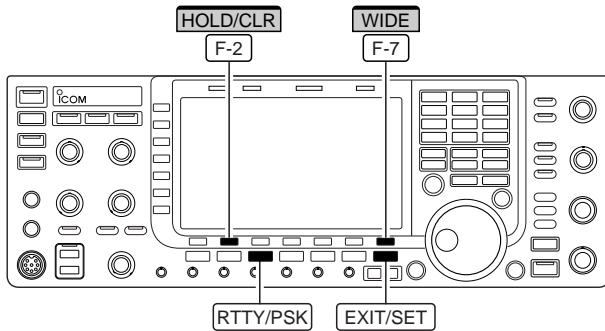

• Wide screen indication



◆ Setting the decoder threshold level



- ① Push a band key to select the desired band.
- ② Push [RTTY/PSK] to select RTTY.
 - After RTTY mode is selected, push and hold [RTTY/PSK] for 1 sec. to toggle between RTTY and RTTY-R modes.
 - "RTTY" or "RTTY-R" appears.
- ③ Push [F-3•DECODE] to display the decode screen.
 - When tuned into an RTTY signal, decoded characters are displayed in the RX contents screen.
- ④ Push [F-2•HOLD/CLR] to freeze the current screen.
 - "HOLD" appears while the function is in use.
 - Push [F-2•HOLD/CLR] again to release the function.
- ⑤ Push and hold [F-2•HOLD/CLR] for 1 sec. to clear the displayed characters.
 - "HOLD" indicator disappears at the same time when the hold function is in use.
- ⑥ Push [F-7•WIDE] to toggle the RTTY decode screen size from normal and wide.
 - S/R/F meter type during wide screen indication can be selected in display set mode. (pgs. 3-11, 12-10)
- ⑦ Push [EXIT/SET] to close the RTTY decode screen.

Adjust the RTTY decoder threshold level if some characters are displayed when no signal is received.

- ① Select the RTTY decode screen as described above.
- ② Push [F-5•ADJ] to select the threshold level setting condition.
- ③ Rotate the main dial to adjust the RTTY decoder threshold level.
 - Push and hold [F-6•DEF] for 1 sec. to select the default setting.
- ④ Push [F-5•ADJ] to exit from the threshold level setting condition.

▨ The UnShift On Space (USOS) function and new line code can be set in the RTTY set mode. (p. 4-18)

◇ RTTY memory transmission

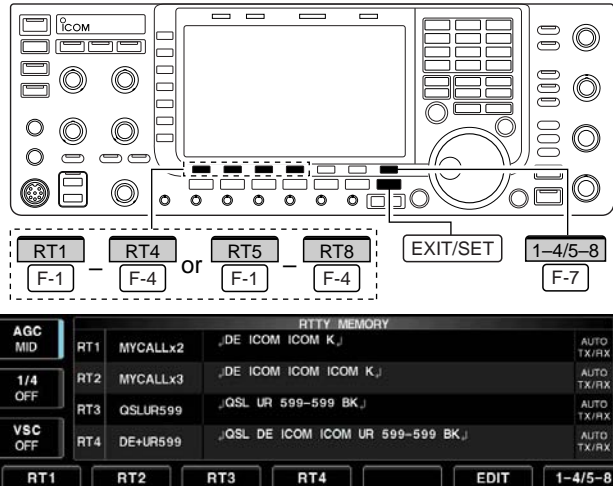

Pre-set characters can be sent using the RTTY memory. Contents of the memory are set using the edit menu.

- ① During RTTY mode operation, push [F-3•DECODE] to select RTTY decode screen.
- ② Push [F-4•TX MEM] to select RTTY memory screen.
- ③ Push [F-7•1-4/5-8] to select memory bank then push one of the function keys ([F-1•RT1] to [F-4•RT4] or [F-1•RT5] to [F-4•RT8]).
 - When no keyboard is connected, the selected memory contents will be transmitted immediately.
 - When a keyboard is connected, the memory contents will be transmitted immediately when function key is pushed, or transmitted after [F12] on the connected keyboard is pressed, depending on auto transmission/reception setting (see below).
 - The transmission date, time, reception date and/or time may be displayed in RX contents screen, depending on setting.

◇ Automatic transmission/reception setting

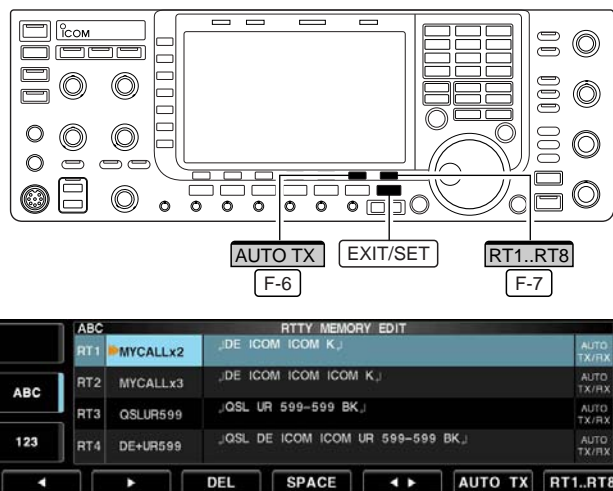

- ① During RTTY mode operation, push [F-3•DECODE] to select RTTY decode screen.
- ② Push [F-4•TX MEM] to select RTTY memory screen, then push [F-6•EDIT] to select RTTY memory edit screen.
 - RTTY memory contents of the Channel 1 (RT1) is selected.
- ③ Push [F-7•RT1..RT8] several times to select the desired RTTY memory.
- ④ Push [F-6•AUTO TX] several times to select the desired condition as follow.
 - **AUTO TX/RX** : Automatically transmits the selected memory and returns to receive after the transmission.
 - **AUTO TX** : Automatically transmits the selected memory. To return to receive, press [F12] on the keyboard.
 - **AUTO RX** : Press [F12] on the keyboard to transmit the selected memory. Automatically returns to receive after the transmission.
 - **No indication** : Press [F12] on the keyboard to transmit the selected memory and press [F12] again to return to receive.
- ⑤ Push [EXIT/SET] to exit RTTY memory edit condition.

NOTE: The transceiver always functions in the “AUTO TX/RX” setting when no keyboard is connected.

◇ Editing RTTY memory

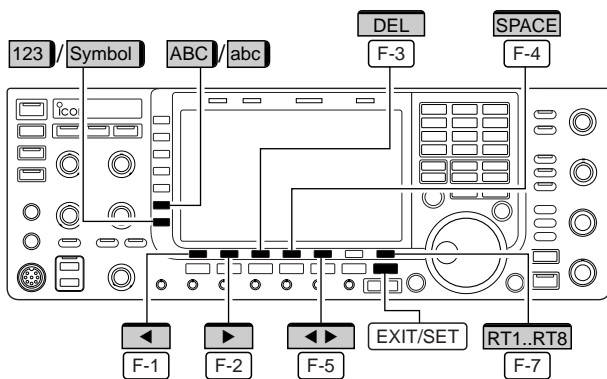

• RTTY memory edit screen



• Pre-programmed contents

CH	Name	Contents
RT1	MYCALLx2	◀DE ICOM ICOM K▶
RT2	MYCALLx3	◀DE ICOM ICOM ICOM K▶
RT3	QSLUR599	◀QSL UR 599-599 BK▶
RT4	DE+UR599	◀QSL DE ICOM ICOM UR 599-599 BK▶
RT5	73 GL SK	◀73 GL SK▶
RT6	CQ CQ CQ	◀CQ CQ CQ DE ICOM ICOM ICOM K▶
RT7	RIG&ANT	◀MY TRANSCEIVER IS IC-7700 & ANTENNA IS A 3-ELEMENT TRIBAND YAGI.▶
RT8	EQUIP.	◀MY RTTY EQUIPMENT IS INTERNAL FSK UNIT & DEMODULATOR OF THE IC-7700.▶

The contents of the RTTY memories can be set using the memory edit menu. The memory can store and re-transmit 8 RTTY message for often-used RTTY information. Total capacity of the memory is 70 characters per memory channel.

• Programming contents

- ① During RTTY mode operation, push [F-3•DECODE] to select RTTY decode screen.
- ② Push [F-4•TX MEM] to select RTTY memory screen, then push [F-6•EDIT] to select RTTY memory edit screen.
 - RTTY memory contents of the Channel 1 (RT1) is selected.
- ③ Push [F-7•RT1..RT8] to several times to select the desired RTTY memory channel to be edited.
- ④ Push [F-5•◀ ▶] to select the edit item between memory contents and memory name.
- ⑤ Push [ABC] (MF6), [abc] (MF6), [123] (MF7) or [Symbol] (MF7) to select the character group, then rotate the main dial to select the character, or push the keypad for number input.

- [abc] (MF6) appears when [ABC] (MF6) is pushed when "ABC" character group is selected, and [Symbol] (MF7) appears when [123] (MF7) is pushed when "123" character group is selected.
- Selectable characters (with the main dial);

Key selection	Editable characters
ABC	A to Z (capital letters)
abc	a to z (small letters) (selectable for memory name only)
123	0 to 9 (numbers)
Symbol	! # \$ % & ¥ ? " ' ^ + - * / . , ; = < > () [] { } _ ~ @ (For the memory contents setting, ! \$ & ? " ' - / . , ; () ▶ are selectable.)

✓ For your convenience

When a PC keyboard is connected to [USB] connector on the front panel, the RTTY memory contents can also be edited from the keyboard.

- ⑥ Push [F-1•◀] or [F-2•▶] to move the cursor backwards or forwards, respectively.
 - Pushing [F-3•DEL] deletes a character and [F-4•SPACE] inserts a space.
- ⑦ Repeat steps ⑤ and ⑥ to input the desired characters.
- ⑧ Push [EXIT/SET] to set the contents and exit RTTY memory edit screen.

4 RECEIVE AND TRANSMIT

◇ RTTY decode set mode

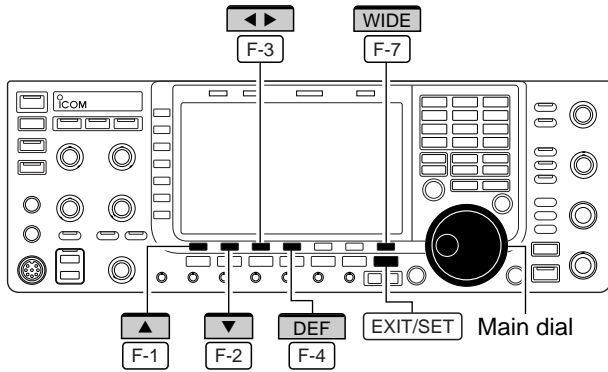

• RTTY decode set mode screen



This set mode is used to set the decode USOS function, time stamp setting, etc.

• Setting contents

- ① During RTTY mode operation, push [F-3•DECODE] to select RTTY decode screen.
- ② Push [F-1•<MENU1>] to select the second RTTY decode menu, then push [F-6•SET] to select RTTY decode set mode.
 - Push [F-7•WIDE] to toggle the screen size from normal and wide.
- ③ Push [F-1•▲] or [F-2•▼] to select the desired set item.
- ④ Set the desired condition using the main dial.
 - Push and hold [F-4•DEF] for 1 sec. to select a default condition or value.
 - Push [F-3•◀ ▶] to select the set contents for some items.
- ⑤ Push [EXIT/SET] to exit from set mode.

RTTY FFT Scope Averaging

OFF

Select the FFT scope waveform averaging function from 2 to 4 and OFF. (default: OFF)

Recommendation!

If you use the FFT scope waveform for tuning, use the default or smaller number setting is recommended.

RTTY FFT Scope Waveform Color

51 153 255

Set the color for the FFT scope waveform.

- The color is set in RGB format.
- The set color is indicated in the box beside the RGB scale.

- Push [F-3•◀ ▶] to select R (Red), G (Green) and B (Blue), and then rotate the main dial to set the ratio from 0 to 255.

RTTY Decode USOS

ON

Turn the capability of letter code decoding after receiving a "space" (USOS; UnShift On Space function) ON and OFF.

- ON : Decode as letter code.
- OFF : Decode as character code.

RTTY Decode New Line Code

CR,LF,CR+LF

Selects the new line code of the internal RTTY decoder.

CR: Carriage Return, LF: Line Feed

- CR,LF,CR+LF : Makes new line with any codes.
- CR+LF : Makes new line with CR+LF code only.

RTTY Diddle

BLANK

Selects the diddle condition.

- BLANK : Transmits blank code during no code transmission.
- LTRS : Transmits letter code during no code transmission.
- OFF : Turns the diddle function OFF.

◇ RTTY decode set mode (continued)

<p>RTTY TX USOS</p> <p>Explicitly inserts the FIGS character even though it is not required by the receiving station.</p>	<p>ON</p> <ul style="list-style-type: none"> • ON : Inserts FIGS. • OFF : Does not insert FIGS.
<p>RTTY Time Stamp</p> <p>Turn the time stamp (date, transmission or reception time) indication ON and OFF.</p>	<p>ON</p> <ul style="list-style-type: none"> • ON : Displays the time stamp. • OFF : No time stamp indication.
<p>RTTY Auto CR+LF by TX</p> <p>Selects the automatic new line code (CR+LF) transmission capability.</p>	<p>ON</p> <ul style="list-style-type: none"> • ON : Transmits CR+LF code once. • OFF : Transmits no CR+LF code.
<p>RTTY Time Stamp (Time)</p> <p>Selects the clock indication for time stamp usage.</p> <p>NOTE: The time won't be displayed when "OFF" is selected in "RTTY Time Stamp" as above.</p>	<p>Local</p> <ul style="list-style-type: none"> • Local : Selects the time that set in "Time (Now)." • UTC* : Selects the time that set in "CLOCK2." <p>*The name of choice may differ according to "CLOCK2 Name" setting (p. 11-2). "UTC" is the default name of CLOCK2.</p>
<p>RTTY Time Stamp (Frequency)</p> <p>Selects the operating frequency indication for time stamp usage.</p> <p>NOTE: The frequency won't be displayed when "OFF" is selected in "RTTY Time Stamp" as above.</p>	<p>OFF</p> <ul style="list-style-type: none"> • ON : Displays the operating frequency. • OFF : No operating frequency display.
<p>RTTY Font Color (Receive)</p> <p>Set the text color for received characters.</p> <ul style="list-style-type: none"> • The color is set in RGB format. • The set color is indicated in the box beside the RGB scale. 	<ul style="list-style-type: none"> • Push [F-3◀▶] to select R (Red), G (Green) and B (Blue), and then rotate the main dial to set the ratio from 0 to 255.
<p>RTTY Font Color (Transmit)</p> <p>Set the text color for transmitted characters.</p> <ul style="list-style-type: none"> • The color is set in RGB format. • The set color is indicated in the box beside the RGB scale. 	<ul style="list-style-type: none"> • Push [F-3◀▶] to select R (Red), G (Green) and B (Blue), and then rotate the main dial to set the ratio from 0 to 255.
<p>RTTY Font Color (Time Stamp)</p> <p>Set the text color for time stamp indication.</p> <ul style="list-style-type: none"> • The color is set in RGB format. • The set color is indicated in the box beside the RGB scale. 	<ul style="list-style-type: none"> • Push [F-3◀▶] to select R (Red), G (Green) and B (Blue), and then rotate the main dial to set the ratio from 0 to 255.
<p>RTTY Font Color (TX Buffer)</p> <p>Set the text color in the TX buffer screen.</p> <ul style="list-style-type: none"> • The color is set in RGB format. • The set color is indicated in the box beside the RGB scale. 	<ul style="list-style-type: none"> • Push [F-3◀▶] to select R (Red), G (Green) and B (Blue), and then rotate the main dial to set the ratio from 0 to 255.

◇ Data saving

The USB-Memory is not supplied by Icom.

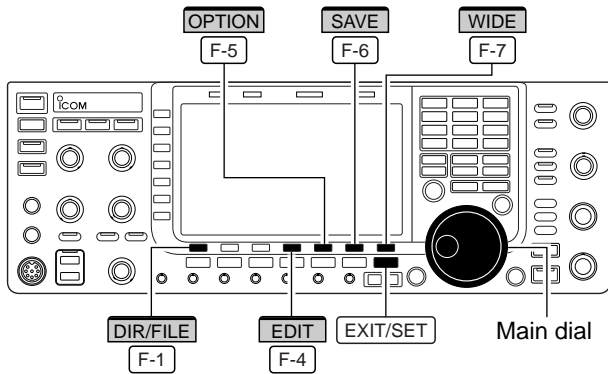

• Decode file save screen



• Decode file save screen— file name edit

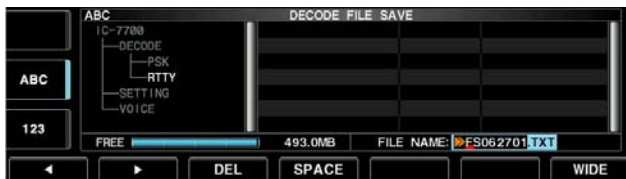

• Save option screen

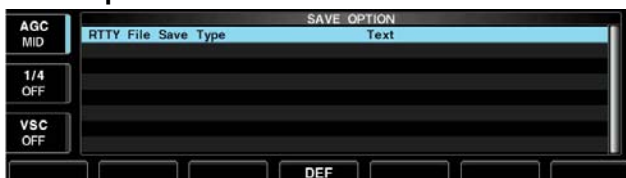

The contents of the RTTY memory and received signal can be saved into the USB-Memory.

- ① During RTTY decode screen indication, push [F-1•<MENU1>] to select the RTTY decode second menu.
- ② Push [F-5•SAVE] to select decode file save screen.
- ③ Change the following conditions if desired.

• File name:

- ① Push [F-4•EDIT] to select file name edit condition.
 - Push [F-1•DIR/FILE] several times to select the file name, if necessary.
- ② Push [ABC] (MF6), [123] or [Symbol] (MF7) to select the character group, then rotate the main dial to select the character.
 - [ABC] (MF6): A to Z (capital letters); [123] (MF7): 0 to 9 (numerals); [Symbol] (MF7): ! # \$ % & ' ` ^ + - = () [] { } _ ~ @ can be selected.
 - Push [F-1•◀] to move the cursor left, push [F-2•▶] to move the cursor right, [F-3•DEL] delete a character and push [F-4•SPACE] to insert a space.
- ③ Push [EXIT/SET] to set the file name.

• File format

- ① Push [F-5•OPTION] to enter save option screen.
- ② Rotate the main dial to select the saving format from Text to HTML.
 - “Text” is the default setting.
 - Push and hold [F-4•DEF] for 1 sec. to select the default setting.
- ③ Push [EXIT/SET] to return to the previous indication.

• Saving location

- ① Push [F-1•DIR/FILE] to select tree view screen.
- ② Select the desired directory or folder in the USB-Memory.
 - Push [F-4•◀ ▶] to select the upper directory.
 - Push [F-2•▲] or [F-3•▼] to select folder in the same directory.
 - Push and hold [F-4•◀ ▶] for 1 sec. to select a folder in the directory.
 - Push [F-5•REN/DEL] to rename the folder.
 - Push and hold [F-5•REN/DEL] for 1 sec. to delete the folder.
 - Push and hold [F-6•MAKE] for 1 sec. to making a new folder. (Edit the name with the same manner as the “• File name” above.)
- ③ Push [F-1•DIR/FILE] twice to select the file name.

- ④ Push [F-6•SAVE].
 - After saving is completed, returns to RTTY decode second menu automatically.

✓ For your convenience!

Two formats, Text and HTML, are available for storage of data to your PC.

Operating PSK

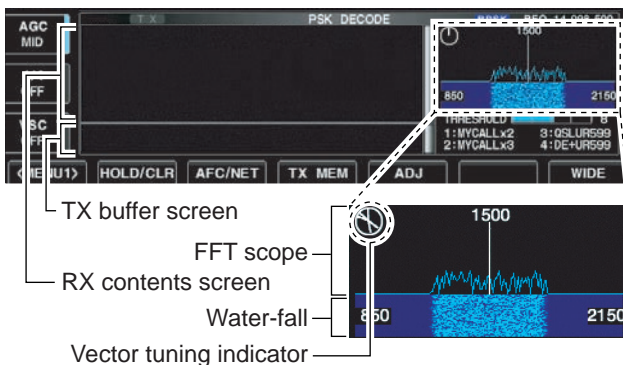
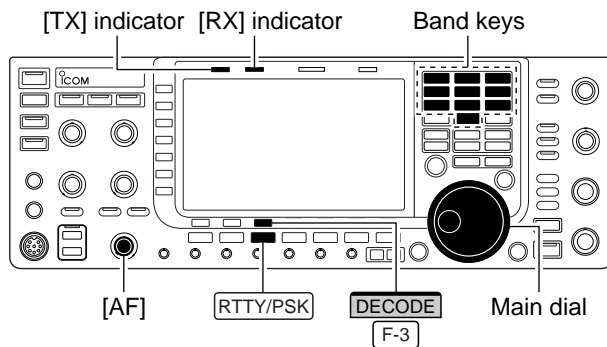

• Vector tuning indicator indication example

Tuned BPSK signal Tuned QPSK signal



BPSK/QPSK idle signal Unmodulated signal



A high-quality DSP-based PSK31 encoder/decoder is built-in to the IC-7700. When connecting a PC keyboard (p. 2-6), PSK31 operation can be performed without PSK software installed on your PC.

If desired, you can also use your PSK software; consult the manual that comes with the software.

- ① Push a band key to select the desired band.
- ② Push **[RTTY/PSK]** to select PSK.
 - After PSK mode is selected, push and hold **[RTTY/PSK]** for 1 sec. to toggle between PSK and PSK-R modes.
 - "PSK" or "PSK-R" appears.
- ③ Push **[F-3•DECODE]** to display the decode screen.
 - The IC-7700 has a built-in PSK31 decoder.
- ④ Tune to the desired signal with the main dial.
 - The signal is properly tuned when the radiated lines in the vector tuning indicator narrow, as show in the example below.
 - The radiated lines in the vector tuning indicator may be displayed sporadically.
 - When a PSK signal is received, the water-fall display is activated.
 - The water-fall display shows the signal condition within the passband and a vertical line appears when a PSK signal is received.
- ⑤ Press **[F12]** of the connected keyboard to transmit.
 - **[TX]** indicator lights red.
- ⑥ Type from the connected keyboard to enter the message that you want to transmit.
 - The typewritten contents are indicated in the TX buffer screen and transmitted immediately.
 - The text color will be changed when transmitted.
 - Press one of **[F1]–[F8]** to transmit the TX memory contents.
- ⑦ Press **[F12]** of the keyboard to return to receive.

✓ For your convenience

The transmission contents can be typed before being transmitted.

- ① Perform the steps ① to ④ above.
- ② Type from the connected keyboard to enter the message that you want to transmit.
 - The message is shown in the TX buffer screen.
- ③ Press **[F12]** of the connected keyboard to transmit the message.
 - The color of displayed text, in the TX buffer screen, will be changed when transmitted.
 - To cancel the transmission, press **[F12]** twice.
- ④ Press **[F12]** of the keyboard to return to receive.

◆ Convenient functions for receive

- **Preamp** (p. 5-9)
 - ➔ Push [P.AMP] (MF3) several times to set the preamp OFF, preamp 1 ON or preamp 2 ON.
 - “P.AMP1” or “P.AMP2” appears when the preamp 1 or preamp 2 is ON.
- **Attenuator** (p. 5-9)
 - ➔ Push [ATT] (MF4) several times to set the attenuator in 6 dB steps.
 - Push and hold [ATT] (MF4) for 1 sec. to turn the attenuator function OFF.
 - “ATT” and attenuation level appear when the attenuator is ON.
- **Noise blanker** (p. 5-16)
 - ➔ Push [NB] to turn the noise blanker ON and OFF, and then rotate [NB] control to adjust the threshold level.
 - Noise blanker indicator (above [NB] switch) lights when the noise blanker is ON.
 - Push and hold [NB] for 1 sec. to enter noise blanker set mode.
- **Noise reduction** (p. 5-17)
 - ➔ Push [NR] to turn the noise reduction ON and OFF.
 - Rotate [NR] control to adjust the noise reduction level.
 - Noise reduction indicator (above [NR] switch) lights when the noise reduction is ON.
- **Twin PBT (passband tuning)** (p. 5-12)
 - ➔ Rotate [TWIN PBT] controls (inner/outer).
 - PBT indicator (above [PBT-CLR] switch) lights when PBT is in use.
 - Push and hold [PBT-CLR] for 1 sec. to clear the settings.
- **AGC (auto gain control)** (p. 5-11)
 - ➔ Push [AGC] switch several times to select AGC FAST, AGC MID or AGC SLOW.
 - Push [AGC VR] to turn the AGC time constant manual setting ON and OFF.
 - Rotate [AGC] control to adjust the time constant.
- **Manual notch filter** (p. 5-18)
 - ➔ Push [NOTCH] to turn the manual notch function ON and OFF.
 - Rotate [NOTCH] control to set the attenuating frequency.
 - Notch indicator (above [NOTCH] switch) lights when the manual notch is ON.
- **Fine tuning** (p. 3-7)
 - ➔ During PSK, make sure that the kHz tuning step function is OFF (no “▼” indication), push and hold [TS] for 1 sec.
 - PSK may not be decoded correctly using the 10 Hz step tuning.
- **1/4 function** (p. 3-6)
 - ➔ Push [1/4] to turn the 1/4 function ON and OFF.

◆ About BPSK and QPSK modes

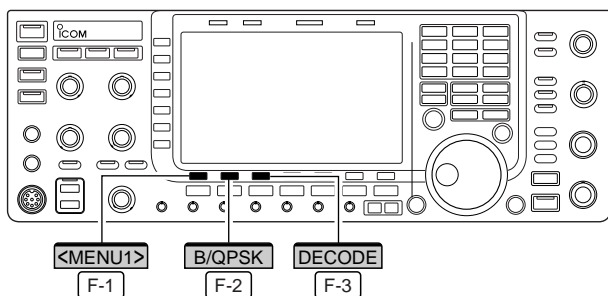

• PSK decode screen— BPSK mode



• PSK decode screen— QPSK mode

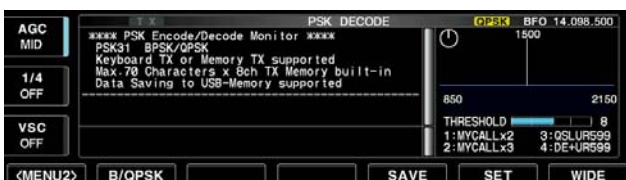

BPSK and QPSK modes are available for PSK31.

- BPSK (Binary Phase Shift Keying) mode is the most commonly used mode.
- QPSK (Quadrature Phase Shift Keying) mode has error correction capability to provide better decoding than BPSK mode in marginal condition. However, more accurate tuning is required with QPSK mode, due to the tight phase margin of QPSK.

- ① During PSK mode selection, push [F-3•DECODE] to display the PSK decode screen.
- ② Push [F-1•<MENU>] to select PSK decode second menu.
- ③ Push [F-2•B/QPSK] to toggle between BPSK and QPSK mode alternately.

◆ Functions for the PSK decoder indication

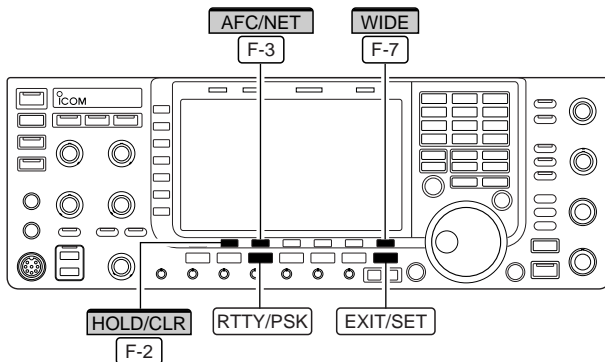

• AFC/NET indications

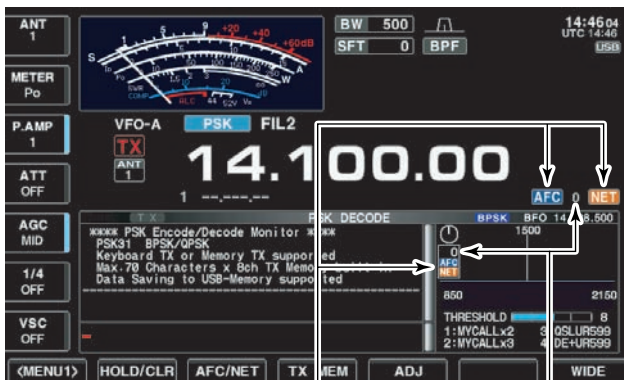

“AFC” and “NET” indicators Offset frequency

- ① Push a band key to select the desired band.
- ② Push **[RTTY/PSK]** to select PSK.
 - After PSK mode is selected, push and hold **[RTTY/PSK]** for 1 sec. to toggle between PSK and PSK-R modes.
 - “PSK” or “PSK-R” appears.
- ③ Push **[F-3•DECODE]** to display the decode screen.
 - When tuned into a PSK signal, decoded characters are displayed in the RX contents screen.
- ④ Push **[F-2•HOLD/CLR]** to freeze the current screen.
 - “**HOLD**” appears while the function is in use.
 - Push **[F-2•HOLD/CLR]** again to release the function.
- ⑤ Push and hold **[F-2•HOLD/CLR]** for 1 sec. to clear the displayed characters.
 - “**HOLD**” indicator disappears at the same time when the hold function is in use.
- ⑥ Push **[F-3•AFC/NET]** to turn the AFC function ON.
 - “**AFC**” appears.
 - If a PSK signal is received within the AFC tuning range, the decoder automatically tunes into the signal and the offset frequency is displayed.
 - The AFC tuning range is set to ± 15 Hz as the default. Optional ± 8 Hz setting is available in PSK decode set mode. (p. 4-26)

NOTE: The AFC function may not tune the signal properly when a weak PSK signal is received.

- ⑦ Push **[F-3•AFC/NET]** again to turn the NET function ON.
 - “**NET**” appears additionally.
- ⑧ Push and hold **[F-3•AFC/NET]** for 1 sec. to add the offset frequency to the displayed frequency.
- ⑨ Push **[F-7•WIDE]** to toggle the PSK decode screen size from normal and wide.
 - S/R/F meter type during wide screen indication can be selected in display set mode. (pgs. 3-11, 12-10)
- ⑩ Push **[EXIT/SET]** to close the PSK decode screen.

◆ Setting the decoder threshold level



Adjust the PSK decoder threshold level if some characters are displayed when no signal is received.

- ① Call up the PSK decode screen as described above.
- ② Push **[F-5•ADJ]** to select the threshold level setting condition.
- ③ Rotate the main dial to adjust the PSK decoder threshold level.
 - Push and hold **[F-6•DEF]** for 1 sec. to select the default setting.
- ④ Push **[F-5•ADJ]** to exit from the threshold level setting condition.

◇ PSK memory transmission

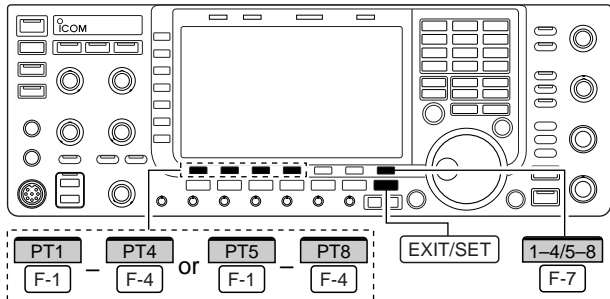

	PT1	PT2	PT3	PT4		
AGC MID	MYCALLx2			„DE Icom Icom K,“	AUTO TX/RX	
1/4 OFF	MYCALLx3			„DE Icom Icom Icom K,“	AUTO TX/RX	
VSC OFF	QSLUR599			„QSL UR 599 599 BK,“	AUTO TX/RX	
	DE+UR599			„QSL DE Icom Icom UR 599 599 BK,“	AUTO TX/RX	
	PT1	PT2	PT3	PT4	EDIT	1-4/5-8

Pre-set characters can be sent using the PSK memory. Contents of the memory are set using the edit menu.

- ① During PSK mode operation, push [F-3•DECODE] to select PSK decode screen.
- ② Push [F-4•TX MEM] to select PSK memory screen.
- ③ Push [F-7•1-4/5-8] to select memory bank then push one of the function keys ([F-1•PT1] to [F-4•PT4] or [F-1•PT5] to [F-4•PT8]).
 - When no keyboard is connected, the selected memory contents will be transmitted immediately.
 - When a keyboard is connected, the memory contents will be transmitted immediately when function key is pushed, or transmitted after [F12] on the connected keyboard is pressed, depending on auto transmission/reception setting (see below).
 - The transmission date, time, reception date and/or time may be displayed in RX contents screen, depending on setting.

◇ Automatic transmission/reception setting

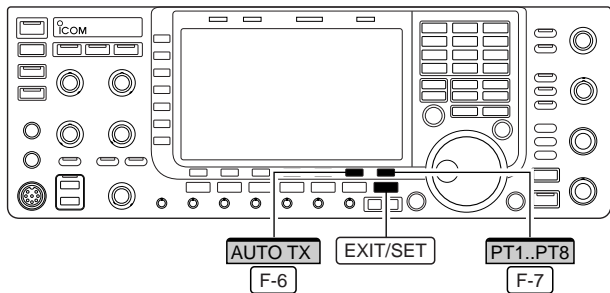

	PT1	PT2	PT3	PT4		
ABC	MYCALLx2			„DE Icom Icom K,“	AUTO TX/RX	
ABC	MYCALLx3			„DE Icom Icom Icom K,“	AUTO TX/RX	
	QSLUR599			„QSL UR 599 599 BK,“	AUTO TX/RX	
123	DE+UR599			„QSL DE Icom Icom UR 599 599 BK,“	AUTO TX/RX	
					AUTO TX	PT1..PT8

- ① During PSK mode operation, push [F-3•DECODE] to select PSK decode screen.
- ② Push [F-4•TX MEM] to select PSK memory screen, then push [F-6•EDIT] to select PSK memory edit screen.
 - PSK memory contents of Channel 1 (PT1) is selected.
- ③ Push [F-7•PT1..PT8] several times to select the desired RTTY memory.
- ④ Push [F-6•AUTO TX] several times to select the desired condition, as follows.
 - AUTO TX/RX : Automatically transmits the selected memory and returns to receive after the transmission.
 - AUTO TX : Automatically transmits the selected memory. To return to receive, press [F12] on the keyboard.
 - AUTO RX : Press [F12] on the keyboard to transmit the selected memory. Automatically returns to receive after the transmission.
 - No indication : Press [F12] on the keyboard to transmit the selected memory and press [F12] again to return to receive.
- ⑤ Push [EXIT/SET] to return to exit from PSK memory edit condition.

NOTE: The transceiver always functions in the “AUTO TX/RX” setting when no keyboard is connected.

◇ Editing PSK memory

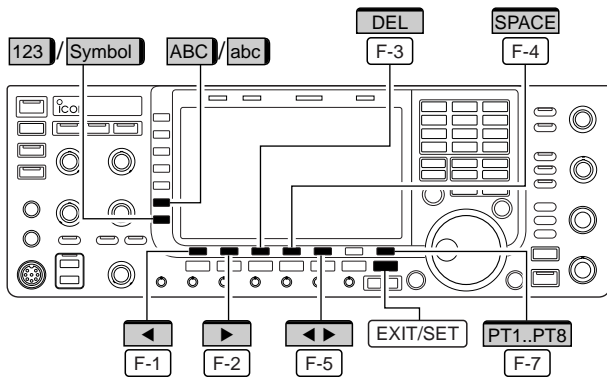

• PSK memory edit screen



• Pre-programmed contents

CH	Name	Contents
PT1	MYCALLx2	↓DE Icom Icom K↓
PT2	MYCALLx3	↓DE Icom Icom Icom K↓
PT3	QSLUR599	↓QSL UR 599 599 BK↓
PT4	DE+UR599	↓QSL DE Icom Icom UR 599 599 BK↓
PT5	73 GL SK	↓73 GL SK↓
PT6	CQ CQ CQ	↓CQ CQ CQ DE Icom Icom Icom K↓
PT7	RIG&ANT	↓My transceiver is IC-7700 & Antenna is a 3-element triband yagi.↓
PT8	EQUIP.	↓My PSK equipment is internal modulator & demodulator of the IC-7700.↓

The contents of the PSK memories can be set using the memory edit menu. The memory can store 8 PSK messages for often-used PSK information. Total capacity of the memory is 70 characters per memory channel.

• Programming contents

- ① During PSK mode operation, push [F-3•DECODE] to select PSK decode screen.
- ② Push [F-4•TX MEM] to select PSK memory screen, then push [F-6•EDIT] to select PSK memory edit screen.
 - PSK memory contents of the Channel 1 (PT1) is selected.
- ③ Push [F-7•PT1..PT8] several times to select the desired PSK memory channel to be edited.
- ④ Push [F-5•◀ ▶] to select the edit item between memory contents and memory name.
- ⑤ Push [ABC] (MF6), [abc] (MF6), [123] (MF7) or [Symbol] (MF7) to select the character group, then rotate the main dial to select the character, or push the keypad for number input.

- [abc] (MF6) appears when [ABC] (MF6) is pushed when "ABC" character group is selected, and [Symbol] (MF7) appears when [123] (MF7) is pushed when "123" character group is selected.

- Selectable characters (with the main dial);

Key selection	Editable characters
ABC	A to Z (capital letters)
abc	a to z (small letters)
123	0 to 9 (numbers)
Symbol	! # \$ % & ¥ ? " ' ` ^ + - * / . , : ; = < > () [] { } _ ~ @ ↓ ("↓" is for the memory contents setting only.)

✓ For your convenience

When a PC keyboard is connected to [USB] connector on the front panel, the PSK memory contents can also be edited from the keyboard.

- ⑥ Push [F-1•◀] or [F-2•▶] to move the cursor backwards or forwards, respectively.
 - Pushing [F-3•DEL] deletes a character and [F-4•SPACE] inserts a space.
- ⑦ Repeat steps ⑤ and ⑥ to input the desired characters.
- ⑧ Push [EXIT/SET] to set the contents and exit PSK memory edit screen.

◇ PSK decode set mode

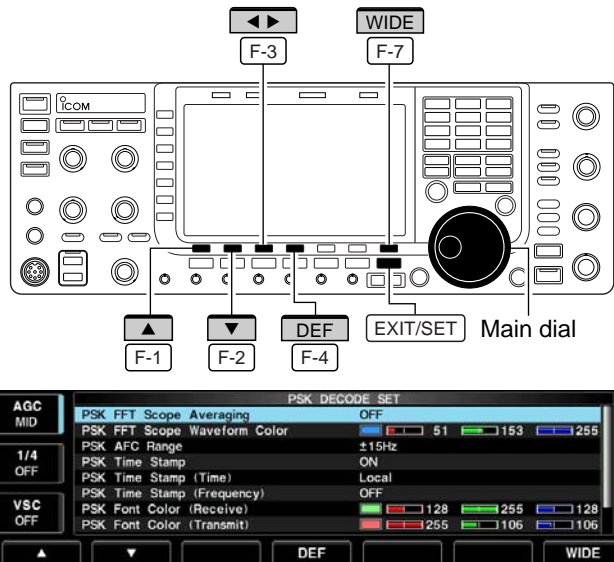

This set mode is used to set the decode USOS function, time stamp setting, etc.

• Setting contents

- ① During PSK mode operation, push [F-3•DECODE] to select PSK decode screen.
- ② Push [F-1•<MENU1>] to select PSK decode second menu, then push [F-6•SET] to select PSK decode set mode.
 - Push [F-7•WIDE] to toggle the screen size from normal and wide.
- ③ Push [F-1•▲] or [F-2•▼] to select the desired set item.
- ④ Set the desired condition using the main dial.
 - Push and hold [F-4•DEF] for 1 sec. to select a default condition or value.
 - Push [F-3•◀ ▶] to select the set contents for some items.
- ⑤ Push [EXIT/SET] to exit from set mode.

PSK FFT Scope Averaging	OFF
Select the FFT scope waveform averaging function from 2 to 4 and OFF. (default: OFF)	Recommendation! If you use the FFT scope waveform for tuning, using the default or smaller number setting is recommended.

PSK FFT Scope Waveform Color	
Set the color for the FFT scope waveform. <ul style="list-style-type: none"> • The color is set in RGB format. • The set color is indicated in the box beside the RGB scale. 	<ul style="list-style-type: none"> • Push [F-3•◀ ▶] to select R (Red), G (Green) and B (Blue), and then rotate the main dial to set the ratio from 0 to 255.

PSK AFC Range	±15Hz
Select the AFC (Automatic Frequency Control) function operating range from ±15 Hz (default) and ±8 Hz.	NOTE: The AFC function may not tune the signal properly when a weak PSK signal is received.

PSK Time Stamp	ON
Turn the time stamp (date, transmission or reception time) display ON and OFF.	<ul style="list-style-type: none"> • ON : Displays the time stamp. • OFF : No time stamp display.

PSK Time Stamp (Time)	Local
Selects the clock display for time stamp usage. NOTE: The time won't be displayed when "OFF" is selected in "PSK Time Stamp" as above.	<ul style="list-style-type: none"> • Local : Selects the time that set in "Time (Now)." • UTC* : Selects the time that set in "CLOCK2." <p>*The name of choice may differ according to "CLOCK2 Name" setting (p. 11-2). "UTC" is the default name of CLOCK2.</p>

◇ PSK decode set mode (continued)

PSK Time Stamp (Frequency)

OFF

Selects the operating frequency display for time stamp usage.

- ON : Displays the operating frequency.
- OFF : No operating frequency display.

NOTE: The frequency won't be displayed when "OFF" is selected in "PSK Time Stamp" as below left.

PSK Font Color (Receive)

 128 255 128

Set the text color for received characters.

- The color is set in RGB format.
- The set color is indicated in the box beside the RGB scale.
- Push [F-3•◀▶] to select R (Red), G (Green) and B (Blue), and then rotate the main dial to set the ratio from 0 to 255.

PSK Font Color (Transmit)

 255 106 106

Set the text color for transmitted characters.

- The color is set in RGB format.
- The set color is indicated in the box beside the RGB scale.
- Push [F-3•◀▶] to select R (Red), G (Green) and B (Blue), and then rotate the main dial to set the ratio from 0 to 255.

PSK Font Color (Time Stamp)

 0 155 189

Set the text color for time stamp indication.

- The color is set in RGB format.
- The set color is indicated in the box beside the RGB scale.
- Push [F-3•◀▶] to select R (Red), G (Green) and B (Blue), and then rotate the main dial to set the ratio from 0 to 255.

PSK Font Color (TX Buffer)

 255 255 255

Set the text color in the TX buffer screen.

- The color is set in RGB format.
- The set color is indicated in the box beside the RGB scale.
- Push [F-3•◀▶] to select R (Red), G (Green) and B (Blue), and then rotate the main dial to set the ratio from 0 to 255.

◇ Data saving

The USB-Memory is not supplied by Icom.

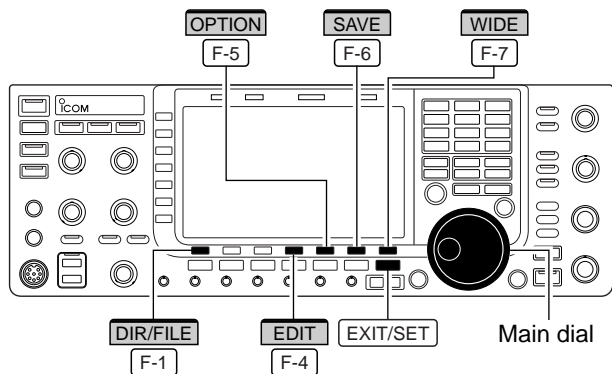

• Decode file save screen

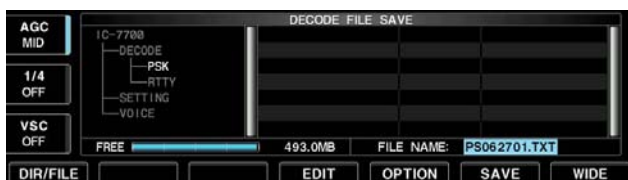

• Decode file save screen— file name edit

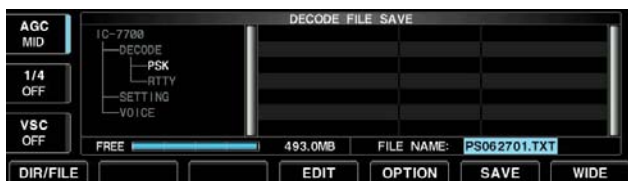

• Save option screen



The contents of the PSK memory and received signal can be saved into the USB-Memory.

- ① During PSK decode screen indication, push [F-1<MENU1>] to select PSK decode second menu.
- ② Push [F-5•SAVE] to select decode file save screen.
- ③ Change the following conditions if desired.

• File name:

- ① Push [F-4•EDIT] to select file name edit condition.
 - Push [F-1•DIR/FILE] several times to select the file name, if necessary.
- ② Push [ABC] (MF6), [123] (MF7) or [Symbol] (MF7) to select the character group, then rotate the main dial to select the character.
 - [ABC] (MF6) : A to Z (capital letters); [123] (MF7): 0 to 9 (numerals); [Symbol] (MF7): ! # \$ % & ' ` ^ + - = () [] { } _ ~ @ can be selected.
 - Push [F-1•◀] to move the cursor left, push [F-2•▶] to move the cursor right, [F-3•DEL] delete a character and push [F-4•SPACE] to insert a space.
- ③ Push [EXIT/SET] to set the file name.

• File format

- ① Push [F-5•OPTION] to enter save option screen.
- ② Rotate the main dial to select the saving format from Text and HTML.
 - “Text” is the default setting.
 - Push and hold [F-4•DEF] for 1 sec. to select the default setting.
- ③ Push [EXIT/SET] to return to the previous indication.

• Saving location

- ① Push [F-1•DIR/FILE] to select tree view screen.
- ② Select the desired directory or folder in the USB-Memory.
 - Push [F-4•◀ ▶] to select the upper directory.
 - Push [F-2•▲] or [F-3•▼] to select folder in the same directory.
 - Push and hold [F-4•◀ ▶] for 1 sec. to select a folder in the directory.
 - Push [F-5•REN/DEL] to rename the folder.
 - Push and hold [F-5•REN/DEL] for 1 sec. to delete the folder.
 - Push and hold [F-6•MAKE] for 1 sec. to make a new folder. (Edit the name with the same manner as the “• File name” above.)
- ③ Push [F-1•DIR/FILE] twice to select the file name.
- ④ Push [F-6•SAVE].
 - After saving is completed, return to PSK decode second menu automatically.

✓ For your convenience!

Two data formats, Text and HTML, are available for PC data storage.

■ Operating AM

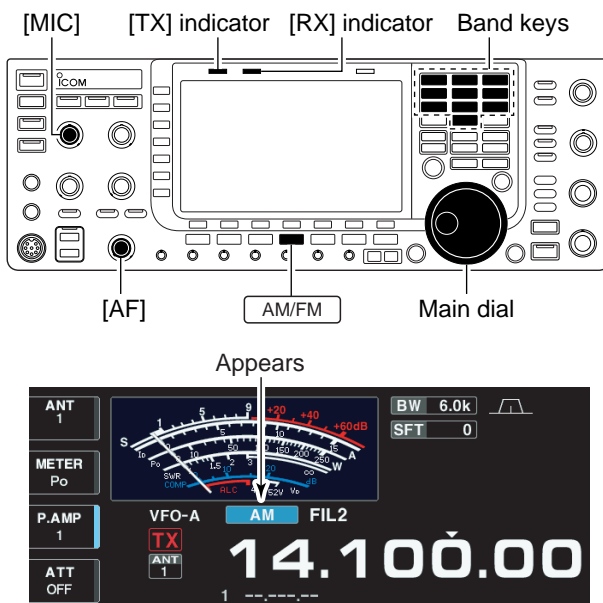

- ① Push a band key to select the desired band.
- ② Push **[AM/FM]** to select AM.
 - “AM” indicator appears.
 - After AM mode is selected, push **[AM/FM]** to toggle between AM and FM modes.
- ③ Rotate the main dial to tune to the desired frequency.
 - The S-meter indicates received signal strength when signal is received.
- ④ Rotate **[AF]** to set audio to a comfortable listening level.
- ⑤ Push **[TRANSMIT]** or **[PTT]** (microphone) to transmit.
 - The TX indicator lights red.
- ⑥ Speak into the microphone at your normal voice level.
 - Adjust the microphone gain with **[MIC]** at this step, if necessary.
- ⑦ Push **[TRANSMIT]** or release **[PTT]** (microphone) to return to receive.

◇ Convenient functions for receive

- **Preamp** (p. 5-9)
 - ➔ Push **[P.AMP]** (MF3) several times to set the preamp OFF, preamp 1 ON or preamp 2 ON.
 - “P.AMP1” or “P.AMP2” appears when the preamp 1 or preamp 2 is ON.
- **Attenuator** (p. 5-9)
 - ➔ Push **[ATT]** (MF4) several times to set the attenuator in 6 dB steps.
 - Push and hold **[ATT]** (MF3) for 1 sec. to turn the attenuator function OFF.
 - “ATT” and attenuation level appear when the attenuator is ON.
- **Noise blanker** (p. 5-16)
 - ➔ Push **[NB]** to turn the noise blanker ON and OFF, and then rotate **[NB]** control to adjust the threshold level.
 - Noise blanker indicator (above **[NB]** switch) lights when the noise blanker is ON.
 - Push and hold **[NB]** for 1 sec. to enter noise blanker set mode.
- **Noise reduction** (p. 5-17)
 - ➔ Push **[NR]** to turn the noise reduction ON and OFF.
 - Rotate **[NR]** control to adjust the noise reduction level.
 - Noise reduction indicator (above **[NR]** switch) lights when the noise reduction is ON.
- **Audio tone control** (p. 12-4)
 - ➔ Push **[F-7•SET]** then **[F-1•LEVEL]** to enter level set mode. Select an item with **[F-1•▲]/[F-2•▼]** then rotate the main dial to adjust the audio tone.
- **Twin PBT (passband tuning)** (p. 5-12)
 - ➔ Rotate **[TWIN PBT]** controls (inner/outer).
 - PBT indicator (above **[PBT-CLR]** switch) lights when PBT is in use.
 - Push and hold **[PBT-CLR]** for 1 sec. to clear the settings.
- **Notch filter** (p. 5-18)
 - ➔ Push **[NOTCH]** to turn the manual notch function ON and OFF.
 - Rotate **[NOTCH]** control to set the attenuating frequency.
 - Notch indicator (above **[NOTCH]** switch) lights when either the auto or manual notch is ON.
- **AGC (auto gain control)** (p. 5-11)
 - ➔ Push **[AGC]** switch several times to select AGC FAST, AGC MID or AGC SLOW.
 - ➔ Push **[AGC VR]** to turn the AGC time constant manual setting ON and OFF.
 - Rotate **[AGC]** control to adjust the time constant.
- **Auto tuning function** (p. 5-19)
 - ➔ Push **[AUTOTUNE]** to turn the auto tuning function ON and OFF.
 - The transceiver automatically tunes the desired signal within ± 5 kHz range.

IMPORTANT!

When receiving a weak signal, or receiving a signal with interference, the automatic tuning function may not tune, or may tune to an undesired signal.

◇ Convenient functions for transmit

- **VOX (voice operated transmit)** (p. 6-2)
 - ➔ Push **VOX** to turn the VOX function ON and OFF.
 - “**VOX**” appears when the VOX function is ON.
- **Transmit quality monitor** (p. 6-4)
 - ➔ Push **MONITOR** to turn the monitor function ON and OFF.
 - Rotate [MONI GAIN] to adjust the monitor gain.
 - Monitor indicator (above **MONITOR** switch) lights when the monitor function is ON.
- **Audio tone control** (p. 12-5)
 - ➔ Push [F-7•SET] then [F-1•LEVEL] to enter level set mode. Select an item with [F-1•▲]/[F-2•▼] then rotate the main dial to adjust the audio tone.

■ Operating FM

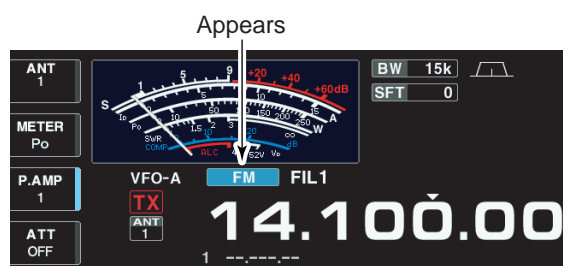
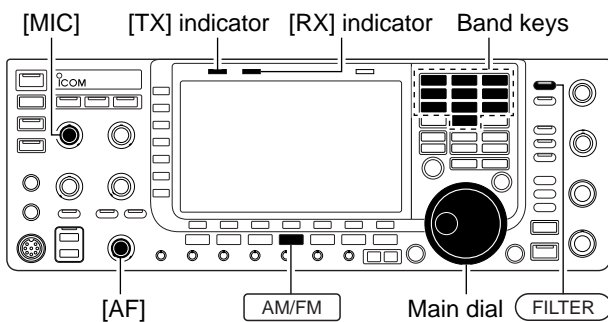

- ① Push a band key to select the desired band.
- ② Push **[AM/FM]** to select FM.
 - “FM” indicator appears.
 - After FM mode is selected, push **[AM/FM]** to toggle between FM and AM modes.
- ③ Rotate the main dial to tune to the desired frequency.
 - The S-meter indicates received signal strength when signal is received.
 - 10 kHz tuning step is preset for the FM mode.
 - Push **[FILTER]** several times to select the desired filter width.
- ④ Rotate **[AF]** to set audio to a comfortable listening level.
- ⑤ Push **[TRANSMIT]** or **[PTT]** (microphone) to transmit.
 - The TX indicator lights red.
- ⑥ Speak into the microphone at your normal voice level.
 - Adjust the microphone gain with **[MIC]** at this step, if necessary.
 - FM narrow transmission is available when “FIL2” or “FIL3” is selected.
- ⑦ Push **[TRANSMIT]** or release **[PTT]** (microphone) to return to receive.

◇ Convenient functions for receive

- **Preamp** (p. 5-9)
 - ➔ Push **[P.AMP]** (MF3) several times to set the preamp OFF, preamp 1 ON or preamp 2 ON.
 - “P.AMP1” or “P.AMP2” appears when the preamp 1 or preamp 2 is ON.
- **Auto notch filter** (p. 5-18)
 - ➔ Push **[NOTCH]** to turn the auto notch function ON and OFF.
 - Notch indicator (above **[NOTCH]** switch) lights when the auto notch is ON.
- **Attenuator** (p. 5-9)
 - ➔ Push **[ATT]** (MF4) several times to set the attenuator in 6 dB steps.
 - Push and hold **[ATT]** (MF4) for 1 sec. to turn the attenuator function OFF.
 - “ATT” and attenuation level appear when the attenuator is ON.
- **Audio tone control** (p. 12-4)
 - ➔ Push **[F-7•SET]** then **[F-1•LEVEL]** to enter level set mode. Select an item with **[F-1•▲]/[F-2•▼]** then rotate the main dial to adjust the audio tone.

◇ Convenient functions for transmit

- **VOX (voice operated transmit)** (p. 6-2)
 - ➔ Push **[VOX]** to turn the VOX function ON and OFF.
 - “**VOX**” appears when the VOX function is ON.
- **Transmit quality monitor** (p. 6-4)
 - ➔ Push **[MONITOR]** to turn the monitor function ON and OFF.
 - Rotate **[MONI GAIN]** to adjust the monitor gain.
 - Monitor indicator (above **[MONITOR]** switch) lights when the monitor function is ON.
- **Audio tone control** (p. 12-5)
 - ➔ Push **[F-7•SET]** then **[F-1•LEVEL]** to enter level set mode. Select an item with **[F-1•▲]/[F-2•▼]** then rotate the main dial to adjust the audio tone.

■ Repeater operation

A repeater amplifies received signals and retransmits them at a different frequency. When using a repeater, the transmit frequency is shifted from the receive frequency by an offset frequency. A repeater can be accessed using split frequency operation with the shift frequency set to the repeater's receive frequency.

▨ For accessing a repeater which requires a repeater tone, set the repeater tone frequency in tone frequency set mode as described below.

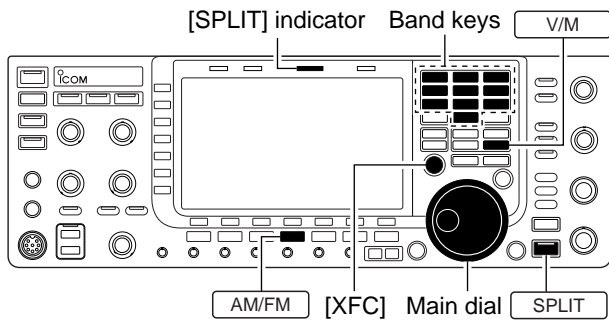

- ① Set the offset frequencies (HF, 50 MHz) and turn ON the quick split function in Others set mode in advance. (pgs. 12-12, 12-13)
- ② Push **V/M** to select VFO mode.
- ③ Push the desired band key.
- ④ Push **AM/FM** several times to select FM mode.
- ⑤ Set the receive frequency (repeater output frequency).
- ⑥ Push and hold **SPLIT** for 1 sec. to start repeater operation.
 - Repeater tone is turned ON automatically.
 - [SPLIT] indicator lights and "**SPLIT**" appears on the LCD.
 - Shifted transmit frequency and "TX" appear in the sub band.
 - The transmit frequency can be monitored while pushing [XFC].
- ⑦ Push and hold [PTT] to transmit; release [PTT] to receive.
- ⑧ To return to simplex, push **SPLIT** momentarily.

◇ Repeater tone frequency setting

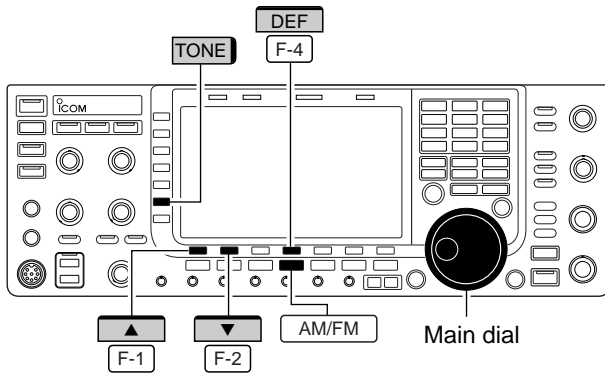

Some repeaters require subaudible tones to be accessed. Subaudible tones are superimposed on your normal signal and must be set in advance. The transceiver has 50 tones from 67.0 Hz to 254.1 Hz.

- ① Select FM mode.
- ② Push and hold [TONE] for 1 sec. to tone frequency set mode.
- ③ Push [F-1•▲] or [F-2•▼] to select REPEATER TONE item.
- ④ Rotate the main dial to select the desired repeater tone frequency.
 - Push and hold [F-4•DEF] for 1 sec. to select the default setting.
- ⑤ Push [EXIT/SET] to return to the previous indication.

• Available tone frequencies (unit: Hz)

67.0	85.4	107.2	136.5	165.5	186.2	210.7	254.1
69.3	88.5	110.9	141.3	167.9	189.9	218.1	
71.9	91.5	114.8	146.2	171.3	192.8	225.7	
74.4	94.8	118.8	151.4	173.8	196.6	229.1	
77.0	97.4	123.0	156.7	177.3	199.5	233.6	
79.7	100.0	127.3	159.8	179.9	203.5	241.8	
82.5	103.5	131.8	162.2	183.5	206.5	250.3	

■ Tone squelch operation

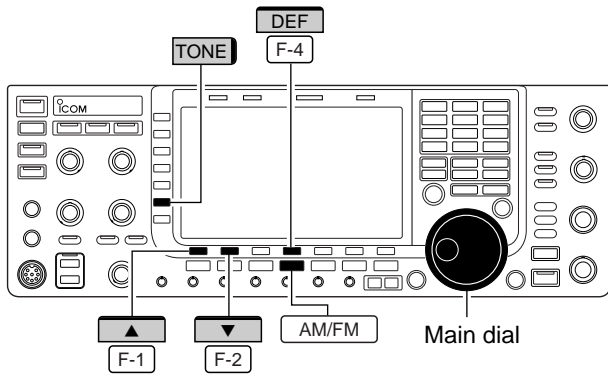

The tone squelch opens only when receiving a signal containing a matching subaudible tone. You can silently wait for calls from group members using the same tone.

- ① Set the desired frequency band and select FM mode.
- ② Push [TONE] to turn the tone squelch function ON.
 - “**TSQL**” appears
- ③ Push and hold [TONE] for 1 sec. to tone frequency set mode.
- ④ Push [F-1•▲] or [F-2•▼] to select T-SQL TONE item.
- ⑤ Rotate the main dial to select the desired tone squelch frequency.
 - Push and hold [F-4•DEF] for 1 sec. to select the default setting.
- ⑥ Push [EXIT/SET] to return to the previous indication.
- ⑦ When the received signal includes a matching tone, squelch opens and the signal can be heard.
 - When the received signal's tone does not match, tone squelch does not open. However, the S-indicator shows signal strength.
 - To open the squelch manually, push [XFC].
- ⑧ Operate the transceiver in the normal way.
- ⑨ To cancel the tone squelch, push [TONE] to clear “TSQL.”

• Available tone frequencies (unit: Hz)

67.0	85.4	107.2	136.5	165.5	186.2	210.7	254.1
69.3	88.5	110.9	141.3	167.9	189.9	218.1	
71.9	91.5	114.8	146.2	171.3	192.8	225.7	
74.4	94.8	118.8	151.4	173.8	196.6	229.1	
77.0	97.4	123.0	156.7	177.3	199.5	233.6	
79.7	100.0	127.3	159.8	179.9	203.5	241.8	
82.5	103.5	131.8	162.2	183.5	206.5	250.3	

■ Data mode (AFSK) operation

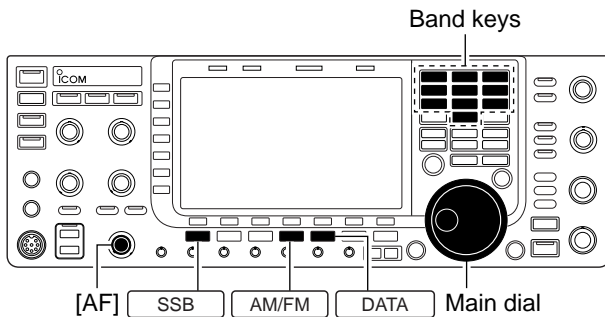

• Tone-pair example

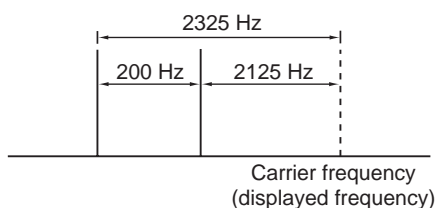

When operating AMTOR or PACKET with your TNC and/or PC software, consult the manual that comes with the TNC and/or the software.

- ① Connect a PC and TNC to the transceiver. (p. 2-9)
- ② Push a band key to select the desired band.
- ③ Push **[SSB]** or **[AM/FM]** to select the desired operating mode.
- ④ Push **[DATA]** to turn data mode ON.
 - One of "-D1," "-D2" or "-D3" is additionally appears.
 - During data mode selection, push and hold **[DATA]** for 1 sec. to select data mode 1 (D1), 2 (D2) and 3 (D3) in sequence.
- ⑤ Rotate the main dial to tune to the desired signal and decode it correctly.
 - Also use the tuning indicator of the TNC or software.
 - During SSB data mode, 1/4 tuning function can be used for critical tuning.
- ⑥ Operate the PC (software) or TNC to transmit.
 - When operating in SSB data mode, adjust the TNC output level so that the ALC meter reading doesn't go outside the ALC zone.

NOTE: When SSB data mode is selected, the audio input from the [ACC1] (pin 6) is used for transmission instead of [MIC]'s.

The fixed condition is used for SSB data transmission as follows:

- [COMP] : OFF
- Tx bandwidth : MID
- Tx Tone (Bass) : 0
- Tx Tone (Trebles) : 0

✓ For your information

Carrier frequency is displayed when SSB data mode is selected.

See the diagram left for the tone-pair example.

■ Spectrum scope screen	5-2
◇ Center mode	5-2
◇ Fixed mode	5-3
◇ Mini scope screen indication	5-4
◇ Scope set mode	5-4
■ Preamplifier	5-9
■ Attenuator	5-9
■ RIT function	5-10
◇ RIT monitor function	5-10
■ AGC function	5-11
◇ Selecting the preset value	5-11
◇ Adjusting the AGC time constant	5-11
◇ Setting the AGC time constant preset value	5-11
■ Twin PBT operation	5-12
■ IF filter selection	5-13
◇ IF filter selection	5-13
◇ Filter passband width setting (except FM mode)	5-13
◇ Roofing filter selection	5-14
◇ DSP filter shape	5-14
◇ Filter shape set mode	5-14
■ Noise blanker	5-16
◇ NB set mode	5-16
■ Noise reduction	5-17
■ Dial lock function	5-17
■ Notch function	5-18
■ Digital selector	5-18
■ Autotune function	5-19

■ Spectrum scope screen

◇ Center mode

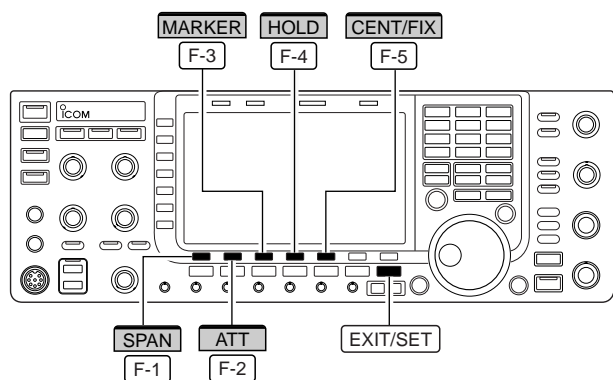

• Observed indication example

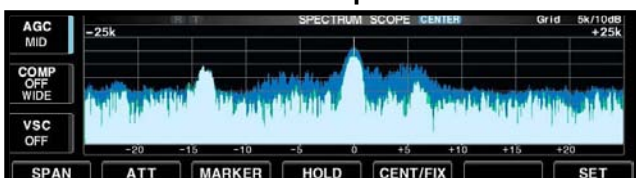

This DSP-based spectrum scope allows you to display the conditions on the selected band, as well as relative strengths of signals. The IC-7700 has two modes for the spectrum indication— one is center mode, and another one is fixed mode.

In addition, the IC-7700 has a mini scope screen to save screen space.

Displays signals around the set frequency within the selected span. The set frequency is always displayed at the center of the screen.

- ① Push [EXIT/SET] several times to close a multi-function screen, if necessary.
- ② Push [F-1•SCOPE] to select the scope screen.
- ③ Push [F-5•CENT/FIX] to select the center mode.
 - “CENTER” is displayed when center mode is selected.
- ④ Push [F-1•SPAN] several times to select the scope span.
 - ± 2.5 , ± 5.0 , ± 10 , ± 25 , ± 50 , ± 100 and ± 250 kHz are available.
 - Push and hold [F-1•SPAN] for 1 sec. to return to ± 2.5 kHz span.
 - Sweeping speed is selectable for each span independently in scope set mode. (pgs. 5-5, 5-6)
- ⑤ Push [F-2•ATT] several times to activate an attenuator or turn the attenuator OFF.
 - 10, 20 and 30 dB attenuators are available.
 - Push and hold [F-2•ATT] for 1 sec. to turn OFF the attenuator.
- ⑥ Push [F-3•MARKER] to turn the marker for transmit frequency ON or OFF.
 - “T” displays the marker at the transmit frequency.
 - “<<” or “>>” appears when the marker is out of range.
 - The spectrum scope shows the transmit signal waveform while transmitting. This can be deactivated in scope set mode. (p. 5-5)
 - The spectrum scope shows the peak level holding function. Peak levels are displayed in the background of the current spectrum in a different color until the receive frequency changes. This can be deactivated and the waveform color can be set in scope set mode. (p. 5-5)
- ⑦ Push [F-4•HOLD] to freeze the current spectrum waveform.
 - “HOLD” appears while the function is in use.
 - The peak hold function can be deactivated in scope set mode.
- ⑧ Push [EXIT/SET] to exit the scope screen.

NOTE: If a strong signal is received, a ghost waveform may appear. Push [F-2•ATT] several times to activate the spectrum scope attenuator in this case. Spurious signal waveforms may be displayed. They are generated in the internal scope circuit and do not indicate a transceiver malfunction.

◆ Fixed mode

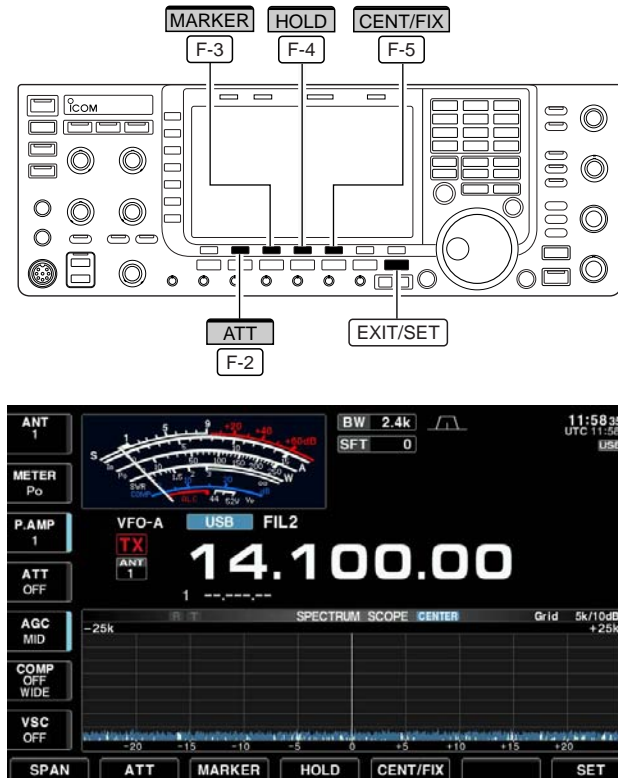

Displays signals within the specified frequency range. The selected frequency band conditions can be observed at a glance when using this mode.

- ① Push [EXIT/SET] several times to close a multi-function screen, if necessary.
- ② Push [F-1•SCOPE] to select the scope screen.
- ③ Push [F-5•CENT/FIX] to select the fixed mode.
 - “**FIX**” is displayed when fixed mode is selected.
- ④ Push [F-2•ATT] several times to activate an attenuator or turn the attenuator OFF.
 - 10, 20 and 30 dB attenuators are available.
 - Push and hold [F-2•ATT] for 1 sec. to turn OFF the attenuator.
- ⑤ Push [F-3•MARKER] several times to select the marker for transmit frequency or turn the marker OFF.
 - “**R**” displays the marker at the receive frequency. (always displayed)
 - “**T**” displays the marker at the transmit frequency.
 - “<<” or “>>” appears when the marker is out of range.
 - The spectrum scope shows the transmit signal waveform while transmitting. This can be deactivated in scope set mode. (p. 5-5)
 - The spectrum scope shows the peak level holding function. Peak levels are displayed in the background of the current spectrum in a different color until the receive frequency changes. This can be deactivated and the waveform color can be set in scope set mode. (p. 5-5)
- ⑥ Push [F-4•HOLD] to freeze the current spectrum waveform.
 - “**HOLD**” appears while the function is in use.
 - The peak hold function can be deactivated in scope set mode.
- ⑦ Push [EXIT/SET] to exit the scope screen.

/// **NOTE:** If a strong signal is received, a ghost waveform may appear. Push [F-2•ATT] several times to activate the spectrum scope attenuator in this case.

/// The scope bandwidth can be specified for each operating frequency band independently in scope set mode. (pgs. 5-6 to 5-8)

5 FUNCTIONS FOR RECEIVE

◇ Mini scope screen indication

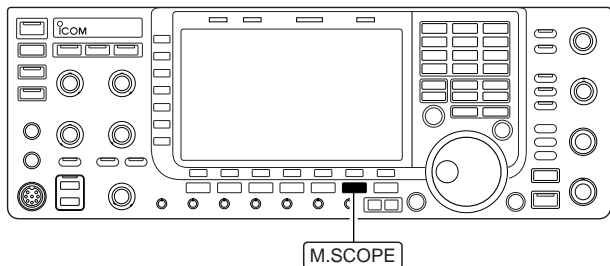

The mini scope screen can be displayed with another screen display, such as set mode menu, decode screen, memory list screen, etc. simultaneously.

- ① Set the scope mode (center or fixed), marker, attenuator, span, etc. in advance. (pgs. 5-2, 5-3)
- ② Push **M.SCOPE** to toggle the mini scope indication ON and OFF.
 - The S/R/F meter type during mini scope indication can be selected in display set mode (Meter Type (Wide Screen) item). (p. 12-10)



◇ Scope set mode

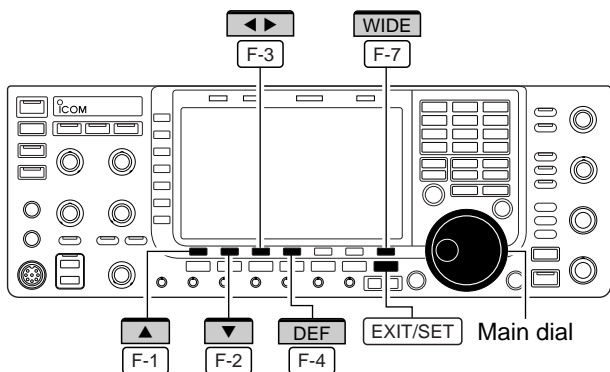

This set mode is used to set the waveform color, sweeping speed, scope range for fixed mode, etc.

- ① During spectrum scope display ON, push **[F-7•SET]** to select scope set mode screen.
 - Push **[F-7•WIDE]** to toggle the screen size between normal and wide.
- ② Push **[F-1•▲]** or **[F-2•▼]** to select the desired set item.
- ③ Set the desired condition using the main dial.
 - Push and hold **[F-4•DEF]** for 1 sec. to select the default condition or value.
 - Push **[F-3•◀ ▶]** to select the set contents for some items.
- ④ Push **EXIT/SET** to exit from set mode.



◇ Scope set mode (continued)

Scope during Tx (CENTER Type)

ON

Turn the transmitting signal waveform indication ON and OFF.

/// **NOTE:** The transmitting signal waveform indication is available for the center mode only.

Max Hold

ON

Turn the peak level holding function ON and OFF.

CENTER Type Display

Select the center frequency of the spectrum scope indication (center mode only).

Filter Center

- Filter center : Shows the selected filter's center frequency at the center.
- Carrier Point Center : Shows the selected operating mode carrier point frequency at the center.
- Carrier Point Center (Abs. Freq.) : In addition to the carrier point center setting above, the actual frequency is displayed for the bottom of the scope.

Waveform Color (Current)



Set the waveform color for the currently received signals.

- The color is set in RGB format.
- Push [F-3•◀▶] to select R (Red), G (Green) and B (Blue), and rotate the ratio from 0 to 255 range.
- The set color is indicated in the box beside the RGB scale.

Waveform Color (Max Hold)



Set the waveform color for the receiving signals maximum level.

- The color is set in RGB format.
- Push [F-3•◀▶] to select R (Red), G (Green) and B (Blue), and rotate the ratio from 0 to 255 range.
- The set color is indicated in the box beside the RGB scale.

Sweep Speed (± 2.5k)

MID

Select the sweep speed for the ±2.5 kHz span selection from SLOW, MID and FAST.

/// **NOTE:** The waveform may be displayed incorrectly with "FAST" setting.

(± 5k)

MID

Select the sweep speed for the ±5 kHz span selection from SLOW, MID and FAST.

/// **NOTE:** The waveform may be displayed incorrectly with "FAST" setting.

(± 10k)

FAST

Select the sweep speed for the ±10 kHz span selection from SLOW, MID and FAST.

◇ Scope set mode (continued)

(± 25k)	FAST
Select the sweep speed for the ±25 kHz span selection from SLOW, MID and FAST.	

(± 50k)	FAST
Select the sweep speed for the ±50 kHz span selection from SLOW, MID and FAST.	

(± 100k)	FAST
Select the sweep speed for the ±100 kHz span selection from SLOW, MID and FAST.	

(± 250k)	FAST
Select the sweep speed for the ±250 kHz span selection from SLOW, MID and FAST.	

Fixed Edges (0.03 – 1.60)	0.750 – 1.250 MHz
Set the scope edge frequencies for fixed mode for bands below 1.6 MHz.	<ul style="list-style-type: none"> • Set the frequencies within 0.030 to 1.600 MHz range in 1 kHz steps. ▨ Up to 500 kHz band width can be specified, so either edge frequency will be set to the difference between higher and lower frequencies from 5 to 500 kHz automatically while setting another edge frequency.

(1.60 – 2.00)	1.800 – 2.000 MHz
Set the scope edge frequencies for fixed mode scope when the 1.6 to 2 MHz band is selected.	<ul style="list-style-type: none"> • Set the frequencies within 1.600 to 2.000 MHz range in 1 kHz steps.

(2.00 – 6.00)	3.500 – 4.000 MHz
Set the scope edge frequencies for fixed mode scope when the 2 to 6 MHz band is selected.	<ul style="list-style-type: none"> • Set the frequencies within 2.000 to 6.000 MHz range in 1 kHz steps. ▨ Up to 500 kHz band width can be specified, so either edge frequency will be set to the difference between higher and lower frequencies from 5 to 500 kHz automatically while setting another edge frequency.

(6.00 – 8.00)	7.000 – 7.300 MHz
Set the scope edge frequencies for fixed mode scope when the 6 to 8 MHz band is selected.	<ul style="list-style-type: none"> • Set the frequencies within 6.000 to 8.000 MHz range in 1 kHz steps. ▨ Up to 500 kHz band width can be specified, so either edge frequency will be set to the difference between higher and lower frequencies from 5 to 500 kHz automatically while setting another edge frequency.

◇ Scope set mode (continued)

(8.00 – 11.00)

10.100 – 10.150 MHz

Set the scope edge frequencies for fixed mode scope when the 8 to 11 MHz band is selected.

- Set the frequencies within 8.000 to 11.000 MHz range in 1 kHz steps.
 - ▨ Up to 500 kHz band width can be specified, so either edge frequency will be set to the difference between higher and lower frequencies from 5 to 500 kHz automatically while setting another edge frequency.

(11.00 – 15.00)

14.000 – 14.350 MHz

Set the scope edge frequencies for fixed mode scope when the 11 to 15 MHz band is selected.

- Set the frequencies within 11.000 to 15.000 MHz range in 1 kHz steps.
 - ▨ Up to 500 kHz band width can be specified, so either edge frequency will be set to the difference between higher and lower frequencies from 5 to 500 kHz automatically while setting another edge frequency.

(15.00 – 20.00)

18.068 – 18.168 MHz

Set the scope edge frequencies for fixed mode scope when the 15 to 20 MHz band is selected.

- Set the frequencies within 15.000 to 20.000 MHz range in 1 kHz steps.
 - ▨ Up to 500 kHz band width can be specified, so either edge frequency will be set to the difference between higher and lower frequencies from 5 to 500 kHz automatically while setting another edge frequency.

(20.00 – 22.00)

21.000 – 21.450 MHz

Set the scope edge frequencies for fixed mode scope when the 20 to 22 MHz band is selected.

- Set the frequencies within 20.000 to 22.000 MHz range in 1 kHz steps.
 - ▨ Up to 500 kHz band width can be specified, so either edge frequency will be set to the difference between higher and lower frequencies become 5 to 500 kHz automatically while setting another edge frequency.

(22.00 – 26.00)

24.890 – 24.990 MHz

Set the scope edge frequencies for fixed mode scope when the 22 to 26 MHz band is selected.

- Set the frequencies within 22.000 to 26.000 MHz range in 1 kHz steps.
 - ▨ Up to 500 kHz band width can be specified, so either edge frequency will be set to the difference between higher and lower frequencies from 5 to 500 kHz automatically while setting another edge frequency.

◇ Scope set mode (continued)

(26.00 – 30.00)	28.000 – 28.500 MHz
Set the scope edge frequencies for fixed mode scope when the 26 to 30 MHz band is selected.	<ul style="list-style-type: none">• Set the frequencies within 26.000 to 30.000 MHz range in 1 kHz steps. /// Up to 500 kHz band width can be specified, so either edge frequency will be set to the difference between higher and lower frequencies from 5 to 500 kHz automatically while setting another edge frequency.
(30.00 – 45.00)	30.000 – 30.500 MHz
Set the scope edge frequencies for fixed mode scope when the 30 to 45 MHz band is selected.	<ul style="list-style-type: none">• Set the frequencies within 30.000 to 45.000 MHz range in 1 kHz steps. /// Up to 500 kHz band width can be specified, so either edge frequency will be set to the difference between higher and lower frequencies from 5 to 500 kHz automatically while setting another edge frequency.
(45.00 – 60.00)	50.000 – 50.500 MHz
Set the scope edge frequencies for fixed mode scope when the 45 to 60 MHz band is selected.	<ul style="list-style-type: none">• Set the frequencies within 45.000 to 60.000 MHz range in 1 kHz steps. /// Up to 500 kHz band width can be specified, so either edge frequency will be set to the difference between higher and lower frequencies from 5 to 500 kHz automatically while setting another edge frequency.

■ Preamplifier

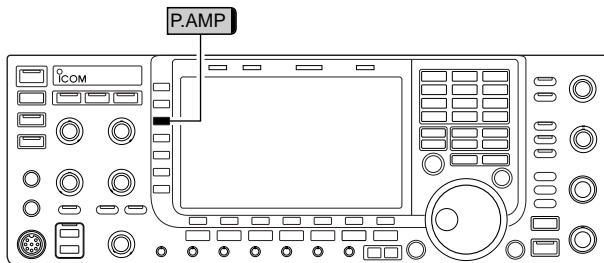

The preamp amplifies received signals in the receiver front end, to improve the S/N ratio and sensitivity. Set this to preamp 1 or preamp 2 when receiving weak signals.

➔ Push [P.AMP] (MF3) several times to set the preamp OFF, preamp 1 ON or preamp 2 ON.



For all HF bands



High-gain preamp for 24 MHz band and above

✓ About the "P.AMP2"

The "P.AMP 2" is a high gain receive amplifier. When the "P.AMP 2" is used in the presence of strong electromagnetic fields, distortion sometimes results. In such cases, use the transceiver with the "P.AMP 1" or "P.AMP OFF" setting.

The "P.AMP 2" is most effective when:

- Used on bands above 24 MHz and when signals are weak.
- Receive sensitivity is insufficient when using low-gain antennas, or while using a narrow band antenna (such as small loop, a Beverage antenna or a short Yagi antenna).

■ Attenuator

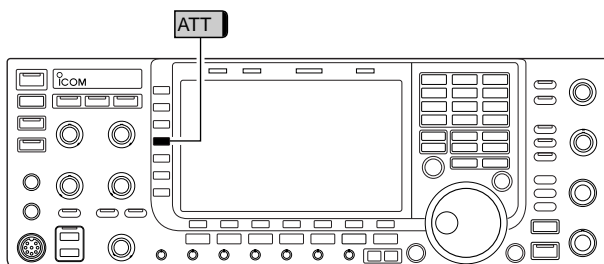

The attenuator prevents a desired signal from distortion when very strong signals are near the desired frequency or when very strong electromagnetic fields, such as from broadcasting stations near your location.

➔ Push [ATT] (MF4) several times to set the attenuator 6 dB, 12 dB, 18 dB or attenuator OFF.

➔ Push and hold [ATT] (MF4) for 1 sec. to turn the attenuator function OFF.



6 dB
attenuation



12 dB
attenuation



18 dB
attenuation

■ RIT function

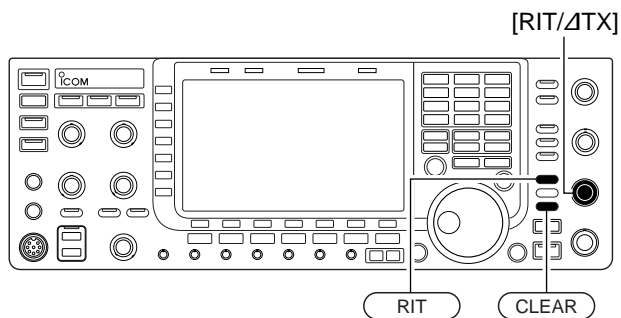

The RIT (Receive Increment Tuning) function compensates for off-frequency operation of the received station.

The function shifts the receive frequency up to ± 9.99 kHz in 10 Hz steps without moving the transmit frequency.

- ① Push **[RIT]** to turn the RIT function ON and OFF.
 - “**[RIT]**” and the shifting frequency appear when the function is ON.
- ② Rotate the **[RIT/ΔTX]** control.
 - Push and hold **[CLEAR]** for 1 sec. to reset the RIT frequency.
 - Push **[CLEAR]** momentarily to reset the RIT frequency when the quick RIT/ΔTX clear function is ON. (p. 12-15)
 - Push and hold **[RIT]** for 1 sec. to add the shift frequency to the operating frequency.

◇ RIT monitor function

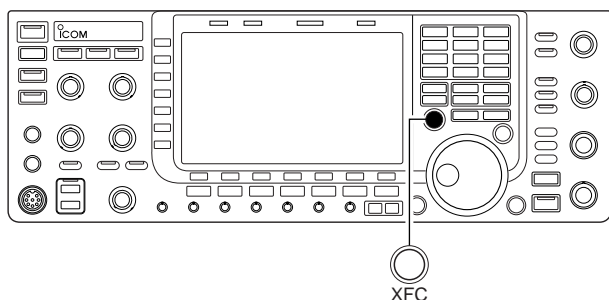

When the RIT function is ON, pushing and holding **[XFC]** allows you to monitor the operating frequency directly (RIT is temporarily cancelled).

✓ **For your convenience— Calculate function**

The shift frequency of the RIT function can be added/subtracted to the displayed frequency.

- While displaying the RIT shift frequency, push and hold **[RIT]** for 1 sec.
-

**Downloaded by
RadioAmateur.EU**

■ AGC function

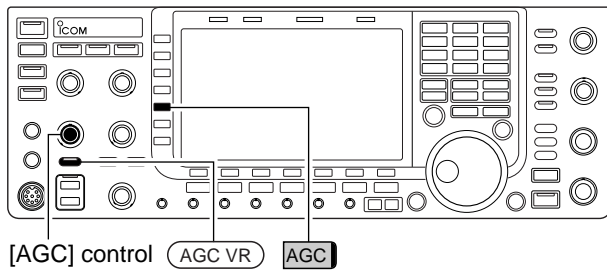

The AGC (auto gain control) controls receiver gain to produce a constant audio output level even when the received signal strength varies greatly.

The transceiver has 3 preset AGC characteristics (time constant: fast, mid, slow) for non-FM mode.

⚡ The FM mode AGC time constant is fixed as 'FAST' (0.1 sec.) and AGC time constant cannot be changed.

◇ Selecting the preset value

- ① Select any non-FM mode.
- ② Push [AGC] (MF5) several times to select AGC fast, AGC medium (MID) or AGC slow.
 - Push and hold [AGC VR] for 1 sec. to turn the AGC function OFF.

◇ Adjusting the AGC time constant

- ① Select any non-FM mode.
- ② Push [AGC VR], then rotate [AGC] control to adjust the AGC time constant.
 - [AGC VR] indicator above the switch lights green.

◇ Setting the AGC time constant preset value



- ① Select any non-FM mode.
- ② Push and hold [AGC] (MF5) for 1 sec. to enter AGC set mode.
- ③ Push [AGC] (MF5) several times to select FAST time constant.
- ④ Rotate the main dial to set the desired time constant for 'AGC FAST.'
 - AGC time constant can be set between 0.1 to 8.0 sec. (depends on mode) or turned OFF.
 - Push and hold [F-4•DEF] for 1 sec. to select a default value.
- ⑤ Push [AGC] (MF5) to select medium time constant.
- ⑥ Rotate the main dial to set the desired time constant for 'AGC MID.'
 - AGC time constant can be set between 0.1 to 8.0 sec. (depends on mode) or turned OFF.
 - Push and hold [F-4•DEF] for 1 sec. to select a default value.
- ⑦ Push [AGC] (MF5) to select slow time constant.
- ⑧ Rotate the main dial to set the desired time constant for 'AGC SLOW.'
 - AGC time constant can be set between 0.1 to 8.0 sec. (depends on mode) or turned OFF.
 - Push and hold [F-4•DEF] for 1 sec. to select a default value.
- ⑨ Select another non-FM mode. Repeat steps ③ to ⑧ if desired.
- ⑩ Push [EXIT/SET] to exit the AGC set mode screen.

• Selectable AGC time constant (unit: sec.)

Mode	Default	Selectable AGC time constant
SSB	0.3 (FAST)	0.1, 0.2, 0.3, 0.5, 0.8, 1.2, 1.6, 2.0, 2.5, 3.0, 4.0, 5.0, 6.0
	2.0 (MID)	
	6.0 (SLOW)	
CW	0.1 (FAST)	0.1, 0.2, 0.3, 0.5, 0.8, 1.2, 1.6, 2.0, 2.5, 3.0, 4.0, 5.0, 6.0
	0.5 (MID)	
	1.2 (SLOW)	
RTTY PSK	0.1 (FAST)	0.1, 0.2, 0.3, 0.5, 0.8, 1.2, 1.6, 2.0, 2.5, 3.0, 4.0, 5.0, 6.0
	0.5 (MID)	
	1.2 (SLOW)	
AM	3.0 (FAST)	0.3, 0.5, 0.8, 1.2, 1.6, 2.0, 2.5, 3.0, 4.0, 5.0, 6.0, 7.0, 8.0
	5.0 (MID)	
	7.0 (SLOW)	
FM	0.1 (FAST)	Fixed

■ Twin PBT operation

PBT (Passband Tuning) electronically narrows the IF passband width by shifting the IF frequency slightly outside of the IF filter passband to reject interference. The IC-7700 uses DSP for the PBT function. Moving both [TWIN-PBT] controls to the same position shifts the IF for both high and low frequencies.

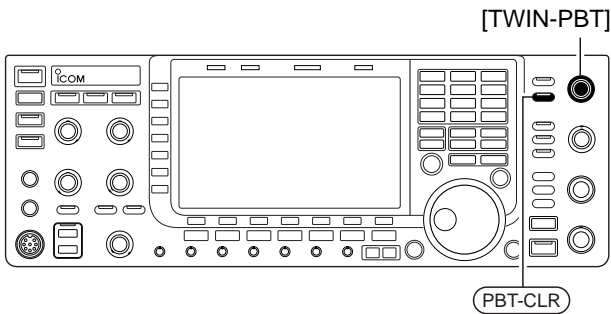

Shows filter width, shifting value and condition



- The LCD shows the passband width and shift frequency graphically.
 - PBT indicator above [PBT-CLR] switch lights when PBT is in use.
- Push and hold [FILTER] for 1 sec. to enter the filter set screen. Current passband width and shift frequency is displayed in the filter set screen.
- To set the [TWIN-PBT] controls to the center positions, push and hold [PBT-CLR] for 1 sec.

The variable range depends on the passband width and mode. The edge of the variable range is half of the passband width, and PBT is adjustable in 25 (SSB/CW/RTTY/PSK modes) or 100 Hz (AM mode) steps.

- [TWIN-PBT] should normally be set to the center positions (PBT setting is cleared) when there is no interference.
- When PBT is used, the audio tone may be changed.
- Not available for FM mode.
- While rotating [TWIN-PBT], noise may occur. This comes from the DSP unit and does not indicate an equipment malfunction.

• Filter set screen



• PBT operation example

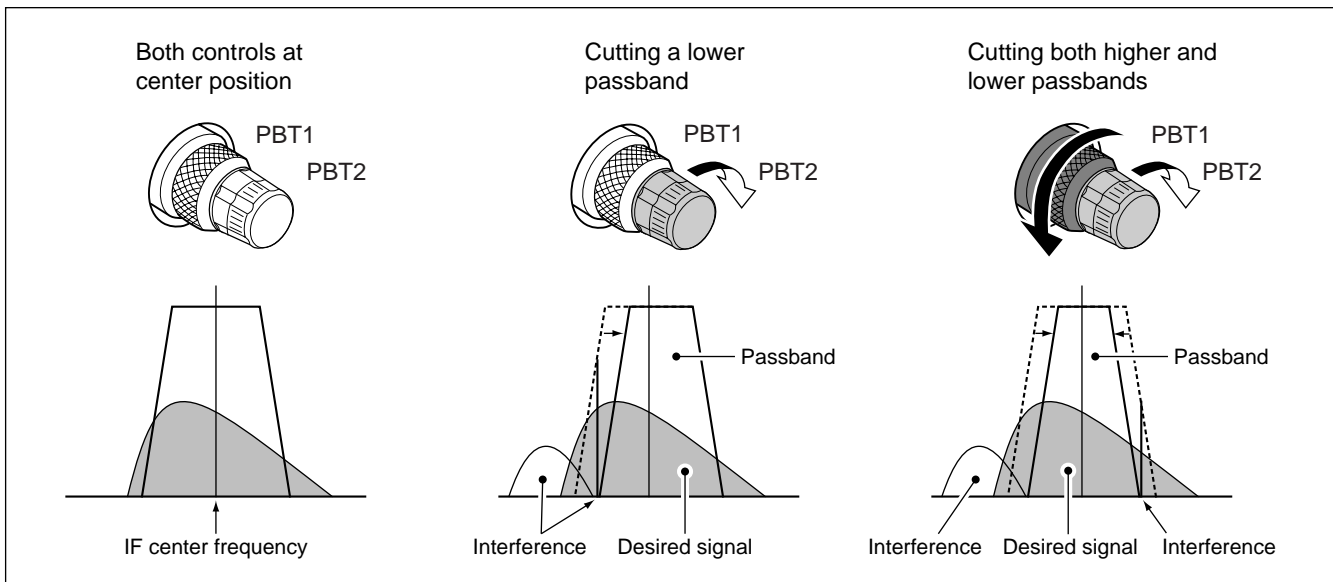

■ IF filter selection

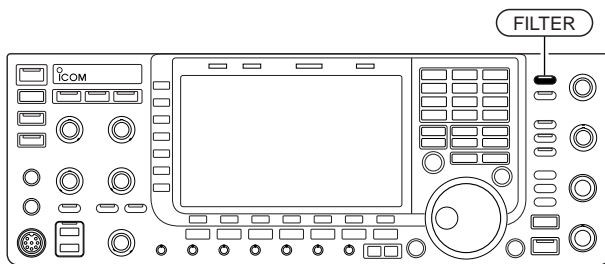

The transceiver has 3 passband width IF filters for each mode.

For SSB, CW and PSK modes, the passband width can be set within 50 to 3600 Hz in 50 or 100 Hz steps. A total of 41 passband widths are available.

For RTTY mode, the passband width can be set within 50 to 2700 Hz in 50 or 100 Hz steps. A total of 32 passband widths are available.

For AM mode, the passband width can be set within 200 Hz to 10 kHz in 200 Hz steps. A total of 50 passband widths are available.

For FM mode, the passband width is fixed and 3 passband widths are available.

▨ The filter selection is automatically memorized in each mode.

▨ The PBT shift frequencies are automatically memorized in each filter.

◇ IF filter selection

① Select the desired mode.

② Push **[FILTER]** several times to select the IF filter 1, 2 or 3.

- The selected passband width and filter number is displayed in the LCD.

◇ Filter passband width setting (except FM mode)



① Push and hold **[FILTER]** for 1 sec. to enter filter set screen.

② Select any mode except FM.

- Passband widths for FM modes are fixed and cannot be set.

③ Push **[FILTER]** several times to select the desired IF filter.

④ While pushing **[F-1•BW]**, rotate the main dial to set the desired passband width.

- In SSB, CW and PSK modes, the passband width can be set within the following range.

50 to 500 Hz 50 Hz steps
600 to 3600 Hz 100 Hz steps

- In RTTY mode, the passband width can be set within the following range.

50 to 500 Hz 50 Hz steps
600 to 2700 Hz 100 Hz steps

- In AM mode, the passband width can be set within the following range.

200 Hz to 10 kHz 200 Hz steps

- Push and hold **[F-4•DEF]** for 1 sec. to select the default value.

⑤ Repeat steps ② to ④ if desired for other modes.

⑥ Push **[EXIT/SET]** to exit filter set screen.

▨ The PBT shift frequencies are cleared when the passband width is changed.

▨ This filter set screen graphically displays the PBT shift frequencies and CW pitch operations.

5 FUNCTIONS FOR RECEIVE

◇ Roofing filter selection



The IC-7700 has 3, 6 and 15 kHz roofing filters at the 1st IF frequency. The roofing filter provides interference reduction from nearby strong signals.

- ① Push and hold **[FILTER]** for 1 sec. to enter filter set screen.
- ② Select any mode except FM.
- ③ Push **[F-6•ROOFING]** to select the desired filter width from 15 kHz (default), 6 kHz and 3 kHz.
 - Push and hold **[F-4•DEF]** for 1 sec. to select a default value.
- ④ Push **[EXIT/SET]** to exit filter set screen.

◇ DSP filter shape



The type of DSP filter shape for each SSB, SSB data and CW can be selected independently from soft and sharp.

- ① Push and hold **[FILTER]** for 1 sec. to enter filter set screen.
- ② Select SSB, SSB data or CW mode.
- ③ Push **[F-7•SHAPE]** to select the desired filter shape from soft and sharp.
- ④ Push **[EXIT/SET]** to exit filter set screen.

The filter shape can be set for each band (HF and 50 MHz bands), mode, as well as the passband width setting (CW only) independently from your default setting in filter shape set mode.

◇ Filter shape set mode

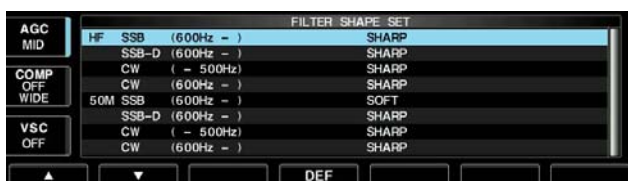

The type of DSP filter shape for SSB, SSB data and CW can be selected independently from soft and sharp.

- ① Push and hold **[FILTER]** for 1 sec. to enter filter set screen.
- ② Push and hold **[F-7•SHAPE]** for 1 sec. to enter filter shape set mode.
- ③ Push **[F-1•▲]** or **[F-2•▼]** to select the desired item.
- ④ Rotate the main dial to select the filter shape from soft and sharp.
- ⑤ Push **[EXIT/SET]** to exit filter shape set mode.

HF SSB (600Hz -)

Select the filter shape for SSB mode in HF bands.

SHARP

▨ The set filter shape is automatically used only when the IF filter is set to 600 Hz or wider.

SSB-D (600Hz -)

Select the filter shape for SSB data mode in HF bands.

SHARP

▨ The set filter shape is automatically used only when the IF filter is set to 600 Hz or wider.

◇ Filter shape set mode (continued)

CW (- 500Hz)

Select the filter shape for CW mode in HF bands.

SHARP

/// The set filter shape is automatically used only when the IF filter is set to 500 Hz or narrower.

CW (600Hz -)

Select the filter shape for CW mode in HF bands.

SHARP

/// The set filter shape is automatically used only when the IF filter is set to 600 Hz or wider.

50M SSB (600Hz -)

Select the filter shape for SSB mode in 50 MHz band.

SOFT

/// The set filter shape is automatically used only when the IF filter is set to 600 Hz or wider.

SSB-D (600Hz -)

Select the filter shape for SSB data mode in 50 MHz band.

SHARP

/// The set filter shape is automatically used only when the IF filter is set to 600 Hz or wider.

CW (- 500Hz)

Select the filter shape for CW mode in 50 MHz band.

SHARP

/// The set filter shape is automatically used only when the IF filter is set to 500 Hz or narrower.

CW (600Hz -)

Select the filter shape for CW mode in 50 MHz band.

SHARP

/// The set filter shape is automatically used only when the IF filter is set to 600 Hz or wider.

■ Noise blanker

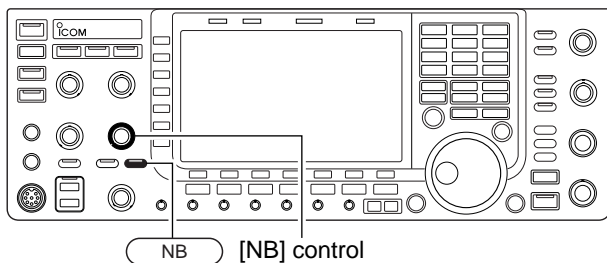

The noise blanker eliminates pulse-type noise such as the noise from car ignitions. The noise blanker is not available for FM mode.

- ① Push **[NB]** to turn the noise blanker function ON and OFF.
 - [NB] indicator above this switch lights green.
- ② Rotate [NB] control to adjust the noise blanker threshold level.

⚠ When using the noise blanker, received signals may be distorted if they are excessively strong or the noise type is other than impulse. Turn the noise blanker OFF, or rotate [NB] control to a shallow position in this case.

◇ NB set mode



To deal with various type of noises, attenuation level and noise blank time can be set in NB set mode.

- ① Push and hold **[NB]** for 1 sec. to enter NB set mode.
- ② Push **[F-1•▲]** or **[F-2•▼]** to select the desired item.
- ③ Rotate the main dial to set the desired level or value.
 - Push and hold **[F-4•DEF]** for 1 sec. to select a default value.
- ④ Push **[EXIT/SET]** to exit NB set mode.

NB Depth		8
Set the noise attenuation level from 1 to 10.		

NB Width		50
Set the blank time from 1 to 100.		

■ Noise reduction

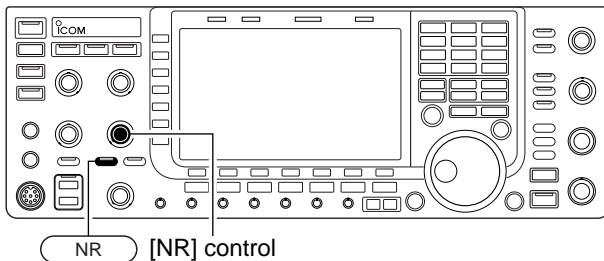

The noise reduction function reduces random noise components and enhances desired signals which are buried in noise. The DSP performs the random noise reduction function.

- ① Push **[NR]** to turn the noise reduction ON.
 - [NR] indicator above this switch lights green.
- ② Rotate the [NR] control to adjust the noise reduction level.
- ③ Push **[NR]** to turn the noise reduction OFF.
 - [NR] indicator lights off.

/// Large rotations of the [NR] control results in audio signal masking or distortion. Set the [NR] control for maximum readability.

■ Dial lock function

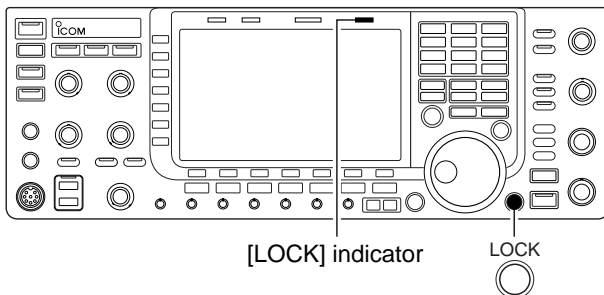

The dial lock function prevents frequency changes by accidental movement of the tuning dial. The lock function electronically locks the dial.

- ➔ Push **[LOCK]** to toggle the dial lock function ON and OFF.
 - The [LOCK] indicator lights when the dial lock function is in use.

Notch function

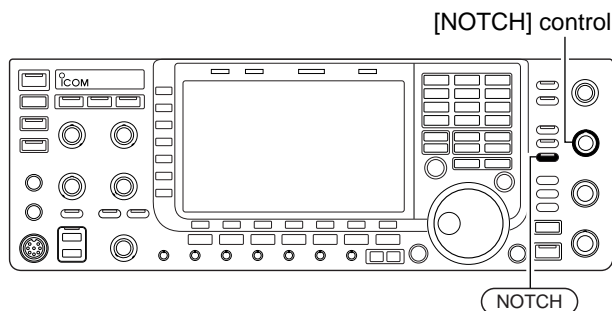

• Auto notch indication



• Manual notch indication



This transceiver has auto and manual notch functions. The auto notch function uses DSP to automatically attenuate more than 3 beat tones, tuning signals, etc., even if they are moving. The manual notch can be set to attenuate a frequency via the [NOTCH] control. The auto notch can be used in SSB, AM and FM mode. The manual notch can be used in SSB, CW, RTTY, PSK and AM modes.

- Push [NOTCH] to toggle the notch function between auto, manual and OFF in SSB and AM modes.
- Push [NOTCH] to turn the manual notch function ON and OFF in CW, RTTY, PSK modes.
- Push [NOTCH] to turn the auto notch function ON and OFF in FM mode.
 - [NOTCH] indicator above this switch lights green.
 - Push and hold [NOTCH] for 1 sec. to select the notch filter width for manual notch from wide, middle and narrow.
 - Set to attenuate a frequency for manual notch via the [NOTCH] control.
 - “AN” appears when auto notch is in use.
 - “MN” appears when manual notch is in use.

⚡ While tuning the manual notch, noise may be heard. This comes from the DSP unit and does not indicate an equipment malfunction.

Digital selector

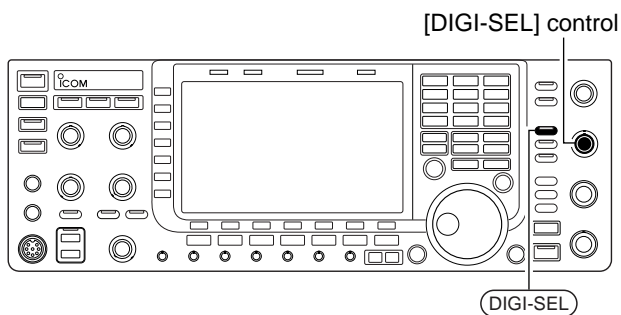

The digital selector manually adjusts the center frequency of the automatic pre-selector.

The automatic pre-selector adds selectivity ahead of the 1st mixer. This reduces intermodulation distortion from the nearby strong signals.

The automatic pre-selector tracks the frequency tuning, changing its resonant frequency in discrete steps.

- ① Push [DIGI-SEL] to turn the digital selector ON and OFF.
 - [DIGI-SEL] indicator above this switch lights green.
- ② Rotate [DIGI-SEL] control to adjust the center frequency.

NOTE:

- When rotating the main dial while the digital selector is activated, mechanical noise may be heard due to the switching noise from internal relays.
- The preamp (P.AMP1 or P.AMP2) cannot be used while the digital selector is activated.

■ Autotune function

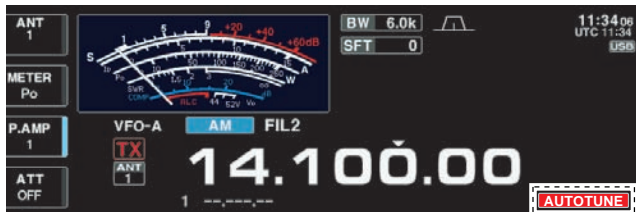
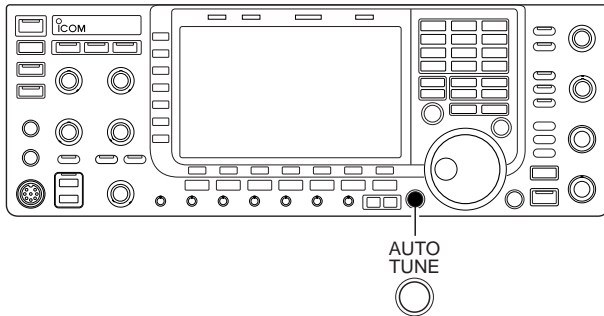

Appears

The Automatic tuning function tunes the displayed frequency (max. CW: 500 Hz, AM: ± 5 kHz) automatically when an off frequency signal is received. This function is active while in CW or AM mode is selected.

➔ Push [AUTOTUNE] to toggle the autotune function ON or OFF.

- "AUTOTUNE" blinks when autotune function is activate.
- After 30 sec. has passed, the autotune function stops tuning automatically even it's still off-frequency.

■ VOX function	6-2
◇ Using the VOX function	6-2
◇ Adjusting the VOX function	6-2
◇ VOX set mode	6-2
■ Break-in function	6-3
◇ Semi break-in operation	6-3
◇ Full break-in operation	6-3
■ ΔTX function	6-4
◇ ΔTX monitor function	6-4
■ Monitor function	6-4
■ Transmit filter width setting (SSB only)	6-5
■ Speech compressor (SSB only)	6-5
■ Split frequency operation	6-6
■ Quick split function	6-7
◇ Split lock function	6-7

■ VOX function

The VOX (Voice-Operated Transmission) function switches between transmit and receive with your voice. This function provides “hands-free” operation.

◇ Using the VOX function

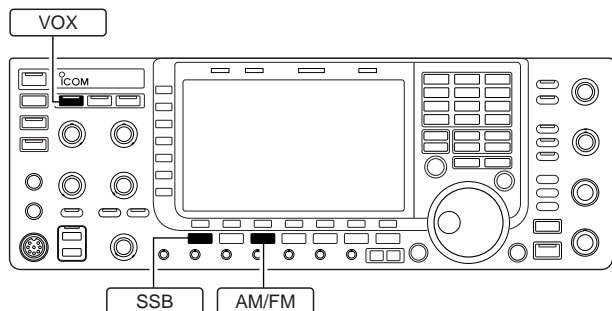

- ① Select a phone mode (SSB, AM, FM).
- ② Push **VOX** to turn the VOX function ON or OFF.
 - “**VOX**” appears while the VOX is in use.
 - [VOX] indicator above this switch lights green.

◇ Adjusting the VOX function

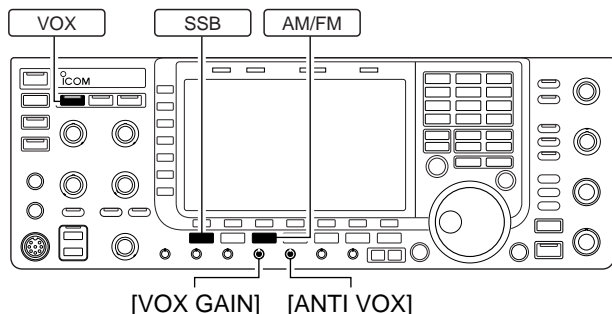

- ① Select a phone mode (SSB, AM, FM).
- ② Push **VOX** to turn VOX function ON.
- ③ While speaking into the microphone with your normal voice level, rotate [VOX GAIN] to the point where the transceiver is continuously transmitting.
- ④ During receive, rotate [ANTI VOX] to the point where the transceiver does not switch to transmit due to received audio from the speaker.
- ⑤ Adjust the VOX delay and the VOX voice delay in VOX set mode, if necessary.

◇ VOX set mode



- ① Push and hold **VOX** for 1 sec. to enter VOX set mode.
- ② Select the desired item using [F-1•▲] or [F-2•▼].
- ③ Rotate the main dial to the desired set value or condition.
 - Push and hold [F-4•DEF] for 1 sec. to select a default value.
- ④ Push **EXIT/SET** to exit VOX set mode.

VOX Delay



Set the VOX delay for a convenient interval before returning to receive within 0 to 2.0 sec. range.

VOX Voice Delay

Short

Set the VOX voice delay to prevent unintended transmission of your voice when switching to transmit. Short, Mid., Long and OFF settings are available.

When using the VOX voice delay, turn the TX monitor function OFF to prevent transmitted audio from be echoed.

■ Break-in function

The break-in function is used in CW mode to automatically toggle the transceiver between transmit and receive when keying. The IC-7700 is capable of full break-in or semi break-in.

◇ Semi break-in operation

During semi break-in operation, the transceiver selects transmit when keying, then automatically returns to receive after a pre-set time after you stop sending.

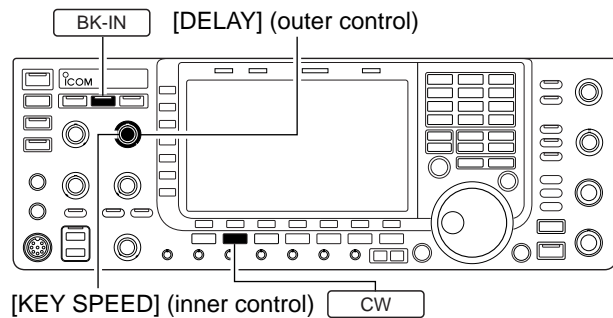

- ① Push **CW** to select CW or CW-R mode.
- ② Push **BK-IN** once or twice to turn the semi break-in function ON.
 - “**BKIN**” appears.
- ③ Rotate **[DELAY]** to set the break-in delay time (the delay from transmit to receive).

▨ When using a paddle, rotate **[KEY SPEED]** to adjust the keying speed.

◇ Full break-in operation

During full break-in operation, the transceiver automatically enters transmit while keying and returns to receive immediately after keying is finished.



- ① Push **CW** to select CW or CW-R mode.
- ② Push **BK-IN** once or twice to turn the full break-in function ON.
 - “**F-BKIN**” appears.

▨ When using a paddle, rotate **[KEY SPEED]** to adjust the keying speed.

■ ΔTX function

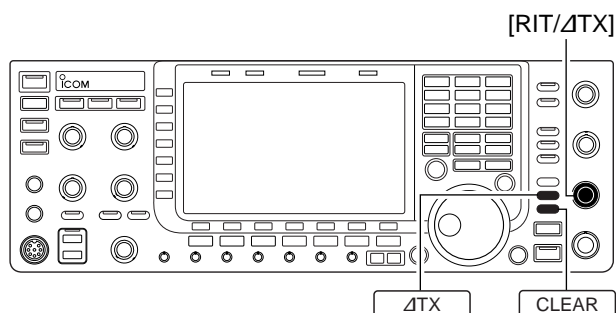

The ΔTX function shifts the transmit frequency up to ±9.999 kHz in 1 Hz steps (10 Hz steps when cancelling the 1 Hz step readout) without moving the receive frequency.

- ① Push **[ΔTX]**.
 - “ΔTX” appears.
- ② Rotate [RIT/ΔTX].
- ③ To reset the ΔTX frequency, push and hold **[CLEAR]** for 1 sec.
 - Push **[CLEAR]** momentarily to reset the ΔTX frequency when the quick RIT/ΔTX clear function is ON. (p. 12-15)
- ④ To cancel the ΔTX function, push **[ΔTX]** again.
 - “ΔTX” disappears.

◇ ΔTX monitor function

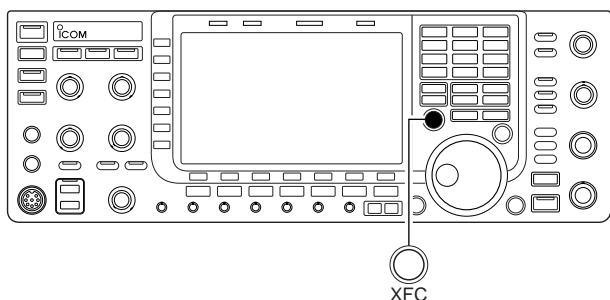

When the ΔTX function is ON, pushing and holding [XFC] allows you to monitor the operating frequency directly (ΔTX is temporarily cancelled).

✓ For your convenience— Calculate function

The shift frequency of the ΔTX function can be added/subtracted to the displayed frequency.

- ➔ While displaying the ΔTX shift frequency, push and hold **[ΔTX]** for 1 sec.

■ Monitor function

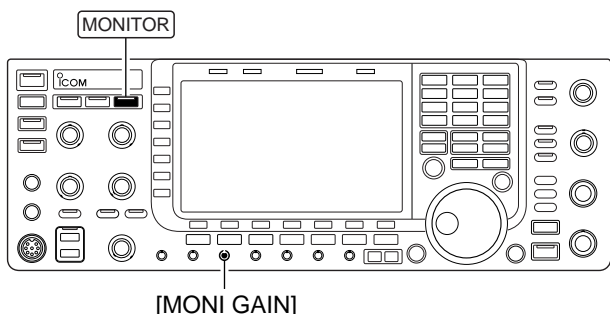

The monitor function allows you to monitor your transmit IF signals in any mode. Use this to check voice characteristics while adjusting SSB transmit parameter (p. 12-5). The CW sidetone functions regardless of the **[MONITOR]** switch setting.

- ① Push **[MONITOR]** to switch the monitor function ON and OFF.
 - [MONITOR] indicator above this switch lights green.
- ② Rotate [MONI GAIN] for the clearest audio output while pushing [PTT] and speaking into the microphone.

NOTE: When using the VOX voice delay, turn the monitor function OFF; or transmitted audio will be echoed.

■ Transmit filter width setting (SSB only)

The transmit filter width for SSB mode can be selected from wide, middle and narrow.

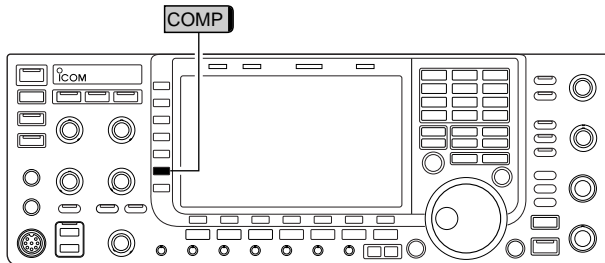

➔ During USB or LSB mode selection, push and hold [COMP] (MF6) for 1 sec. several times to select the desired transmit filter width from wide, middle and narrow.

- The filter can be independently set on the speech compressor function is ON and OFF.

- The following filters are specified as the default. Each of the filter width can be re-set in level set mode. (p. 12-6)

WIDE : 100 Hz to 2.9 kHz

MID : 300 Hz to 2.7 kHz

NAR : 500 Hz to 2.5 kHz

■ Speech compressor (SSB only)

The speech compressor increases average RF output power, improving signal strength and readability in SSB mode only.

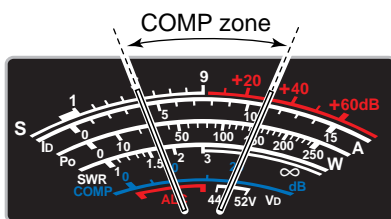
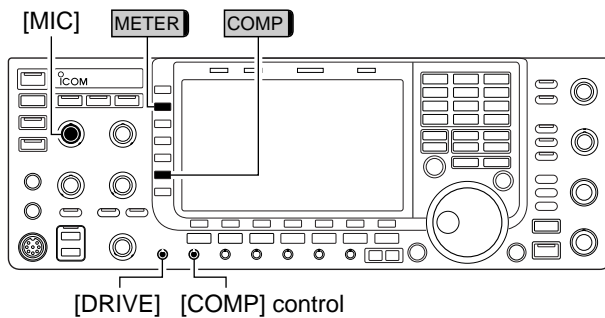

① Select USB or LSB mode and adjust [MIC] to a suitable level.

- Push [METER] (MF2) several times to select the ALC meter for microphone gain adjustment.

② Push [COMP] (MF6) to turn the speech compressor ON.

③ Push [METER] (MF2) once to select the COMP meter.

④ While speaking into the microphone, rotate [COMP] control, so that the COMP meter reads within the COMP zone (10 to 20 dB range) for your normal voice level.

⚡ When the COMP meter peaks exceed the COMP zone, your transmitted voice may be distorted.

⑤ Push [METER] (MF2) 5 times to select the ALC meter.

⑥ While speaking into the microphone, rotate [DRIVE], so that the ALC meter reads within the 30 to 50% range of the ALC zone with your normal voice level.

✓ For your convenience

Push and hold [METER] (MF2) for 1 sec. to display the multi-function meter that can check the ALC and COMP level at a glance.

Split frequency operation

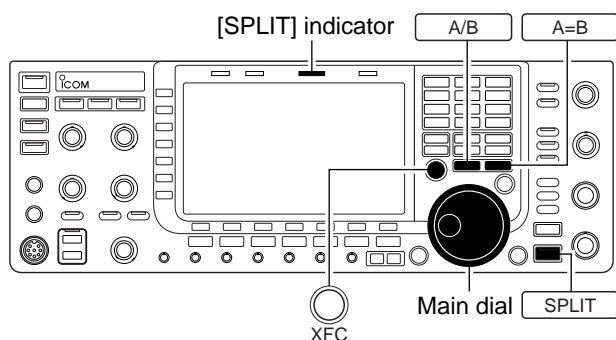

• When the split function ON



• When [XFC] is pushed



• The split frequency operation is ready



Split frequency operation allows you to transmit and receive in the same mode on two different frequencies. Split frequency operation is performed using 2 frequencies on the main and sub readouts.

The following is an example of setting 21.290 MHz for receiving and 21.310 MHz for transmitting.

- ① Set 21.290 MHz (USB) in VFO mode.
- ② Push **[SPLIT]** momentarily, then push and hold **A=B** for 1 sec.
 - The quick split function is much more convenient for selecting the transmit frequency. See the next section for details.
 - The equalized transmit frequency and “**SPLIT**” appear on the LCD.
 - **[SPLIT]** indicator lights.
 - “TX” appears to show the transmit frequency readout.
- ③ Set the transmit frequency to 21.310 MHz in the following way.
 - Rotate the main dial while pushing **[XFC]**.
 - The transmit frequency can be monitored while pushing **[XFC]**.
- ④ Now you can receive on 21.290 MHz and transmit on 21.310 MHz.

To change the transmit and receive frequencies, push **A/B** to exchange the main and sub readouts.

✓ CONVENIENT

• Direct shift frequency input

The shift frequency can be entered directly.

- ① Push **[F-INP ENT]**.
- ② Enter the desired shift frequency with the digit keys.
 - 1 kHz to 1 MHz can be set.
 - When you require a negative shift direction, push **[GENE .]** in advance.
- ③ Push **[SPLIT]**.
 - The shift frequency is input in the sub readout and the split function is turned ON.

[Example]

To transmit on 1 kHz higher frequency:

- Push **[F-INP ENT]**, **[1.8 1]** then **[SPLIT]**.

To transmit on 3 kHz lower frequency:

- Push **[F-INP ENT]**, **[GENE .]**, **[7 3]** then **[SPLIT]**.

• Split lock function

Accidentally releasing **[XFC]** while rotating the main dial changes the receive frequency. To prevent this, use both the split lock and dial lock functions to change the transmit frequency only. The split lock function cancels the dial lock function while pushing **[XFC]** during split frequency operation.

The dial lock's effect during split frequency operation can be selected in the set mode for both receive and transmit frequencies; or only the receive frequency. (p. 12-13)

■ Quick split function

When you find a DX station, an important consideration is how to set the split frequency.

When you push and hold the **[SPLIT]** switch for 1 sec., split frequency operation is turned ON and the transmit frequency is equalized to the received frequency.

This shortens the time needed to begin split frequency operation.

The quick split function is ON by default. For your convenience, it can be turned OFF in Others set mode. (p. 12-12) In this case, the **[SPLIT]** switch does not equalize the transmit frequency to the receive frequency.

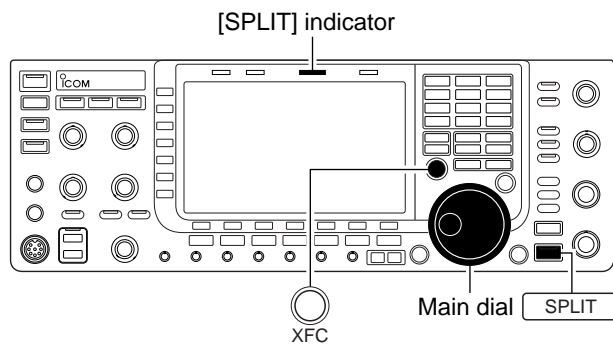

- ① Suppose you are operating at 21.290 MHz (USB) in VFO mode.
- ② Push and hold **[SPLIT]** for 1 sec.
 - Split frequency operation is turned ON.
 - The transmit frequency (unselected VFO's readout) is equalized to the receive frequency (selected VFO's readout).
 - "**F-INP**" indicator appears.
- ③ Enter the desired offset frequency from the keypad then push **[SPLIT]**, or set the transmit frequency with the main dial while pushing **[XFC]**.
 - "**F-INP**" indicator appears when **[F-INP ENT]** is pushed.
 - Offset frequency setting with the keypad— example
To transmit on 1 kHz higher frequency:
 - Push **[F-INP ENT]**, **[1.8 1]** then **[SPLIT]**.
 - To transmit on 3 kHz lower frequency:
 - Push **[F-INP ENT]**, **[GENE .]**, **[7 3]** then **[SPLIT]**.

◇ Split lock function

The split lock function is convenient for changing only the transmit frequency. When the split lock function is not used, accidentally releasing **[XFC]** while rotating the main dial, changes the receive frequency. The split lock function is ON by default, but can be turned OFF in set mode. (p. 12-13)

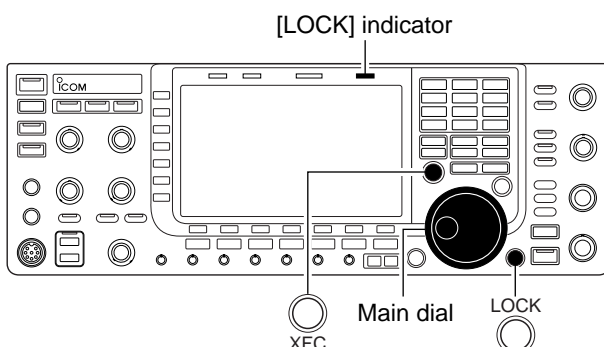

- ① While split frequency operation is ON, push **[LOCK]** to activate the split lock function.
- ② While pushing **[XFC]**, rotate the main dial to change the transmit frequency.
 - If you accidentally release **[XFC]** while rotating the main dial, the receive frequency does NOT change.

■ About digital voice recorder	7-2
■ Recording a received audio	7-3
◇ Basic recording	7-3
◇ One-touch recording	7-3
■ Playing the recorded audio	7-4
◇ Basic playing	7-4
◇ One-touch playing	7-4
■ Protect the recorded contents	7-5
■ Erasing the recorded contents	7-5
■ Recording a message for transmit	7-6
◇ Recording	7-6
◇ Confirming a message for transmit	7-6
■ Programming a memory name	7-7
■ Sending a recorded message	7-8
◇ Transmit level setting	7-8
■ Voice set mode	7-9
■ Saving a voice message into the USB-Memory	7-10
◇ Saving the received audio memory	7-10
◇ Saving the TX memory	7-10

About digital voice recorder

The IC-7700 has digital voice memories, up to 4 messages for transmit, and up to 20 messages for receive. A maximum message length of 30 sec. can be recorded into receive memory (total message length for all channels of up to 209 sec.) and a total message length of up to 99 sec. can be recorded in transmit memory.

The transmit memory is very convenient for repeated CQ and exchange transmissions in contests, as well as when making consecutive calls to DXpeditions.

- ① Select any mode.
- ② Push [F-2•VOICE] to display voice recorder screen.
- ③ Push [EXIT/SET] to display voice recorder menu.
- ④ Push [F-1•PLAY] or [F-2•MIC REC] to select the desired memory channel screen, then record audio or playback the contents as described below.
- ⑤ Push [EXIT/SET] twice to exit voice recorder screen.

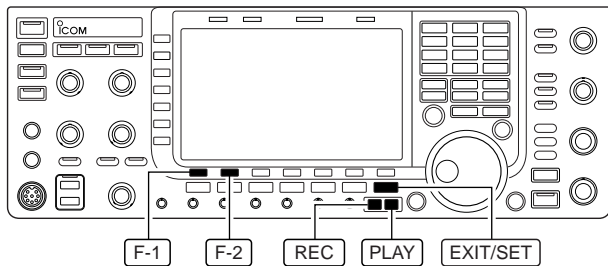

• Example— When [REC] is pushed and held for 1sec.

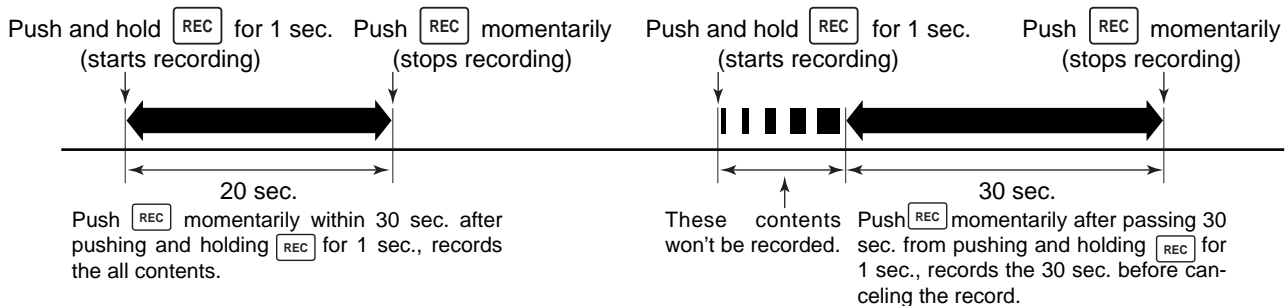

• Example— When [REC] is pushed momentarily

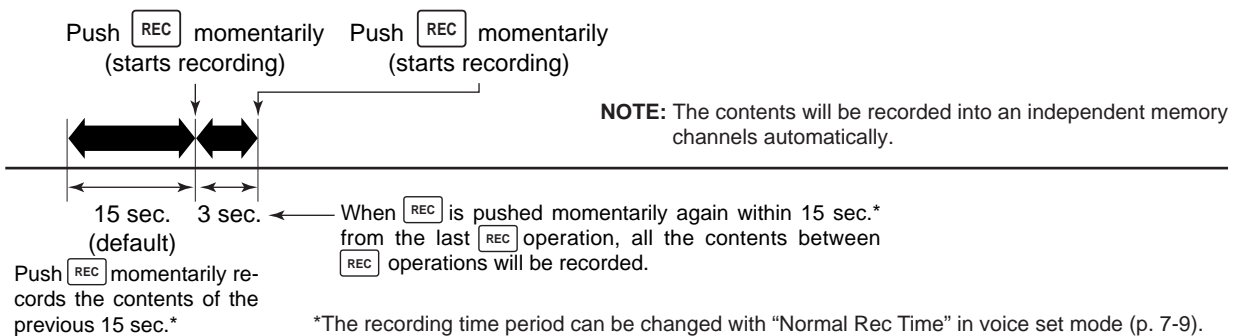

• Playing back the all contents in a channel

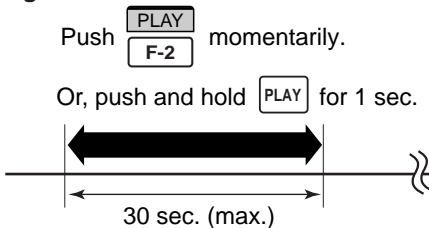

• Playing back the end of 5 sec.* in a channel

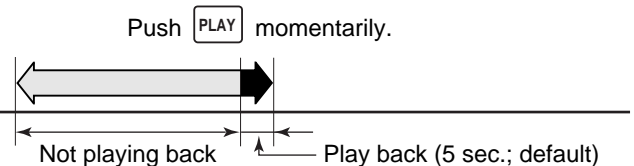

*The playing back time period can be changed with "Short Play Time" in voice set mode (p. 7-9).

Recording a received audio

Up to 20 receive voice memories are available in the IC-7700. A total audio length of up to 209 sec. can be recorded in receive messages. However, the maximum recordable length into a single message is 30 sec.

This voice recorder records not only the received audio, but also the information such as set operating frequency, mode, and the recording time for your future reference.

Basic recording

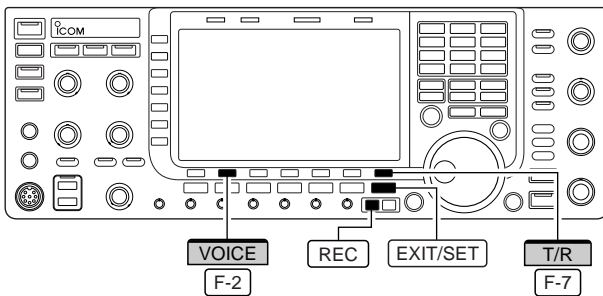

VOICE RECORDER							
AGC	1	24,950.00	USB	7- 2	9:15	2s	
MID	2	24,950.00	USB	7- 2	9:14	11s	
COMP	3	14,100.00	USB	7- 2	9:13	15s	
OFF							
WIDE							
VSC							Remain
OFF							177s
			RX MEMORY				

- ① Push **[EXIT/SET]** several times to close a multi-function screen, if necessary.
- ② Select the desired mode.
- ③ Push **[F-2•VOICE]** to call up the voice recorder screen.
 - Previously selected screen, TX or RX memory, is displayed. If the TX memory channel (T1–T4) appears, push **[F-7•T/R]** to select RX memory channel.
- ④ Push and hold **[REC]** for 1 sec. to start recording.
 - The operating frequency, mode and current time are programmed as the memory names automatically.
- ⑤ Push **[REC]** momentarily to stop recording.

IMPORTANT!

Push **[REC]** to stop recording before, or when 30 sec. has passed from the start of recording. The voice recorder memory records the 30 sec. (max.) of audio before **[REC]** is pushed. For example, when recording 40 sec. of audio, the first 10 sec. audio will be over-written with the last 10 sec., so that the total of audio recorded is only 30 sec. When you record the 21st audio message, or when the total audio length exceeds 209 sec., the oldest recorded audio is automatically erased to make room for the new audio.

- ⑥ Push **[EXIT/SET]** twice to exit the voice recorder screen.

NOTE: When transmit (or [PTT] is pushed) while recording, no audio will be recorded.

One-touch recording

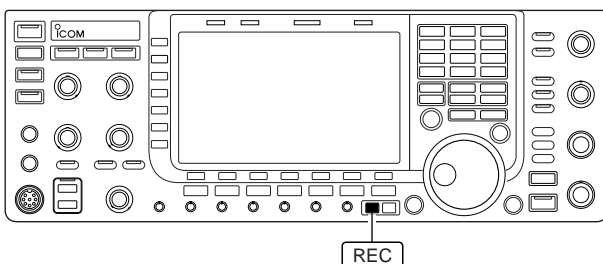

To record the received signal immediately, one-touch voice recording is available.

- ➔ Push **[REC]** momentarily to record the previous 15 sec. audio.
 - The recordable time period can be set in voice set mode. (p. 7-9)

■ Playing the recorded audio

◇ Basic playing

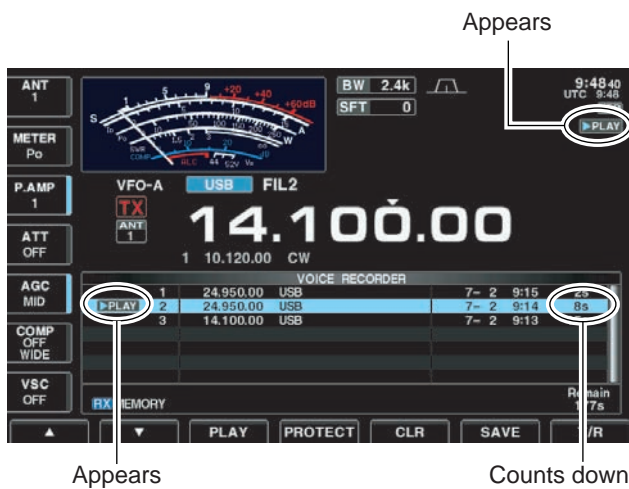
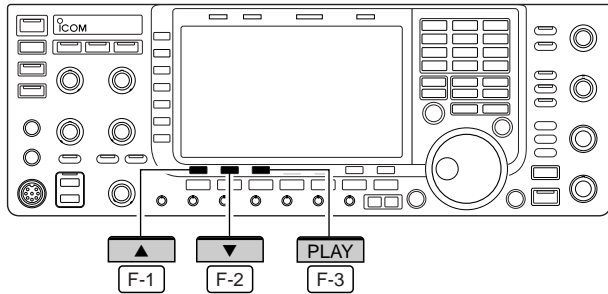

- ① Push [EXIT/SET] several times to close a multi-function screen, if necessary.
- ② Push [F-2•VOICE] to call up the voice recorder screen.
 - Previously selected screen, TX or RX memory, is displayed. If the TX memory message (T1–T4) appears, push [F-7•T/R] to select RX memory message.
- ③ Push [F-1•▲] or [F-2•▼] to select the desired voice memory to playback.
- ④ Push [F-3•PLAY] to start playback.
 - “▶PLAY” indicators appear and the timer counts down.
- ⑤ Push [F-3•PLAY] again to stop playback if desired.
 - Playback is terminated automatically when all of the recorded contents in the message are played, or after 30 sec.
- ⑥ Push [EXIT/SET] twice to exit the voice recorder screen.

◇ One-touch playing

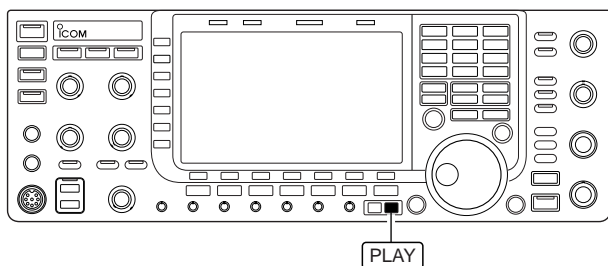

The previously recorded audio in message 1 can be played back without selecting voice recorder screen.

- Push [PLAY] momentarily to play back the last 5 sec. of the previously recorded audio.
 - “▶PLAY” indicator appears.
 - Playback is terminated automatically when all of the recorded contents in the message are played, or after 5 sec.
 - The playback time period can be set in voice set mode. (p. 7-9)

■ Protect the recorded contents

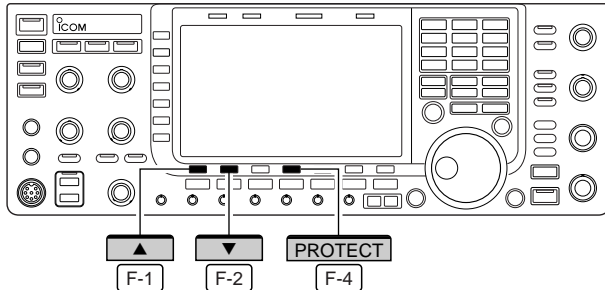

The protect function is available to protect the recorded contents from accidental erasure, such as over-writing, etc.

- ① Call up the voice recorder screen, RX memory.
- ② Push [F-1•▲] or [F-2•▼] to select the desired voice message.
- ③ Push [F-4•PROTECT] to turn the protect function ON and OFF.
 - “” indicator appears when the contents is protected.
- ④ Push [EXIT/SET] twice to exit the voice recorder screen.

■ Erasing the recorded contents

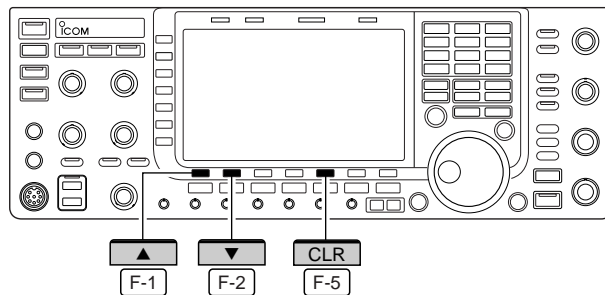

The recorded contents can be erased independently by message.

- ① Call up the voice recorder screen, RX memory.
- ② Push [F-1•▲] or [F-2•▼] to select the desired voice message to be erased.
- ③ Push and hold [F-5•CLR] for 1 sec. to erase the contents.
 - Push [F-4•PROTECT] to release the protection in advance if necessary.
- ④ Push [EXIT/SET] twice to exit the voice recorder screen.

Recording a message for transmit

To transmit a message using the voice recorder, record the desired message in advance as described below. The IC-7700 has digital voice memories for transmission, up to 4 messages and a total message length of up to 99 sec. can be recorded.

Recording

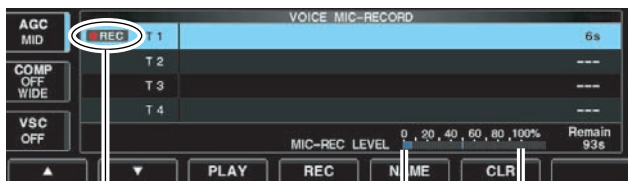
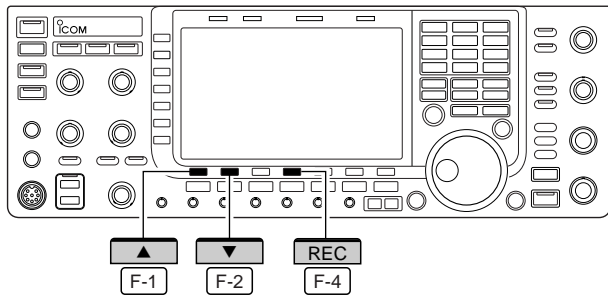

Appears

Adjust [MIC] control so that this indicator reads within 100%.

- ① Push [EXIT/SET] several times to close a multi-function screen, if necessary.
- ② Push [F-2•VOICE] to call up the voice recorder screen.
- ③ Push [EXIT/SET] to select voice recorder menu.
- ④ Push [F-2•MIC REC] to select the voice mic. record screen.
- ⑤ Push [F-1•▲] or [F-2•▼] to select the desired message.
- ⑥ Push and hold [F-4•REC] for 1 sec. to start recording.
 - “**REC**” indicator appears.
 - Speak into the microphone without pushing [PTT].
 - Previously recorded contents are cleared.
 - Audio output from the internal speaker is automatically muted.
- ⑦ While speaking into the microphone with your normal voice level, adjust the [MIC] control so that the [MIC-REC LEVEL] indicator reads within 100%.
- ⑧ Push [F-4•REC] momentarily to stop recording.
 - The recording is terminated automatically when the remaining time becomes 0 sec.
- ⑨ Push [EXIT/SET] twice to exit the voice recorder screen.

Confirming a message for transmit

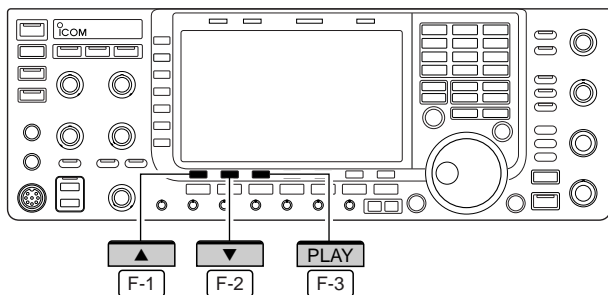

- ① Perform the steps ① to ④ as “◇ Recording” above.
- ② Push [F-1•▲] or [F-2•▼] to select the desired message.
- ③ Push [F-3•PLAY] to playback the recorded contents.
 - “**▶PLAY**” indicator appears.
- ④ Push [F-3•PLAY] again to stop playback.
 - Playback is terminated automatically when all of the recorded contents in the message are played.
- ⑤ Push [EXIT/SET] twice to exit the voice recorder screen.

■ Programming a memory name

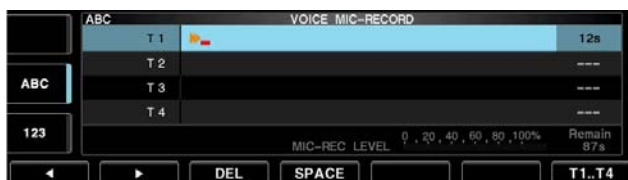
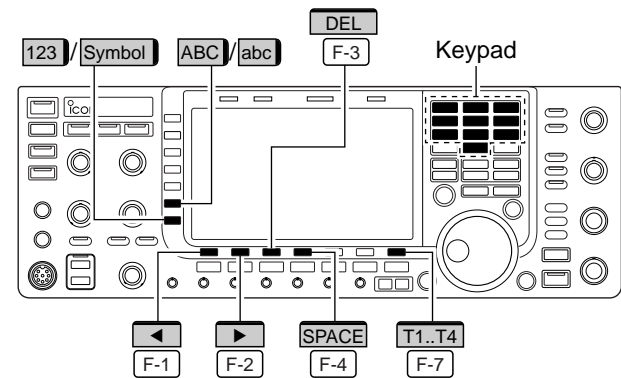

• Voice memory name editing example



Memory messages can be tagged with alphanumeric names of up to 20 characters each.

Capital letters, small letters, numerals, some symbols (! # \$ % & ¥ ? “ ` ^ + - * / . , ; = < > () [] { } | _ ~ @) and spaces can be used. (See the table below.)

- ① Record a message as described in page 7-6.
- ② During the voice mic. record screen indication, push [F-5•NAME] to enter memory name edit condition.
 - A cursor appears and blinks.
- ③ Push [F-7•T1..T4] several times to select the desired voice message.
- ④ Input the desired character by rotating the main dial or by pushing the band key for number input.
 - Push [ABC] (MF6) or [abc] (MF6) to toggle capital and small letters.
 - Push [123] (MF7) or [Symbol] (MF7) to toggle numerals and symbols.
 - Push [F-1•◀] or [F-2•▶] for cursor movement.
 - Push [F-3•DEL] to delete the selected character.
 - Push [F-4•SPACE] to input a space.
 - Pushing the transceiver’s keypad, [0]–[9], can also enter numerals.
- ⑤ Push [EXIT/SET] to input and set the name.
 - The cursor disappears.
- ⑥ Repeat steps ③ to ⑤ to program another voice message’s name, if desired.
- ⑦ Push [EXIT/SET] twice to exit the voice recorder screen.

• Usable characters

Key selection	Editable characters
ABC	A to Z (capital letters)
abc	a to z (small letters)
123	0 to 9 (numbers)
Symbol	! # \$ % & ¥ ? “ ` ^ + - * / . , ; = < > () [] { } _ ~ @

■ Sending a recorded message

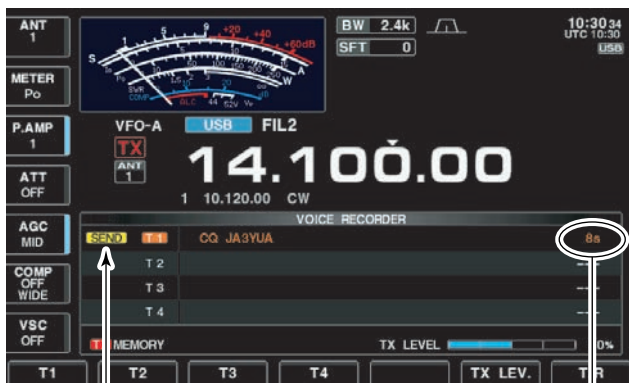
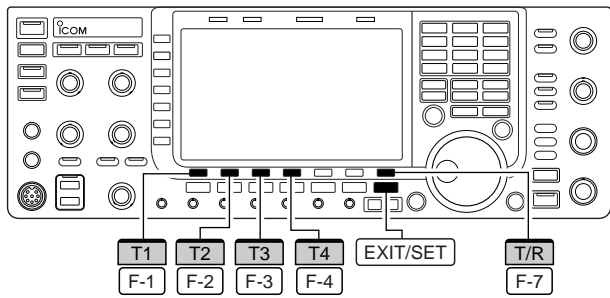

Appears

Counts down

- ① Push [EXIT/SET] several times to close a multi-function screen, if necessary.
- ② Select a phone mode by pushing [SSB] or [AM/FM].
- ③ Push [F-2•VOICE] to call up the voice recorder screen.
 - If the receive voice message appears, push [F-7•T/R] to select TX message (T1–T4).
- ④ Push the desired message switch, [F-1•T1] to [F-4•T4], momentarily to transmit the contents.
 - The transceiver transmits automatically.
 - “SEND” indicator appears and the memory timer counts down.
 - You hear the transmitted message from the speaker as the default. This can be turned OFF in voice set mode. (p. 7-9)
- ⑤ Push the selected message switch, [F-1•T1] to [F-4•T4], again to stop, if desired.
 - The transceiver returns to receive automatically when all of the recorded contents in the message are transmitted.
- ⑥ Push [EXIT/SET] twice to exit the voice memory screen.

✓ For your information

When an external keypad is connected to [EXT KEYPAD], the recorded message, T1–T4, can be transmitted without opening the voice recorder screen. See page 2-7 for details.

◇ Transmit level setting

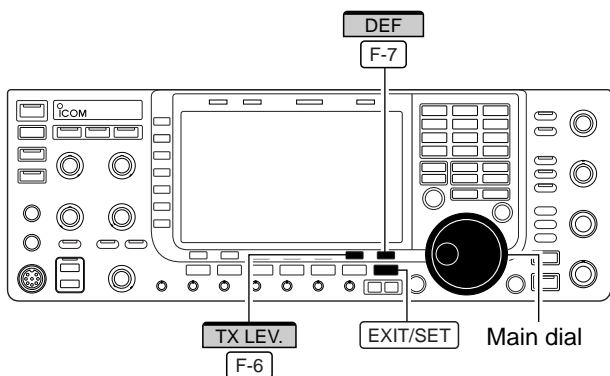

- ① Call up the voice recorder screen as described as above.
- ② Push [F-6•TX LEV.] to select the voice memory transmit level set condition.
- ③ Push the desired message switch, [F-1•T1] to [F-4•T4], momentarily to transmit the contents.
 - The transceiver transmits automatically.
 - “SEND” indicator appears and the memory timer counts down.
- ④ Rotate the main dial to adjust the transmit voice level.
 - Push and hold [F-7•DEF] for 1 sec. to select the default condition.
- ⑤ Push [EXIT/SET] to return to the voice recorder screen.

■ Voice set mode

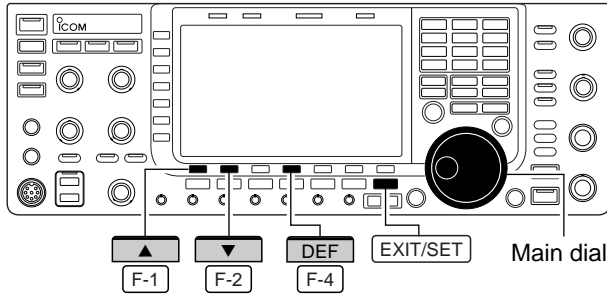

Sets the automatic monitor function, short play and normal recording times for voice recorder.

- ① Push [EXIT/SET] several times to close a multi-function screen, if necessary.
- ② Push [F-2•VOICE] to call up the voice recorder screen.
- ③ Push [EXIT/SET] to select voice recorder menu.
- ④ Push [F-7•SET] to select voice set mode screen.
- ⑤ Push [F-1•▲] or [F-2•▼] to select the desired item.
- ⑥ Rotate the main dial to set the desired condition or value.
 - Push and hold [F-4•DEF] for 1 sec. to select the default condition or value.
- ⑦ Push [EXIT/SET] to exit the voice set mode screen.

Auto Monitor

ON

Turn the automatic monitor function for recorded audio contents transmission.

- ON : Monitors transmitting audio automatically when sending a recorded audio.
- OFF : Monitors transmitting audio only when the monitor function is in use.

Short Play Time

5s

Set the desired time period for the one-touch playing (when [PLAY] is pushed momentarily).

- 3 to 10 sec. in 1 sec. steps can be set. (default: 5 sec.)

Normal Rec Time

15s

Set the desired time period for the for one-touch recording (when [REC] is pushed momentarily).

- 5 to 15 sec. in 1 sec. steps can be set. (default: 15 sec.)

■ Saving a voice message into the USB-Memory

◇ Saving the received audio memory

The USB-Memory is not supplied by Icom.

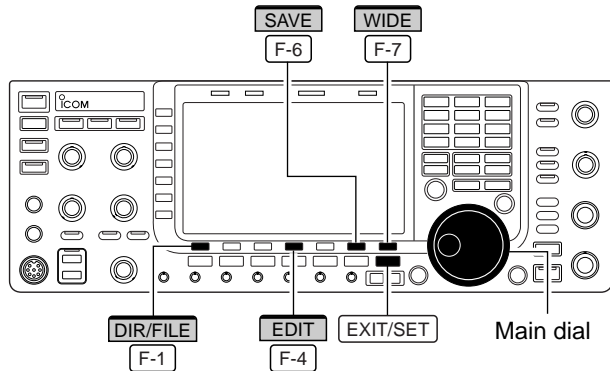

• Voice recorder RX memory screen



• Voice file save screen— file name edit



• While saving



◇ Saving the TX memory

The recorded RX memory contents can be saved into the USB-Memory.

- During voice recorder RX memory screen display, push [F-6•SAVE] to select voice file save screen.
 - Previously selected screen, TX or RX memory, is displayed. If the TX message (T1–T4) appears, push [F-7•T/R] to select RX message.
- Change the following conditions if desired.



• File name:

- Push [F-4•EDIT] to select file name edit condition.
 - Push [F-1•DIR/FILE] several times to select the file name, if necessary.
- Push [ABC] (MF6), [123] (MF7) or [Symbol] (MF7) to select the character group, then rotate the main dial to select the character.
 - [ABC] (MF6) : A to Z (capital letters); [123] (MF7): 0 to 9 (numerals); [Symbol] (MF7): ! # \$ % & ' ` ^ + - = () [] { } _ ~ @ can be selected.
 - Push [F-1•◀] to move the cursor left, push [F-2•▶] to move the cursor right, push [F-3•DEL] to delete a character and push [F-4•SPACE] to insert a space.
- Push [EXIT/SET] to set the file name.

• Saving location

- Push [F-1•DIR/FILE] to select tree view screen.
 - Select the desired directory or folder in the USB-Memory.
 - Push [F-4•◀▶] to select the upper directory.
 - Push [F-2•▲] or [F-3•▼] to select folder in the same directory.
 - Push and hold [F-4•◀▶] for 1 sec. to select a folder in the directory.
 - Push [F-5•REN/DEL] to rename the folder.
 - Push and hold [F-5•REN/DEL] for 1 sec. to delete the folder.
 - Push and hold [F-6•MAKE] for 1 sec. to making a new folder. (Edit the name with the same manner as the “• File name” above.)
 - Push [F-1•DIR/FILE] twice to select the file name.
- Push [F-6•SAVE].
 - After the saving is completed, return to voice recorder RX memory screen automatically.

The TX memory contents can also be saved into the USB-Memory. However, the contents are saved with the message list, set mode conditions, etc. at the same time. See page 12-22 for details.

■ Memory channels	8-2
■ Memory channel selection	8-2
◇ Using the  /  keys	8-2
◇ Using the keypad	8-2
■ Memory channel programming	8-3
◇ Programming in VFO mode	8-3
◇ Programming in memory mode	8-3
■ Frequency transferring	8-4
◇ Transferring in VFO mode	8-4
◇ Transferring in memory mode	8-4
■ Memory list screen	8-5
◇ Selecting a memory channel using the memory list screen	8-5
◇ Confirming programmed memory channels	8-5
■ Memory names	8-6
◇ Editing (programming) memory names	8-6
■ Memory clearing	8-6
■ Memo pads	8-7
◇ Writing frequencies and operating modes into memo pads	8-7
◇ Calling up a frequency from a memo pad	8-7

Memory channels

The transceiver has 101 memory channels. Memory mode is very useful for quickly changing to often-used frequencies.

All 101 memory channels are tunable which means the programmed frequency can be tuned temporarily with the main dial, etc. in memory mode.

MEMORY CHANNEL	MEMORY CHANNEL NUMBER	CAPABILITY	TRANSFER TO VFO	OVER-WRITING	CLEAR
Regular memory channels	1-99	One frequency and one mode in each memory channel.	Yes	Yes	Yes
Scan edge memory channels	P1, P2	One frequency and one mode in each memory channel as scan edges for programmed scan.	Yes	Yes	No

Memory channel selection

Using the ▲ / ▼ keys

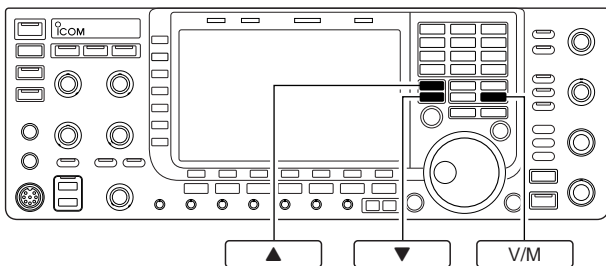

- ① Push **V/M** to select memory mode.
- ② Push **▲** / **▼** several times to select the desired memory channel.
 - Push and hold **▲** / **▼** for continuous selection.
 - [UP] and [DN] on the microphone can also be used.
- ③ To return to VFO mode, push **V/M** again.

Using the keypad

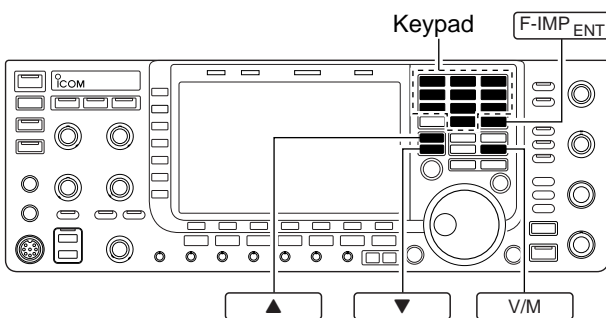

- ① Push **V/M** to select memory mode.
- ② Push **F-INP ENT**.
- ③ Push the desired memory channel number using the keypad.
 - Enter 100 or 101 to select scan edge channel P1 or P2, respectively.
- ④ Push **▲** or **▼** to select the desired memory channel.

[EXAMPLE]

To select the memory channel 3;

- Push **F-INP ENT**, **7 3**, then push **▲** or **▼**.

To select the memory channel 12;

- Push **F-INP ENT**, **1.8 1**, **3.5 2**, then push **▲** or **▼**.

To select the scan edge channel P1;

- Push **F-INP ENT**, **1.8 1**, **50 0**, **50 0**, then push **▲** or **▼**.

To select the scan edge channel P2;

- Push **F-INP ENT**, **1.8 1**, **50 0**, **1.8 1**, then push **▲** or **▼**.

Memory channel programming

Memory channel programming can be performed either in VFO mode or in memory mode.

◇ Programming in VFO mode

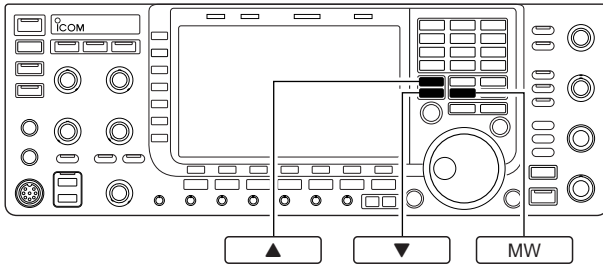

[EXAMPLE]:
Programming 7.088 MHz/LSB into memory channel 12.

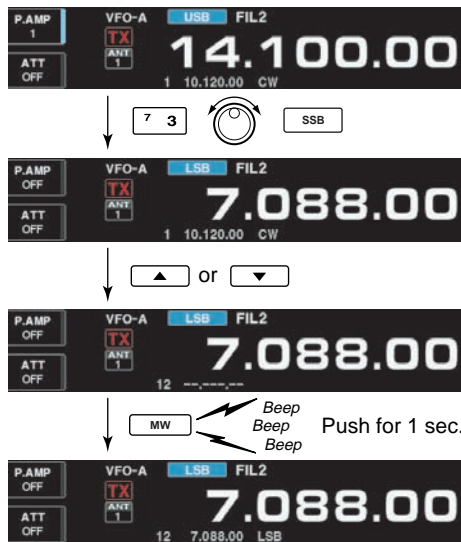

- ① Set the desired frequency, operating mode and filter width in VFO mode.
- ② Push / several times to select the desired memory channel.
 - Memory list screen is convenient for selecting the desired channel.
 - Memory channel contents appear in the memory channel readout (below the frequency readout).
 - “--.--.--” appears if the selected memory channel is a blank channel (and does not have contents).
- ③ Push and hold for 1 sec. to program the displayed frequency, operating mode, etc., into the memory channel.

◇ Programming in memory mode

[EXAMPLE]:
Programming 21.280 MHz/USB into memory channel 18.

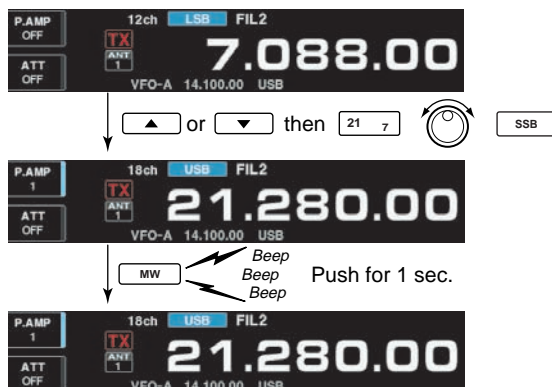

- ① Select the desired memory channel with / in memory mode.
 - Memory channel contents appear in the memory channel readout (below the frequency readout).
 - “--.--.--” appears if the selected memory channel is a blank channel (and does not have contents).
- ② Set the desired frequency and operating mode in memory mode.
 - To program a blank channel, use direct frequency entry with the keypad or memo pads, etc.
- ③ Push and hold for 1 sec. to program the displayed frequency and operating mode into the memory channel.

Frequency transferring

Transferring in VFO mode

TRANSFERRING EXAMPLE IN VFO MODE

Operating frequency : 21.320 MHz/USB (VFO)
 Contents of M-ch 16 : 14.018 MHz/CW

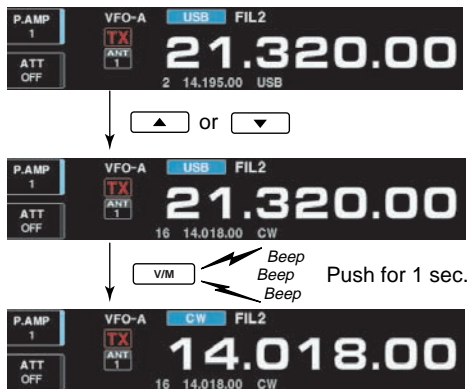

Transferring in memory mode

TRANSFERRING EXAMPLE IN MEMORY MODE

Operating frequency : 21.320 MHz/USB (M-ch 16)
 Contents of M-ch 16 : 14.018 MHz/CW

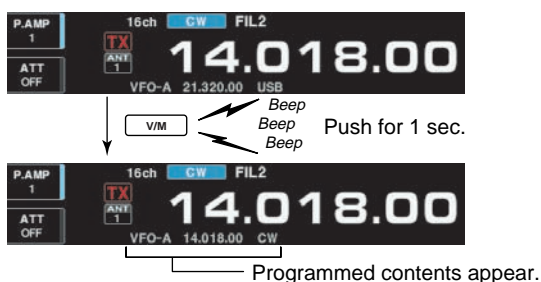

The frequency and operating mode in a memory channel can be transferred to the VFO. Frequency transferring can be performed in either VFO mode or memory mode.

This is useful for transferring programmed contents to a VFO.

- ① Select VFO mode with .
- ② Select the memory channel to be transferred with / .
 - Memory list screen is convenient for selecting the desired channel.
 - Memory channel contents appear in the memory channel readout (below the frequency readout).
 - “---,---,---” appears if the selected memory channel is a blank channel. In this case transferring is not possible.
- ③ Push and hold for 1 sec. to transfer the frequency and operating mode.
 - Transferred frequency and operating mode appear on the frequency readout.

This is useful for transferring frequency and operating mode while operating in memory mode.

- When you have changed the frequency or operating mode in the selected memory channel:
 - **Displayed** frequency, mode and filter setting are transferred.
 - **Programmed** frequency and mode in the memory channel are not transferred, and they remain in the memory channel.

- ① Select the memory channel to be transferred with / in memory mode.
 - And, set the frequency or operating mode if required.
- ② Push and hold for 1 sec. to transfer the frequency and operating mode.
 - Displayed frequency and operating mode are transferred to the VFO.
- ③ To return to VFO mode, push momentarily.

Memory list screen

The memory list screen simultaneously shows 9 memory channels and their programmed contents. 15 memory channels can be displayed in the wide memory list screen.

You can select a desired memory channel from the memory list screen.

Selecting a memory channel using the memory list screen

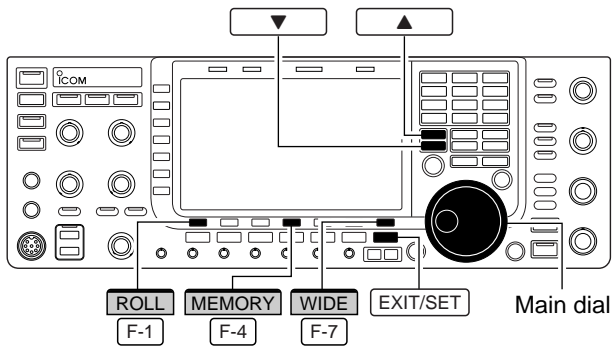

- ① Push [EXIT/SET] several times to close a multi-function screen, if necessary.
- ② Push [F-4•MEMORY] to select memory list screen.
 - [F-7•WIDE] switches the standard and wide screens.
- ③ While pushing and holding [F-1•ROLL], rotate the main dial to select the desired memory channel.
 - ▲ and ▼ can also be used.
- ④ Push [EXIT/SET] to exit memory list screen.

Memory list screen

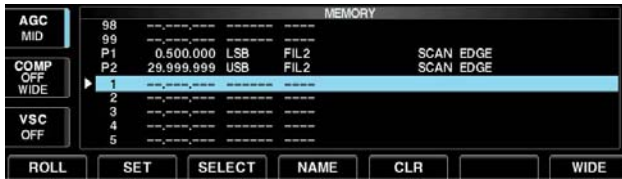

Confirming programmed memory channels

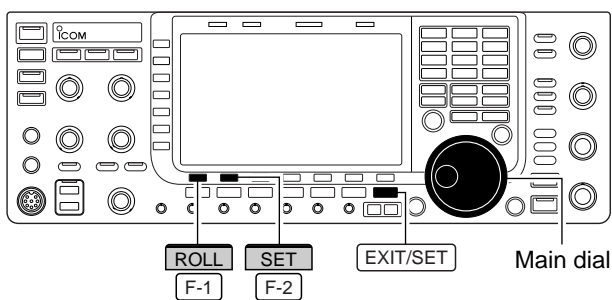

- ① Select memory list screen as described above.
- ② While pushing [F-1•ROLL], rotate the main dial to scroll the screen.
- ③ Push [F-2•SET] to select the highlighted memory channel, if desired.
 - “▶” appears beside the selected memory channel number in the memory list screen and the selected memory channel contents are displayed below the frequency readout.
- ④ Push [EXIT/SET] to exit memory list screen.

Memory names

All memory channels (including scan edges) can be tagged with alphanumeric names of up to 10 characters each.

Capital letters, small letters, numerals, some symbols (! # \$ % & ¥ ? " ' ` ^ + - * / . , ; = < > () [] { } | _ ~ @) and spaces can be used.

Editing (programming) memory names

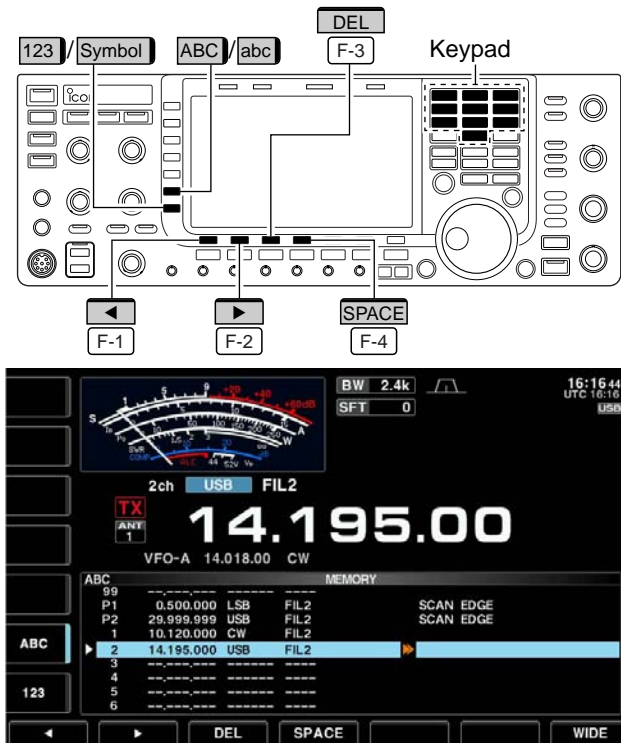

- ① Push [EXIT/SET] several times to close a multi-function screen, if necessary.
- ② Push [F-4•MEMORY] to select memory list screen.
- ③ Select the desired memory channel.
- ④ Push [F-4•NAME] to edit memory channel name.
 - A cursor appears and blinks.
 - Memory channel names of blank channels cannot be edited.
- ⑤ Input the desired character by rotating the main dial or by pushing the keypad for number input.
 - Push [ABC] or [abc] to toggle capital and small letters.
 - Push [123] or [Symbol] to toggle numerals and symbols.
 - Push [F-1•◀] or [F-2•▶] for cursor movement.
 - Push [F-3•DEL] to delete the selected character.
 - Push [F-4•SPACE] to input a space.
 - Pushing the transceiver's keypad, [0]–[9], can also enter numerals.
- ⑥ Push [EXIT/SET] to input and set the name.
 - The cursor disappears.
- ⑦ Repeat steps ③ to ⑥ to program another memory channel's name, if desired.
- ⑧ Push [EXIT/SET] to exit memory list screen.

Memory clearing

Any unused memory channels can be cleared. The cleared memory channels become blank channels.

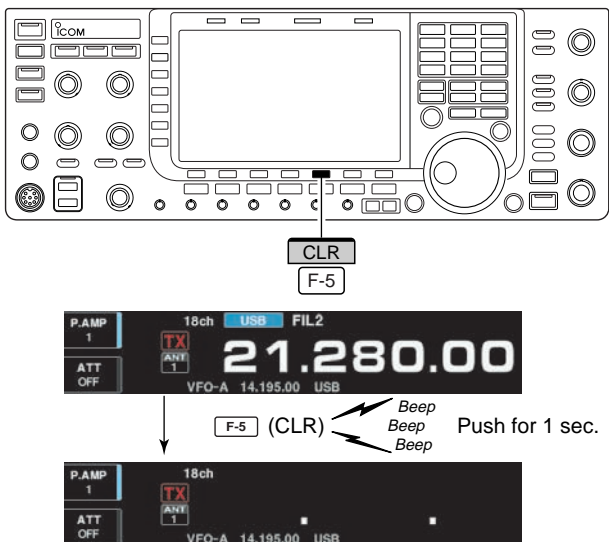

- ① Select memory mode with [V/M].
- ② Push [F-4•MEMORY] to select memory list screen.
- ③ Select the desired memory channel with [▲] / [▼].
- ④ Push and hold [F-5•CLR] for 1 sec. to clear the contents.
 - The programmed frequency and operating mode disappear.
- ⑤ To clear other memory channels, repeat steps ③ and ④.

■ Memo pads

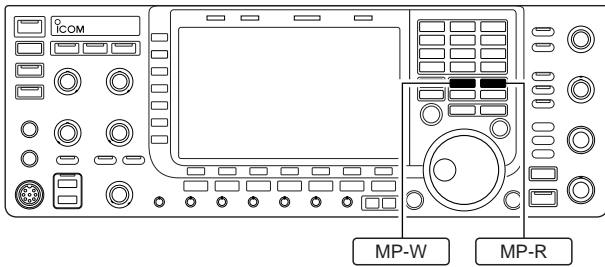

The transceiver has a memo pad function to store frequency and operating mode for easy write and recall. The memo pads are separate from memory channels.

The default number of memo pads is 5, however, this can be increased to 10 in set mode if desired. (p. 12-15)

Memo pads are convenient when you want to memorize a frequency and operating mode temporarily, such as when you find a DX station in a pile-up, or when a desired station is busy for a long time and you want to temporarily search for other stations.

Use the transceiver's memo pads instead of relying on hastily scribbled notes that are easily misplaced.

◇ Writing frequencies and operating modes into memo pads

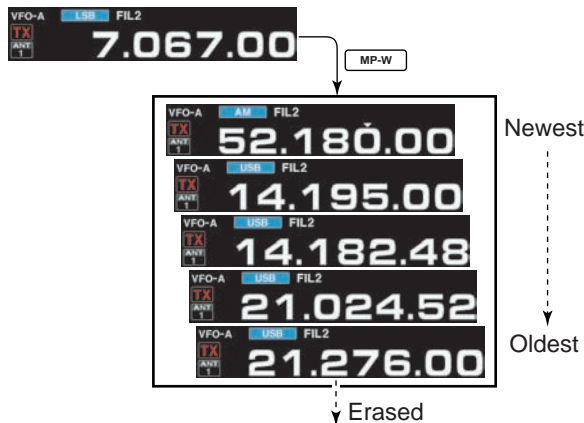

In this example, 21.276 MHz (USB) will be erased when 7.067 MHz (LSB) is written.

You can store the readout frequency and operating mode by pushing **[MP-W]**.

When you store a 6th frequency and operating mode, the oldest stored frequency and operating mode are automatically erased to make room for the new settings.

Each memo pad must have its own unique combination of frequency and operating mode; memo pads having identical settings cannot be written.

◇ Calling up a frequency from a memo pad

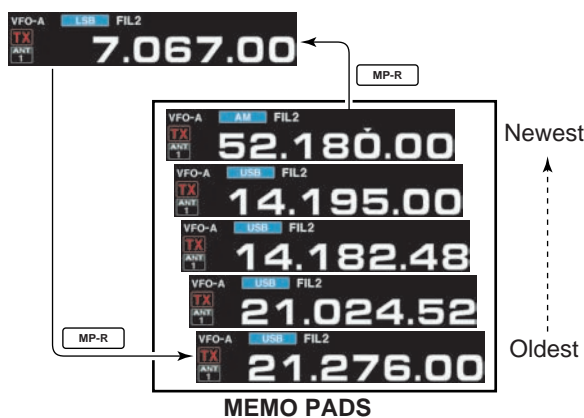

You can call up the desired frequency and operating mode of a memo pad by pushing **[MP-R]** several times.

- Both VFO and memory modes can be used.
- The frequency and operating mode are called up, starting from the most recently written.

When you call up a frequency and an operating mode from memo pads with **[MP-R]**, the previously displayed frequency and operating mode are automatically stored in a temporary pad. The frequency and operating mode in the temporary pad can be recalled by pushing **[MP-R]** several times.

- You may think there are 6 memo pads because 6 different frequencies (5 are in memo pads and 1 is in the temporary pad) are called up by **[MP-R]**.

If you change the frequency or operating mode called up from a memo pad with the main dial, etc., the frequency and operating mode in the temporary pad are erased.

■ Scan types	9-2
■ Preparation	9-2
■ Voice squelch control function	9-3
■ Scan set mode	9-3
■ Programmed scan operation	9-4
■ ΔF scan operation	9-4
■ Fine programmed scan/Fine ΔF scan	9-5
■ Memory scan operation	9-6
■ Select memory scan operation	9-6
■ Setting select memory channels	9-7
◇ Setting in scan screen	9-7
◇ Setting in memory list screen	9-7
◇ Erasing the select scan setting	9-7
■ Tone scan	9-8

Scan types

- The scan function can be used on the main read-out only.
- You can operate a scan while operating on a frequency using the split functions.

PROGRAMMED SCAN

Repeatedly scans between two scan edge frequencies (scan edge memory channels P1 and P2).

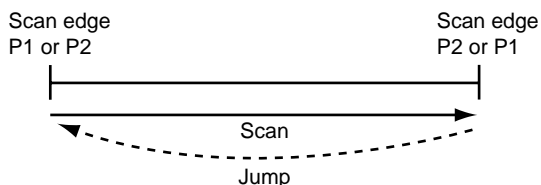

This scan operates in VFO mode.

ΔF SCAN

Repeatedly scans within ΔF span area.

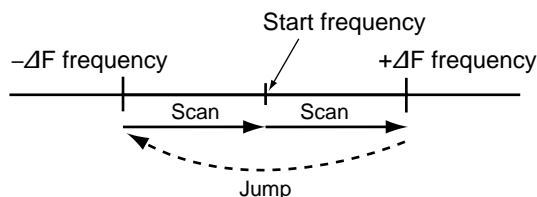

This scan operates in both VFO and memory modes.

MEMORY SCAN

Repeatedly scans all programmed memory channels.

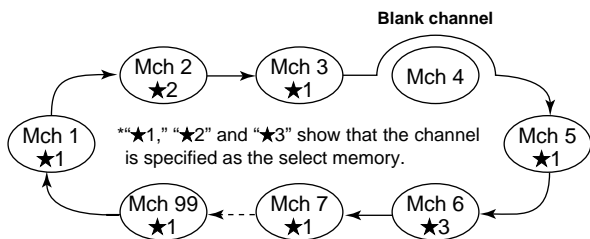

This scan operates in memory mode.

SELECT MEMORY SCAN

Repeatedly scans all or one of 3 select memory channels.

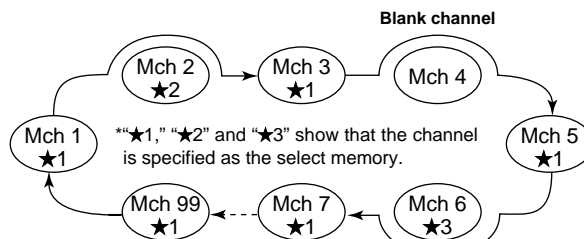

This scan operates in memory mode.

Preparation

Channels

For programmed scan:

Program scan edge frequencies into scan edge memory channels P1 and P2.

For ΔF scan:

Set the ΔF span (ΔF scan range) in the scan screen.

For memory scan:

Program 2 or more memory channels except scan edge memory channels.

For select memory scan:

Designate 2 or more memory channels as select memory channels. To designate the channel as a select memory channel, choose a memory channel, then push [F-3•SELECT] in the scan screen (memory mode) or in the memory list screen.

Scan resume ON/OFF

You can select the scan to resume or cancel when detecting a signal in set mode. Scan resume ON/OFF must be set before operating a scan. See p. 9-3 for ON/OFF setting and scan resume condition details.

Scan speed

Scan speed can be selected from 2 levels, high or low, in scan set mode. See p. 9-3 for details.

Squelch condition

SCAN STARTS WITH	PROGRAMMED SCAN	MEMORY SCAN
SQUELCH OPEN	The scan continues until it is stopped manually, and does not pause even if it detects signals.	Scan pauses on each channel when the scan resume is ON; not applicable when OFF.
SQUELCH CLOSED	Scan stops when detecting a signal. If you set scan resume ON in set mode, the scan pauses for 10 sec. when detecting a signal, then resumes. When a signal disappears while scan is paused, scan resumes 2 sec. later.	

■ Voice squelch control function

This function is useful when you don't want unmodulated signals pausing or cancelling a scan. When the voice squelch control function is activated, the transceiver checks received signals for voice components.

If a received signal includes voice components, and the tone of the voice components changes within 1 sec., scan pauses (or stops). If the received signal includes no voice components or the tone of the voice components does not change within 1 sec., scan resumes.

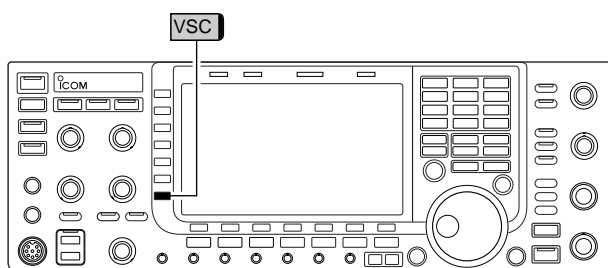

- While a phone mode (SSB, AM or FM) is selected, push [VSC] (MF7) to switch the VSC (Voice Squelch Control) function ON and OFF.
 - "VSC" appears when the function is activated.

- ▨ • The VSC function activates for any scan.
- ▨ • The VSC function resumes the scan on unmodulated signals, regardless of whether the scan resume condition is set to ON or OFF.

■ Scan set mode

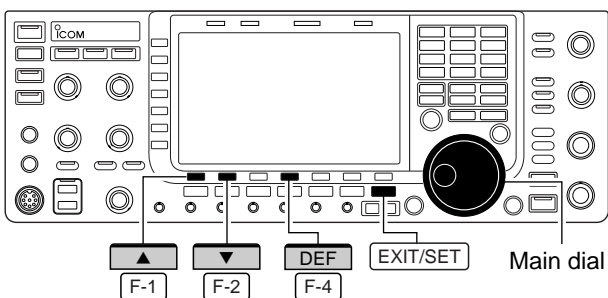

When the squelch is open, scan continues until it is stopped manually—it does not pause on detected signals. When squelch is closed, scan stops when detecting a signal, then resumes according to the scan resume condition. Scan speed and the scan resume condition can be set using the scan set mode.



- ① Push [F-5•SCAN] to select scan screen.
- ② Push [F-7•SET] to select scan set mode.
- ③ Push [F-1•▲] or [F-2•▼] to select the desired item.
- ④ Rotate the main dial to select the desired condition.
 - Push and hold [F-4•DEF] for 1 sec. to select the default setting.
- ⑤ Push [EXIT/SET] to return to scan menu.

Scan Speed	HIGH
Select the desired scan speed from high and low.	<ul style="list-style-type: none"> • HIGH : scan is faster • LOW : scan is slower

Scan Resume	ON
Set the scan resume function ON and OFF.	<ul style="list-style-type: none"> • ON : When detecting a signal, scan pauses for 10 sec., then resumes. When a signal disappears, scan resumes 2 sec. later. • OFF : When detecting a signal, cancels scanning.

■ Programmed scan operation

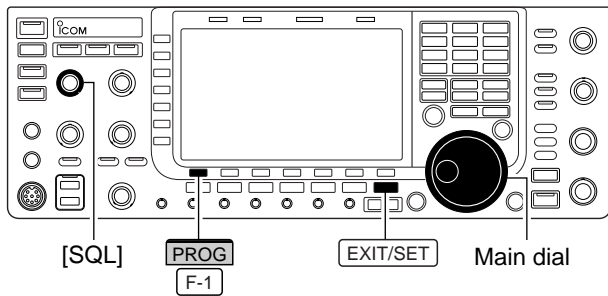

- ① Push [EXIT/SET] several times to close a multi-function screen, if necessary.
- ② Select VFO mode.
- ③ Select the desired operating mode.
 - The operating mode can also be changed while scanning.
- ④ Push [F-5•SCAN] to select the scan screen.
- ⑤ Set [SQL] open or closed.
 - See page 9-2 for squelch condition.
- ⑥ Push [F-1•PROG] to start the programmed scan.
 - “PROGRAM SCAN” and decimal points blink while scanning.
- ⑦ When the scan detects a signal, scan stops, pauses or ignores it depending on the resume setting and the squelch condition.
- ⑧ To cancel the scan, push [F-1•PROG].
 - Rotating the main dial also cancels the scan.
- ⑨ Push and hold [F-6•RECALL] for 1 sec. to recall the frequency that is set before starting the scan, if desired.

⚡ If the same frequencies are programmed into the scan edge memory channel P1 and P2, programmed scan will not start.

■ ΔF scan operation

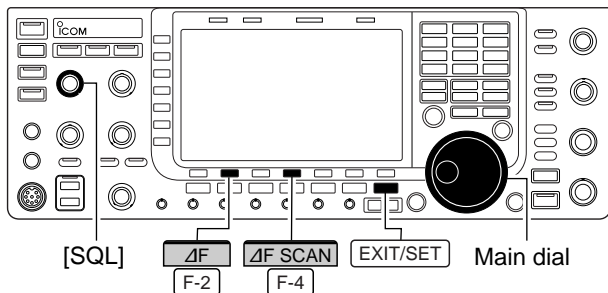

- ① Push [EXIT/SET] several times to close a multi-function screen, if necessary.
- ② Select VFO mode or a memory channel.
- ③ Select the desired operating mode.
 - The operating mode can also be changed while scanning.
- ④ Push [F-5•SCAN] to select the scan screen.
- ⑤ Set the main band's [SQL] open or closed.
 - See page 9-2 for squelch condition.
- ⑥ Set the ΔF span by pushing [F-4• ΔF SPAN].
 - ± 5 kHz, ± 10 kHz, ± 20 kHz, ± 50 kHz, ± 100 kHz, ± 500 kHz and ± 1000 kHz are selectable.
- ⑦ Set center frequency of the ΔF span.
- ⑧ Push [F-2• ΔF] to start the ΔF scan.
 - “ ΔF SCAN” and decimal points blink while scanning.
- ⑨ When the scan detects a signal, the scan stops, pauses or ignores it depending on the resume setting and the squelch condition.
- ⑩ To cancel the scan, push [F-2• ΔF].
 - Rotating the main dial also cancels the scan.
- ⑪ Push and hold [F-6•RECALL] for 1 sec. to recall the frequency that was set before starting the scan.

■ Fine programmed scan/Fine ΔF scan

In fine scan (programmed or ΔF), the scan speed decreases when the squelch opens, but the transceiver keeps scanning. The scanning tuning step shifts from 50 Hz to 10 Hz when the squelch opens.

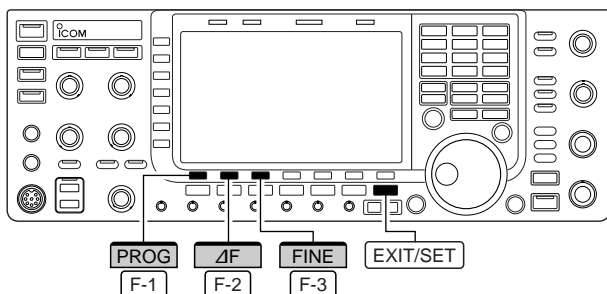

- ① Push [EXIT/SET] several times to close a multi-function screen, if necessary.
- ② Push [F-5•SCAN] to select the scan screen.
- ③ Set for programmed scan or ΔF scan as described on previous page.
- ④ Push [F-1•PROG] or [F-2• ΔF] to start a scan.
 - “PROGRAM SCAN” or “ ΔF SCAN” and decimal points blink while scanning.
- ⑤ Push [F-3•FINE] to start a fine scan.
 - “FINE PROGRAM SCAN” or “FINE ΔF SCAN” blinks instead of “PROGRAM SCAN” or “ ΔF SCAN,” respectively.
- ⑥ When the scan detects a signal, the scan speed decreases but scan does not stop.
- ⑦ Push [F-1•PROG] or [F-2• ΔF] to stop the scan; push [F-3•FINE] to cancel the fine scan.
 - Rotating the main dial also cancels the scan.
- ⑧ Push and hold [F-6•RECALL] for 1 sec. to recall the frequency that is set before starting the scan, if desired.

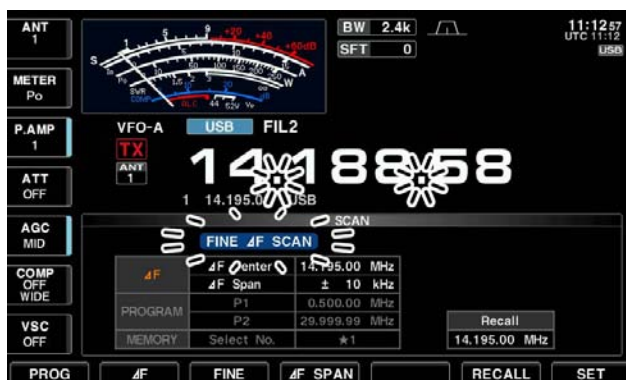

Memory scan operation

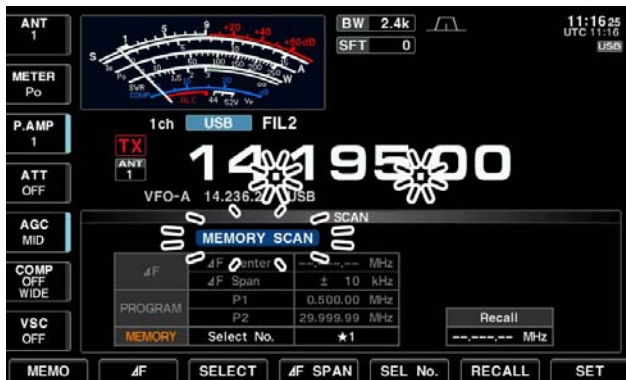
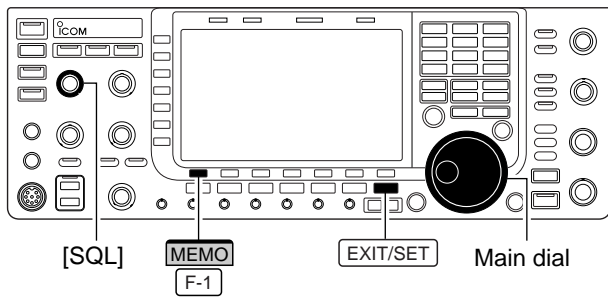

- ① Push [EXIT/SET] several times to close a multi-function screen, if necessary.
- ② Select memory mode.
- ③ Push [F-5•SCAN] to select the scan screen.
- ④ Set [SQL] open or closed.
 - See page 9-2 for squelch condition.
- ⑤ Push [F-1•MEMO] to start the memory scan.
 - “MEMORY SCAN” and decimal points blink while scanning.
- ⑥ When the scan detects a signal, the scan stops, pauses or ignores it depending on the resume setting and the squelch condition.
- ⑦ To cancel the scan, push [F-1•MEMO].
 - Rotating the main dial also cancels the scan.

2 or more memory channels must be programmed for memory scan to start.

Select memory scan operation

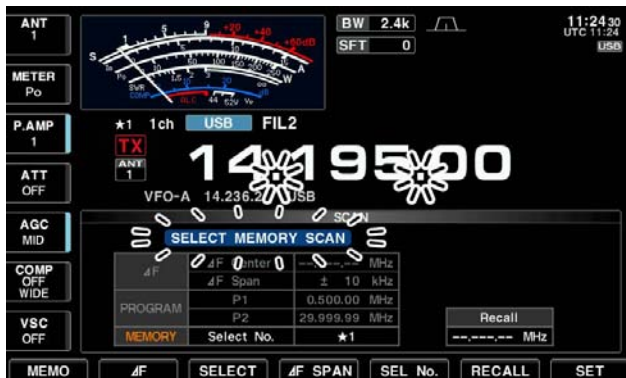
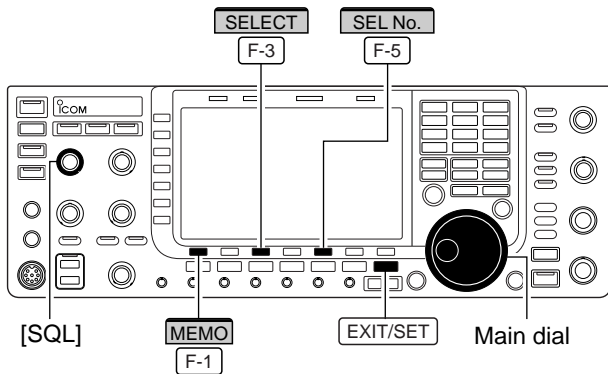

- ① Push [EXIT/SET] several times to close a multi-function screen, if necessary.
- ② Select memory mode.
- ③ Push [F-5•SCAN] to select the scan screen.
- ④ Set [SQL] open or closed.
 - See page 9-2 for squelch condition.
- ⑤ Push [F-5•SEL No.] several times to select the select scan number from ★1, ★2, ★3 and ★1/★2/★3.
- ⑥ Push [F-1•MEMO] to start the memory scan.
 - “MEMORY SCAN” and decimal points blink while scanning.
- ⑦ Push [F-3•SELECT] to start select memory scan; push [F-3•SELECT] again to return to memory scan, if desired.
 - “SELECT MEMORY SCAN” blinks instead of “MEMORY SCAN” during select memory scan.
- ⑧ When the scan detects a signal, the scan stops, pauses or ignores it depending on the resume setting and the squelch condition.
- ⑨ To cancel the scan, push [F-1•MEMO].
 - Rotating the main dial also cancels the scan.

2 or more memory channels must be designated as select memory channels, as well as the same select scan channel number, for select memory scan to start.

■ Setting select memory channels

◇ Setting in scan screen

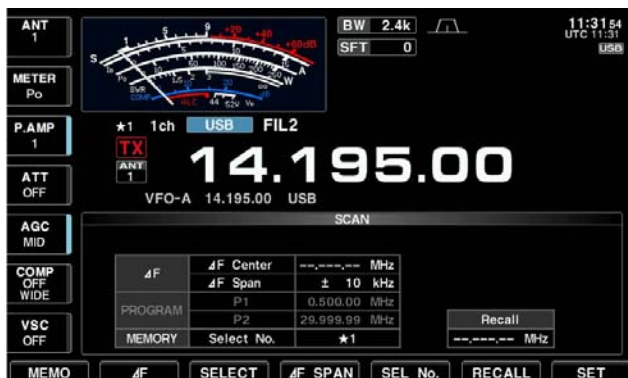

- ① Push [EXIT/SET] several times to close a multi-function screen, if necessary.
- ② Select memory mode.
- ③ Push [F-5•SCAN] to select the scan screen.
- ④ Select the desired memory channel to set as a select memory channel.
 - [▲] / [▼] keys and direct keypad selections can be used.
- ⑤ Push [F-3•SELECT] several times to set the memory channel as a select memory ★1, ★2, ★3 or not.
- ⑥ Repeat steps ④ to ⑤ to program another memory channel as a select memory channel.
- ⑦ Push [EXIT/SET] to exit the scan screen.

◇ Setting in memory list screen



- ① Push [EXIT/SET] several times to close a multi-function screen, if necessary.
- ② Push [F-4•MEMORY] to select memory list screen.
- ③ Rotate the main dial while pushing [F-1•ROLL] or [F-2•SET] to select the desired memory channel.
 - [▲] / [▼] keys and direct keypad selections can be used.
- ④ Push [F-3•SELECT] several times to set the memory channel as a select memory ★1, ★2, ★3 or not.
- ⑤ Repeat steps ③ to ④ to program another memory channel as a select memory channel.
- ⑥ Push [EXIT/SET] to exit the memory list screen.

◇ Erasing the select scan setting



- ① Push [EXIT/SET] several times to close a multi-function screen, if necessary.
- ② Push [F-4•MEMORY] to select memory list screen, or push [F-5•SCAN] to select scan screen.
- ③ Push and hold [F-3•SELECT] for 1 sec. to display memory select all clear window.
- ④ Push one of the following keys to clear all select scan setting.
 - [F-1•★1] : Clears all ★1 setting.
 - [F-2•★2] : Clears all ★2 setting.
 - [F-3•★3] : Clears all ★3 setting.
 - [F-4•★1,2,3] : Clears all select setting.
- ⑤ Push [EXIT/SET] to exit the memory list screen.

■ Tone scan

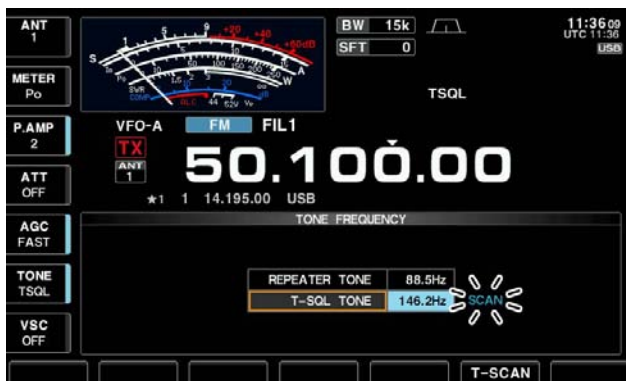
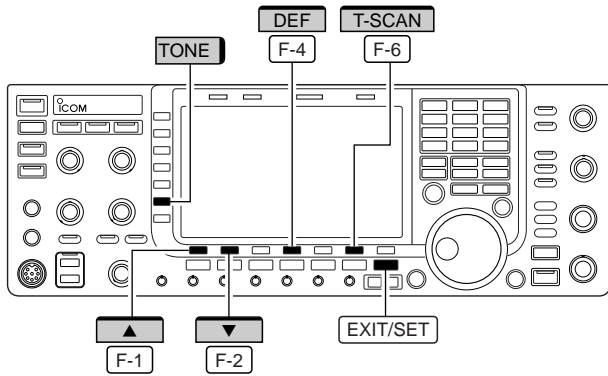

The transceiver can detect subaudible tones in a received signal. By monitoring a signal that is being transmitted on a repeater input frequency, you can determine the tone frequency required to access the repeater.

- ① Set the desired frequency or memory channel to be checked for a tone frequency.
- ② Push **[AM/FM]** several times to select FM mode.
- ③ Push and hold **[TONE]** (MF6) for 1 sec. to enter tone frequency screen.
- ④ Push **[F-1•▲]** or **[F-2•▼]** to check the repeater tone frequency or tone squelch frequency, respectively.
- ⑤ Push **[F-6•T-SCAN]** to start the tone scan.
 - "SCAN" blinks while scanning.
- ⑥ When the tone frequency is detected, the tone scan pauses.
 - The tone frequency is set temporarily on a memory channel. Program the memory channel to store the tone frequency permanently.
 - The decoded tone frequency is used for the repeater tone frequency or tone squelch frequency.
- ⑦ To stop the scan, push **[F-6•T-SCAN]**.
 - Push and hold **[F-4•DEF]** for 1 sec. to select the default frequency.
- ⑧ Push **[EXIT/SET]** to exit tone frequency screen.

■ Antenna connection and selection	10-2
■ Antenna memory settings	10-3
◇ Antenna type selection	10-3
◇ Temporary memory	10-4
◇ Antenna selection mode	10-4
◇ Receive antenna I/O setting	10-5
■ Antenna tuner operation	10-6
◇ Tuner operation	10-6
◇ If the tuner cannot tune the antenna	10-7

■ Antenna connection and selection

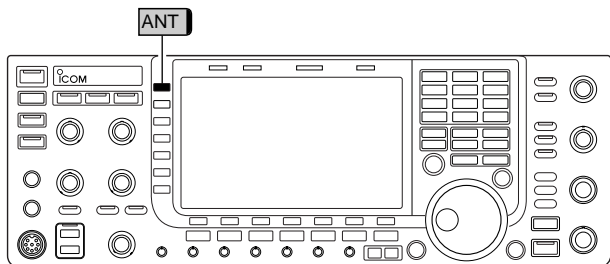

The IC-7700 has 4 antenna connectors for the HF/50 MHz bands, [ANT1], [ANT2], [ANT3], and [ANT4].

For each operating band the IC-7700 covers, there is a band memory which can memorize the selected antenna. When you change the operating frequency outside of a band, the previously used antenna is automatically selected (see below) for the new band. This function allows automatic switching of 4 separate antennas for HF and 50 MHz bands operation.

• Antenna selection mode: “Auto”

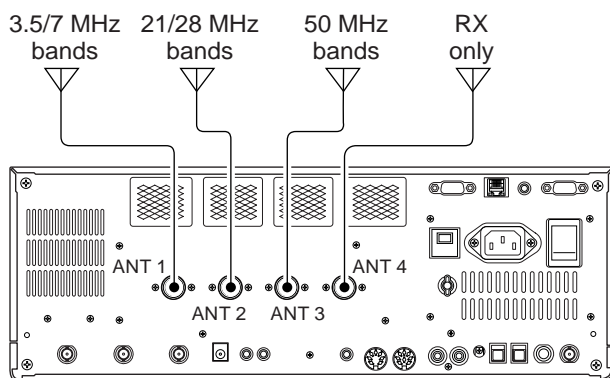

After an antenna has been selected for use (by pushing [ANT] (MF1)), the antenna is automatically selected whenever that band is used.

[EXAMPLE]: a 3.5/7 MHz antenna is connected to [ANT1], a 21/28 MHz antenna is connected to [ANT2], a 50 MHz antenna is connected to [ANT3]. When the antenna selector function is set to “Auto,” an antenna is automatically selected when changing bands. A receive-only antenna can be specified for [ANT4].

• Antenna selection mode: “Manual”

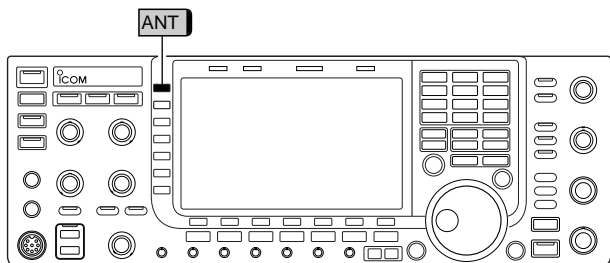

When “Manual” is selected, you can use the all antenna connectors, [ANT1] [ANT2], [ANT3] and [ANT4], however, band memory does not function. In this case you must select an antenna manually.

• Antenna selection mode: “OFF”

In this case, only [ANT1] antenna connector can be used. [ANT] (MF1) switch does not function.

■ Antenna memory settings

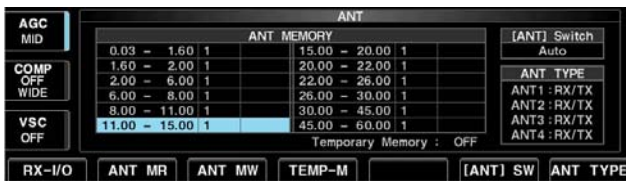
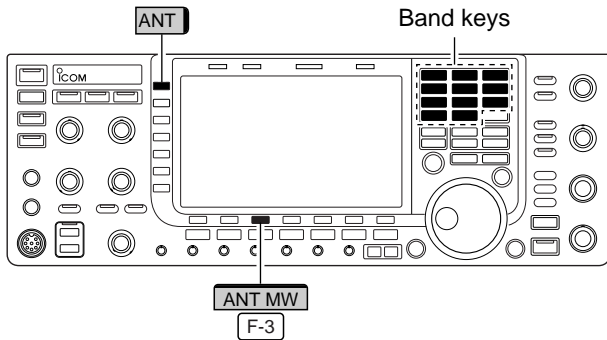

This function stores the antenna connector number for each frequency band.

- ① Push [EXIT/SET] several times to close multi-function screen, if necessary.
- ② Push and hold [ANT] (MF1) for 1 sec. to select antenna set screen.
- ③ Select the desired frequency band with a band key.
- ④ Push [ANT] (MF1) several times to select the desired antenna number that you want to set for the selected frequency band.
 - “★” appears.
- ⑤ Push and hold [F-3•ANT MW] for 1 sec. to store the antenna selection into the antenna memory.
 - “★” disappears.
- ⑥ Repeat the steps ③ to ⑤ to store the antenna selection for another frequency bands, if desired.
- ⑦ Push [EXIT/SET] to exit antenna set screen.

◇ Antenna type selection

When no antenna is connected to [ANT2], [ANT3], and/or [ANT4], these antenna connectors can be deactivated — deleting the antenna number from the available selections. This prevents the transceiver from accidentally transmitting into an unused antenna connector. In addition, a receive-only antenna can be specified for [ANT4].

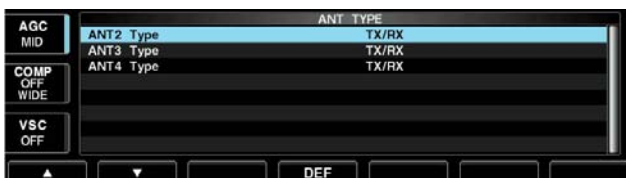
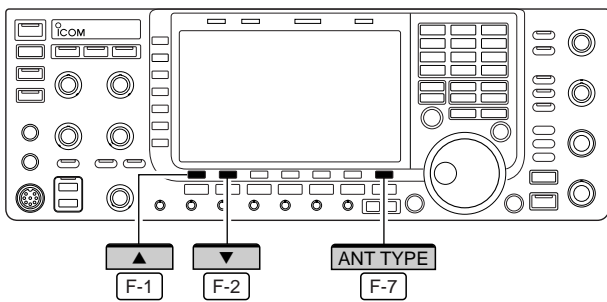

- ① Select the antenna set screen as described above.
- ② Push [F-7•ANT TYPE] to select antenna type set screen.
- ③ Push [F-1•▲] or [F-2•▼] to select the desired antenna.
- ④ Rotate the main dial to select the desired antenna condition from TX/RX, RX (ANT4 only) and OFF.
 - TX/RX : Select when an antenna is connected.
 - OFF : Select when no antenna is connected.
 - RX : Select when a receive only antenna is connected. (available for the [ANT4] only)
- ⑤ Push [EXIT/SET] to exit antenna type set screen.

✓ For your information

The “OFF” antennas cannot be selected with [ANT] (MF1) switch operation, or with the antenna memory setting.

When “RX” is selected for [ANT4], “1/R,” “2/R” and “3/R” selections will be added for the selection for both [ANT] (MF1) switch operation and the antenna memory setting. In these selections, the antenna connected to [ANT1], [ANT2] and/or [ANT3] will be used for transmission and the antenna connected to [ANT4] will be used for reception.

■ Antenna memory settings (continued)

◇ Temporary memory

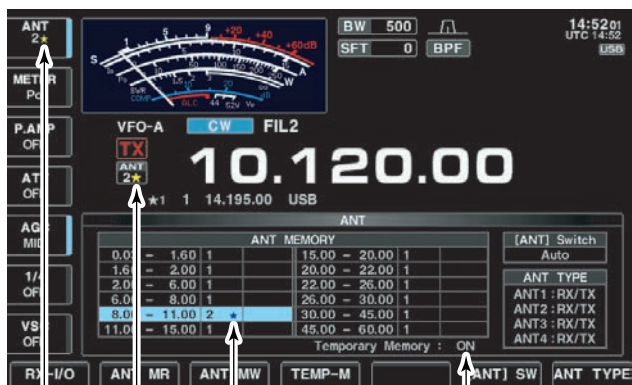

“★” indicators appear when a different antenna from the original is selected.

Push [F-4•TEMP-M] to turn the temporary memory ON and OFF.

The antenna temporary memory memorizes the manually selected antenna. The selected antenna will be re-called even if frequency band has been changed.

- ① Select the antenna set screen.
- ② Push [F-4•TEMP-M] to turn the temporary memory ON and OFF.
- ③ Select the desired frequency band with a band key.
- ④ Push [ANT] (MF1) to select the desired antenna.
 - “★” appears when a different antenna from the original is selected.
- ⑤ Push [F-1•ANT MR] to re-call the original antenna.
 - “★” disappears.
- ⑥ Push [EXIT/SET] to exit antenna set screen.

CAUTION! Before transmitting with the manually selected antenna, make sure the selected antenna suits the operating frequency. Otherwise the transceiver may be damaged.

◇ Antenna selection mode

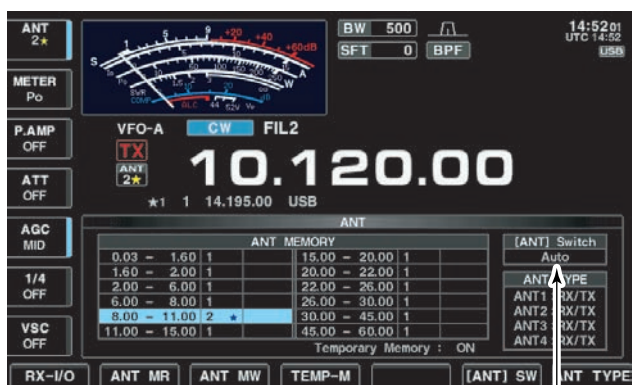

Push [ANT SW] [F-6] to select the antenna selection mode.

The automatic antenna selection (antenna memory) and the [ANT] (MF1) switch function can be deactivated if desired.

- ① Select the antenna set screen.
- ② Push [F-6•[ANT] SW] to select the antenna selection from Auto, OFF and Manual.
 - Auto : Use the antenna memory. Antenna selection with [ANT] switch is also available.
 - OFF : Only the antenna connected to [ANT1] can be used. [ANT] switch is deactivated.
 - Manual: Deactivate the antenna memory function. Antenna can be selected with [ANT] switch operation only.
- ③ Push [EXIT/SET] to exit antenna set screen.

◇ Receive antenna I/O setting

In default setting, receive antenna connectors, [RX ANT-IN] and [RX ANT-OUT], on the rear panel are deactivated and are connected internally by the switching relay. If you want to connect an external preamp or low-pass filter between the [RX ANT-IN] and [RX ANT-OUT], you must activate them as described below.

- ① Select the antenna set screen.
- ② Select the desired frequency band with a band key.
- ③ Push [F-1•RX-I/O] to activate the receive antenna connectors ([RX ANT-IN] and [RX ANT-OUT]).
 - “RX-I/O” indicators appear when [RX ANT-IN] and [RX ANT-OUT] are active.
- ④ Repeat steps ② and ③, if desired.
- ⑤ Push [EXIT/SET] to exit antenna set screen.

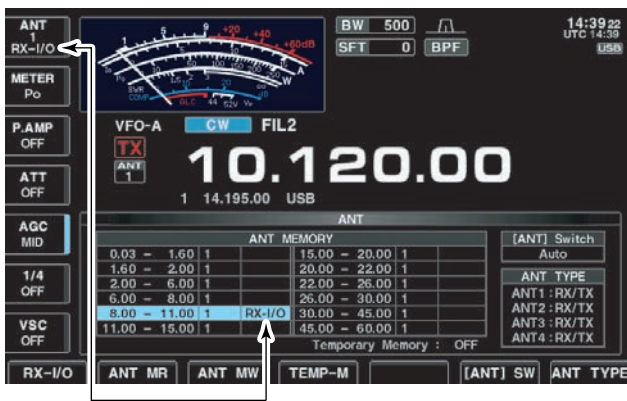
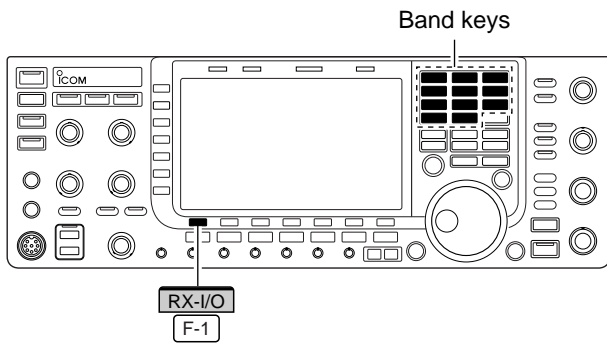

“RX-I/O” indicators appear when [RX ANT-IN] and [RX ANT-OUT] are active.

■ Antenna tuner operation

◇ Tuner operation

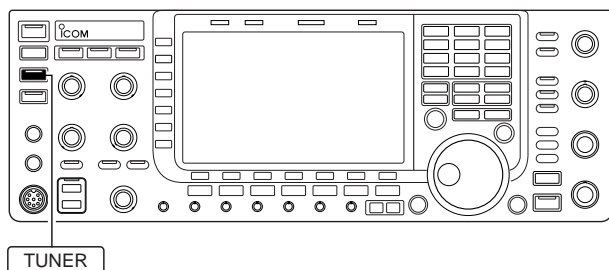

The internal automatic antenna tuner matches the transceiver to the connected antenna automatically. After the tuner matches an antenna, the variable capacitor settings are memorized as a preset point for each frequency range (100 kHz steps). Therefore, when you change the frequency range, the variable capacitors are automatically preset to the memorized setting.

CAUTION: NEVER transmit with the tuner ON when no antenna is connected. This will damage the transceiver. Be careful of the antenna selection.

- ➔ Push **TUNER** to turn the internal antenna tuner ON. The antenna is tuned automatically when the antenna SWR is higher than 1.5:1.
 - When the tuner is ON, **TUNER** switch indicator lights green.
 - While tuning, **TUNER** switch indicator blinks green.

NOTES:

- NEVER transmit without an antenna properly connected to antenna port in use.
- When 2 or more antennas are connected, select the antenna to be used with **ANT**.
- If the SWR is higher than about 1.5:1 when tuning above 100 kHz on an antenna's preset point, push and hold **TUNER** for 1 sec. to start manual tuning.
- The internal tuner may not be able to tune in AM mode. In such cases, push and hold **TUNER** for 1 sec. to manually tune.

• MANUAL TUNING

During SSB operation at low voice levels, the internal tuner may not be tuned correctly. In such cases, manual tuning is helpful.

- ➔ Push and hold **TUNER** for 1 sec., to start manual tuning.
 - A side tone is emitted and **TUNER** switch indicator blinks red while tuning.
 - If the tuner cannot reduce the SWR to less than 1.5:1 after 20 sec. of tuning, the **TUNER** switch indicator goes out.

• AUTOMATIC TUNER START (HF bands only)

If you want to deactivate the tuner under conditions of VSWR 1.5:1 or less, use the auto tuner start function and turn the tuner OFF. This function activates the tuner automatically when the SWR exceeds 1.5:1.

This function is turned ON in set mode. (p. 12-13).

■ Antenna tuner operation (continued)

• PTT TUNER START

The tuner is always tuned when the PTT is pushed after the frequency is changed (more than 1% from last-tuned frequency). This function removes the “push and hold [TUNER]” operation and activates for the first transmission on a new frequency.

This function is turned ON in set mode. (p. 12-13).

• Antenna tuner of the IC-PW1

When using an external antenna tuner such as the IC-PW1's tuner, tune with the external antenna tuner, and turn OFF the IC-7700's tuner. After tuning is completed, turn the internal tuner ON. Otherwise, both tuners tune simultaneously and correct tuning may not be obtained.

See the instruction manual included with each antenna tuner for their respective operations.

◇ If the tuner cannot tune the antenna

Check the following and try again:

- the [ANT] connector selection.
- the antenna connection and feedline.
- the untuned antenna SWR. (Less than 3:1 for HF bands; Less than 2.5:1 for 50 MHz band)
- the transmit power. (8 W for HF bands; 15 W for 50 MHz band)
- the power source voltage/capacity.

If the tuner cannot reduce the SWR to less than 1.5:1 after checking the above, perform the following:

- repeat manual tuning several times.
- tune with a 50 Ω dummy load and re-tune the antenna.
- turn power OFF and ON.
- adjust the antenna feedline length.
(This is effective for higher frequencies in some cases.)
- Some antennas, especially for low bands, have a narrow bandwidth. These antennas may not be tuned at the edge of their bandwidth, therefore, tune such an antenna as follows:

[Example]: Suppose you have an antenna which has an SWR of 1.5:1 at 3.55 MHz and an SWR of 3:1 at 3.8 MHz.

- ① Push [TUNER] to turn the antenna tuner ON.
- ② Select CW mode.
- ③ Turn OFF the break-in function. (p. 6-3)
- ④ Push [TRANSMIT] to set to the transmit condition.
- ⑤ Set 3.55 MHz and key down.
- ⑥ Set 3.80 MHz and key down.
- ⑦ Push [TRANSMIT] to return to the receive condition.

■ Time set mode	11-2
■ Daily timer setting	11-3
■ Setting sleep timer	11-4
■ Timer operation	11-4

Time set mode

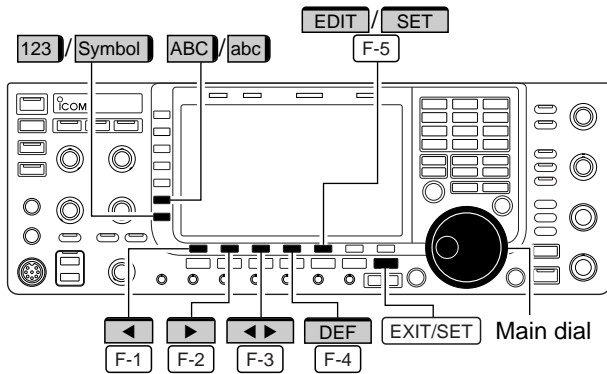

The IC-7700 has a built-in calendar and 24-hour clock (accuracy ± 75 sec. per month) with daily power ON/OFF timer functions. Before operating these timer functions, set the current date and time.

- ① Push **EXIT/SET** to close multi-function screen, if necessary.
- ② Push **[F-7•SET]** to select set mode menu screen.
- ③ Push **[F-4•TIME]** to select time set mode.
- ④ Push **[F-1•▲]** or **[F-2•▼]** to select the desired item.
- ⑤ Rotate the main dial to set or select the desired value or condition.
- ⑥ Push **EXIT/SET** to exit time set mode.

Date

2000 - 1 - 1 (Sat)

Sets the date.

- ① Push **[F-3•◀▶]** to select between the year and the month/day, then rotate the main dial to select them.
 - The date setting and "DATE-set Push [SET]" indication blink.
- ② Push **[F-5•SET]** to set the date.

Time (Now)

1:23

Sets the local time.

- ① Rotate the main dial to set the local time.
 - The time setting and "TIME-set Push [SET]" indication blink.
- ② Push **[F-5•SET]** to set the time.

CLOCK2 Function

ON

Turns the CLOCK2 indicator ON and OFF. CLOCK2 is convenient to indicate UTC or other country's local time, etc.

- **ON** : The CLOCK2 indicator is displayed below the local time indication.
- **OFF** : The CLOCK2 indicator does not display.

CLOCK2 Offset

± 0:00

Sets the desired off-set time period for CLOCK2 display within -24:00 to +24:00 in 5 min. steps.

- Push and hold **[F-4•DEF]** for 1 sec. to select the default value.

CLOCK2 Name

UTC

Sets the desired 3-character name for CLOCK2.

Capital letters, small letters, numerals, some symbols (! # \$ % & ¥ ? " ' ` ^ + - * / . , ; = < > () [] { } | _ ~ @) and spaces can be used.

- ① Push **[F-5•EDIT]** to select the name edit condition.
 - The cursor under the 1st character blinks.
- ② Push **[ABC]**, **[abc]**, **[123]** or **[Symbol]** to select the character group, then rotate the main dial to select the character.
 - Push **[ABC]** or **[abc]** to toggle capital and small letters.
 - Push **[123]** or **[Symbol]** to toggle numerals and symbols.
 - Push **[F-1•◀]** or **[F-2•▶]** for cursor movement.
 - Push **[F-3•DEL]** to delete the selected character.
 - Push **[F-4•SPACE]** to input a space.
 - Pushing the transceiver's keypad, **[0]–[9]**, can also enter numerals.
- ③ Push **EXIT/SET** to set the name.

Daily timer setting

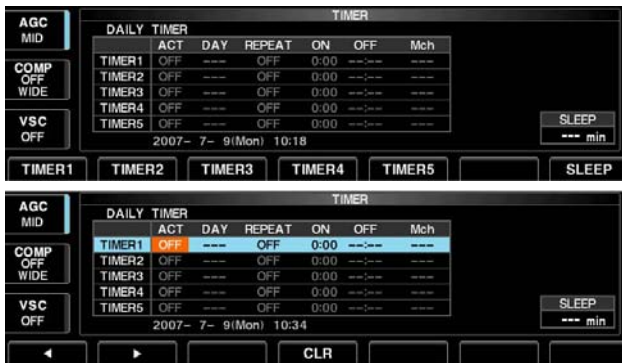
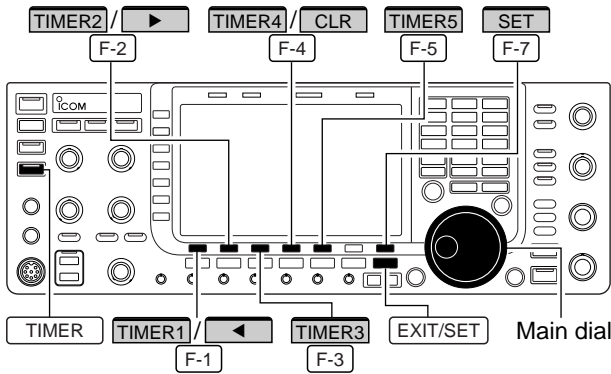

The transceiver turns power ON and/or OFF automatically on the specified day and time, with the specified frequency settings.

- ① Push [EXIT/SET] several times to close multi-function screen, if necessary.
- ② Push and hold [TIMER] for 1 sec. to select timer set screen.
- ③ Push one of [F-1•TIMER1] to [F-5•TIMER5] to select the desired timer.
- ④ Rotate the main dial to select the timer action ON and OFF.
- ⑤ Push [F-2•▶] to select the “DAY” cell, then rotate the main dial to select the desired day of the week.
 - Select “- - -” not to specify the day of the week. The timer will function every day in this case.
 - Once a day of the week is selected, push [F-4•CLR] to select “- - -”.
- ⑥ Push [F-2•▶] to select the “REPEAT” cell, then rotate the main dial to select the repeat function ON and OFF.
 - ON : The timer functions every selected day of the week. (repeats)
 - OFF : The timer does not repeat.
- ⑦ Push [F-2•▶] to select the “ON” cell, then rotate the main dial to set the desired transceiver power ON time.
 - When using power OFF timer only, push [F-4•CLR] to select “- - -.” This setting cannot be set when the power OFF timer is set to “- - -.”
- ⑧ Push [F-2•▶] to select the “OFF” cell, then rotate the main dial to set the desired transceiver power OFF time.
 - When using power ON timer only, push [F-4•CLR] to select “- - -.” This setting cannot be set when the power ON timer is set to “- - -.”
- ⑨ Push [F-2•▶] to select the “Mch” cell, then rotate the main dial to select the desired memory channel number.
 - If using the currently set VFO condition, push [F-4•CLR] to select “- - -.”
- ⑩ Push [F-7•SET] to set the timer.
 - The timer indicator above [TIMER] switch lights green.
- ⑪ Repeat steps ③ to ⑩ to set other timers, if desired.
- ⑫ Push [EXIT/SET] to exit timer set screen.

■ Setting sleep timer

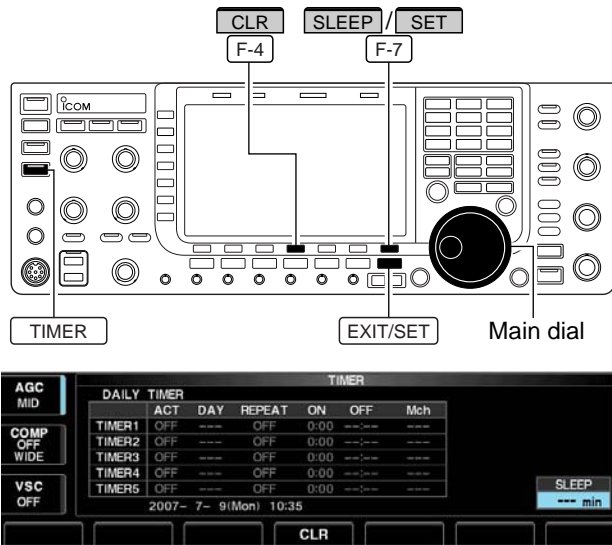

The sleep timer turns the transceiver power OFF automatically after passing the set period. The timer can be set to 5–120 min. in 5 min. steps.

▨ The sleep timer function counts the 'minute' units, and does not count the 'second' units. For example, when the sleep timer is started at 12:00 59, first one minute past for just 1 sec. That is way it has a max. 59 sec. error. This is normal, not a malfunction.

- ① Push [EXIT/SET] several times to close a multi-function screen, if necessary.
- ② Push and hold [TIMER] for 1 sec. to select timer set screen.
- ③ Push [F-7•SLEEP] to select the sleep timer set condition.
 - "---" blinks.
- ④ Set the desired time period using the main dial.
 - "TIMER-set Push [SET]" blinks.
 - Push [F-4•CLR] to select "---" to cancel the setting.
- ⑤ Push [F-7•SET] to set the time.
 - Push [EXIT/SET] to cancel the setting.
 - The timer indicator above [TIMER] switch lights green.
- ⑥ Push [EXIT/SET] to exit timer set screen.
- ⑦ The transceiver emits 10 beeps and turns OFF after the sleep timer period elapses.
 - The timer indicator blinks while beeping.
 - Push [TIMER] momentarily to cancel the sleep timer, if desired.

■ Timer operation

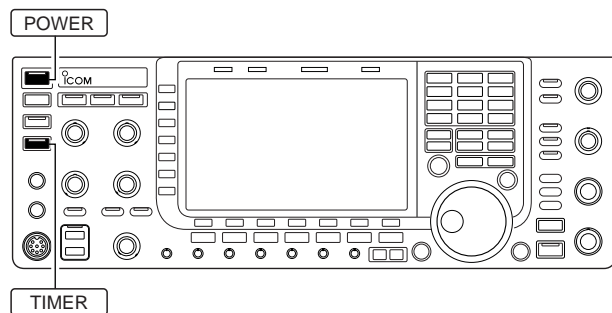

- ① Preset the daily timer as described previously.
- ② Push [TIMER] momentarily to turn the timer function ON.
 - The timer indicator above this switch lights green when the timer function is ON.
- ③ Push and hold [POWER] for 1 sec. to turn the power OFF.
 - The timer indicator lights continuously.
- ④ When the set time arrives, the power is automatically turned ON.
- ⑤ The transceiver emits 10 beeps and turns OFF after the power-off period elapses.
 - The timer indicator blinks while beeping.
 - Push [TIMER] momentarily to cancel the sleep timer, if desired.

▨ Timer action in the timer set screen must be selected ON to enable timer operation, described in page 11-3 steps ④.

■ Set mode description	12-2
◇ Set mode operation	12-2
◇ Screen arrangement	12-3
■ Level set mode	12-4
■ ACC set mode	12-7
■ Display set mode	12-9
■ Others set mode	12-12
■ USB-Memory set menu	12-19
◇ USB-Memory set screen arrangement	12-19
◇ Save option set mode	12-20
◇ Load option set mode	12-21
■ File saving	12-22
■ File loading	12-23
■ Changing a file name	12-24
■ Deleting a file	12-25
■ Unmounting USB-Memory	12-25
■ Formatting the USB-Memory	12-26

■ Set mode description

Set mode is used for programming infrequently changed values or conditions of functions. The IC-7700 has a level set mode, display set mode, time set mode, accessory set mode, Others set mode and USB-Memory set menu.

◇ Set mode operation

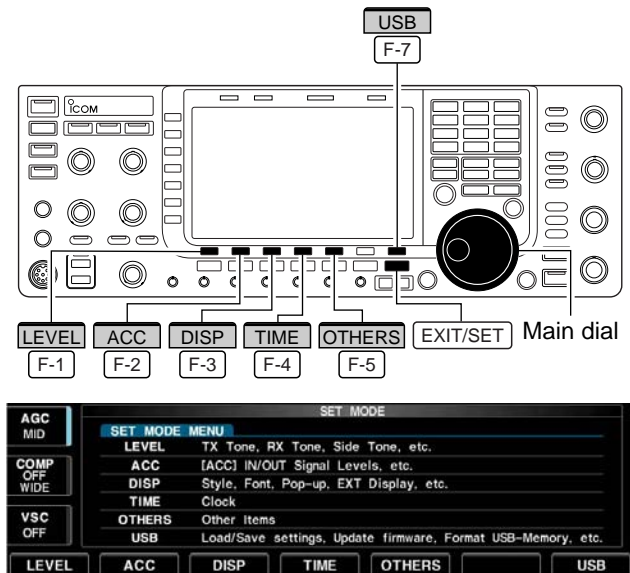

- ① Push [EXIT/SET] several times to close a multi-function screen, if necessary.
- ② Push [F-7•SET] to select set mode menu screen.
 - Pushing and holding [EXIT/SET] for 1 sec. also selects set mode menu screen.
- ③ Push [F-1•LEVEL], [F-2•ACC], [F-3•DISP], [F-4•TIME], [F-5•OTHERS] or [F-7•USB] to enter the desired set mode.
- ④ For level, accessory, display and Others set mode, push [F-7•WIDE] to toggle wide and normal screen.
- ⑤ Push [F-1•▲] or [F-2•▼] to select the desired item, then rotate the main dial to adjust/select the desired value or condition.
 - Pushing [F-3•◀ ▶] operation may be necessary for some items.
- ⑥ Push [EXIT/SET] twice to exit set mode.

◇ Screen arrangement

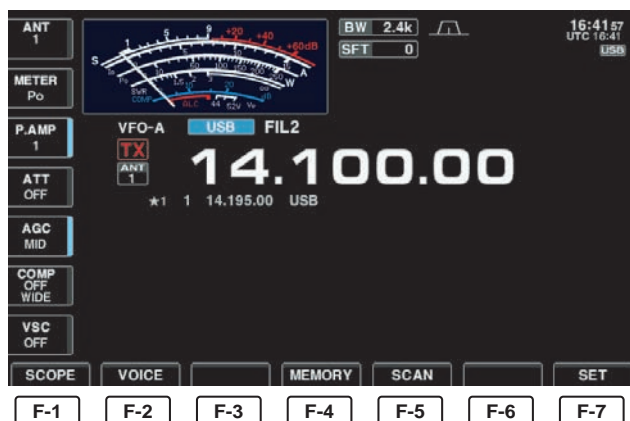

• Display set mode (p. 12-9)



• Set mode menu screen (p. 12-2)

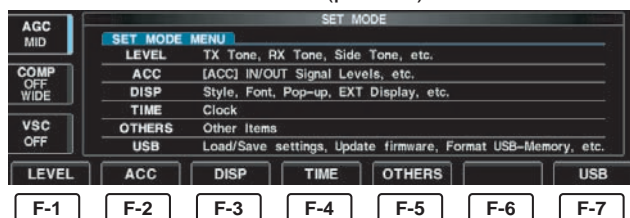

• Time set mode (p. 11-2)

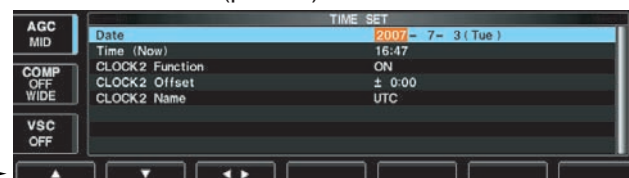

• Level set mode (p. 12-4)

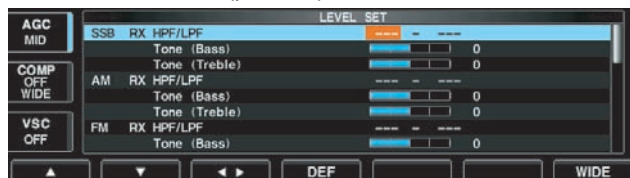

• Others set mode (p. 12-12)

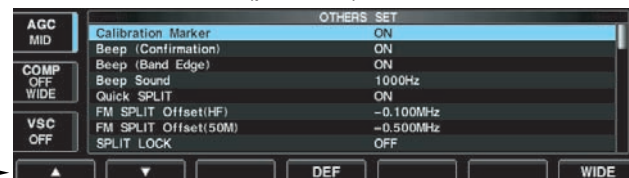

• ACC set mode (p. 12-7)

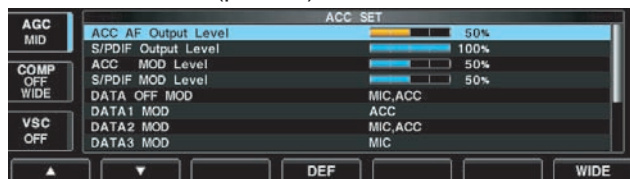

• USB-Memory set menu (p. 12-19)

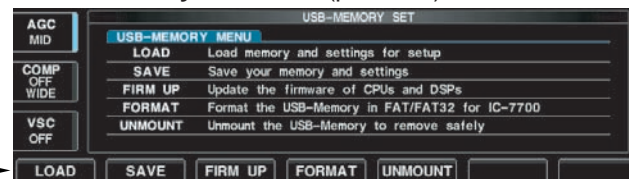

F-2 F-7

■ Level set mode

SSB RX HPF/LPF 

Sets the low-pass filter (100 Hz to 2000 Hz) and high-pass filter (500 Hz to 2400) of the receive audio in 100 Hz steps in SSB mode. (default: OFF)

NOTE: When this setting is active, below 2 items will be reset to default value, '0.'

Tone (Bass)  0

Sets the bass level of the receive audio tone in SSB mode from -5 to +5. (default: 0)

Tone (Treble)  0

Sets the treble level of the receive audio tone in SSB mode from -5 to +5. (default: 0)

AM RX HPF/LPF 

Sets the low-pass filter (100 Hz to 2000 Hz) and high-pass filter (500 Hz to 2400) of the receive audio in 100 Hz steps in AM mode. (default: OFF)

NOTE: When this setting is active, below 2 items will be reset to default value, '0.'

Tone (Bass)  0

Sets the bass level of the receive audio tone in AM mode from -5 to +5. (default: 0)

Tone (Treble)  0

Sets the treble level of the receive audio tone in AM mode from -5 to +5. (default: 0)

FM RX HPF/LPF 

Sets the low-pass filter (100 Hz to 2000 Hz) and high-pass filter (500 Hz to 2400) of the receive audio in 100 Hz steps in FM mode. (default: OFF)

NOTE: When this setting is active, below 2 items will be reset to default value, '0.'

Tone (Bass)  0

Sets the bass level of the receive audio tone in FM mode from -5 to +5. (default: 0)

Tone (Treble)  0

Sets the treble level of the receive audio tone in FM mode from -5 to +5. (default: 0)

■ Level set mode (continued)

CW RX HPF/LPF 

Sets the low-pass filter (100 Hz to 2000 Hz) and high-pass filter (500 Hz to 2400) of the receive audio in 100 Hz steps in CW mode. (default: OFF)

RTTY RX HPF/LPF 

Sets the low-pass filter (100 Hz to 2000 Hz) and high-pass filter (500 Hz to 2400) of the receive audio in 100 Hz steps in RTTY mode. (default: OFF)

PSK RX HPF/LPF 

Sets the low-pass filter (100 Hz to 2000 Hz) and high-pass filter (500 Hz to 2400) of the receive audio in 100 Hz steps in PSK mode. (default: OFF)

SSB TX Tone (Bass)  0

Sets the bass level of the transmit audio tone in SSB mode from -5 to +5. (default: 0)

Tone (Treble)  0

Sets the treble level of the transmit audio tone in SSB mode from -5 to +5. (default: 0)

AM TX Tone (Bass)  0

Sets the bass level of the transmit audio tone in AM mode from -5 to +5. (default: 0)

Tone (Treble)  0

Sets the treble level of the transmit audio tone in AM mode from -5 to +5. (default: 0)

FM TX Tone (Bass)  0

Sets the bass level of the transmit audio tone in FM mode from -5 to +5. (default: 0)

Tone (Treble)  0

Sets the treble level of the transmit audio tone in FM mode from -5 to +5. (default: 0)

■ Level set mode (continued)

SSB TBW (WIDE)	100 – 2900
Sets the transmission passband width to wide setting by changing the lower and higher cut-off frequencies.	Lower freq. : 100 (default), 200, 300 and 500 Hz Higher freq.: 2500, 2700, 2800 and 2900 Hz (default)

SSB TBW (MID)	300 – 2700
Sets the transmission passband width to middle setting by changing the lower and higher cut-off frequencies.	Lower freq. : 100, 200, 300 (default) and 500 Hz Higher freq.: 2500, 2700 (default), 2800 and 2900 Hz

SSB TBW (NAR)	500 – 2500
Sets the transmission passband width to narrow setting by changing the lower and higher cut-off frequencies.	Lower freq. : 100, 200, 300 and 500 Hz (default) Higher freq.: 2500 (default), 2700, 2800 and 2900 Hz

Speech Level	 50%
Sets the voice synthesizer audio output level from 0 to 100% in 1% steps. (default: 50%)	

Side Tone Level	 50%
Sets the side tone output level from 0 to 100% in 1% steps. (default: 50%)	

Side Tone Level Limit	ON
Turns the side tone output level limiting capability from ON and OFF. (default: ON)	

Beep Level	 50%
Sets the key-touch beep output level from 0 to 100% in 1% steps. (default: 50%)	

Beep Level Limit	ON
Turns the key-touch beep output level limiting capability from ON and OFF. (default: ON)	

Phones Level Ratio	 1.00
Sets the ratio for audio output level from the head-phone toward to the internal speaker within a range of 0.60 to 1.40 in 0.01 steps. (default: 1.00)	

■ ACC set mode

ACC AF Output Level		50%
Sets the desired audio output level, output from [ACC1], within 0 to 100% in 1% steps.		
<ul style="list-style-type: none"> • Outputs approx. 200 mV at 50% (default) setting. 		

S/PDIF Output Level		100%
Sets the desired output level of [S/P DIF], within 0 to 100% in 1% steps. (default: 100%)		

ACC MOD Level		50%
Sets the desired audio input level for modulation from [ACC1].		
<ul style="list-style-type: none"> • Approx. 100 mV at 50% (default) setting. 		

S/PDIF MOD Level		50%
Sets the desired input level for modulation from [S/P DIF], within 0 to 100% in 1% steps. (default: 50%)		

DATA OFF MOD	MIC,ACC
Selects the desired connector(s) for modulation input when data mode is not in use.	<ul style="list-style-type: none"> • MIC : Use the signals from [MIC]. • ACC : Use the signals from [ACC1] (pin 4). • MIC,ACC : Use the signals from [MIC] and [ACC1] (pin 4). (default) • S/P DIF : Use the signals from [S/P DIF].

DATA1 MOD	ACC
Selects the desired connector(s) for modulation input when data 1 mode (D1) is in use.	<ul style="list-style-type: none"> • MIC : Use the signals from [MIC]. • ACC : Use the signals from [ACC1] (pin 4). (default) • MIC,ACC : Use the signals from [MIC] and [ACC1] (pin 4). • S/P DIF : Use the signals from [S/P DIF].

DATA2 MOD	MIC,ACC
Selects the desired connector(s) for modulation input when data 2 mode (D2) is in use.	<ul style="list-style-type: none"> • MIC : Use the signals from [MIC]. • ACC : Use the signals from [ACC1] (pin 4). • MIC,ACC : Use the signals from [MIC] and [ACC1] (pin 4). (default) • S/P DIF : Use the signals from [S/P DIF].

■ ACC set mode (continued)

DATA3 MOD	MIC
Selects the desired connector(s) for modulation input when data 3 mode (D3) is in use.	<ul style="list-style-type: none"> • MIC : Use the signals from [MIC]. (default) • ACC : Use the signals from [ACC1] (pin 4). • MIC,ACC : Use the signals from [MIC] and [ACC1] (pin 4). • S/P DIF : Use the signals from [S/P DIF].

SEND Relay Type	Lead
Selects the switching relay type for [RELAY] from Lead and MOSFET. Select the suitable relay type when connecting a non-lcom linear amplifier.	<ul style="list-style-type: none"> • Lead : Use mechanical relay. (16 V DC/0.5 A max.; default) • MOS-FET: Use semiconductor type relay. (250 V/200 mA max.)

External Meter Output	Auto
Selects the desired item for an external meter indication.	<ul style="list-style-type: none"> • Auto : Outputs the receiving signal strength level during receive, and outputs the selected level (selected with [METER]), during transmit. (default) • S : Outputs the receiving signal strength level during receive. • Po : Outputs the transmitting power level during transmit. • SWR : Outputs the VSWR level during transmit. • ALC : Outputs the ALC level during transmit. • COMP : Outputs the compression level during transmit. • V_D : Outputs the drain terminal voltage of the final amplifier MOSFETs. • I_D : Outputs the drain current of the final amplifier MOSFETs.

External Meter Level	 50%
Sets the output level for an external meter indication with in 0 to 100% range in 1% steps.	<ul style="list-style-type: none"> • Approx. 2.5 V at 50% (default) setting for full-scale indication. (4.7 kΩ impedance)

■ ACC set mode (continued)

REF IN/OUT	OFF
<p>Selects the transceiver's reference signal condition from IN, OFF and OUT.</p>	<ul style="list-style-type: none"> • IN : Use an external reference signal for the IC-7700. Turn the transceiver power OFF then ON to make the setting effective. • OFF : Not input/output the reference signal. (default) • OUT : Outputs the IC-7700 reference signal to externally connected equipment(s) for their reference. <p>/// NOTE: If the applied reference signal is off-frequency, or no signal is applied with "IN" selection, the IC-7700 will not work properly. Select "OFF" or "OUT" then reboot the IC-7700 in such case.</p>

REF Adjust	 50%
<p>Adjusts the internal reference signal frequency within 0 to 100% range in 1% steps during frequency calibration.</p>	<p>/// NOTE: Default setting is different for each transceiver.</p>

■ Display set mode

LCD Unit Bright	 50%
<p>Adjusts the LCD unit brightness from 0 (dark) to 100% (bright) range in 1% steps. (default: 50%)</p>	

Backlight (Switches)	 80
<p>Adjusts the switch indicators brightness from 1 (dark) to 100 (bright) range in 1 steps. (default: 80)</p>	

Display Type	A
<p>Selects the desired display type from A (Black back) and B (Blue back). (default: A)</p>	<p>See p.13-4 for details.</p>

Display Font	Basic (1)
<p>Selects the desired font for frequency readout from Basic (1), Basic (2), Italic, Round and Slim. (default: Basic (1))</p>	<p>See p.13-4 for details.</p>

■ Display set mode (continued)

Meter Response	MID
Set meter needle response from SLOW, MID and FAST. (default: MID)	This setting is effective for the standard and edge-wise meter type selections only.
Meter Type (Normal Screen)	Standard
Selects the desired S/RF meter type during normal screen indication from Standard, Edgewise and Bar. (default: Standard)	
Meter Type (Wide Screen)	Bar
Selects the desired S/RF meter type during wide screen or mini scope indication from Edgewise and Bar. (default: Bar)	
Meter Peak Hold (Bar)	ON
Turns the meter peak hold function ON and OFF. (default: ON) This function is used for the bar meter only.	
Memory Name	ON
Sets the memory name indication, during memory mode operation, ON and OFF. (default: ON)	<ul style="list-style-type: none"> • ON : The programmed memory name is displayed above the frequency indication. • OFF : No memory name is displayed even a memory name is programmed.
APF-Width Popup (APF OFF→ON)	ON
Selects the pop-up display for the APF filter width from ON and OFF. (default: ON)	
MN-Q Popup (MN OFF→ON)	ON
Enables the pop-up indication capability when the notch filter width is changed from ON to OFF. (default: ON)	



■ Display set mode (continued)

<p>Screen Saver Function</p> <p>Turns the screen saver function ON (15, 30 or 60 minutes) and OFF. (default: 60 min.)</p>	<p>60min</p> <p>The screen saver will activate when no operation is performed for the selected time period to protect the LCD from the "burn-in" effect.</p>
<p>Screen Saver Type</p> <p>Selects the screen saver type from "Bound," "Rotation" and "Twist." (default: Bound)</p>	<p>Bound</p> <p>The screen saver indication can be displayed for your reference while pushing and holding [F-5•PREVIEW].</p>
<p>External Display</p> <p>Select "ON" when the external display is connected. (default: OFF)</p>	<p>OFF</p> <ul style="list-style-type: none"> • At least 800×600 pixel resolution is required for the display.
<p>External Display Sync Pulse</p> <p>Selects the suitable pulse level for the connected external display from H and L. (default: H)</p>	<p>H</p>
<p>Opening Message</p> <p>Turns the opening message screen indication capability ON and OFF. (default: ON)</p>	<p>ON</p>
<p>My Call</p> <p>Sets the introductory text, up to 10-character long, displayed in the opening screen. Usually, you set your call sign for the opening screen. Capital letters, small letters, numerals, some symbols (- / . @) and spaces can be used.</p> <ol style="list-style-type: none"> 1 Push [F-5•EDIT] to select the name edit condition. <ul style="list-style-type: none"> • The cursor under the 1st character blinks. 2 Push [ABC] (MF6), [abc] (MF6), [123] (MF7) or [Symbol] (MF7) to select the character group, then rotate the main dial to select the character. <ul style="list-style-type: none"> • Push [ABC] (MF6) or [abc] (MF6) to toggle capital and small letters. • Push [123] (MF7) or [Symbol] (MF7) to toggle numerals and symbols. • Push [F-1•◀] or [F-2•▶] for cursor movement. • Push [F-3•DEL] to delete the selected character. • Push [F-4•SPACE] to input a space. • Pushing the transceiver's keypad, [0]–[9], can also enter numerals. 3 Push [EXIT/SET] to set the name. 	

Others set mode

Calibration Marker	OFF
<p>This item is used for a simple frequency check of the transceiver. (default: OFF) See p. 13-5 for calibration procedure.</p> <p>NOTE: Turn the calibration marker OFF after checking the frequency of the transceiver.</p>	

Beep (Confirmation)	ON
<p>A beep sounds each time a switch is pushed to confirm it. This function can be turned OFF for silent operation. (default: ON)</p> <p>The beep output level can be set in level set mode. (p. 12-6)</p>	

Beep (Band Edge)	ON
<p>A beep sounds when an operating frequency enters or exits an amateur band. This functions independent of the confirmation beep setting (above). (default: ON)</p> <p>The beep output level can be set in level set mode. (p. 12-6)</p>	

Beep Sound	1000Hz
<p>Sets the desired key-touch beep sound frequency within 500 to 2000 Hz in 10 Hz steps. (default: 1000 Hz)</p>	

Quick SPLIT	ON
<p>When this item is set to ON, pushing and holding SPLIT for 1 sec. sets the unselected VFO's readout frequency to the selected VFO's readout frequency and activates split operation. (default: ON)</p>	<p>See p. 6-7 for details.</p>

■ Others set mode (continued)

FM SPLIT Offset(HF) -0.100MHz

Sets the offset (difference between transmit and receive frequencies) for the quick split function. This setting is used for HF bands in FM mode only and is used to input the repeater offset for an HF band.

The offset frequency can be set from -9.999 MHz to +9.999 MHz in 1 kHz steps. (default: -0.100 MHz)

FM SPLIT Offset(50M) -0.500MHz

Sets the offset (difference between transmit and receive frequencies) for the quick split function. This setting is used for 50 MHz band FM mode only, and is used to input the repeater offset for the 50 MHz band.

The offset frequency can be set from -9.999 MHz to +9.999 MHz in 1 kHz steps. (default: -0.500 MHz)

SPLIT LOCK OFF

When this item is ON, the main dial can be used to adjust the transmit frequency while pushing [XFC] even while the lock function is activated.
(default: OFF)

See pgs. 6-6, 6-7 for split frequency operation details.

Tuner (Auto Start) OFF

The internal antenna tuner has an automatic start capability which starts tuning if the SWR is higher than 1.5-3:1.

- OFF : The tuner remains OFF even when the SWR is poor (1.5-3:1). (default)
- ON : Automatic tune starts even when the tuner is turned OFF during HF bands operation.

Tuner (PTT Start) OFF

Tuning of the internal antenna tuner can be started automatically at the moment the PTT is pushed after the operating frequency is changed (more than 1% from last-tuned frequency). (default: OFF)

Others set mode (continued)

Transverter Function	Auto
<p>Selects the transverter operation condition from Auto and ON. (default: Auto)</p>	<ul style="list-style-type: none"> • ON : Turn the transverter operation ON. • Auto: The transceiver turns into transverter operation condition when 2 to 13.8 V DC is applied to [ACC2] pin 6.

Transverter Offset	16.000MHz (14.000.00→30.000.00)
<p>Sets the desired offset frequency for the transverter operation within 0.000 to 99.999 MHz in 1 kHz steps. (default: 16.000 MHz)</p>	

RTTY Mark Frequency	2125
<p>Selects the RTTY mark frequency. RTTY mark frequency is switched between 1275, 1615 and 2125 Hz. (default: 2125 Hz)</p> <p>2125 Hz is automatically selected when the internal RTTY decoder is used.</p>	

RTTY Shift Width	170
<p>Selects the RTTY shift width. There are 3 selectable values: 170, 200 and 425 Hz. (default: 170 Hz)</p> <p>170 Hz is automatically selected when the internal RTTY decoder is used.</p>	

RTTY Keying Polarity	Normal
<p>Selects the RTTY keying polarity. Normal or reverse keying polarity can be selected. (default: Normal)</p>	<p>When reverse polarity is selected, Mark and Space are reversed.</p> <ul style="list-style-type: none"> • Normal : Key open/close = Mark/Space • Reverse : Key open/close = Space/Mark

PSK Tone Frequency	1500
<p>Selects the desired PSK tone frequency for the PSK reception from 1000, 1500 and 2000 Hz. (default: 1500 Hz)</p>	

SPEECH Language	English
<p>Selects the speech language from English and Japanese. (default: English)</p>	

SPEECH Speed	HIGH
<p>Selects the speech speed from HIGH (faster) and LOW (slower). (default: HIGH)</p>	

■ Others set mode (continued)

SPEECH S-Level ON

The IC-7700 speech processor has frequency, mode and signal level announcement. Signal level announcement can be deactivated if desired. (default: ON)

When "OFF" is selected, the signal level is not announced.

SPEECH [MODE] Switch OFF

Selects the operating mode speech capability when a mode switch is pushed; ON or OFF. (default: OFF)

When "ON" is selected, the selected operating mode is announced when a mode switch is pushed.

Memopad Numbers 5

Sets the number of memo pad channels available. 5 or 10 memo pads can be set. (default: 5)

MAIN DIAL Auto TS HIGH

Sets the auto tuning step function for the main dial. When rotating the main dial rapidly, the tuning step automatically changes several times as selected.

There are 2 type of auto tuning steps: HIGH (Fastest) and LOW (Faster). (default: HIGH)

- HIGH : Auto tuning step is turned ON. Fastest tuning step during rapid rotation. (default)
- LOW : Auto tuning step is turned ON. Faster tuning step during rapid rotation.
- OFF : Auto tuning step is turned OFF.

MIC Up/Down Speed HIGH

Sets the rate at which frequencies are scanned when the microphone [UP]/[DN] switches are pushed and held. High or low can be selected.

- HIGH : High speed (default; 50 tuning steps/sec.)
- LOW : Low speed (25 tuning steps/sec.)

Quick RIT/ Δ TX Clear OFF

Selects the RIT/ Δ TX frequency clearing instruction with the switch.

- ON : Clears the RIT/ Δ TX frequency when is pushed momentarily.
- OFF : Clears the RIT/ Δ TX frequency when is pushed and held for 1 sec. (default)

Others set mode (continued)

[NOTCH] Switch (SSB)	Auto/Manual
Selects notch functions for SSB mode operation from Auto, Manual and Auto/Manual.	<ul style="list-style-type: none"> • Auto : Only the auto notch can be used. • Manual : Only the manual notch can be used. • Auto/Manual : Both the auto and manual notch can be used. (default)

[NOTCH] Switch (AM)	Auto/Manual
Selects notch functions for AM mode operation from Auto, Manual and Auto/Manual.	<ul style="list-style-type: none"> • Auto : Only the auto notch can be used. • Manual : Only the manual notch can be used. • Auto/Manual : Both the auto and manual notch can be used. (default)

DIGI-SEL VR Operation	DIGI-SEL
Selects [DIGI-SEL] control function from DIGI-SEL and APF.	<ul style="list-style-type: none"> • DIGI-SEL : [DIGI-SEL] control functions as the digital selector operation. (default) • APF : [DIGI-SEL] control functions as the audio peak filter adjustment.

SSB/CW Synchronous Tuning	OFF
<p>Selects the displayed frequency shift function from ON and OFF. (default: OFF)</p> <p>When this function is activated, the audio pitch or tones of the received signal will remain the same even when the operating mode is changed between SSB and CW.</p> <p>/// The frequency shifting value may differ according to the CW pitch setting.</p>	<ul style="list-style-type: none"> • ON : The displayed frequency shifts when the operating mode is changed between SSB and CW. • OFF : The displayed frequency does not shift.

CW Normal Side	LSB
Selects the side band used to receive CW in CW normal mode. (default: LSB)	

APF Type	SHARP
Set audio filter shape for APF from SOFT and SHARP. (default: SOFT)	<ul style="list-style-type: none"> • SOFT : Soft filter shape makes distinguishing noise and signals easier. The audio filter width is related to the CW pitch setting. • SHARP : Sharp filter shape rejects interference signals.

■ Others set mode (continued)

External Keypad (VOICE)	OFF
Sets the external keypad for voice message transmission capability ON and OFF.	<ul style="list-style-type: none"> • ON : Pushing one of external keypad switches, transmits the desired voice message contents during a phone mode operation. • OFF : External keypad does not function. (default)
See page 2-7 for the equivalent circuit of an external keypad and connection.	

External Keypad (KEYER)	OFF
Sets the external keypad for keyer memory transmission capability ON and OFF.	<ul style="list-style-type: none"> • ON : Pushing one of external keypad switches, transmits the desired keyer memory contents during CW mode operation. • OFF : External keypad does not function. (default)
See page 2-7 for the equivalent circuit of an external keypad and connection.	

CI-V Baud Rate	Auto
Sets the CI-V data transfer rate. 300, 1200, 4800, 9600, 19200 bps and "Auto" are available. (default: Auto)	
When "Auto" is selected, the baud rate is automatically set according to the data rate of connected controller.	

CI-V Address	74h
To distinguish equipment, each CI-V transceiver has its own Icom standard address in hexadecimal code. The IC-7700's address is 74h.	
When 2 or more IC-7700's are connected to an optional CT-17 CI-V LEVEL CONVERTER, rotate the main dial to select a different address for each IC-7700; the range is 01h to 7Fh.	

CI-V Transceive	ON
Transceive operation is possible with the IC-7700 connected to other Icom HF transceivers or receivers.	
When "ON" is selected, changing the frequency, operating mode, etc. on the IC-7700 automatically changes those of connected transceivers (or receivers) and vice versa.	

■ Others set mode (continued)

RS-232C Function	CI-V
Select [RS-232C] connector output data format from CI-V and Decode.	<ul style="list-style-type: none"> • CI-V : Outputs data in CI-V format. (default) • Decode : Outputs decoded contents in ASCII code format.

Decode Baud Rate	9600
Selects data transmission speed (Baud rate) when "Decode" is selected in "RS-232C Function" above; settings are 300, 1200, 4800, 9600 and 19200 bps. (default: 9600)	

Keyboard Type	English
Selects the connected keyboard type from Japanese, English, United Kingdom, French, French (Canadian), German, Portuguese, Portuguese (Brazilian), Spanish, Spanish (Latin American) and Italian. (default: English)	

Keyboard Repeat Delay	250ms
Sets the time period for delay within 100 to 1000 msec. in 50 msec. steps. (default: 250 msec.)	
When a key of the connected keyboard is pressed and held for the set period, the character is input continuously.	

Keyboard Repeat Rate	10.9cps
Sets the repeating rate for the connected keyboard within 2.0 to 30.0 cps. (default: 10.9 cps) *cps=character per second	<ul style="list-style-type: none"> • Available repeating rate 2.0, 2.1, 2.3, 2.5, 2.7, 3.0, 3.3, 3.7, 4.0, 4.3, 4.6, 5.0, 5.5, 6.0, 6.7, 7.5, 8.0, 8.6, 9.2, 10.0, 10.9, 12.0, 13.3, 15.0, 16.0, 17.1, 18.5, 20.0, 21.8, 24.0, 26.7, 30.0
When a key of the connected keyboard is pressed and held, the character is repeatedly input with the set speed.	

IP Address (Valid after Reboot)	192. 168. 0. 1
Sets IP address for the IC-7700 when connecting to your PC or LAN (Local Area Network) through the Ethernet connector.	Turn the transceiver power OFF then ON to make the setting effective. See p. 16-7 for details.

Subnet Mask (Valid after Reboot)	255. 255. 255. 0 (24bit)
Sets subnet mask for the IC-7700 when connecting to your PC or LAN (Local Area Network) through the Ethernet connector.	Turn the transceiver power OFF then ON to make the setting effective. See p. 16-7 for details.

■ USB-Memory set menu

◇ USB-Memory set screen arrangement

• USB-Memory set menu

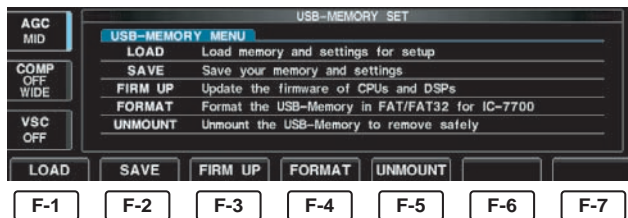

• Setting load screen (p. 12-23)

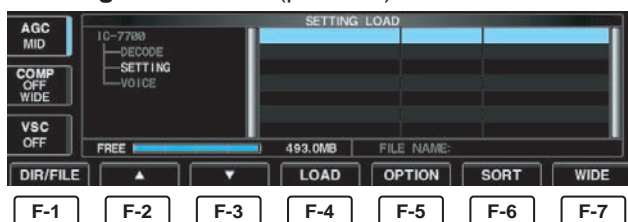

• Load option set mode (p. 12-21)

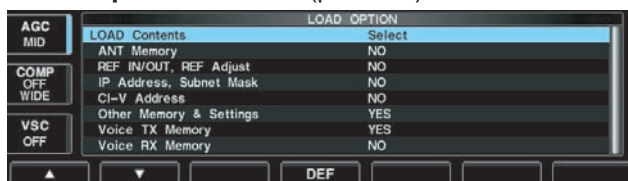

• Setting save screen (p. 12-22)

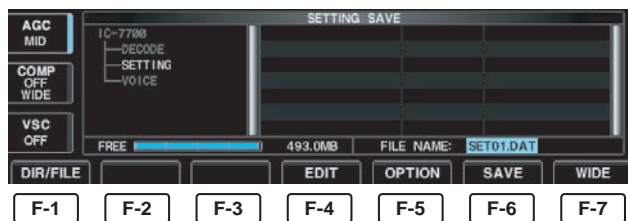

• Save option set mode (p. 12-20)

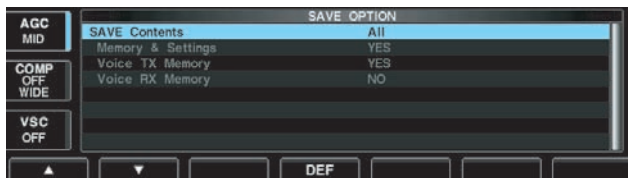

• Firmware update (p. 16-4)

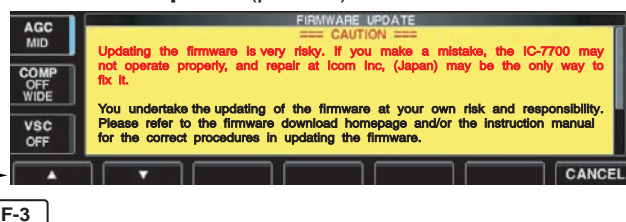

• Format menu (p. 12-26)



• Unmount USB-Memory (p. 12-25)



◇ Save option set mode

SAVE Contents	All
Selects file save condition from All and Select. (default: All)	<ul style="list-style-type: none">• All : Saves all the following contents.• Select : Saves the selected contents only.
Memory & Settings	YES
This setting is fixed "YES."	<ul style="list-style-type: none">• YES : Saves memory channel contents and settings of set modes.
Voice TX Memory	YES
Selects the voice TX message save condition from YES and NO. (default: YES)	<ul style="list-style-type: none">• YES : Saves the voice TX message.• NO : Does not save.
Voice RX Memory	NO
Selects the voice RX message save condition from YES and NO. (default: NO)	<ul style="list-style-type: none">• YES : Saves the voice RX message.• NO : Does not save.

◇ Load option set mode

Load Contents Selects file load condition from All and Select. (default: Select)	Select <ul style="list-style-type: none"> • All : Loads and sets the all following contents. • Select : Loads and sets the selected contents only.
ANT Memory Selects the antenna memory setting loading condition YES and NO. (default: NO).	NO <ul style="list-style-type: none"> • YES : Loads and sets the antenna memory. • NO : Use the original antenna memory setting.
REF IN/OUT, REF Adjust Selects the reference signal setting load condition YES and NO. (default: NO).	NO <ul style="list-style-type: none"> • YES : Loads and sets the reference signal setting. • NO : Use the original reference signal setting.
IP Address, Subnet Mask Selects the IP address and subnet mask setting load condition YES and NO. (default: NO).	NO <ul style="list-style-type: none"> • YES : Loads and sets the IP address and subnet mask setting. • NO : Use the original IP address and subnet mask setting.
CI-V Address Selects the CI-V address setting load condition YES and NO. (default: NO).	NO <ul style="list-style-type: none"> • YES : Loads and sets the CI-V address setting. • NO : Use the original CI-V address setting.
Other Memory & Settings Selects memory channel contents and other settings load condition YES and NO. (default: YES).	YES <ul style="list-style-type: none"> • YES : Loads and sets memory channel contents and other settings. • NO : Use the original memory channel contents and other settings.
Voice TX Memory Selects the voice TX message load condition YES and NO. (default: YES).	YES <ul style="list-style-type: none"> • YES : Loads and sets voice TX message. • NO : Use the original voice TX message.
Voice RX Memory Selects the voice RX message load condition YES and NO. (default: NO).	YES <ul style="list-style-type: none"> • YES : Loads and sets voice RX message. • NO : Use the original voice RX message.

File saving

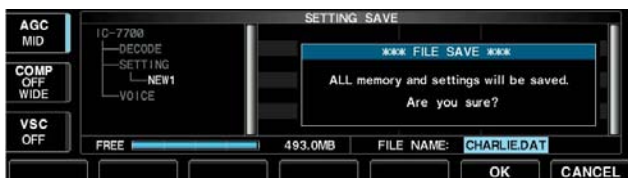
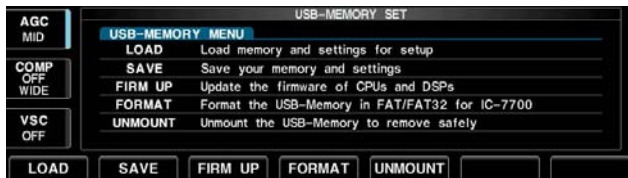
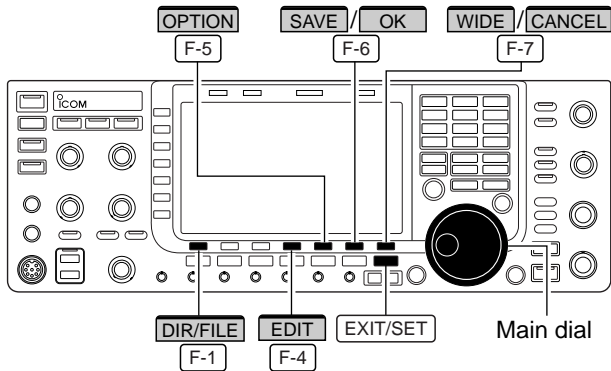

Memory channel contents, set mode settings, etc. can be saved into the USB-Memory for backup.

- ① During set mode menu screen indication, push [F-7•USB] to select USB-Memory set menu screen.
- ② Push [F-2•SAVE] to select setting save screen.
- ③ Change the following conditions if desired.

• **File name:**

- ① Push [F-4•EDIT] to select file name edit condition.
 - Push [F-1•DIR/FILE] several times to select the file name, if necessary.
- ② Push [ABC] (MF6), [123] (MF7) or [Symbol] (MF7) to select the character group, then rotate the main dial to select the character.
 - [ABC] (MF6): A to Z (capital letters); [123] (MF7): 0 to 9 (numerals); [Symbol] (MF7): ! # \$ % & ' ` ^ + - = () [] { } _ ~ @ can be selected.
 - Push [F-1•◀] to move the cursor left, push [F-2•▶] to move the cursor right, push [F-3•DEL] to delete a character and push [F-4•SPACE] to insert a space.
- ③ Push [EXIT/SET] to set the file name.

• **Save option**

- ① Push [F-5•OPTION] to enter save option set mode.
- ② Push [F-1•▲] or [F-2•▼] to select the item, then rotate the main dial to select the desired setting. (see p. 12-20 for details)
 - “Text” is the default setting.
 - Push and hold [F-4•DEF] for 1 sec. to select the default setting.
- ③ Push [EXIT/SET] to return to the previous indication.

• **Saving location**

- ① Push [F-1•DIR/FILE] to select tree view screen.
- ② Select the desired directory or folder in the USB-Memory.
 - Push [F-4•◀▶] to select the upper directory.
 - Push [F-2•▲] or [F-3•▼] to select folder in the same directory.
 - Push and hold [F-4•◀▶] for 1 sec. to select a folder in the directory.
 - Push [F-5•REN/DEL] to rename the folder.
 - Push and hold [F-5•REN/DEL] for 1 sec. to delete the folder.
 - Push and hold [F-6•MAKE] for 1 sec. to making a new folder. (Edit the name with the same manner as the “• File name” above.)
- ③ Push [F-1•DIR/FILE] twice to select the file name.

- ④ Push [F-6•SAVE].
 - Confirmation screen appears.
- ⑤ Push [F-6•OK] to save.
 - After saving is completed, return to USB-Memory set menu automatically.

■ File loading

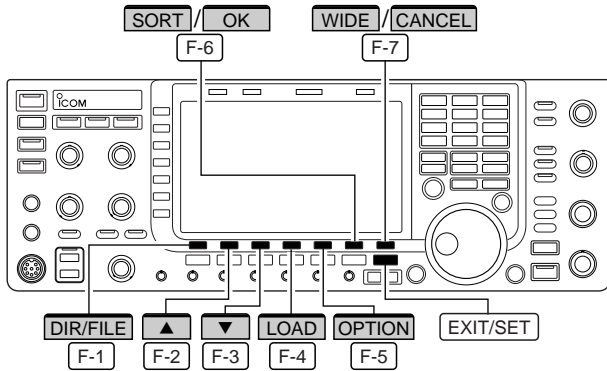

By loading the saved setting file from the USB-Memory, you can easily set up another IC-7700—several operators settings can easily be applied to one IC-7700.

- ① During set mode menu screen indication, push [F-7•USB] to select USB set menu screen.
- ② Push [F-1•LOAD] to select setting load screen.
 - The indicator above the USB connectors and “USB” indicator on the display blink.
 - After the USB-Memory contents are displayed, the indicators stop blinking.
- ③ Push [F-5•OPTION] to select load option set mode, then set the desired loading conditions, if desired.
 - See page 12-21 for details.
- ④ Push [F-2•▲] or [F-3•▼] to select the desired setting file.
- ⑤ Push [F-4•LOAD].
 - Confirmation screen appears.
- ⑥ Push [F-6•OK] to starts loading.
 - After the loading is completed, the message dialog, “Reboot the IC-7700,” appears.
- ⑦ Turn the transceiver power OFF then ON to make the setting effective.



■ Changing a file name

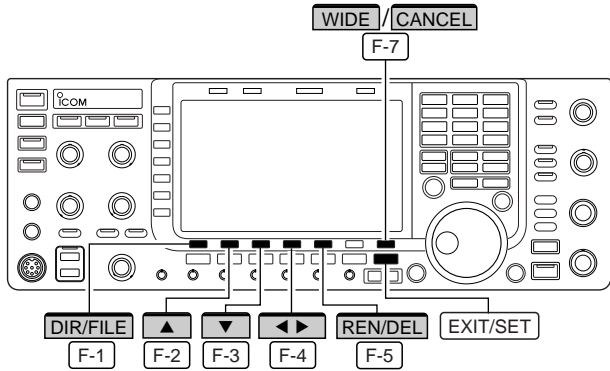

The file name, saved in the USB-Memory, can be re-named from the transceiver as desired.

- ① During setting save screen display, push [F-1•DIR/FILE] to select tree view screen.
 - Push [F-2•▲] or [F-3•▼] to select the desired folder.
 - “DECODE,” “SETTING” and “VOICE” folders are available as the default.
 - After the folder is selected, push and hold [F-4•◀▶] for 1 sec. to display content folder(s), if available.
- ② Push [F-1•DIR/FILE] to select file list screen.
- ③ Push [F-2•▲] or [F-3•▼] to select the desired file.
- ④ Push [F-5•REN/DEL] momentarily to select the file name edit condition.
- ⑤ Push [ABC] (MF6), [123] (MF7) or [Symbol] (MF7) to select the character group, then rotate the main dial to select the character.
 - [ABC] (MF6): A to Z (capital letters); [123] (MF7): 0 to 9 (numerals); [Symbol] (MF7): ! # \$ % & ' ` ^ + - = () [] { } _ ~ @ can be selected.
 - Push [F-1•◀] to move the cursor left, push [F-2•▶] to move the cursor right, push [F-3•DEL] to delete a character and push [F-4•SPACE] to insert a space.
 - Pushing the transceiver’s keypad, [0]–[9], can also enter numerals.
- ⑥ Push [EXIT/SET] to set the file name.

■ Deleting a file



RECOMMENDATION! Deleting the setting file is irreversible. Confirm the contents before deleting a setting file!

- ① During setting save screen display, push [F-1•DIR/FILE] to select tree view screen.
 - Push [F-2•▲] or [F-3•▼] to select the desired folder.
 - “DECODE,” “SETTING” and “VOICE” folders are available as the default.
 - After the folder is selected, push and hold [F-4•◀▶] for 1 sec. to display content folder(s), if available.
- ② Push [F-1•DIR/FILE] to select file list screen.
- ③ Push [F-2•▲] or [F-3•▼] to select the desired file to be deleted.
- ④ Push and hold [F-5•REN/DEL] for 1 sec.
 - Confirmation screen appears.
- ⑤ Push [F-6•OK] to delete.
 - After the deleting, return to setting save screen automatically.

■ Unmounting USB-Memory



CAUTION! When removing the USB-Memory, unmount operation is necessary. If you do not unmount the memory in this case, data in the USB memory may be corrupted.

- ① Push and hold [F-6•UNMOUNT] for 1 sec.
 - Confirmation screen appears.
- ② Push [F-6•OK] to unmount the USB-Memory.
- ③ After “USB” indication disappears, remove the USB-Memory.

■ Formatting the USB-Memory

Saved data in the USB-Memory can be erased.

IMPORTANT! Formatting erases all saved data in the USB-Memory. Making a backup file on your PC is recommended.

- ① During USB-Memory set menu display, push and hold [F-4•FORMAT] for 1 sec.
 - Confirmation screen appears.
- ② Push [F-6•FAT] or [F-7•FAT32] to select the format type, FAT or FAT32, respectively.
 - Confirmation screen appears.
- ③ Push [F-6•OK] to format.
 - Push [F-7•CANCEL] to cancel.
- ④ Returns to USB-Memory set menu indication automatically.



NOTE: If no USB-Memory is inserted and [F-4•FORMAT] is selected as in step ①, an error message appears.

■ Troubleshooting	13-2
◇ Transceiver power	13-2
◇ Transmit and receive	13-2
◇ Scanning	13-3
◇ Display	13-3
◇ Format USB-Memory	13-3
■ Main dial brake adjustment	13-3
■ SWR reading	13-4
■ Screen type and font selections	13-4
■ Frequency calibration (approximate)	13-5
■ Opening the transceiver's case	13-6
■ Clock backup battery replacement	13-6
■ Fuse replacement	13-7
■ Resetting the CPU	13-7
■ About protection indications	13-8
■ Screen Saver Function	13-8

■ Troubleshooting

The following chart is designed to help you correct problems which are not equipment malfunctions. If you are unable to locate the cause of a problem or solve it through the use of this chart, contact your nearest Icom Dealer or Service Center.

◇ Transceiver power

PROBLEM	POSSIBLE CAUSE	SOLUTION	REF.
Power does not come on when the [POWER] switch is pushed.	<ul style="list-style-type: none"> • Power cable is improperly connected. • The internal power supply is turned OFF. • Circuit breaker is tripped. 	<ul style="list-style-type: none"> • Re-connect the AC power cable correctly. • Turn the internal power supply ON. • Check for the cause, then re-set the circuit breaker. 	<p>p. 2-5 p. 3-2 —</p>

◇ Transmit and receive

PROBLEM	POSSIBLE CAUSE	SOLUTION	REF.
No sounds from the speaker.	<ul style="list-style-type: none"> • Volume level is too low. • The squelch is closed. • The transceiver is in transmit. 	<ul style="list-style-type: none"> • Rotate [AF] clockwise to obtain a suitable listening level. • Turn [SQL] to 10 o'clock position to open the squelch. • Push [TRANSMIT] to receive or check the SEND line of an external unit, if connected. 	<p>p. 3-9 p. 3-9 p. 3-12</p>
Sensitivity is too low, and only strong signals are audible.	<ul style="list-style-type: none"> • The antenna is not connected properly. • The antenna for another band is selected. • The antenna is not properly tuned. • The attenuator is activated. 	<ul style="list-style-type: none"> • Re-connect to the antenna connector. • Select an antenna suitable for the operating frequency. • Push and hold [TUNER] for 1 sec. to manually tune the antenna. • Push [ATT] (MF4) several times to select "ATT OFF." 	<p>— p. 10-2 p. 10-6 p. 5-9</p>
Received audio is unclear or distorted.	<ul style="list-style-type: none"> • Wrong operating mode is selected. • PBT function is activated. • Noise blanker is turned ON when receiving a strong signal. • Preamp is activated. • The noise reduction is activated and the [NR] control is too far clockwise. 	<ul style="list-style-type: none"> • Select a suitable operating mode. • Push and hold [PBT-CLR] for 1 sec. to reset the function. • Push [NB] to turn the noise blanker OFF. • Push [P.AMP] (MF3) once or twice to turn the function OFF. • Set the [NR] control for maximum readability. 	<p>p. 3-8 p. 5-12 p. 5-16 p. 5-9 p. 5-17</p>
The [ANT] switch does not function	<ul style="list-style-type: none"> • The antenna switch has not been activated. 	<ul style="list-style-type: none"> • Set the antenna switch in set mode to "Auto" or "Manual." 	<p>p. 10-4</p>
Transmitting is impossible.	<ul style="list-style-type: none"> • The operating frequency is not inside a ham band. 	<ul style="list-style-type: none"> • Set the frequency to be in a ham band. 	<p>p. 3-5</p>
Output power is too low.	<ul style="list-style-type: none"> • [RF PWR] is set too far counterclockwise • [DRIVE] is set too far counterclockwise • [MIC] is set too far counterclockwise • The antenna for another band is selected. • The antenna is not properly tuned. 	<ul style="list-style-type: none"> • Rotate [RF PWR] clockwise. • Set [DRIVE] to a suitable position. • Set [MIC] to a suitable position. • Select an antenna suitable for the operating frequency. • Push and hold [TUNER] for 1 sec. to manually tune the antenna. 	<p>p. 3-12 p. 3-13 p. 3-12 p. 10-2 p. 10-6</p>
No contact possible with another station.	<ul style="list-style-type: none"> • RIT or ΔTX function is activated. • Split frequency function is activated. 	<ul style="list-style-type: none"> • Push [RIT] or [ΔTX] to turn the function OFF. • Push [SPLIT] to turn the function OFF. 	<p>pgs. 5-10, 6-4 p. 6-6</p>
Transmit signal is unclear or distorted.	<ul style="list-style-type: none"> • [MIC] is set too far clockwise 	<ul style="list-style-type: none"> • Set [MIC] to a suitable position. 	<p>p. 3-12</p>
Repeater cannot be accessed.	<ul style="list-style-type: none"> • Split frequency function is not activated. • Programmed subaudible tone frequency is wrong. 	<ul style="list-style-type: none"> • Push [SPLIT] to turn the function ON • Reset the frequency using set mode. 	<p>p. 6-6 p. 4-33</p>

◇ Scanning

PROBLEM	POSSIBLE CAUSE	SOLUTION	REF.
Programmed scan does not stop.	• Squelch is open.	• Set [SQL] to the threshold point.	p. 3-9
Programmed scan does not start.	• The same frequencies have been programmed in scan edge memory channels P1 and P2.	• Program different frequencies in scan edge memory channel P1 and P2.	p. 8-3
Memory scan does not start	• 2 or more memory channels have not been programmed.	• Program more than 2 memory channels.	p. 8-3
Select memory scan does not start	• 2 or more memory channels have not been designated as select channels.	• Designate more than 2 memory channels as select channels for the scan.	p. 9-7

◇ Display

PROBLEM	POSSIBLE CAUSE	SOLUTION	REF.
The displayed frequency does not change properly.	• The dial lock function is activated. • A set mode screen is selected. • The internal CPU has malfunctioned.	• Push [LOCK] to turn the function OFF. • Push [EXIT/SET] several times to exit the set mode screen. • Reset the CPU.	p. 5-17 p. 12-2 p. 13-7

◇ Format USB-Memory

PROBLEM	POSSIBLE CAUSE	SOLUTION	REF.
Format error appears when formatting in FAT32	• The inserted USB-Memory capacity is smaller than 64 MB.	• Insert a USB-Memory larger than 64 MB or select the FAT format.	p. 12-26
Format error appears when formatting in FAT	• The inserted USB-Memory capacity is larger than 2 GB.	• Insert a USB-Memory smaller than 2 GB or select the FAT32 format.	p. 12-26

■ Main dial brake adjustment

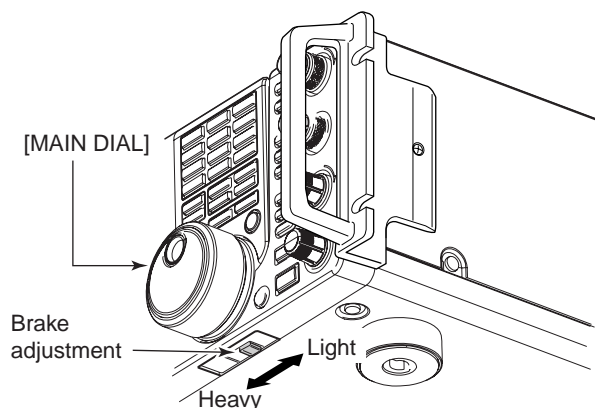

The tension of the main dial may be adjusted to suit your preference.

The brake adjustment is located on the bottom side of the front panel. See the figure at left.

Slide the brake adjustment to a comfortable tension level while turning the dial continuously and evenly in one direction.

SWR reading

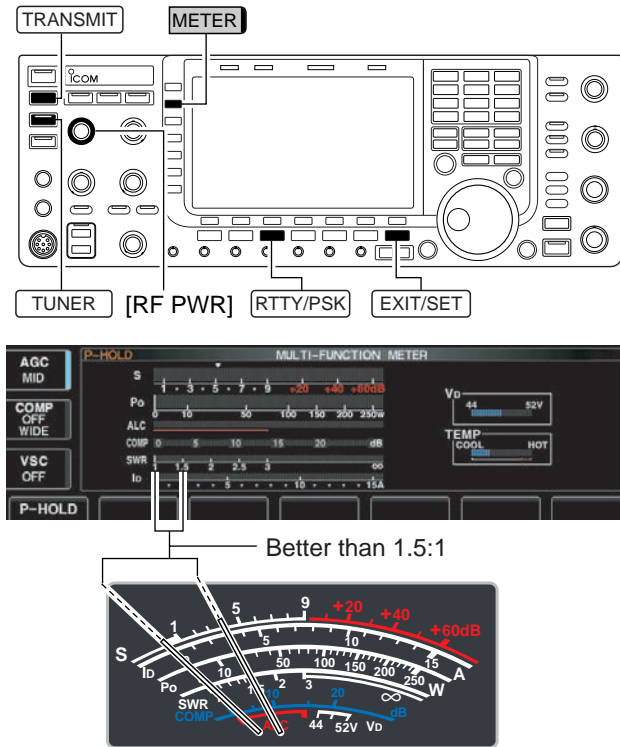

The SWR meter indicates the SWR over the transmission line in all modes.

- ① Push **[TUNER]** to turn the antenna tuner OFF.
- ② Push and hold **[METER]** for 1 sec. to display multi-function meter.
- ③ Push **[RTTY/PSK]** once or twice to select RTTY mode.
- ④ Push **[TRANSMIT]**.
- ⑤ Rotate **[RF PWR]** clockwise past the 12 o'clock position for more than 30 W output power.
- ⑥ Read the SWR on the SWR meter gage.
- ⑦ Push **[EXIT/SET]** to close multi-function meter.

▨ The built-in antenna tuner matches the transmitter to the antenna when the SWR is lower than 3 : 1.

Screen type and font selections

• Screen image example—
Display Type: B, Display Font: Slim



2 types of screen images and 5 types of frequency readout indication fonts are available in the IC-7700.

- ① Push **[EXIT/SET]** several times to close multi-function screen, if necessary.
- ② Push **[F-7•SET]** to select set mode menu screen.
- ③ Push **[F-3•DISP]** to enter display set mode.
- ④ Push **[F-1•▲]** or **[F-2•▼]** to select “Display Type” item when selecting the screen image, select “Display Font” when selecting the frequency readout indication font.
- ⑤ Rotate the main dial to select the desired screen image or font.
 - Screen image is selectable from A (Black back) and B (Blue back).
 - Basic (1), Basic(2), Italic, Round and Slim are available for the frequency readout font.
- ⑥ Push **[EXIT/SET]** twice to exit from display set mode.

Frequency calibration (approximate)

A very accurate frequency counter is required to calibrate the frequency of the transceiver. However, a rough check may be performed by receiving radio station WWV, WWVH, or other standard frequency signals.

CAUTION: The IC-7700 has been thoroughly adjusted and tested at the factory before being shipped. You should not have to re-calibrate it.

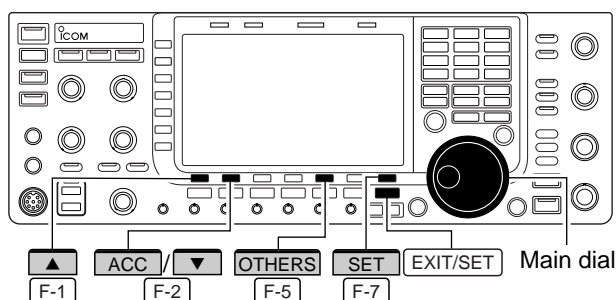

Calibration marker item



REF Adjust item



- ① Push **[SSB]** to select USB mode.
- ② Push and hold **[PBT-CLR]** for 1 sec. to clear the PBT setting and make sure that the RIT/ Δ TX function is not activated.
- ③ Set the frequency to the standard frequency station minus 1 kHz.
 - When receiving WWV or WWVH (at 15.00000 MHz) as a standard frequency, set the operating frequency for 14.99900 MHz.
 - Other standard frequencies can be used.
- ④ Push **[EXIT/SET]** several times to close a multi-function screen, if necessary.
- ⑤ Push **[F-7•SET]** to select set mode menu screen.
- ⑥ Push **[F-5•OTHERS]** to enter Others set mode.
- ⑦ Push **[F-1•▲]** several times to select the “Calibration Marker” item.
- ⑧ Rotate the main dial clockwise to turn the calibration marker ON.
- ⑨ Push **[EXIT/SET]** once to return to set mode menu screen.
- ⑩ Push **[F-2•ACC]** to enter accessory set mode.
- ⑪ Push **[F-2•▼]** several times to select the “REF Adjust” item.
- ⑫ Rotate the main dial to adjust for a zero beat with the received standard signal as shown at left.
 - Zero beat means that two signals are exactly the same frequency, resulting in a single tone being emitted.
- ⑬ Turn the calibration marker OFF in Others set mode.
- ⑭ Push **[EXIT/SET]** twice to exit set mode.

■ Opening the transceiver's case

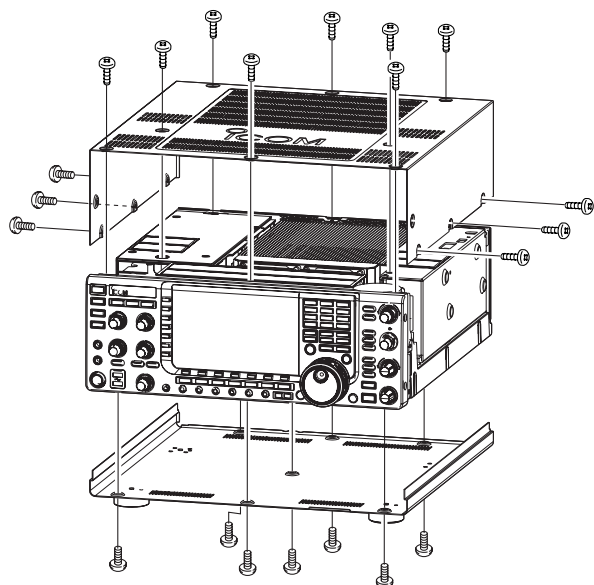

Follow the case opening procedures shown here when you want to replace the clock backup battery or internal fuse.

CAUTION! DISCONNECT the AC power cable from the transceiver before performing any work on the transceiver. Otherwise, there is danger of electric shock and/or equipment damage.

CAUTION! The transceiver weighs approx. 24 kg (53 lb). Always have two people available to lift or turn over the transceiver.

- ① Remove the rack mounting handle from both side. See p. 2-3 for rack mounting handle detachment details.
- ② Remove the 8 screws from the top of the transceiver and the 6 screws from the sides, then lift up the top cover.
- ③ Turn the transceiver upside-down.

CAUTION: NEVER HOLD THE MAIN DIAL OR ANY OTHER KNOBS when the transceiver is being turned upside down. This may damage the transceiver.

- ④ Remove 7 screws from the bottom, then lift up the bottom cover.

■ Clock backup battery replacement

The IC-7700 has a lithium backup battery (CR2032) inside for clock and timer functions. The usual life of the backup battery is approximately 2 years.

When the backup battery is discharged, the transceiver transmits and receives normally but cannot retain the current time.

WARNING: DISCONNECT the AC power cable from the AC outlet before removing the transceiver's cover.

- ① Remove the top cover as shown above.
- ② Replace the clock backup battery, located on the front panel as illustrated at left.
 - Make sure the battery polarity is correct.
- ③ Return the top cover to the original position.
- ④ Set the date and time in time set mode. (p. 11-2)

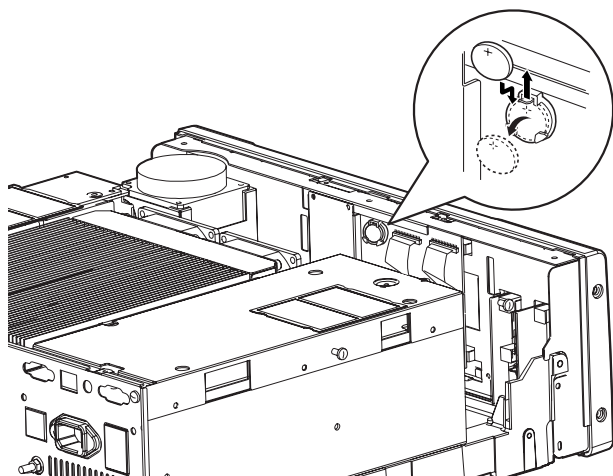

■ Fuse replacement

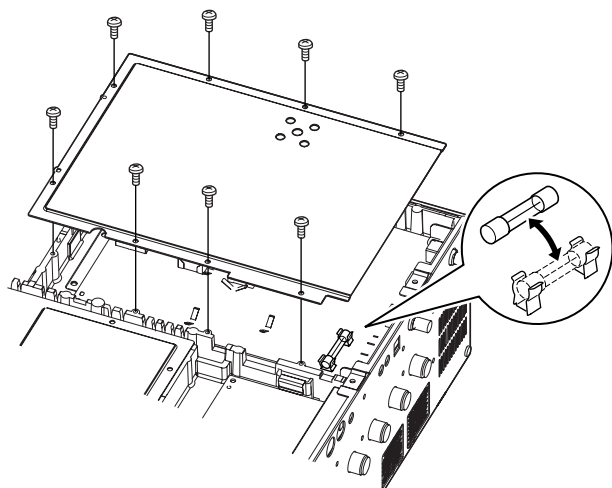

When no external DC output is available from [EXT DC] and ACC connectors, the internal fuse may be open. Replace the fuse in this case.

WARNING: DISCONNECT the AC power cable from the AC outlet before removing the transceiver's cover.

- ① Remove the bottom cover as shown left.
- ② Remove the 8 screws from the shield cover of the transceiver's bottom side.
- ③ Replace the open fuse with a new, properly rated one (FGB 2 A) as shown at left.
- ④ Return the inside cover and bottom cover and screws to the original position.

■ Resetting the CPU

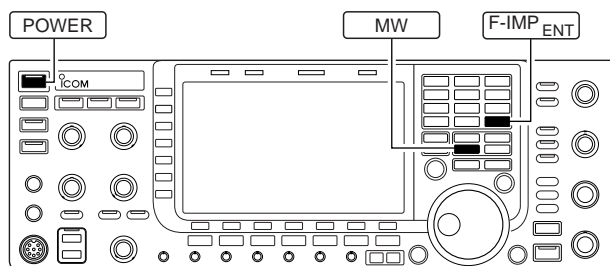

- ① Turn the main power switch on the rear panel ON.
 - Make sure the transceiver power is still OFF.
- ② While pushing and holding [F-IMP ENT] and [MW], push [POWER] to turn power ON.
 - The internal CPU is reset.
 - The CPU start-up takes approx. 5 sec.
 - The transceiver displays its initial VFO frequencies when resetting is complete.
- ③ Correct the set mode settings after resetting, if desired.

NOTE: Resetting **CLEARs** all programmed contents in memory channels and returns programmed values in set mode to default values.

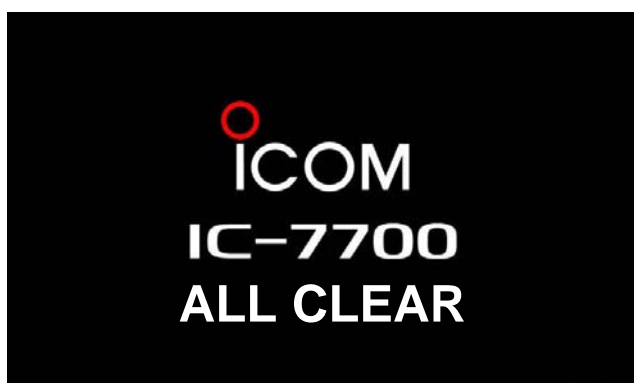

About protection indications

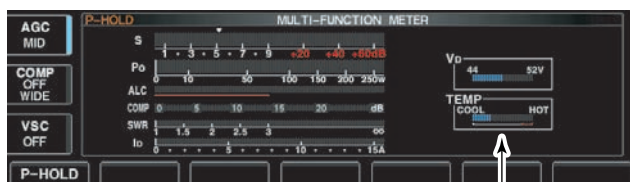

Check the temperature

The IC-7700 has a 2-step protection function to protect the final power amplifiers.

The protector monitors the power amplifier temperature and activates when the temperature becomes extremely high.

- **Power down transmission**

Reduces the transmit output power to 100 W. “LMT” appears beside the transmit indicator during transmit.

- **Transmission inhibit**

Deactivates the transmitter. The transmit indicator is displayed in gray during transmit.

When the protector is activated, wait until the power amplifier cools down using the transceiver in standby or receive condition.

NOTE: DO NOT turn the transceiver power OFF when the protector is ON. If you do, the cooling fan will not function and it will take longer to cool the transceiver.

The power amplifier temperature can be monitored in the multi-function meter, TEMP gauge.

Screen saver function

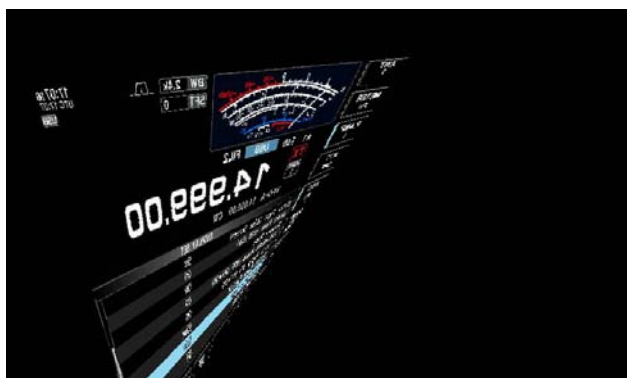
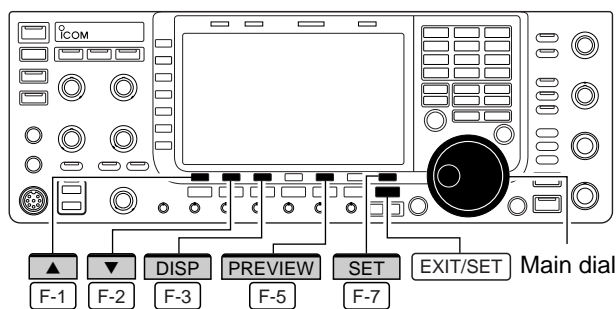

The IC-7700 has a screen saver function to protect the LCD from the “burn-in” effect.

- ① Push [EXIT/SET] several times to close a multi-function screen, if necessary.
- ② Push [F-7•SET] to select set mode menu screen.
- ③ Push [F-3•DISP] to enter display set mode.
- ④ Push [F-1•▲]/[F-2•▼] several times to select the “Screen Saver Function” item.
- ⑤ Rotate the main dial to select the desired time period for the screen saver activation from 15, 30, 60 min. and OFF.
 - Deactivate the screen saver with “OFF” selection.
- ⑥ Push [F-2•▼] to select the “Screen Saver Type” item.
- ⑦ Rotate the main dial to select the screen saver type from “Bound,” “Rotation” and “Twist.”
 - Push and hold [F-5•PREVIEW] to display the indication for your reference.
- ⑧ Push [EXIT/SET] twice to exit set mode.

**Downloaded by
RadioAmateur.EU**

- Remote jack (CI-V) information 14-2
 - ◇ CI-V connection example 14-2
 - ◇ Data format 14-2
 - ◇ Command table 14-3
 - ◇ To send/read memory contents 14-9
 - ◇ Band stacking register 14-9
 - ◇ Codes for memory keyer contents 14-9
 - ◇ Codes for memory name, opening message
and CLOCK2 name contents 14-9
 - ◇ Offset frequency setting 14-10
 - ◇ Repeater tone/tone squelch frequency setting 14-10
 - ◇ SSB transmission passband width setting 14-10
 - ◇ Color setting 14-10
 - ◇ Bandscope edge frequency setting 14-10
 - ◇ Data mode with filter width setting 14-10
 - ◇ Antenna memory setting 14-10

Remote jack (CI-V) information

CI-V connection example

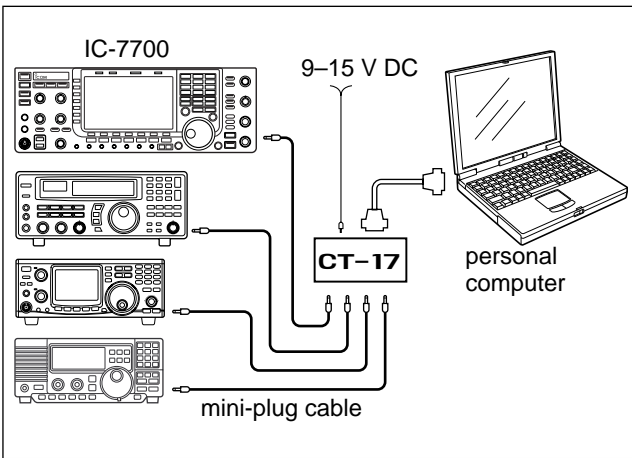

The transceiver can be connected through an optional CT-17 CI-V LEVEL CONVERTER to a PC equipped with an RS-232C port. The Icom Communications Interface-V (CI-V) controls the transceiver.

Up to 4 Icom CI-V transceivers or receivers can be connected to a PC equipped with an RS-232C port. See p. 12-17 for setting the CI-V condition using set mode.

Data format

The CI-V system can be operated using the following data formats. Data formats differ according to command numbers. A data area or sub command is added for some commands.

Controller to IC-7700

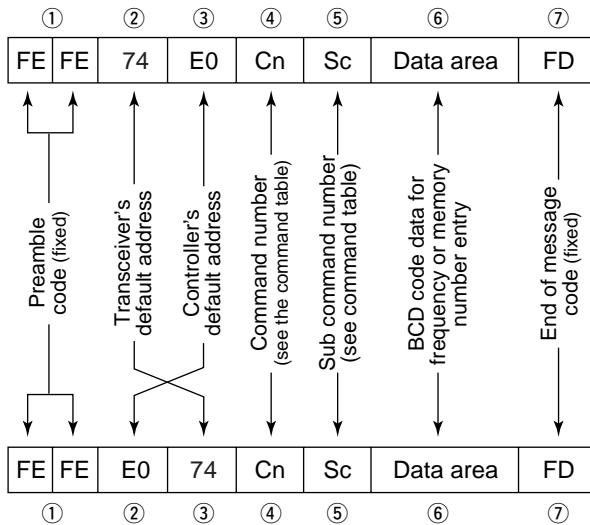

IC-7700 to controller

OK message to controller

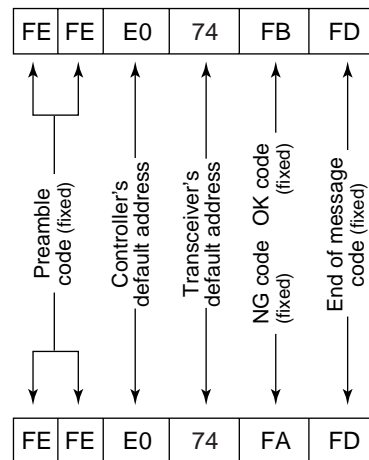

NG message to controller

◆ Command table

Command	Sub command	Description	Command	Sub command	Description
00	—	Send frequency data	11	—	Select/read attenuator (0=OFF; 1=6 dB; 2=12 dB; 3=18 dB)
01	Same as command 06	Send mode data	12	00 + RX ANT	Select/read ANT1 selection (00=RX ANT OFF; 01=RX ANT ON)
02	—	Read band edge frequencies		01 + RX ANT	Select/read ANT2 selection (00=RX ANT OFF; 01=RX ANT ON)
03	—	Read operating frequency		02 + RX ANT	Select/read ANT3 selection (00=RX ANT OFF; 01=RX ANT ON)
04	—	Read operating mode		03 + RX ANT	Select/read ANT4 selection (00=RX ANT OFF; 01=RX ANT ON)
05	—	Set operating frequency	13	00	Announce with voice synthesizer (00=all data; 01=frequency and S-meter level; 02=receive mode)
06	00	Select LSB		01	
	01	Select USB		02	
	02	Select AM	14	01 + Level data	[AF] level setting (0=max. CCW to 255=max. CW)
	03	Select CW		02 + Level data	[RF] level setting (0=max. CCW to 255=11 o'clock)
	04	Select RTTY		03 + Level data	[SQL] level setting (0=11 o'clock to 255=max. CW)
	05	Select FM		05 + Level data	[APF] level setting (0=Pitch-550 Hz, 128=Pitch, 255=Pitch+550 Hz; 10 Hz steps)
	07	Select CW-R		06 + Level data	[NR] level setting (0=min. to 255=max.)
	08	Select RTTY-R		07 + Level data	Inside [TWIN PBT] setting or IF shift setting (0=max. CCW, 128=center, 255=max. CW)
12	Select PSK	08 + Level data		Outside [TWIN PBT] setting (0=max. CCW, 128=center, 255=max. CW)	
13	Select PSK-R	09 + Level data		[CW PITCH] setting (0=300 Hz, 128=600 Hz, 255=900 Hz; 5 Hz steps)	
07	—	Select VFO mode	0A + Level data	[RF POWER] setting (0=max. CCW to 255=max. CW)	
	00	Select VFO-A	0B + Level data	[MIC] setting (0=max. CCW to 255=max. CW)	
	01	Select VFO-B	0C + Level data	[KEY SPEED] setting (0=max. CCW to 255=max. CW)	
	A0	Equalize VFO-A and VFO-B	0D + Level data	[NOTCH] setting (0=low freq. to 255=high freq.)	
	B0	Exchange VFO-A and VFO-B	0E + Level data	[COMP] setting (0=max. CCW to 255=max. CW)	
08	—	Select memory mode	0F + Level data	[DELAY] setting (0=max. CCW to 255=max. CW)	
	0001-0101*	Select memory channel *P1=0100, P2=0101	11 + Level data	[AGC] control setting (0=max. CCW to 255=max. CW)	
09	—	Memory write	12 + Level data	[NB] control setting (0=max. CCW to 255=max. CW)	
0A	—	Memory to VFO	13 + Level data	[DIGI-SEL] setting (0=max. CCW to 255=max. CW)	
0B	—	Memory clear	14 + Level data	[DRIVE] setting (0=max. CCW to 255=max. CW)	
0E	00	Scan stop	15 + Level data	[MONI GAIN] setting (0=max. CCW to 255=max. CW)	
	01	Programmed/memory scan start	16 + Level data	[VOX GAIN] setting (0=max. CCW to 255=max. CW)	
	02	Programmed scan start	17 + Level data	[ANTI VOX] setting (0=max. CCW to 255=max. CW)	
	03	Δ F scan start			
	12	Fine programmed scan start			
	13	Fine Δ F scan start			
	22	Memory scan start			
	23	Select memory scan start			
	A1-A7	Set Δ F scan span (A1= \pm 5 kHz; A2= \pm 10 kHz; A3= \pm 20 kHz; A4= \pm 50 kHz; A5= \pm 100 kHz; A6= \pm 500 kHz; A7= \pm 1 MHz)			
	B0	Set as non-select channel			
	B1	Set as select channel (1=★1; 2=★2; 3=★3; when no data command is specified, the previously set number or "★1" is selected)			
B2	Set the number for select memory scan (0=ALL; 1=★1; 2=★2; 3=★3)				
D0	Set scan resume OFF				
D3	Set scan resume ON				
0F	00	Turn the split function OFF			
	01	Turn the split function ON			
10	00	Select 10 Hz (1 Hz) tuning step			
	01	Select 100 Hz tuning step			
	02	Select 1 kHz tuning step			
	03	Select 5 kHz tuning step			
	04	Select 9 kHz tuning step			
	05	Select 10 kHz tuning step			
	06	Select 12.5 kHz tuning step			
	07	Select 20 kHz tuning step			
	08	Select 25 kHz tuning step			

14 CONTROL COMMAND

◇ Command table (continued)

Command	Sub command	Description
14	18 + Level data	[CONTRAST] setting (0=max. CCW to 255=max. CW)
	19 + Level data	[BRIGHT] setting (0=max. CCW to 255=max. CW)
15	01	Read squelch condition
	02	Read S-meter level
	11	Read RF power meter
	12	Read SWR meter
	13	Read ALC meter
	14	Read COMP meter
	15	Read V _D meter
16	Read Id meter	
16	02	Send/read Preamp setting (0=OFF; 1=preamp 1; 2=preamp 2)
	12	Send/read AGC selection (0=OFF; 1=Slow; 2=Mid; 3=Fast)
	22	Send/read noise blanker setting (0=OFF; 1=ON)
	32	Send/read Audio peak filter setting for CW mode (APF type=SHARP: 0=OFF; 1=320 Hz; 2=160 Hz; 3=80 Hz, APF type=SOFT: 0=OFF; 1=WIDE; 2=MID; 3=NAR)
	40	Send/read noise reduction setting (0=OFF; 1=ON)
	41	Send/read auto notch setting (0=OFF; 1=ON)
	42	Send/read repeater tone setting (0=OFF; 1=ON)
	43	Send/read tone squelch setting (0=OFF; 1=ON)
	44	Send/read speech compressor setting (0=OFF; 1=ON)
	45	Send/read monitor setting (0=OFF; 1=ON)
	46	Send/read VOX function setting (0=OFF; 1=ON)
	47	Send/read Break-in function setting (0=OFF; 1=semi break-in; 2=full break-in)
	48	Send/read manual notch setting (0=OFF; 1=ON)
	4C	Send/read VSC setting (0=OFF; 1=ON)
	4D	Send/read Manual AGC setting (0=OFF; 1=ON)
	4E	Send/read DIGI-SEL setting (0=OFF; 1=ON)
	4F	Send/read twin peak filter setting (0=OFF; 1=ON)
50	Send/read dial lock function setting (0=OFF; 1=ON)	
53	Send/read RX antenna connector setting (0=OFF; 1=ON)	
19	00	Read the transceiver ID
1A	00	Send/read memory contents (see p. 14-9 for details)
	01	Send/read band stacking register contents (see p. 14-9 for details)
	02	Send/read memory keyer contents (see p. 14-9 for details)

Command	Sub command	Description
1A	03	Send/read the selected filter width (SSB, CW, PSK: 0=50 Hz to 40=3600 Hz; RTTY: 0=50 Hz to 31=2700 Hz; AM: 0=200 Hz to 49=10 kHz)
	04	Send/read the selected AGC time constant (0=OFF, 1=0.1/0.3 sec. to 13=6.0/8.0 sec.)
	050001	Send/read SSB RX HPF/LPF (HPF: 0=Through, 1=100 to 20=2000, LPF: 5=500 to 24=2400, 25=Through)
	050002	Send/read SSB RX Tone (Bass) level (0=-5 to 10=+5)
	050003	Send/read SSB RX Tone (Treble) level (0=-5 to 10=+5)
	050004	Send/read AM RX HPF/LPF (HPF: 0=Through, 1=100 to 20=2000, LPF: 5=500 to 24=2400, 25=Through)
	050005	Send/read AM RX Tone (Bass) level (0=-5 to 10=+5)
	050006	Send/read AM RX Tone (Treble) level (0=-5 to 10=+5)
	050007	Send/read FM RX HPF/LPF (HPF: 0=Through, 1=100 to 20=2000, LPF: 5=500 to 24=2400, 25=Through)
	050008	Send/read FM RX Tone (Bass) level (0=-5 to 10=+5)
	050009	Send/read FM RX Tone (Treble) level (0=-5 to 10=+5)
	050010	Send/read CW RX HPF/LPF (HPF: 0=Through, 1=100 to 20=2000, LPF: 5=500 to 24=2400, 25=Through)
	050011	Send/read RTTY RX HPF/LPF (HPF: 0=Through, 1=100 to 20=2000, LPF: 5=500 to 24=2400, 25=Through)
	050012	Send/read PSK RX HPF/LPF (HPF: 0=Through, 1=100 to 20=2000, LPF: 5=500 to 24=2400, 25=Through)
	050013	Send/read SSB TX Tone (Bass) level (0=-5 to 10=+5)
	050014	Send/read SSB TX Tone (Treble) level (0=-5 to 10=+5)
	050015	Send/read AM TX Tone (Bass) level (0=-5 to 10=+5)
	050016	Send/read AM TX Tone (Treble) level (0=-5 to 10=+5)
	050017	Send/read FM TX Tone (Bass) level (0=-5 to 10=+5)
	050018	Send/read FM TX Tone (Treble) level (0=-5 to 10=+5)
	050019	Send/read SSB TX bandwidth for wide (see p. 14-10 for details)
	050020	Send/read SSB TX bandwidth for mid. (see p. 14-10 for details)
050021	Send/read SSB TX bandwidth for narrow (see p. 14-10 for details)	
050022	Send/read speech level (0=0% to 255=100%)	

◆ Command table (continued)

Command	Sub command	Description	Command	Sub command	Description
1A	050023	Send/read CW side tone gain (0=min. to 255=max.)	1A	050049	Send/read memory name indication setting (0=OFF, 1=ON)
	050024	Send/read CW side tone gain limit (0=OFF, 1=ON)		050050	Send/read audio peak filter width pop-up indication setting (0=OFF, 1=ON)
	050025	Send/read beep gain (0=min. to 255=max.)		050051	Send/read manual notch width pop-up indication setting (0=OFF, 1=ON)
	050026	Send/read beep gain limit (0=OFF, 1=ON)		050052	Send/read screen saver set (0=OFF, 1=15 min., 2=30 min., 3=60 min.)
	050027	Send/read headphones output ratio (0=0.60 to 255=1.40)		050053	Set/read screen saver type (0=Bound, 1=Rotation, 2=Twist)
	050028	Send/read AF output level to ACC (0=0% to 255=100%)		050054	Send/read output signal setting for external display (0=OFF, 1=ON)
	050029	Send/read S/P DIF output level (0=0% to 255=100%)		050055	Send/read synchronous pulse level setting (0=L, 1=H)
	050030	Send/read MOD output level to ACC (0=0% to 255=100%)		050056	Send/read opening message indication (0=OFF, 1=ON)
	050031	Send/read S/P DIF MOD output level (0=0% to 255=100%)		050057	Send/read opening message contents (see p. 14-9 for details)
	050032	Send/read MOD input connector during DATA OFF (0=MIC; 1=ACC; 2=MIC/ACC; 3=S/P DIF)		050058	Send/read date (20000101=1st Jan. 2000 to 20991231=31st Dec. 2099)
	050033	Send/read MOD input connector during DATA1 (0=MIC; 1=ACC; 2=MIC/ACC; 3=S/P DIF)		050059	Send/read time (0000=00:00 to 2359=23:59)
	050034	Send/read MOD input connector during DATA2 (0=MIC; 1=ACC; 2=MIC/ACC; 3=S/P DIF)		050060	Send/read CLOCK2 function (0=OFF, 1=ON)
	050035	Send/read MOD input connector during DATA3 (0=MIC; 1=ACC; 2=MIC/ACC; 3=S/P DIF)		050061	Send/read offset time for CLOCK2 (240001=-24:00 to 240000=+24:00)
	050036	Send/read relay type selection (0=Lead, 1=MOS-FET)		050062	Send/read CLOCK2 name (up to 3-character; see p. 14-9)
	050037	Send/read external meter output selection (0=Auto, 1=S, 2=Po, 3=SWR, 4=ALC, 5=COMP, 6=Vd, 7=Id)		050063	Send/read calibration marker (0=OFF, 1=ON)
	050038	Send/read external meter output level (0=0% to 255=100%)		050064	Send/read confirmation beep (0=OFF, 1=ON)
	050039	Send/read reference signal in/out setting (0=OFF, 1=IN, 2=OUT)		050065	Send/read band edge beep (0=OFF, 1=ON)
	050040	Send/read reference signal frequency setting (0=0% to 255=100%)		050066	Send/read beep audio frequency (50=500 Hz to 200=2000 Hz)
	050041	Send/read LCD unit backlight brightness (0=0% to 255=100%)		050067	Send/read quick split set (0=OFF, 1=ON)
	050042	Send/read switch indicator brightness (0=0% to 255=100%)		050068	Send/read FM split offset -9.999 to +9.999 MHz for HF (see p. 14-10 for details)
	050043	Send/read screen image type (0=A, 1=B)		050069	Send/read FM split offset -9.999 to +9.999 MHz for 50 MHz (see p. 14-10 for details)
	050044	Send/read frequency readout font (0=Basic (1), 1=Basic (2), 2=Italic, 3=Round, 4=Slim)		050070	Send/read split lock set (0=OFF, 1=ON)
	050045	Send/read meter response setting (0=SLOW, 1=MID, 2=FAST)		050071	Send/read tuner auto start set (0=OFF, 1=ON)
	050046	Send/read meter type (0=Standard, 1=Edgewise, 2=Bar)		050072	Send/read PTT tune set (0=OFF, 1=ON)
	050047	Send/read meter type during wide screen or mini scope indication (0=Edgewise, 1=Bar)		050073	Send/read transverter set (0=OFF, 1=ON)
	050048	Send/read peak hold set for Bar meter (0=OFF, 1=ON)		050074	Send/read transverter offset (see p. 14-10 for details)
				050075	Send/read RTTY mark frequency (0=1275 Hz, 1=1615 Hz, 2=2125 Hz)
				050076	Send/read RTTY shift width (0=170 Hz, 1=200 Hz, 2=425 Hz)

◇ Command table (continued)

Command	Sub command	Description
1A	050077	Send/read RTTY keying polarity (0=Normal, 1=Reverse)
	050078	Send/read PSK tone frequency (0=1000 Hz, 1=1500 Hz, 2=2000 Hz)
	050079	Send/read speech language (0=English, 1=Japanese)
	050080	Send/read speech speed (0=Slow, 1=Fast)
	050081	Send/read S-level speech (0=OFF, 1=ON)
	050082	Send/read speech with a mode switch operation (0=OFF, 1=ON)
	050083	Send/read memo pad numbers (0=5 ch, 1=10 ch)
	050084	Send/read main dial auto TS (0=OFF, 1=Low, 2=High)
	050085	Send/read mic. up/down speed (0=Low, 1=High)
	050086	Send/read quick RIT/ Δ TX clear function (0=OFF, 1=ON)
	050087	Send/read SSB notch operation (0=Auto, 1=Manual, 2=Auto/Manual)
	050088	Send/read AM notch operation (0=Auto, 1=Manual, 2=Auto/Manual)
	050089	Send/read DIGI-SEL control function (0=DIGI-SEL, 1=APF)
	050090	Send/read SSB/CW synchronous tuning function (0=OFF, 1=ON)
	050091	Send/read CW normal side set (0=LSB, 1=USB)
	050192	Set/read APF type (0=SHARP, 1=SOFT)
	050093	Send/read external keypad set for voice memory (0=OFF, 1=ON)
	050094	Send/read external keypad set for keyer memory (0=OFF, 1=ON)
	050095	Send/read CI-V transceiver set (0=OFF, 1=ON)
	050096	Send/read RS-232C function (0=CI-V, 1=Decode)
050097	Send/read RS-232C decode Baud rate (0=300, 1=1200, 2=4800, 3=9600, 4=19200)	
050098	Send/read keyboard type (00=English, 01=Japanese, 02=United Kingdom, 03=French, 04=French (Canadian), 05=German, 06=Portuguese, 07=Portuguese (Brazilian), 08=Spanish, 09=Spanish (Latin American), 10=Italian)	
050099	Send/read keyboard repeat delay (10=100 msec. to 100=1000 msec.)	
050100	Send/read keyboard repeat rate (0=2.0 cps to 31=30.0 cps)	
050101	Send/read IP address set (000000000000001=0.0.0.1 to 0255025502550254=255.255.255.254)	

Command	Sub command	Description
1A	050102	Send/read subnet mask (1=128.0.0.0 to 30=255.255.255.252)
	050103	Send/read scope indication during TX (0=OFF, 1=ON)
	050104	Send/read scope max. hold (0=OFF, 1=ON)
	050105	Send/read scope center frequency set (0=Filter center, 1=Carrier point center, 2=Carrier point center (Abs. Freq.))
	050106	Send/read waveform color for receiving signal (see p. 14-10 for details)
	050107	Send/read waveform color for max. hold (see p. 14-10 for details)
	050108	Send/read scope sweep speed for ± 2.5 kHz span (0=Slow, 1=Mid., 2=Fast)
	050109	Send/read scope sweep speed for ± 5 kHz span (0=Slow, 1=Mid., 2=Fast)
	050110	Send/read scope sweep speed for ± 10 kHz span (0=Slow, 1=Mid., 2=Fast)
	050111	Send/read scope sweep speed for ± 25 kHz span (0=Slow, 1=Mid., 2=Fast)
	050112	Send/read scope sweep speed for ± 50 kHz span (0=Slow, 1=Mid., 2=Fast)
	050113	Send/read scope sweep speed for ± 100 kHz span (0=Slow, 1=Mid., 2=Fast)
	050114	Send/read scope sweep speed for ± 250 kHz span (0=Slow, 1=Mid., 2=Fast)
050115	Send/read scope edge frequencies for 0.03 to 1.60 MHz band (see p. 14-10 for details)	
050116	Send/read scope edge frequencies for 1.60 to 2.00 MHz band (see p. 14-10 for details)	
050117	Send/read scope edge frequencies for 2.00 to 6.00 MHz band (see p. 14-10 for details)	
050118	Send/read scope edge frequencies for 6.00 to 8.00 MHz band (see p. 14-10 for details)	
050119	Send/read scope edge frequencies for 8.00 to 11.00 MHz band (see p. 14-10 for details)	
050120	Send/read scope edge frequencies for 11.00 to 15.00 MHz band (see p. 14-10 for details)	
050121	Send/read scope edge frequencies for 15.00 to 20.00 MHz band (see p. 14-10 for details)	
050122	Send/read scope edge frequencies for 20.00 to 22.00 MHz band (see p. 14-10 for details)	
050123	Send/read scope edge frequencies for 22.00 to 26.00 MHz band (see p. 14-10 for details)	

◆ Command table (continued)

Command	Sub command	Description	Command	Sub command	Description
1A	050124	Send/read scope edge frequencies for 26.00 to 30.00 MHz band (see p. 14-10 for details)	1A	050151	Send/read time stamp text font color (see p. 14-10 for details)
	050125	Send/read scope edge frequencies for 30.00 to 45.00 MHz band (see p. 14-10 for details)		050152	Send/read text font color in TX buffer (see p. 14-10 for details)
	050126	Send/read scope edge frequencies for 45.00 to 60.00 MHz band (see p. 14-10 for details)		050153	Send/read FFT scope averaging set for PSK decoder (0=OFF, 1=2, 2=3, 3=4)
	050127	Send/read auto voice monitor set (0=OFF, 1=ON)		050154	Send/read FFT scope waveform color set for PSK decoder (see p. 14-10 for details)
	050128	Send/read voice memory short play time (3=3 sec. to 10=10 sec.)		050155	Send/read PSK AFC function tuning range (0=±8 Hz, 1=±15 Hz)
	050129	Send/read voice memory normal record time (5= 5 sec. to 15=15 sec.)		050156	Send/read PSK time stamp set (0=OFF, 1=ON)
	050130	Send/read contest number style (0=Normal, 1=190→ANO, 2=190→ANT, 3=90→NO, 4=90→NT)		050157	Send/read clock selection for time stamp (0=Local time, 1=CLOCK2)
	050131	Send/read count up trigger channel (1=M1, 2=M2, 3=M3, 4=M4)		050158	Send/read frequency stamp (0=OFF, 1=ON)
	050132	Send/read present number (1-9999)		050159	Send/read received text font color (see p. 14-10 for details)
	050133	Send/read CW keyer repeat time (1=1 sec. to 60=60 sec.)		050160	Send/read transmitted text font color (see p. 14-10 for details)
	050134	Send/read CW keyer dot/dash ratio (28=1:1:2.8 to 45=1:1:4.5)		050161	Send/read time stamp text font color (see p. 14-10 for details)
	050135	Send/read rise time (0=2 msec., 1=4 msec., 2=6 msec., 3=8 msec.)		050162	Send/read text font color in TX buffer (see p. 14-10 for details)
	050136	Send/read paddle polarity (0=Normal, 1=Reverse)		050163	Send/read scan speed (0=Low, 1=High)
	050137	Send/read keyer type (0=Straight, 1=Bug-key, 2=ELEC-Key)		050164	Send/read scan resume (0=OFF, 1=ON)
	050138	Send/read mic. up/down keyer set (0=OFF, 1=ON)		050165	Send/read antenna selection for 0.03 to 1.60 MHz band (see p. 14-10 for details)
	050139	Send/read FFT scope averaging set for RTTY decoder (0=OFF, 1=2, 2=3, 3=4)		050166	Send/read antenna selection for 1.60 to 2.00 MHz band (see p. 14-10 for details)
	050140	Send/read FFT scope waveform color set for RTTY decoder (see p. 14-10 for details)		050167	Send/read antenna selection for 2.00 to 6.00 MHz band (see p. 14-10 for details)
	050141	Send/read RTTY decode USOS (0=OFF, 1=ON)		050168	Send/read antenna selection for 6.00 to 8.00 MHz band (see p. 14-10 for details)
	050142	Send/read RTTY decode new line code (0=CR,LF,CR+LF, 1=CR+LF)		050169	Send/read antenna selection for 8.00 to 11.00 MHz band (see p. 14-10 for details)
	050143	Send/read RTTY diddle (0=OFF, 1=Blank, 2=LTRS (Letter code))		050170	Send/read antenna selection for 11.00 to 15.00 MHz band (see p. 14-10 for details)
	050144	Send/read RTTY TX USOS (0=OFF, 1=ON)		050171	Send/read antenna selection for 15.00 to 20.00 MHz band (see p. 14-10 for details)
	050145	Send/read RTTY auto CR+LF by TX (0=OFF, 1=ON)		050172	Send/read antenna selection for 20.00 to 22.00 MHz band (see p. 14-10 for details)
	050146	Send/read RTTY time stamp set (0=OFF, 1=ON)		050173	Send/read antenna selection for 22.00 to 26.00 MHz band (see p. 14-10 for details)
	050147	Send/read clock selection for time stamp (0=Local time, 1=CLOCK2)		050174	Send/read antenna selection for 26.00 to 30.00 MHz band (see p. 14-10 for details)
	050148	Send/read frequency stamp (0=OFF, 1=ON)		050175	Send/read antenna selection for 30.00 to 45.00 MHz band (see p. 14-10 for details)
	050149	Send/read received text font color (see p. 14-10 for details)			
	050150	Send/read transmitted text font color (see p. 14-10 for details)			

14 CONTROL COMMAND

◇ Command table (continued)

Command	Sub command	Description
1A	050176	Send/read antenna selection for 45.00 to 60.00 MHz band (see p. 14-10 for details)
	050177	Send/read antenna temporary memory set (0=OFF, 1=ON)
	050178	Send/read antenna selection (0=OFF, 1=Manual, 2=Auto)
	050179	Send/read usage for ANT2 (0=OFF, 1=TX/RX)
	050180	Send/read usage for ANT3 (0=OFF, 1=TX/RX)
	050181	Send/read usage for ANT4 (0=OFF, 1=TX/RX, 2= RX)
	050182	Send/read VOX delay (0=0.0 sec. to 20=2.0 sec.)
	050183	Send/read VOX voice delay (0=OFF, 1=Short, 2=Mid., 3=Long)
	050184	Send/read NB depth (0=1 to 9=10)
	050185	Send/read NB width (0=0 to 255=255)
06	06	Send/read DATA mode with filter set (see p. 14-10 for detail)
	07	Send/read SSB transmit bandwidth (0=WIDE, 1=MID, 2=NAR)
	08	Send/read DSP filter shape (0= Sharp, 1= Soft)
	09	Send/read roofing filter set (0=3 kHz, 1=6 kHz, 2=15 kHz)
	0A	Send/read manual notch width (0=Wide, 1=Mid., 2=Nar.)
1B	00	Send/read repeater tone frequency (see p. 14-10 for details)
	01	Set/read TSQL tone frequency (see p. 14-10 for details)
1C	00	Send/read the transceiver's condition (0=Rx; 1=Tx)
	01	Send/read antenna tuner condition (0=OFF, 1=ON, 2=Start tuning or while tuning)

◇ To send/read memory contents

When sending or reading memory contents, additional codes must be added to append the memory channel as follows.

➔ Additional code: 0000–0101 (0100=P1, 0101=P2)

◇ Band stacking register

To send or read the desired band stacking register's contents, combined codes of the frequency band and register codes as follows are used.

For example, when sending/reading the oldest contents in the 21 MHz band, the code "0703" is used.

• Frequency band code

Code	Frequency band	Frequency range (unit: MHz)
01	1.8	1.800000– 1.999999
02	3.5	3.400000– 4.099999
03	7	6.900000– 7.499999
04	10	9.900000–10.499999
05	14	13.900000–14.499999
06	18	17.900000–18.499999
07	21	20.900000–21.499999
08	24	24.400000–25.099999
09	28	28.000000–29.999999
10	50	50.000000–54.000000
12	GENE	Other than above

• Register code

Code	Registered number
01	1 (latest)
02	2
03	3 (oldest)

◇ Codes for memory keyer contents

To send or read the desired memory keyer contents, the channel and character codes as follows are used.

• Channel code

Code	Channel number
01	M1
02	M2
03	M3
04	M4

• Character's code

Character	ASCII code	Description
0–9	30–39	Numerals
A–Z	41–5A	Alphabetical characters
space	20	Word space
/	2F	Symbol
?	3F	Symbol
,	2C	Symbol
.	2E	Symbol
^	5E	e.g., to send \bar{B} , enter ^4254
*	2A	Inserts contest number (can be used for 1 channel only)

◇ Codes for memory name, opening message and CLOCK2 name contents

To send or read the desired memory name settings, the character codes, instructed codes for memory keyer contents as above, and follows are used.

• Character's code— Alphabetical characters

Character	ASCII code	Character	ASCII code
a–z	61–7A	—	—

• Character's code— Symbols

Character	ASCII code	Character	ASCII code
!	21	#	23
\$	24	%	25
&	26	¥	5C
?	3F	"	22
'	27	`	60
+	2B	–	2D
:	3A	;	3B
=	3D	<	3C
>	3E	(28
)	29	[5B
]	5D	{	7B
}	7D		7C
_	5F	–	7E
@	40		

14 CONTROL COMMAND

◆ Offset frequency setting

The following data sequence is used when sending or reading the offset frequency setting.

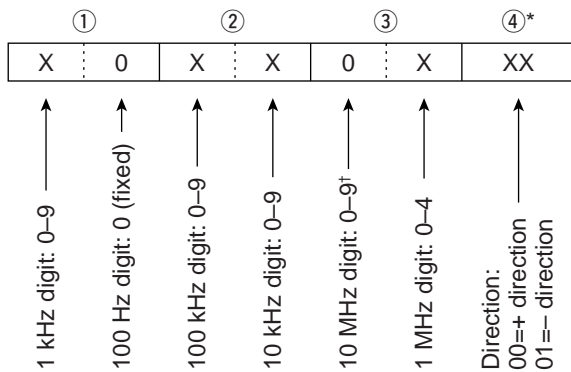

*No need to enter for transverter offset frequency setting.
 †Transverter offset only; Fix to '0' for split offset setting.

◆ Repeater tone/tone squelch frequency setting

The following data sequence is used when sending or reading the tone frequency setting.

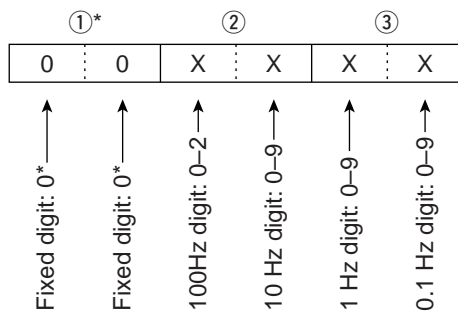

*Not necessary when setting a frequency.

◆ SSB transmission passband width setting

The following data sequence is used when sending or reading the SSB transmission passband width setting.

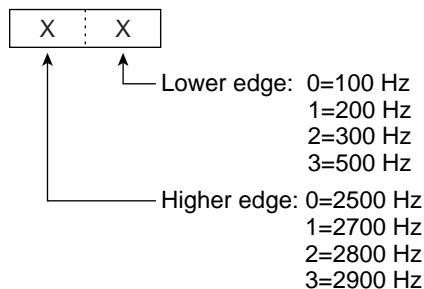

◆ Color setting

The following data sequence is used when sending or reading the color setting.

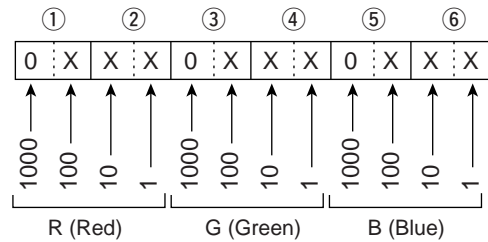

Using 0000-0255 for each color element.

◆ Bandscope edge frequency setting

The following data sequence is used when sending or reading the bandscope edge frequency setting.

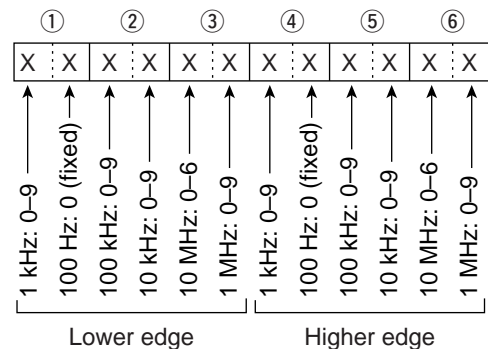

◆ Data mode with filter width setting

The following data sequence is used when sending or reading the data mode with filter width setting.

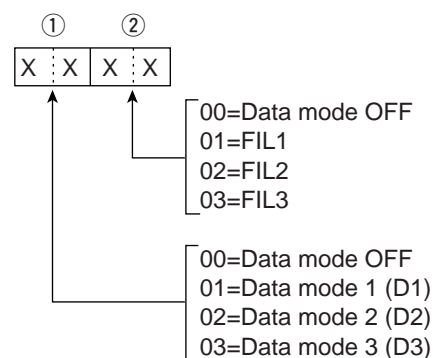

◆ Antenna memory setting

The following codes are used when sending or reading the antenna memory setting.

- 0=ANT1, 1=ANT2, 2=ANT3, 3=ANT4,
- 4*=TX: ANT1, RX: ANT4, 5*=TX: ANT2, RX: ANT4,
- 6*=TX: ANT3, RX: ANT4

*RX should be selected for ANT4

■ Specifications	15-2
◇ General	15-2
◇ Transmitter	15-2
◇ Receiver	15-3
◇ Antenna tuner	15-3
■ Options	15-4

■ Specifications

◇ General

- **Frequency coverage** (unit: MHz) :
 - Receiver : 0.030000–60.000000*¹
 - Transmitter : 1.800000–1.999999*², 3.500000–3.999999*²,
5.330500*³, 5.346500*³, 5.366500*³, 5.371500*³,
5.403500*³, 7.000000–7.300000*²,
10.100000–10.150000*², 14.000000–14.350000*²,
18.068000–18.168000*², 21.000000–21.450000*²,
24.890000–24.990000*², 28.000000–29.700000*²,
50.000000–54.000000*²
- **Operating mode** : USB, LSB, CW, RTTY, PSK31, AM, FM
- **Number of memory channels** : 101 (99 regular, 2 scan edges)
- **Antenna connector** : SO-239×4 (antenna impedance: 50 Ω)
- **Operating temperature range** : 0°C to +50°C; +32°F to +122°F
- **Frequency stability** : Less than ±0.05 ppm (approx. 5 min. after from turn
the main power, [I/O], ON, 0–50°C; 32–122°F)
- **Frequency resolution** : 1 Hz
- **Power supply requirement** : 85–265 V AC (universal input)
- **Power consumption** :
 - Receive : 200 VA typical
 - Stand-by : 210 VA typical
 - Max. audio : 800 VA
 - Transmit at 200 W
- **Dimensions** (projections not included) : 425×149×437 mm; 16²³/₃₂×5⁷/₈×17⁷/₃₂ in
- **Weight** : Approx. 22.5 kg; 50 lb
- **ACC 1 connectors** : 8-pin DIN connector
- **ACC 2 connectors** : 7-pin DIN connector
- **Display*** : 7-inch (diagonal) TFT color LCD (800×480)
- **EXT-DISPLAY connector** : D-sub 15S
- **CI-V connector** : 2-conductor 3.5 (d) mm (1/8")
- **RS-232C connector** : D-sub 9-pin
- **USB connector** : USB (Universal Serial Bus)1.1/2.0×2

◇ Transmitter

- **Transmit output power** :
 - SSB, CW, RTTY, PSK31, FM : 5–200 W
 - AM : 5–50 W
- **Modulation system** :
 - SSB : P.S.N. modulation
 - AM : Low power modulation
 - FM : Phase modulation
- **Spurious emission** :
 - More than 60 dB (HF bands)
 - More than 70 dB (50 MHz band)
- **Carrier suppression** : More than 63 dB
- **Unwanted side-band suppression** : More than 80 dB
- **ΔTX variable range** : ±9.999 kHz
- **Microphone connector** : 8-pin connector (600 Ω)
- **ELEC-KEY connector** : 3-conductor 6.35 (d) mm (1/4")
- **KEY connector** : 3-conductor 6.35 (d) mm (1/4")
- **RELAY connector** : Phono (RCA)
- **ALC connector** : Phono (RCA)

◇ **Receiver**

- **Receive system** : Double conversion superheterodyne system
- **Intermediate frequencies** :
 - 1st 64.455 MHz
 - 2nd 36 kHz
- **Sensitivity (typical)** :
 - SSB, CW, RTTY (BW=2.4 kHz, 10 dB S/N)
 - 0.100000– 1.799999 MHz 0.5 μ V (pre-amp 1 ON)
 - 1.800000–29.990000 MHz 0.16 μ V (pre-amp 1 ON)
 - 50.000000–54.000000 MHz 0.13 μ V (pre-amp 2 ON)
 - AM (BW=6 kHz, 10 dB S/N)
 - 0.100000– 1.799999 MHz 6.3 μ V (pre-amp 1 ON)
 - 1.800000–29.990000 MHz 2 μ V (pre-amp 1 ON)
 - 50.000000–54.000000 MHz 1 μ V (pre-amp 2 ON)
 - FM (BW=15 kHz, 12 dB SINAD)
 - 28.000000–29.990000 MHz 0.5 μ V (pre-amp 1 ON)
 - 50.000000–54.000000 MHz 0.32 μ V (pre-amp 2 ON)
- **Internal Modulate Distortion (typical)** : Dynamic range 105 dB
(at 14.100 MHz, 100 kHz separation, pre-amp OFF, CW mode; BW=500 Hz)
- **Selectivity** :
 - SSB, RTTY (BW=2.4 kHz) More than 2.4 kHz/–3 dB
Less than 3.6 kHz/–60 dB
 - CW (BW=500 Hz) More than 500 Hz/–3 dB
Less than 700 Hz/–60 dB
 - AM (BW=6 kHz) More than 6.0 kHz/–3 dB
Less than 15.0 kHz/–60 dB
 - FM (BW=15 kHz) More than 12.0 kHz/–6 dB
Less than 20.0 kHz/–60 dB
- **Spurious and image rejection ratio** : More than 70 dB (except IF through on 50 MHz band)
- **Squelch sensitivity (pre-amp OFF)** :
 - SSB, CW, RTTY, PSK31 Less than 5.6 μ V
 - FM Less than 1 μ V
- **RIT variable range** : \pm 9.999 kHz
- **Audio output power** : More than 2.6 W at 10% distortion with an 8 Ω load
- **PHONES connector** : 3-conductor 6.35 (d) mm (1/4")
- **EXT-SP connectors** : 2-conductor 3.5 (d) mm (1/8")/8 Ω

◇ **Antenna tuner**

- **Matching impedance range** : 16.7 to 150 Ω unbalanced
(HF bands; VSWR better than 3:1)
20 to 125 Ω unbalanced
(50 MHz band; VSWR better than 2.5:1)
- **Minimum operating input** : 8 W (HF bands)
15 W (50 MHz band)
- **Tuning accuracy** : VSWR 1.5:1 or less
- **Insertion loss (after tuning)** : Less than 1.0 dB

*The LCD display may have cosmetic imperfections that appear as small or dark spots. This is not a malfunction or defect, but a normal characteristic of LCD displays.

Spurious signals may be received near the following frequencies. These are made in the internal circuit and does not indicate a transceiver malfunction.

- 0.150 MHz • 10.490 MHz

Spurious waveforms may be displayed on the spectrum scope screen regardless of the transceiver's condition (Tx or Rx). They are made in the scope circuit. This does not indicate a transceiver malfunction.

All stated specifications are typical and subject to change without notice or obligation.

Options

- **IC-PW1/EURO** HF/50 MHz ALL BAND 1 kW LINEAR AMPLIFIER



Full-duty-cycle 1 kW linear amplifier including an automatic antenna tuner. Has automatic tuning and band selection capability when used with an Icom transceiver. Full break-in (QSK) operation. The amplifier/power supply unit and the remote control unit are separate.

- **SM-20** DESKTOP MICROPHONE



Unidirectional, electret microphone for base station operation. Includes [UP]/[DOWN] switches and a low cut function.

- **CT-17** CI-V LEVEL CONVERTER



For remote transceiver control using a PC. You can change frequencies, operating mode, memory channels, etc. (software is not included)

- **SP-20** EXTERNAL SPEAKER



4 audio filters; headphone jack; can connect to 2 transceivers.

- Input impedance : 8 Ω
- Max. input power : 5 W

- **HM-36** HAND MICROPHONE



Hand microphone equipped with [UP]/[DOWN] switches.

■ General	16-2
■ Caution	16-2
■ Preparation	16-3
◇ Firmware and firm utility	16-3
◇ File downloading	16-3
■ Firmware update— USB-Memory	16-4
■ Firmware update— PC	16-6
◇ Connections	16-6
◇ IP address setting	16-7
◇ Updating from the PC	16-8

■ General

At least one available USB (2.0 or 1.1) port is required to copy the downloaded firmware file. An Ethernet card/board (10 BASE-T/100 BASE TX compatible) is required when updating the firmware from the PC. The USB hub and Ethernet card/board are not supplied by Icom. Ask your PC dealer about a USB hub and an Ethernet card/board for details.

The IC-7700's firmware can be updated if desired. By updating the firmware, new function(s) can be added and the improvement of performance parameters can be made.

2 methods of firmware update are available: one uses the USB-Memory, and the other uses a PC. You can choose either methods according to your PC capabilities.

- When only one PC connected to the Internet is available
 - ➔ Refer to ■ Preparation (p. 16-3) and ■ Firmware update— USB-Memory (p. 16-4)
- When two or more PCs connected to the Internet are available and they are connected to a LAN (Local Area Network)
 - ➔ Refer to ■ Preparation (p. 16-3) and either
 - Firmware update— PC (p. 16-6) or
 - Firmware update— USB-Memory (p. 16-4)

Ask your dealer or distributor about how to update the firmware if you have no PC.

■ Caution

⚠ **CAUTION!** NEVER turn the transceiver power OFF while updating the firmware.

You can turn the transceiver power OFF only when the transceiver displays that rebooting is required.

If you turn the transceiver power OFF, or if a power failure occurs during updating, the transceiver firmware will be corrupted and you will have to send the transceiver back to the nearest Icom distributor for repair. This type of repair is out of warranty even if the warranty period is still valid.

Recommendation!

Backing up the settings and/or memory contents to the USB-Memory before starting the firmware update is recommended.

Settings and/or memory contents will be lost or returned to default settings when the firmware update is performed.

■ Preparation

◇ Firmware and firm utility

The latest firmware and the firm utility can be downloaded from the Icom home page via the Internet. Access the following URL to download the firm utility and the latest firmware.

<http://www.icom.co.jp/world/support/index.htm>

For updating from the USB-Memory

When updating the firmware from the USB-Memory, copy the downloaded firmware data (e.g. 7700_110.dat) to the USB-Memory (in "IC-7700" folder) using an available USB port (USB hub may be required; purchased separately from your PC dealer).

◇ File downloading

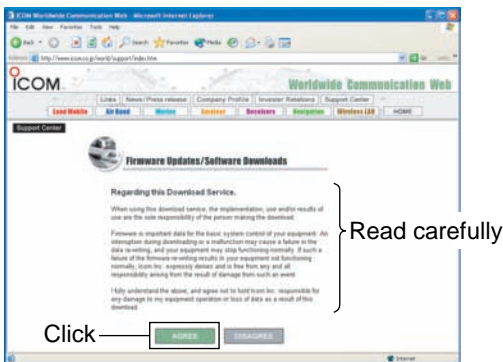

- ① Access the following URL directly.
<http://www.icom.co.jp/world/support/index.htm>
- ② Read "Regarding this Download Service" carefully, then click [AGREE].
- ③ Click "Transceiver" link then click the firmware file link.

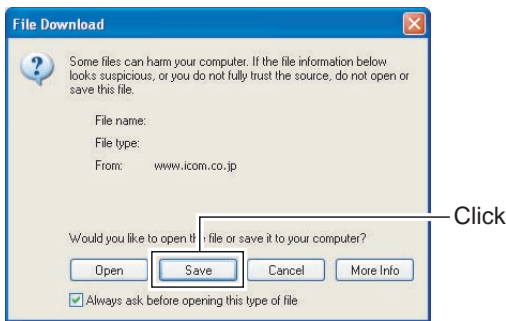

- ④ Click [Save] in the displayed File Download dialog.

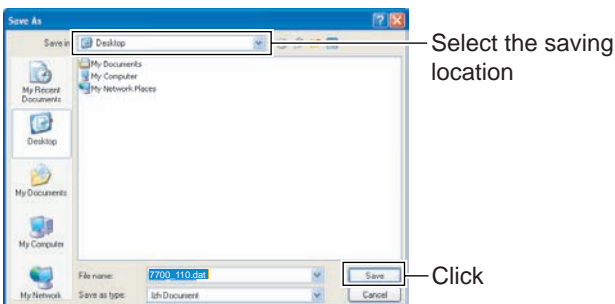

- ⑤ Select the desired location in which you want to save the firmware, then click [Save] in the displayed File Download dialog.
 - File download starts.
- ⑥ After download is completed, extract the file.
 - The firmware and the firm utility are compressed in "zip" format, respectively.
 - When updating the transceiver using with the USB-Memory, copy the extracted firmware (e.g. 7700_110.dat) to the USB-Memory IC-7700 folder.
 - The USB-Memory must have been formatted by the IC-7700. (p. 12-26)

Firmware update— USB-Memory

When updating the firmware with the USB-Memory, no IP address or subnet mask settings are necessary.

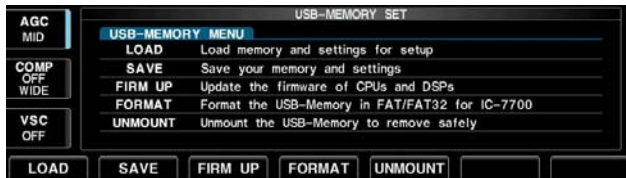
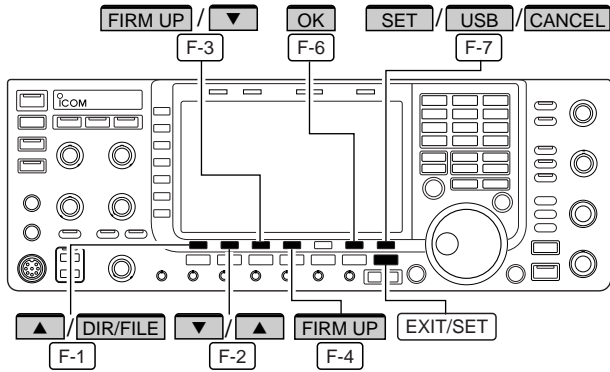

- ① Copy the downloaded firmware data into the USB-Memory ("IC-7700" folder).
 - The USB-Memory must have been formatted by the IC-7700.

- ② Insert the USB-Memory into the USB connector.
- ③ Push [EXIT/SET] several times to close a multi-function screen, if necessary.
- ④ Push [F-7•SET] to select set mode menu screen.
- ⑤ Push [F-7•USB] to select USB-Memory set menu.

- ⑥ Push and hold [F-3•FIRM UP] for 1 sec.

- ⑦ Read the displayed precaution carefully.
 - Push [F-1•▲] or [F-2•▼] to scroll the indication.
 - Push [F-7•CANCEL] to cancel the firmware updating.

- ⑧ After you read and understand all of the precautions, push [F-6•OK].
 - [F-6•OK] appears only following the precautions.
 - Push [F-7•CANCEL] to cancel the firmware updating.

- ⑨ Push [F-2•▲] or [F-3•▼] to select the firmware file, then push [F-4•FIRM UP].

- ⑩ Read the displayed precautions carefully.
- ⑪ If you agree, push and hold [F-6•OK] for 1 sec. to start the firmware update.
 - Push [F-7•CANCEL] to cancel the firmware updating.

- ⑫ While loading the firmware from the USB-Memory, the dialog as at left is displayed.

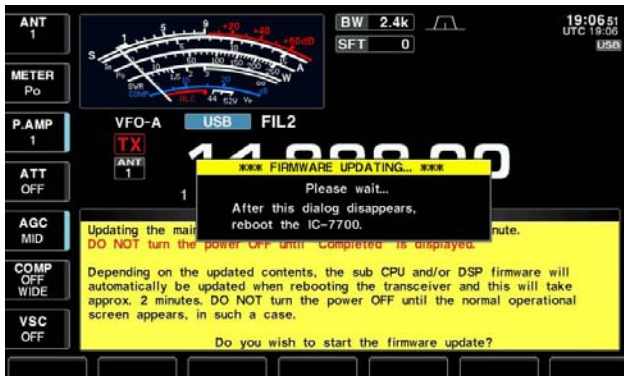

⑬ After the firmware loading is completed, the transceiver starts the update automatically and the dialog at left is displayed.

⚠ **WARNING!** NEVER turn the IC-7700 power OFF at this stage.
 The transceiver firmware will be corrupted.

⑭ When the dialog disappears, the precaution at left is displayed.

⑮ Read the precaution carefully, and then push [F-6•OK].
 • Return to USB-Memory set menu.

⑯ Push [POWER] to turn the IC-7700 power OFF, then ON again.

⑰ Depending on the update, one or two dialog boxes as at left appear in sequence.

⚠ **WARNING!** NEVER turn the IC-7700 power OFF at this stage.
 The transceiver firmware will be corrupted.

⑱ After the dialog disappears, the firmware updating is completed and normal operation screen appears.

■ Firmware update— PC

◇ Connections

Connect the IC-7700 and the PC through a LAN (Local Area Network) as follows.

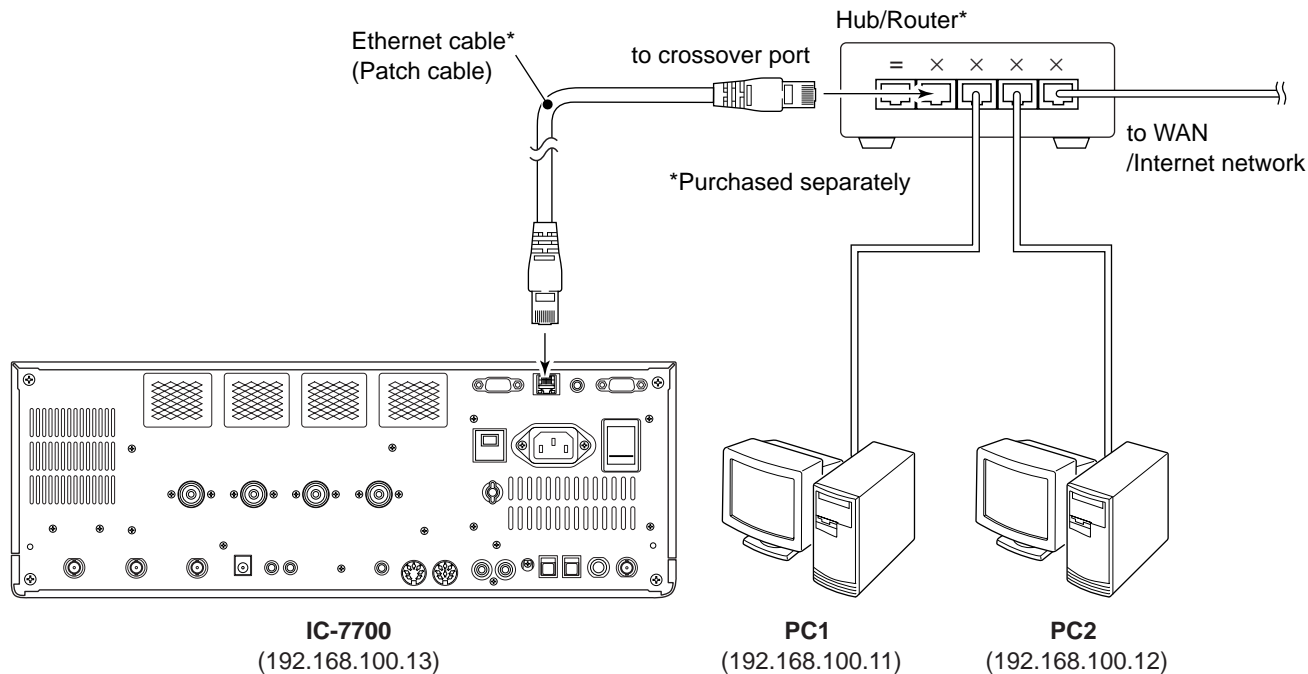

• IP address setting example

	PC1	PC2	IC-7700
IP address	192.168.100.11	192.168.100.12	192.168.100.13
Subnet mask	255.255.255.0	255.255.255.0	255.255.255.0

◇ IP address setting

When updating the firmware from the USB-Memory, the following settings are not necessary.

IMPORTANT!: A fixed (static) IP address is used for the IC-7700.
 When you connect the IC-7700 to a LAN, ask the network manager about a usable/assignable IP address and the subnet mask in advance.
NEVER use an IP address that has already been used with another device in the network. If the IP address is duplicated, the network will crash.

- ① Push [EXIT/SET] several times to close a multi-function screen, if necessary.
- ② Push [F-7•SET] to select set mode menu screen.
- ③ Push [F-5•OTHERS] to select Others set mode.

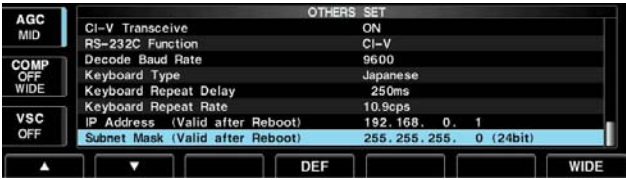
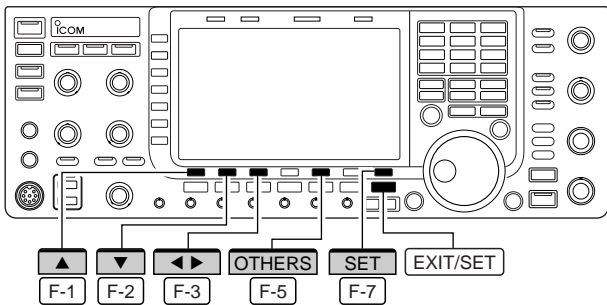

- ④ Push [F-1•▲]/[F-2•▼] several times to select “IP Address” item.
- ⑤ Push [F-3•◀ ▶] to select the desired part then rotate the main dial to set the desired or specified IP address.
 - “192.168.0.1” is the default setting.
- ⑥ Push [F-2•▼] to select “Subnet Mask” item.
- ⑦ Rotate the main dial to set the desired or specified subnet mask.
 - “255.255.255.0” is the default setting.
- ⑧ Push [POWER] to turn the transceiver power OFF, then ON to enable the IP address and subnet mask settings.

◇ Updating from the PC

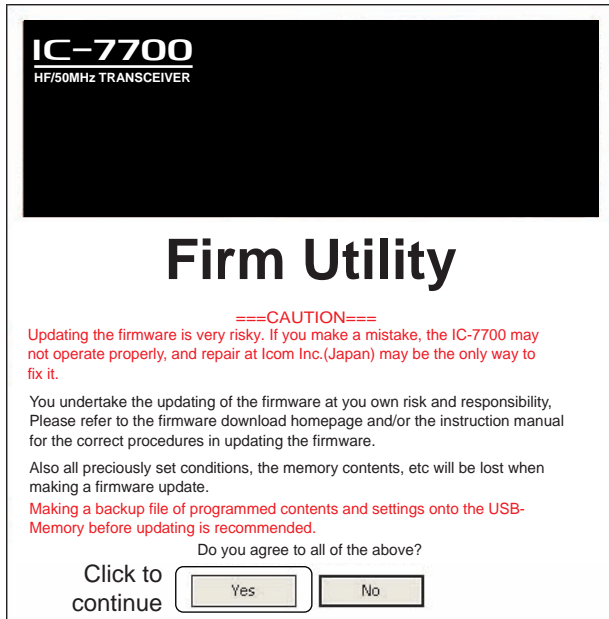

- ① Start up the IC-7700 Firm Utility.
 - The window as at left appears.
- ② Read the caution in the window carefully.
- ③ Click [Yes] if you agree and continue the firmware updating.

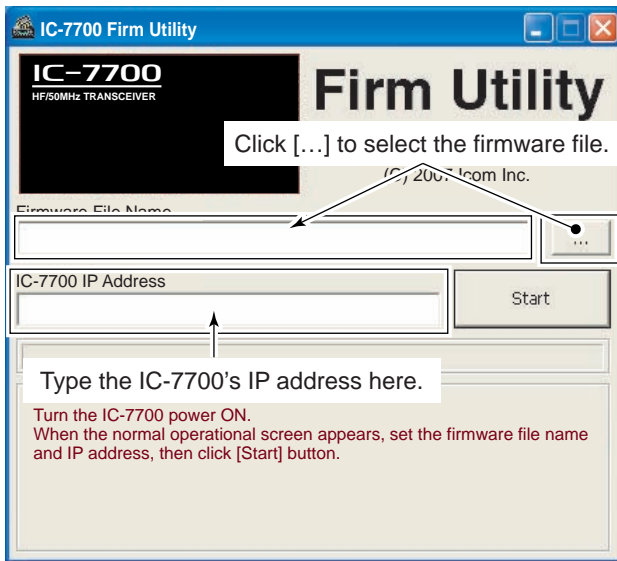

- ④ Select the firmware file, that has "dat" extension (e.g.: 7700_110.dat).
 - Click [...], then select the file, as well as the location.
- ⑤ Type the IC-7700's IP address into "IC-7700 IP Address" text box.
- ⑥ Click [Start].

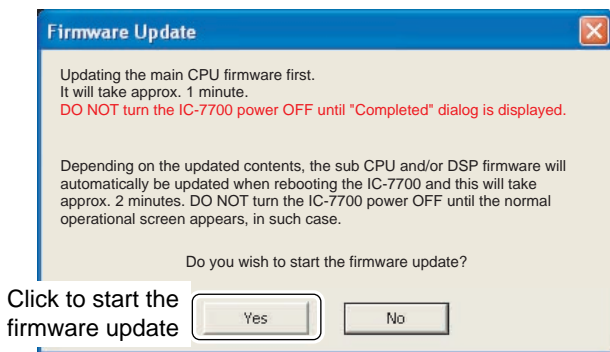

- ⑦ The window as at left appears.
 - Read the precaution in the window carefully.
- ⑧ Click [Yes] if you want to start the firmware update.

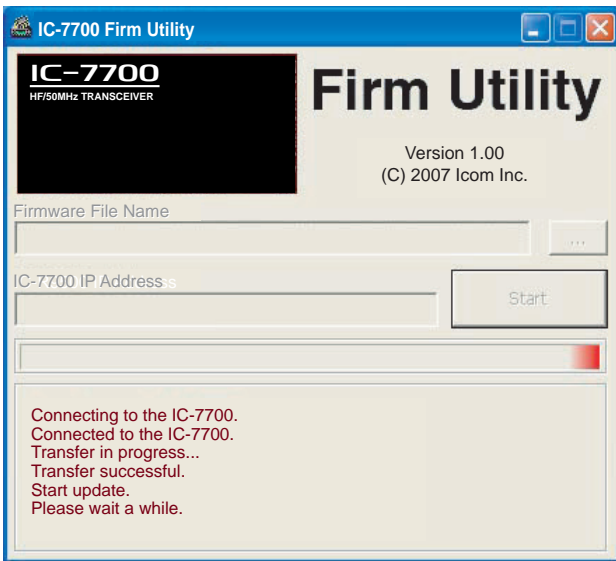

- ⑨ The screen as at left is displayed.
 - The following dialog appears in the IC-7700 display.

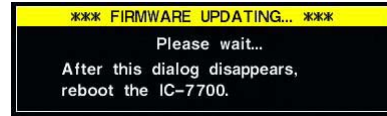

⚠ **WARNING!** NEVER turn the IC-7700 power OFF at this stage.
 The transceiver firmware will be corrupted.

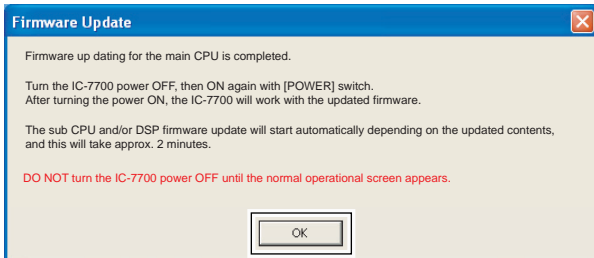

Click [OK] to finish the firmware update.

- ⑩ Click [OK] to finish the firmware update.
 - The “FIRMWARE UPDATING” dialog as above disappears.
- ⑪ Push **[POWER]** to turn the IC-7700 power OFF, then ON again.



- ⑫ Depending on the update, one or two dialog boxes as at left appear on the IC-7700 display in sequence.

⚠ **WARNING!** NEVER turn the IC-7700 power OFF at this stage.
 The transceiver firmware will be corrupted.

- ⑬ After the dialog disappears, the firmware update is completed and normal operation screen appears.

INSTALLATION NOTES

For amateur base station installations it is recommended that the clearance in front of the antenna array is calculated relative to the EIRP (Effective Isotropic Radiated Power). The clearance height below the antenna array can be determined in most cases from the RF power at the antenna input terminals.

Different exposure limits have been recommended for different frequencies, a relative table shows a guideline for installation considerations.

Below 30 MHz, the recommended limits are specified in terms of V/m or A/m fields as they are likely to fall within the near-field region. Similarly, the antennas may be physically short in terms of electrical length and that the installation will require some antenna matching device which can create local, high intensity magnetic fields. Analysis of such installations is best considered in association with published guidance notes such as the FCC OET Bulletin 65 Edition 97-01 and its annexes relative to amateur transmitter installations. The EC recommended limits are almost identical to the FCC specified 'uncontrolled' limits and tables exist that show pre-calculated safe distances for different antenna types for different frequency bands. Further information can be found at <http://www.arrl.org/>.

• Typical amateur radio installation

Exposure distance assumes that the predominant radiation pattern is forward and that radiation downward is at unity gain (side lobe suppression is equal to main lobe gain). This is true of almost every gain antenna today. Exposed persons are assumed to be beneath the antenna array and have a typical height of 1.8 m.

The figures assume the worst-case emission of constant carrier.

For the bands 10 MHz and higher the following power density limits have been recommended:

10–144 MHz 2 W/sq m

EIRP clearance heights by frequency band

1 Watts	2.1 m
10 Watts	2.8 m
25 Watts	3.4 m
100 Watts	5 m
1000 Watts	12 m

Forward clearance, EIRP by frequency band

100 Watts	2 m
1000 Watts	6.5 m
10,000 Watts	20 m
100,000 Watts	65 m

In all cases any possible risk depends on the transmitter being activated for long periods. (actual recommendation limits are specified as an average during 6 minutes) Normally the transmitter is not active for long periods of time. Some radio licenses will require that a timer circuit automatically cuts the transmitter after 1–2 minutes etc.

Similarly some types of emission, i.e., SSB, CW, AM etc. have a lower 'average' output power and the assessed risk is even lower.



Versions of the IC-7700 which display the "CE" symbol on the serial number seal, comply with the essential requirements of the European Radio and Telecommunication Terminal Directive 1999/5/EC.



This warning symbol indicates that this equipment operates in non-harmonised frequency bands and/or may be subject to licensing conditions in the country of use. Be sure to check that you have the correct version of this radio or the correct programming of this radio, to comply with national licensing requirement.

• List of Country codes (ISO 3166-1)

	Country	Codes		Country	Codes
1	Austria	AT	18	Liechtenstein	LI
2	Belgium	BE	19	Lithuania	LT
3	Bulgaria	BG	20	Luxembourg	LU
4	Croatia	HR	21	Malta	MT
5	Czech Republic	CZ	22	Netherlands	NL
6	Cyprus	CY	23	Norway	NO
7	Denmark	DK	24	Poland	PL
8	Estonia	EE	25	Portugal	PT
9	Finland	FI	26	Romania	RO
10	France	FR	27	Slovakia	SK
11	Germany	DE	28	Slovenia	SI
12	Greece	GR	29	Spain	ES
13	Hungary	HU	30	Sweden	SE
14	Iceland	IS	31	Switzerland	CH
15	Ireland	IE	32	Turkey	TR
16	Italy	IT	33	United Kingdom	GB
17	Latvia	LV			



We Icom Inc. Japan
1-1-32, Kamiminami, Hirano-ku
Osaka 547-0003, Japan

Declare on our sole responsibility that this equipment complies with the essential requirements of the Radio and Telecommunications Terminal Equipment Directive, 1999/5/EC, and that any applicable Essential Test Suite measurements have been performed.

Kind of equipment: HF/50 MHz ALL MODE TRANSCEIVER

Type-designation: IC-7700

Version (where applicable): _____

This compliance is based on conformity with the following harmonised standards, specifications or documents:

- i) EN 301489-1 v1.4.1 (2002-08)
- ii) EN 301489-15 v1.2.1 (2002-08)
- iii) EN 301 783 v1.1.1 (2000-09)
- iv) EN 60950-1 (2001):A11:2004

DECLARATION OF CONFORMITY



Düsseldorf 16th Nov.2007
Place and date of issue

Icom (Europe) GmbH
Himmelgeister straÙe 100
D-40225 Düsseldorf

Authorized representative name
H. Ikegami
General Manager

Signature

Icom Inc.

Please record the serial number of your IC-7700 transceiver below for future servicing reference:

Serial Number : _____

Date of purchase : _____

Place where purchased : _____

Count on us!

IC-7700
#03 (Europe)

<Intended Country of Use>	
<input type="checkbox"/> AT	<input type="checkbox"/> BE <input type="checkbox"/> CY <input type="checkbox"/> CZ <input type="checkbox"/> DK <input type="checkbox"/> EE
<input type="checkbox"/> FI	<input type="checkbox"/> FR <input type="checkbox"/> DE <input type="checkbox"/> GR <input type="checkbox"/> HU <input type="checkbox"/> IE
<input type="checkbox"/> IT	<input type="checkbox"/> LV <input type="checkbox"/> LT <input type="checkbox"/> LU <input type="checkbox"/> MT <input type="checkbox"/> NL
<input type="checkbox"/> PL	<input type="checkbox"/> PT <input type="checkbox"/> SK <input type="checkbox"/> SI <input type="checkbox"/> ES <input type="checkbox"/> SE
<input type="checkbox"/> GB	<input type="checkbox"/> IS <input type="checkbox"/> LI <input type="checkbox"/> NO <input type="checkbox"/> CH <input type="checkbox"/> BG
<input type="checkbox"/> RO	<input type="checkbox"/> TR <input type="checkbox"/> HR

IC-7700
#04 (France)

<Intended Country of Use>	
<input type="checkbox"/> AT	<input type="checkbox"/> BE <input type="checkbox"/> CY <input type="checkbox"/> CZ <input type="checkbox"/> DK <input type="checkbox"/> EE
<input type="checkbox"/> FI	<input type="checkbox"/> FR <input type="checkbox"/> DE <input type="checkbox"/> GR <input type="checkbox"/> HU <input type="checkbox"/> IE
<input type="checkbox"/> IT	<input type="checkbox"/> LV <input type="checkbox"/> LT <input type="checkbox"/> LU <input type="checkbox"/> MT <input type="checkbox"/> NL
<input type="checkbox"/> PL	<input type="checkbox"/> PT <input type="checkbox"/> SK <input type="checkbox"/> SI <input type="checkbox"/> ES <input type="checkbox"/> SE
<input type="checkbox"/> GB	<input type="checkbox"/> IS <input type="checkbox"/> LI <input type="checkbox"/> NO <input type="checkbox"/> CH <input type="checkbox"/> BG
<input type="checkbox"/> RO	<input type="checkbox"/> TR <input type="checkbox"/> HR

IC-7700
#05 (Italy)

<Intended Country of Use>	
<input type="checkbox"/> AT	<input type="checkbox"/> BE <input type="checkbox"/> CY <input type="checkbox"/> CZ <input type="checkbox"/> DK <input type="checkbox"/> EE
<input type="checkbox"/> FI	<input type="checkbox"/> FR <input type="checkbox"/> DE <input type="checkbox"/> GR <input type="checkbox"/> HU <input type="checkbox"/> IE
<input type="checkbox"/> IT	<input type="checkbox"/> LV <input type="checkbox"/> LT <input type="checkbox"/> LU <input type="checkbox"/> MT <input type="checkbox"/> NL
<input type="checkbox"/> PL	<input type="checkbox"/> PT <input type="checkbox"/> SK <input type="checkbox"/> SI <input type="checkbox"/> ES <input type="checkbox"/> SE
<input type="checkbox"/> GB	<input type="checkbox"/> IS <input type="checkbox"/> LI <input type="checkbox"/> NO <input type="checkbox"/> CH <input type="checkbox"/> BG
<input type="checkbox"/> RO	<input type="checkbox"/> TR <input type="checkbox"/> HR

IC-7700
#06 (Spain)

<Intended Country of Use>	
<input type="checkbox"/> AT	<input type="checkbox"/> BE <input type="checkbox"/> CY <input type="checkbox"/> CZ <input type="checkbox"/> DK <input type="checkbox"/> EE
<input type="checkbox"/> FI	<input type="checkbox"/> FR <input type="checkbox"/> DE <input type="checkbox"/> GR <input type="checkbox"/> HU <input type="checkbox"/> IE
<input type="checkbox"/> IT	<input type="checkbox"/> LV <input type="checkbox"/> LT <input type="checkbox"/> LU <input type="checkbox"/> MT <input type="checkbox"/> NL
<input type="checkbox"/> PL	<input type="checkbox"/> PT <input type="checkbox"/> SK <input type="checkbox"/> SI <input type="checkbox"/> ES <input type="checkbox"/> SE
<input type="checkbox"/> GB	<input type="checkbox"/> IS <input type="checkbox"/> LI <input type="checkbox"/> NO <input type="checkbox"/> CH <input type="checkbox"/> BG
<input type="checkbox"/> RO	<input type="checkbox"/> TR <input type="checkbox"/> HR

IC-7700
#07 (United
Kingdom)

<Intended Country of Use>	
<input type="checkbox"/> AT	<input type="checkbox"/> BE <input type="checkbox"/> CY <input type="checkbox"/> CZ <input type="checkbox"/> DK <input type="checkbox"/> EE
<input type="checkbox"/> FI	<input type="checkbox"/> FR <input type="checkbox"/> DE <input type="checkbox"/> GR <input type="checkbox"/> HU <input type="checkbox"/> IE
<input type="checkbox"/> IT	<input type="checkbox"/> LV <input type="checkbox"/> LT <input type="checkbox"/> LU <input type="checkbox"/> MT <input type="checkbox"/> NL
<input type="checkbox"/> PL	<input type="checkbox"/> PT <input type="checkbox"/> SK <input type="checkbox"/> SI <input type="checkbox"/> ES <input type="checkbox"/> SE
<input type="checkbox"/> GB	<input type="checkbox"/> IS <input type="checkbox"/> LI <input type="checkbox"/> NO <input type="checkbox"/> CH <input type="checkbox"/> BG
<input type="checkbox"/> RO	<input type="checkbox"/> TR <input type="checkbox"/> HR

Free Manuals Download Website

<http://myh66.com>

<http://usermanuals.us>

<http://www.somanuals.com>

<http://www.4manuals.cc>

<http://www.manual-lib.com>

<http://www.404manual.com>

<http://www.luxmanual.com>

<http://aubethermostatmanual.com>

Golf course search by state

<http://golfingnear.com>

Email search by domain

<http://emailbydomain.com>

Auto manuals search

<http://auto.somanuals.com>

TV manuals search

<http://tv.somanuals.com>