



INSTRUCTION MANUAL

HF ALL BAND TRANSCEIVER
IC-718



IMPORTANT

READ THIS INSTRUCTION MANUAL CAREFULLY before attempting to operate the transceiver.

SAVE THIS INSTRUCTION MANUAL. This manual contains important safety and operating instructions for the IC-718.

EXPLICIT DEFINITIONS

WORD	DEFINITION
⚠ WARNING	Personal injury, fire hazard or electric shock may occur.
CAUTION	Equipment damage may occur.
NOTE	Inconvenience only. No risk of personal injury, fire or electric shock.

PRECAUTIONS

⚠ WARNING HIGH VOLTAGE! NEVER attach an antenna or internal antenna connector during transmission. This may result in an electric shock or burn.

⚠ NEVER apply AC to the [DC13.8V] jack on the transceiver rear panel. This could cause a fire or ruin the transceiver.

⚠ NEVER apply more than 16 V DC, such as a 24 V battery, to the [DC13.8V] jack on the transceiver rear panel. This could cause a fire or ruin the transceiver.

⚠ NEVER let metal, wire or other objects touch any internal part or connectors on the rear panel of the transceiver. This may result in an electric shock.

NEVER expose the transceiver to rain, snow or any liquids.

AVOID using or placing the transceiver in areas with temperatures below -10°C ($+14^{\circ}\text{F}$) or above $+60^{\circ}\text{C}$ ($+140^{\circ}\text{F}$). Be aware that temperatures on a vehicle's dashboard can exceed 80°C ($+176^{\circ}\text{F}$), resulting in permanent damage to the transceiver if left there for extended periods.

AVOID placing the transceiver in excessively dusty environments or in direct sunlight.

AVOID placing the transceiver against walls or putting anything on top of the transceiver. This will obstruct heat dissipation.

During mobile operation, **DO NOT** operate the transceiver without running the vehicle's engine. When transceiver power is ON and your vehicle's engine is OFF, the vehicle's battery will soon become exhausted.

Make sure the transceiver power is OFF before starting the vehicle. This will avoid possible damage to the transceiver by ignition voltage spikes.

During maritime mobile operation, keep the transceiver and microphone as far away as possible from the magnetic navigation compass to prevent erroneous indications.

BE CAREFUL! The heatsink will become hot when operating the transceiver continuously for long periods.

BE CAREFUL! If a linear amplifier is connected, set the transceiver's RF output power to less than the linear amplifier's maximum input level, otherwise, the linear amplifier will be damaged.

Use Icom microphones only (supplied or optional). Other manufacturer's microphones have different pin assignments, and connection to the IC-718 may damage the transceiver.

IMPORTANT	i	6 MEMORY OPERATION	35–38
EXPLICIT DEFINITIONS	i	■ Memory channels	35
PRECAUTIONS	i	■ Memory channel selection	35
1 TABLE OF CONTENTS	1	■ Memory channel programming	36
SUPPLIED ACCESSORIES	1	■ Frequency transferring	37
		■ Memory clearing	38
2 PANEL DESCRIPTION	2–8	7 SCANS	39–40
■ Front panel	2	■ Scan types	39
■ Function display	5	■ Preparation	39
■ Rear panel	6	■ Programmed scan operation	40
■ Microphone (HM-36)	8	■ Memory scan operation	40
3 INSTALLATION AND CONNECTIONS	9–14	8 SET MODE	41–47
■ Unpacking	9	■ General	41
■ Selecting a location	9	■ Quick set mode items	42-43
■ Grounding	9	■ Initial set mode items	44-47
■ Antenna connection	9	9 INSTALLATION AND CONNECTIONS	48–51
■ Required connections	10	■ Opening the transceiver's case	48
■ Advanced connections	11	■ Optional bracket and carrying handle.....	48
■ Power supply connections	12	■ CR-338 HIGH STABILITY CRYSTAL UNIT	49
■ Liner amplifier connections	13	■ UT-102 VOICE SYNTHESIZER UNIT	49
■ External antenna tuners	14	■ UT-106 DSP RECEIVE UNIT	50
4 FREQUENCY SETTING	15–19	■ Optional IF filters	50
■ When first applying power	15	■ AT-180 internal switch description	51
■ Initial setting	15	10 MAINTENANCE	52–53
■ VFO description	16	■ Troubleshooting	52
■ Frequency setting	17	■ Fuse replacement	53
■ Dial lock function	19	■ Resetting the CPU	53
5 RECEIVE AND TRANSMIT	20–34	11 SPECIFICATIONS	54
■ Mode selection	20	12 OPTIONS	55–56
■ Squelch and RF gain	20	13 CONTROL COMMAND	57–58
■ Function for receive	21	■ Remote jack (CI-V) information	57
■ DSP function (option)	23	14 INTERNAL VIEWS	59
■ Filter selection	24	■ Top view	59
■ Filter setting	25	■ Bottom view	59
■ Function for transmit	26	15 INSTALLATION NOTES	60
■ Split frequency operation	30	■ DECLARATION OF CONFORMITY	61
■ SWR	30		
■ Function for CW	31		
■ Function for RTTY	33		

SUPPLIED ACCESSORIES

The transceiver comes with the following accessories.

	Qty.
① DC power cable	1
② Hand microphone (HM-36)	1
③ Fuse (FGB 20 A; for DC cable)	1
④ Fuse (FGB 4 A; internal use)	1

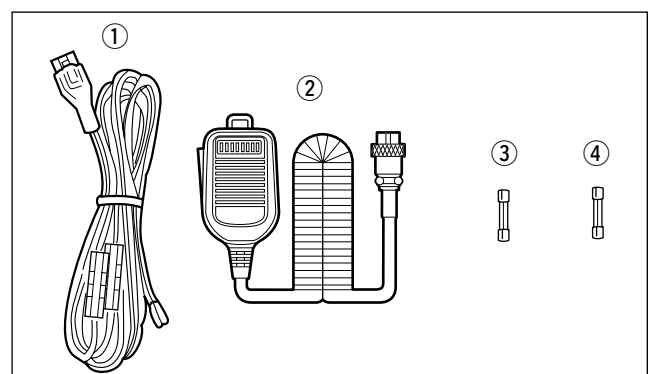

■ Front panel

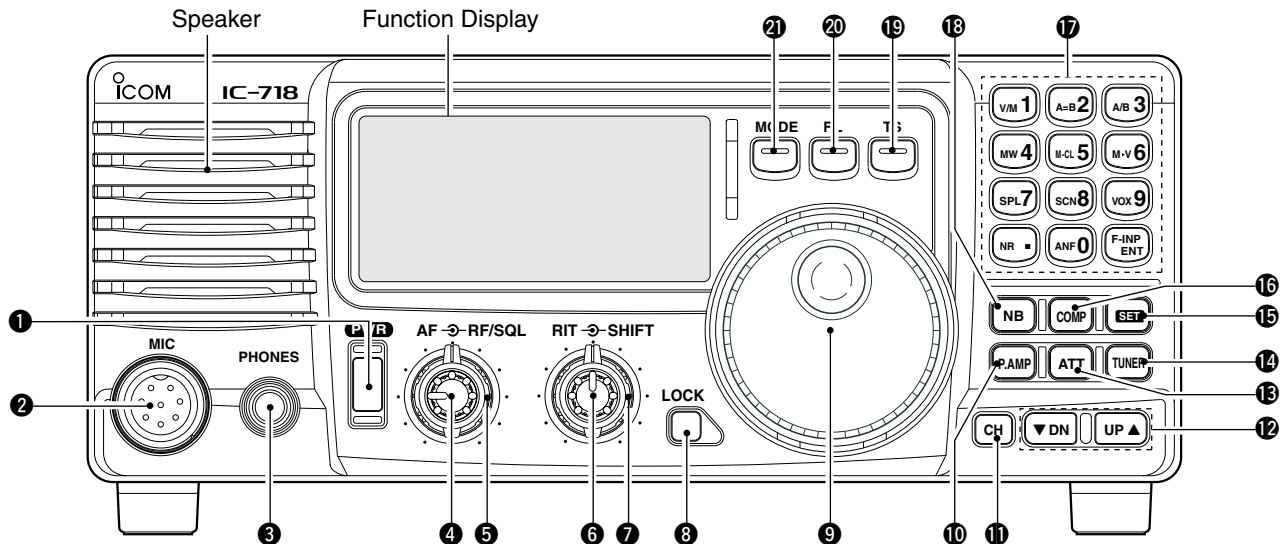

1 POWER SWITCH [PWR]

- ↪ Push momentarily to turn power ON.
 - Turn the optional DC power supply ON in advance.
- ↪ Push for 1 sec. to turn power OFF.
- ↪ While pushing and holding [SET], push [PWR] to enter the initial set mode. (p. 41)

2 MICROPHONE CONNECTOR [MIC]

- Accepts supplied or optional microphone.
- See p. 55 for appropriate microphones.
- See p. 8 for microphone connector information.

3 HEADPHONE JACK [PHONES] (p. 11)

- Accepts headphones (8 Ω).
- When headphones are connected, the internal speaker or connected external speaker does not function.

4 AF CONTROL [AF] (inner control)

- Varies the audio output level from the speaker.

5 RF GAIN/SQUELCH CONTROL [RF/SQL]

- (outer control; pgs. 20, 44)
- Adjusts the squelch threshold level. The squelch removes noise output from the speaker (closed condition) when no signal is received.
- The squelch is available for all modes.
- The control can be set as the squelch plus RF gain controls or squelch control only (RF gain is fixed at maximum) in initial set mode.

6 RIT CONTROLS [RIT] (Inner control; p. 21)

- ↪ Shifts the receive frequency without changing the transmit frequency.
- Rotate the control clockwise to increase the frequency,

or rotate the control counterclockwise to decrease the frequency. "RIT" appears on the display.

- The shift frequency range is ± 1.2 kHz.

7 IF SHIFT CONTROLS [SHIFT] (Outer control; p. 21)

Shifts the center frequency of the receiver's IF pass-band.

- Rotate the control clockwise to shift the center frequency higher, or rotate the control counterclockwise to shift the center frequency lower.

8 LOCK SWITCH [LOCK] (p. 19)

Push momentarily to turn the dial lock function ON and OFF.

- The dial lock function electronically locks the main dial.
- When the optional UT-102 VOICE SYNTHESIZER UNIT is installed (p. 49), push for 1 sec. to have the frequency, etc. announced.
- UT-102 operation can be adjusted in initial set mode (p. 46).

9 MAIN DIAL

Changes the displayed frequency, selects quick/initial set mode items, etc.

10 PREAMP SWITCH [P.AMP] (p. 21)

Push momentarily to turn the preamp ON or OFF.

11 CH SWITCH [CH] (p. 35)

Push momentarily to turn the memory channel select function ON or OFF.

- [MEMO] blinks while memory channel select function is turned on.

- Push several times (or push and hold) [▼ DN]/[UP ▲] until desired memory channel appears.
- After pushing [F-INP/ENT], push desired memory channel number from the keypad, then push [FINP/ENT] again to select the memory channel directory.
- Push [CH] to exit the memory channel select function.

12 MEMORY CHANNEL (BAND) UP/DOWN SWITCHES [▼ DN]/[UP ▲] (p. 35)

- ↳ Push one or more times to select the memory channel, while [MEMO] indicator is blinking.
- ↳ Push to select a band.
- ↳ Push to select the quick/initial set mode items while quick/initial set mode is selected.

13 ATTENUATOR SWITCH [ATT] (p. 22)

Push to toggle the 20 dB attenuator function ON and OFF.

14 TUNER SWITCH [TUNER] (pgs. 28, 29)

- ↳ Push momentarily to toggle the automatic antenna tuner function ON/OFF.
 - An optional antenna tuner must be connected.
- ↳ Push for 1 sec. to manually tune the tuner.
 - An optional antenna tuner must be connected.
 - When the tuner cannot tune the antenna, the tuning circuit is bypassed automatically after 20 sec.

15 SET SWITCH [SET]

- ↳ Push for 1 sec. to enter the quick set mode. (p. 41)
- ↳ Pushing and holding [SET], and then push [POWER] to enter the initial set mode. (p. 41)
- ↳ Push to toggle the meter function; (p. 26)
 - PO: indicates the relative RF output power.
 - ALC: Indicates ALC level.
 - SWR: indicates the SWR over the transmission line.

16 MIC COMPRESSOR SWITCH [COMP] (p. 27)

Toggles the Mic. compressor function ON and OFF.

17 KEYPAD

The keypad can be used for several functions as described below:

- [F-INP/ENT], keypad then [F-INP/ENT].
 - Direct frequency input. (pgs. 4, 7)
- [CH], [F-INP/ENT], keypad then [F-INP/ENT] then [V/M]
 - Memory channel selection. (pgs. 4, 35)
- [V/M], [A=B], [A/B], [MW], [M-CL], [M▶V], [SPL], [SCAN], [VOX], [NR] (option) and [ANF] (option) switch. (p. 4)

18 NOISE BLANKER SWITCH [NB] (p. 22)

- ↳ Toggles the noise blanker ON and OFF. The noise blanker reduces pulse-type noise such as that generated by automobile ignition systems. This function is not effective against non pulse-type noise.

- ↳ Push [NB] for 1 sec to enter the noise blanker level setting condition.

19 QUICK TUNING STEP SWITCH [TS] (pgs. 18, 19)

- ↳ Selects a quick tuning step or turns the quick tuning step OFF.
 - While the quick tuning indicator (▼) is displayed, the frequency can be changed in kHz step.
- ↳ While the quick tuning step is OFF, it turns the 1 Hz step ON and OFF when pushed for 1 sec.
 - 1 Hz indication appears and the frequency can be changed in 1 Hz steps.
- ↳ While the kHz quick tuning step is selected, it enters tuning step set mode when pushed for 1 sec.

20 FILTER SWITCH [FIL] (p. 24)

- ↳ Push momentarily to toggle between the pre-programmed normal, wide and narrow IF filters for the selected operating mode.

21 MODE SWITCHES [LSB/USB]/[CW/CW-R]/[RTTY/RTTY-R]/[AM] (p. 20)

- Push to toggle an operating mode.
- Push [MODE] for 1 sec. during SSB mode to toggle between LSB or USB.
 - Push [MODE] for 2 sec. during CW or RTTY mode, to toggle between CW and CW reverse or RTTY and RTTY reverse. "REV" appears on the display.

■ Front panel (continued)

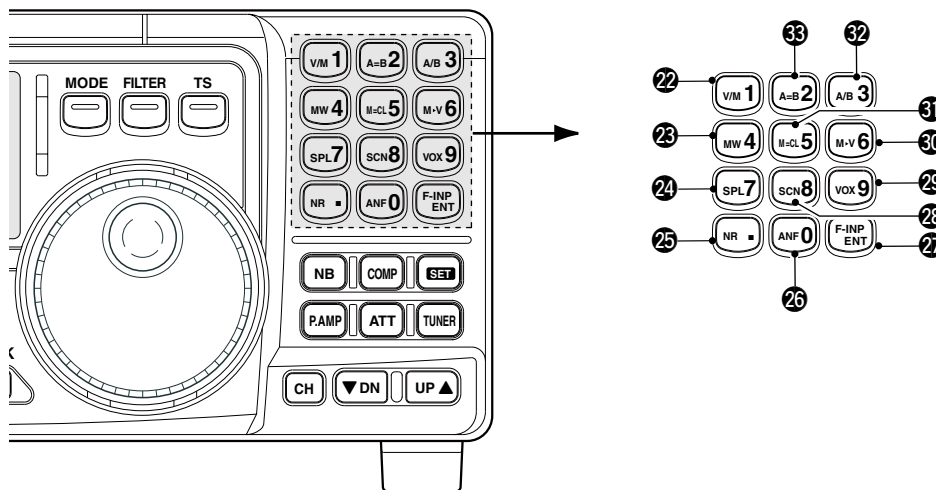

22 VFO/MEMORY SWITCH/1 [V/M•1] (pgs. 16, 35)
 ↳ Toggles the operating mode between VFO mode or memory mode when pushed.

23 MEMORY WRITE SWITCH/4 [MW•4] (p. 36)
 ↳ Stores the displayed frequency and operating mode into the selected memory channel when pushed for 1 sec.

24 SPLIT SWITCH/7 [SPL•7] (p. 30)
 Turns the split frequency operation ON or OFF when pushed.

25 NR SWITCH/. [NR• .] (p. 23)
 ↳ Toggles the optional noise reduction function ON or OFF when pushed. Functions in all modes.
 • An optional UT-106 DSP UNIT is required.
 • [NR] appears on the display.
 ↳ Enters noise reduction level set mode when pushed for 1 sec.

26 ANF SWITCH/0 [ANF•0] (p. 23)
 Toggles the Automatic Notch Filter function ON or OFF. Functions in SSB and AM modes.
 • An optional UT-106 DSP UNIT is required.
 • [ANF] appears on the display.

27 FRQUENCY INPUT/ENTER SWITCH [F-INP/ENT]
 ↳ [F-INP/ENT], then keypad then [F-INP/ENT]
 — Direct frequency input. (p. 17)
 ↳ [CH] then [F-INP/ENT], then keypad then [F-INP/ENT]. Push [CH].
 — Direct memory number selection. (p. 35)

28 SCAN SWITCH/8 [SCAN•8] (p. 39)
 ↳ Push momentarily to start/stop the programmed scan in VFO mode.
 ↳ Push momentarily to start/stop the memory scan in memory mode.

29 VOX SWITCH/9 [VOX•9] (p. 27)
 ↳ Turn the VOX function ON or OFF when pushed in SSB modes.

30 M▶V SWITCH/6 [MV•6] (p. 37)
 ↳ Transfers the memory contents to VFO when pushed for 1 sec.

31 MEMORY CLEAR SWITCH/5 [M=CL•5] (p. 38)
 Clears the selected readout memory channel contents when pushed for 1 sec. in memory mode.
 • [BLANK] appears above the memory channel number.

32 VFO SELECT SWITCH/3 [A/B•3] (p. 16)
 ↳ Toggles between VFO A or VFO B in VFO mode.
 ↳ Toggles between transmission VFO and reception VFO during split operation.

33 VFO EQUALIZATION SWITCH/2 [A=B•2]
 Equalize the frequency and operating mode of the two VFO's.
 • The VFO B frequency and operating mode are equalized with the VFO A frequency and operating mode.

■ Function display

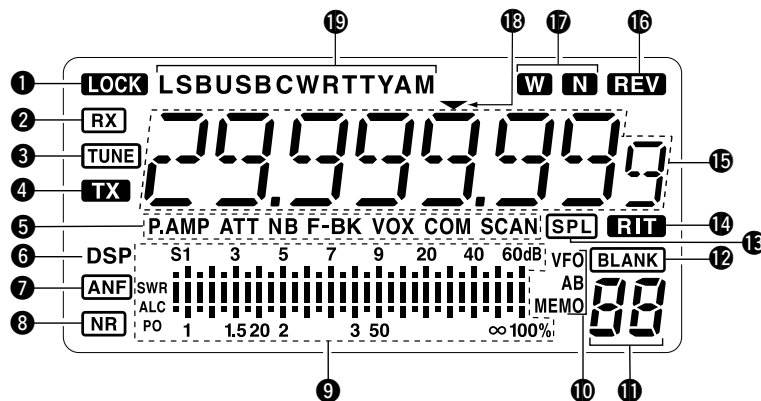

- 1 LOCK INDICATOR** (p. 19)
Appears when the dial lock function is in use.
- 2 RECEIVE INDICATOR**
Appears while receiving a signal or when the squelch is open.
- 3 TUNE INDICATOR**
Appears while the automatic tuning function is activated.
- 4 TRANSMIT INDICATOR**
Appears while transmitting.
- 5 FUNCTION INDICATORS**
 - ↳ “P.AMP” appears when antenna preamp is in use.
 - ↳ “ATT” appears when the attenuator function is in use.
 - ↳ “NB” appears when the Noise Blanker function is turned ON.
 - ↳ “BK” appears when the semi break-in function is selected in quick set mode.
 - ↳ “F-BK” appears when the full break-in function activates in CW mode. (p. 31)
 - ↳ “VOX” appears when the VOX function is selected in quick set mode.
 - ↳ “COM” appears when the speech compressor activates in SSB mode.
 - ↳ “SCAN” appears when the scan function is activated.
 - Flashes when scan is paused.
- 6 DSP UNIT INDICATOR**
Appears when an optional UT-106 DSP UNIT is installed.
- 7 AUTOMATIC NOTCH FILTER INDICATOR** (p. 23)
Appears when the optional Automatic Notch Filter function is in use.
- 8 NOISE REDUCTION INDICATOR** (p. 23)
Appears when the optional Noise Reduction function is in use.
- 9 SIGNAL/SQL/RF-GAIN METER**
 - ↳ Functions as an S-meter while receiving.
 - ↳ Functions as a Power, ALC or SWR meter while transmitting. (p. 26)
- 10 VFO/MEMORY INDICATOR** (p. 16)
“VFO A” or “B” appears when VFO mode is selected.
“MEMO” appears when memory mode is selected.
- 11 MEMORY CHANNEL NUMBER READOUT** (p. 35)
Shows the selected memory channel number.
- 12 BLANK INDICATOR** (p. 38)
Shows that the displayed memory channel is not programmed.
 - This indicator appears both in VFO and memory mode.
- 13 SPLIT INDICATORS** (p. 30)
Appears when the split frequency operation is in use.
- 14 RIT INDICATOR** (p. 21)
Appears when the RIT function is in use.
- 15 FREQUENCY READOUT**
Shows the operating frequency.
- 16 REVERSE INDICATOR** (p. 20)
Appears when the CW reverse or RTTY reverse mode is selected.
- 17 WIDE/NARROW FILTER INDICATORS** (pgs. 24, 25)
 - ↳ “W” appears when the wide IF filter is selected.
 - ↳ “N” appears when the narrow IF filter is selected.
- 18 PROGRAMMABLE TUNING STEP INDICATORS**
Appears when the programmable tuning step is selected.
- 19 MODE INDICATORS** (p. 20)
Indicates the selected operating mode.

■ Rear panel

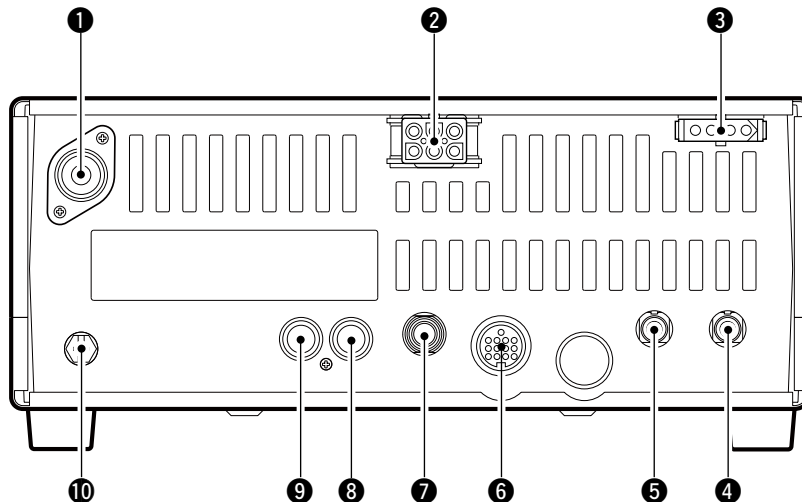

1 ANTENNA TERMINAL [ANT] (p. 10)

Connects a 50 Ω antenna with a PL-259 connector and a 50 Ω coaxial cable.

2 DC POWER SOCKET [DC 13.8V] (p. 12)

Accepts 13.8V DC through the supplied DC power cable.

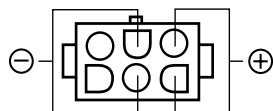

Rear panel view

3 TUNER CONTROL SOCKET [TUNER] (p. 14)

Accepts the control cable from an optional AH-4 AUTOMATIC ANTENNA TUNER.

4 CI-V REMOTE CONTROL JACK [REMOTE] (p. 57)

Designed for use with a personal computer for remote operation of transceiver functions.

5 EXTERNAL SPEAKER JACK [EXT SP] (p. 11)

Connects an 8 Ω external speaker, if desired.
 • When an external speaker is connected, the internal speaker does not function.

6 ACCESSORY SOCKET [ACC] (p. 7)

Enables connection to external equipment such as an optional AT-180 AUTOMATIC ANTENNA TUNER, a TNC for data communications or a liner amplifier, etc.

7 ELECTRONIC KEYSER JACK [KEY]

Accepts a paddle to activate the internal electronic keyer.

- Selection between the internal electronic keyer and straight key operation can be made in initial set mode.

When connecting a straight key

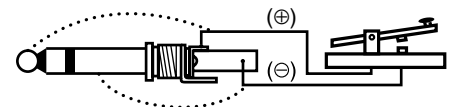

When connecting a paddle

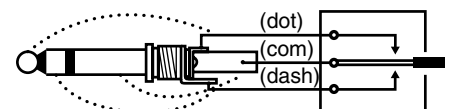

8 ALC INPUT JACK [ALC]

Connects to the ALC output jack of a non-Icom linear amplifier.

9 SEND CONTROL JACK [SEND] (p. 14)

Goes to ground while transmitting to control external equipments such as a liner amplifier.
 • Max. control level: 16 V DC/2 A

10 GROUND TERMINAL [GND] (p. 9)

Connects the terminal to ground.

◇ ACC SOCKET INFORMATION

• ACC socket

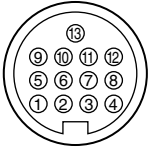
ACC	PIN #	NAME	DESCRIPTION	SPECIFICATIONS
 <p>Rear panel view</p>	1	8 V	Regulated 8 V output.	Output voltage : 8 V ±0.3 V Output current : Less than 10 mA
	2	GND	Connects to ground.	—————
	3	SEND	Input/output pin. Goes to ground when transmitting. When grounded, transmits.	Ground level : -0.5 V to 0.8 V Input current : Less than 20 mA
	4	BDT	Data line for the optional AT-180.	—————
	5	BAND	Band voltage output. (Varies with amateur band)	Output voltage : 0 to 8.0 V
	6	ALC	ALC voltage input.	Control voltage : -4 to 0 V Input impedance : More than 10 kΩ
	7	NC	—————	—————
	8	13.8 V	13.8 V output when power is ON.	Output current : Max. 1 A
	9	TKEY	Key line for the AT-180.	—————
	10	FSKK	RTTY keying input.	Ground level : -0.5 to 0.8 V Input current : Less than 10 mA
	11	MOD	Modulator input.	Input impedance : 10 kΩ Input level : Approx. 100 mV rms
	12	AF	AF detector output. Fixed, regardless of [AF] position.	Output impedance : 4.7 kΩ Output level : 100 to 300 mV rms
	13	SQLS	Squelch output. Goes to ground when squelch opens.	SQL open : Less than 0.3 V/5 mA SQL closed : More than 6.0 V/100 μA

• When connecting the ACC conversion cable (OPC-599)

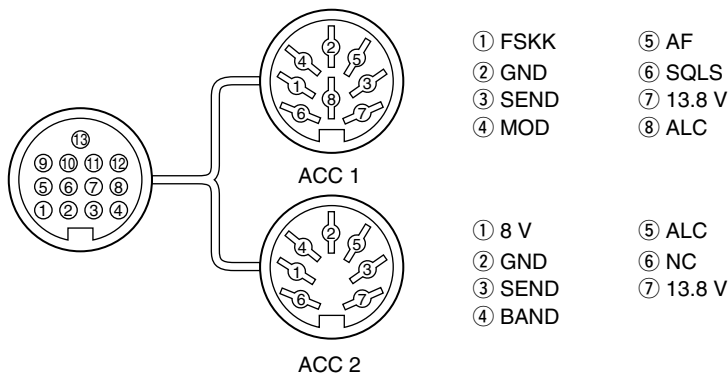

■ Microphone (HM-36)

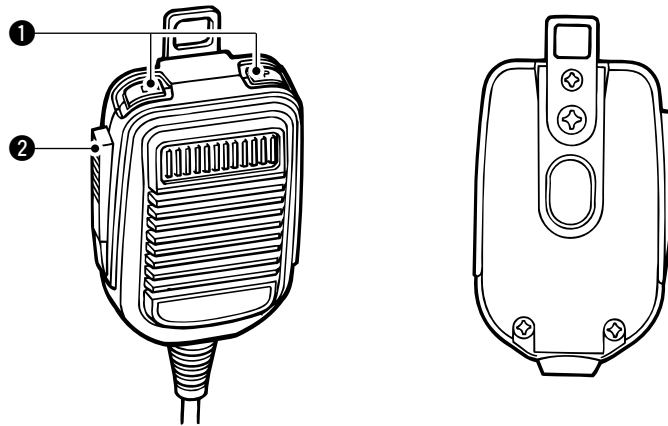

❶ UP/DOWN SWITCHES [UP]/[DN]

Change the selected readout frequency or memory channel.

- Continuous pushing changes the frequency or memory channel number continuously.
- The [UP]/[DN] switch can simulate a key paddle. Preset in the CW PADDL in initial set mode. (p. 31)

❷ PTT SWITCH

Push and hold to transmit; release to receive.

• MICROPHONE CONNECTOR

(Front view)

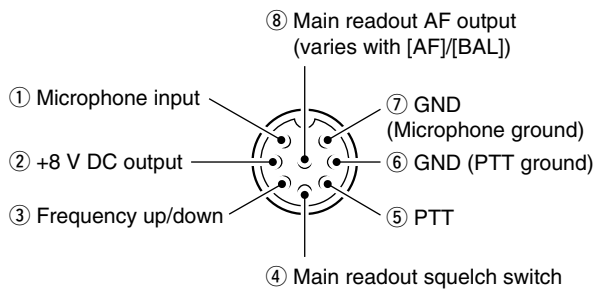

[MIC] PIN NO.	FUNCTION	DESCRIPTION
❷	+8 V DC output	Max. 10 mA
❸	Frequency up	Ground
	Frequency down	Ground through 470 Ω
❹	Squelch open	"LOW" level
	Squelch closed	"HIGH" level

CAUTION: DO NOT short pin 2 to ground as this can damage the internal 8 V regulator.

• HM-36 SCHEMATIC DIAGRAM

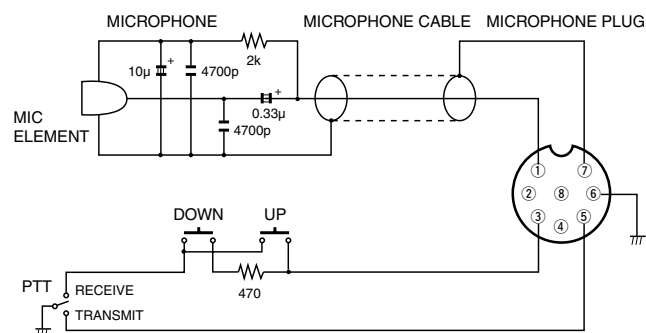

■ Unpacking

After unpacking, immediately report any damage to the delivering carrier or dealer. Keep the shipping cartons.

For a description and a diagram of accessory equipment included with the IC-718, see 'Supplied accessories' on p. 1 of this manual.

■ Selecting a location

Select a location for the transceiver that allows adequate air circulation, free from extreme heat, cold, or vibrations, and away from TV sets, TV antenna elements, radios and other electro-magnetic sources.

The base of the transceiver has an adjustable stand for desktop use. Set the stand to one of two angles depending on your operating conditions.

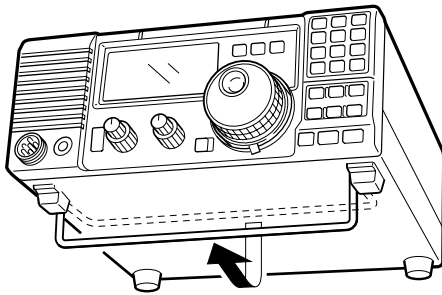

■ Grounding

To prevent electrical shock, television interference (TVI), broadcast interference (BCI) and other problems, ground the transceiver through the GROUND terminal on the rear panel.

For best results, connect a heavy gauge wire or strap to a long earth-sunk copper rod. Make the distance between the [GND] terminal and ground as short as possible.

WARNING: NEVER connect the [GND] terminal to a gas or electric pipe, since the connection could cause an explosion or electric shock.

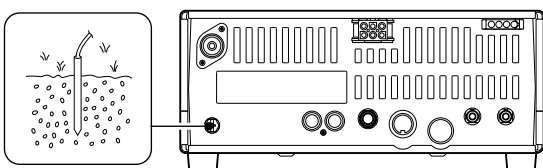

■ Antenna connection

For radio communications, the antenna is of critical importance, along with output power and sensitivity. Select antenna(s), such as a well-matched 50 Ω antenna, and feedline. 1.5:1 or better of Voltage Standing Wave Ratio (VSWR) is recommended for your desired band. Of course, the transmission line should be a coaxial cable.

CAUTION: Protect your transceiver from lightning by using a lightning arrestor.

PL-259 CONNECTOR INSTALLATION EXAMPLE

- ① Slide the coupling ring down. Strip the cable jacket and soft solder.
- ② Strip the cable as shown at left. Soft solder the center conductor.
- ③ Slide the connector body on and solder it.
- ④ Screw the coupling ring onto the connector body.

30 mm ≈ 9/8 in 10 mm ≈ 3/8 in 1-2 mm ≈ 1/16 in

Antenna SWR

Each antenna is tuned for a specified frequency range and SWR may be increased out-of-range. When the SWR is higher than approx. 2.0:1, the transceiver's power drops to protect the final transistor. In this case, an antenna tuner is useful to match the transceiver and antenna. Low SWR allows full power for transmitting even when using the antenna tuner. The IC-718 has an SWR meter to monitor the antenna SWR continuously.

3 INSTALLATION AND CONNECTIONS

■ Required connections

• Front panel

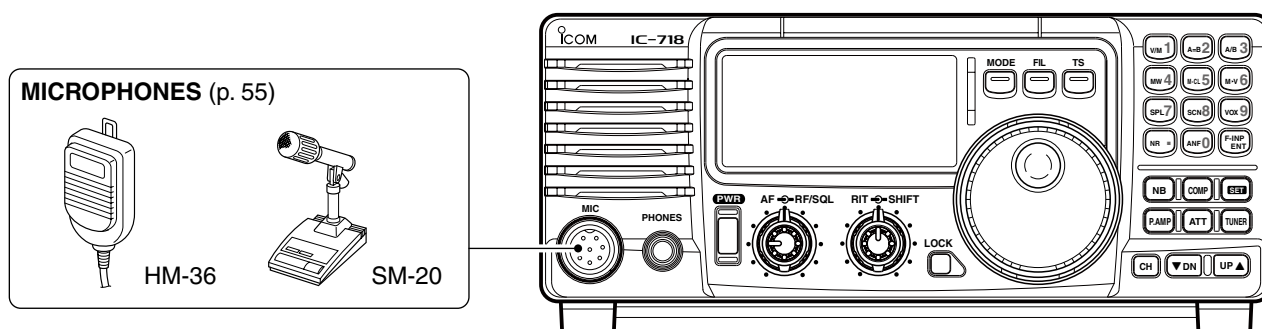

• Rear panel

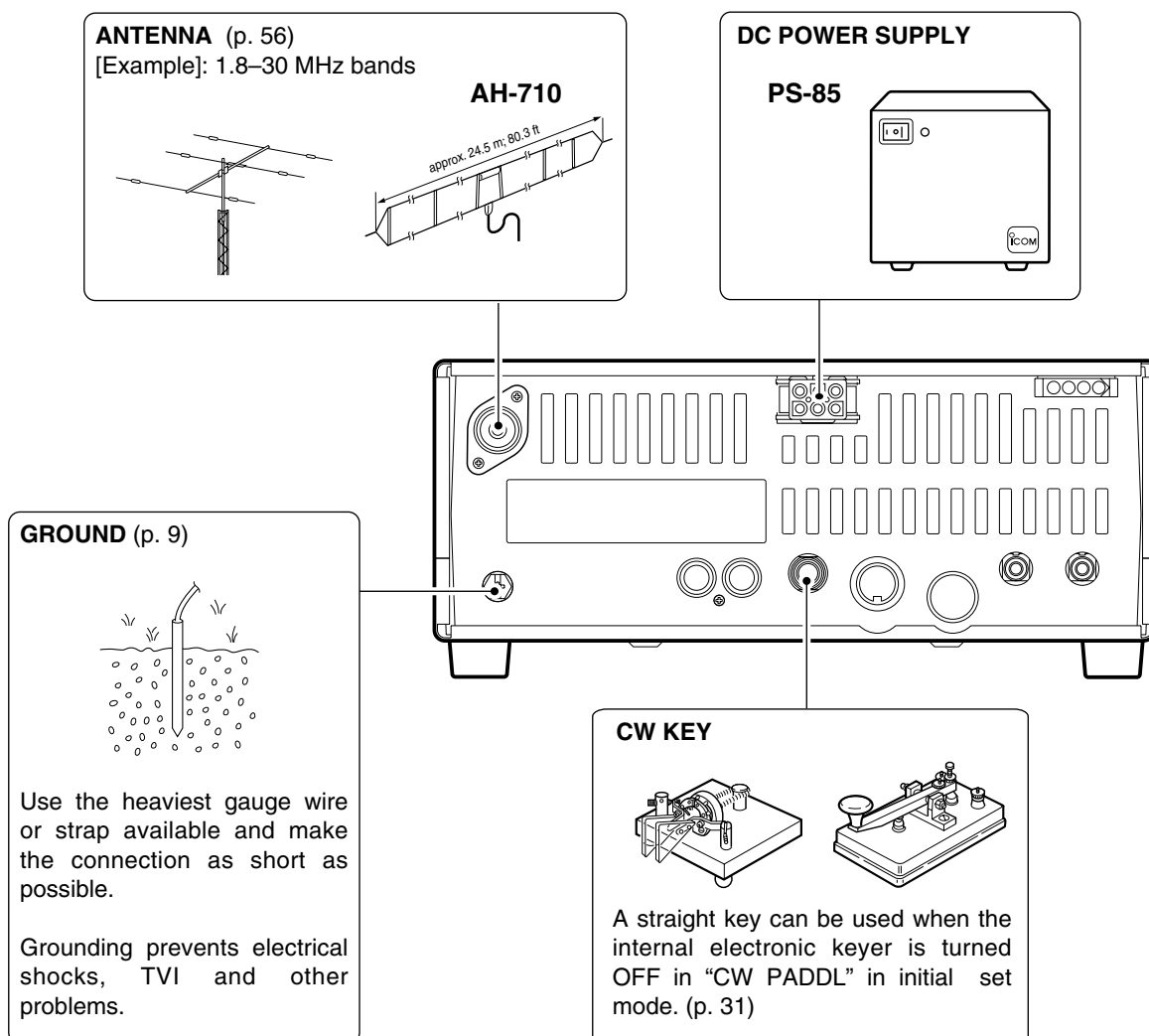

■ Advanced connections

• Front panel

MIC
The AFSK modulation signal can be input from [MIC]. (p. 33)

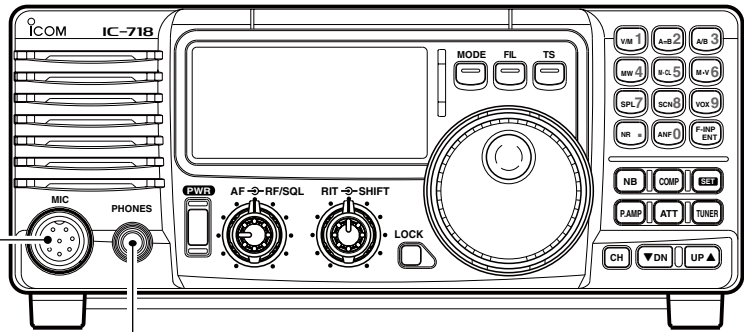

HEADPHONES



• Rear panel

AH-4 (p. 55)

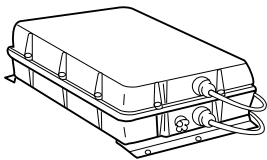

with

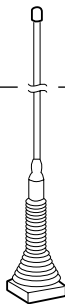

AH-2b
or long wire

[REMOTE] (p. 57)

Used for computer control and transceive operation.

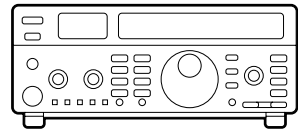

ANTENNA (p. 13)

Connects a liner amplifier, etc.

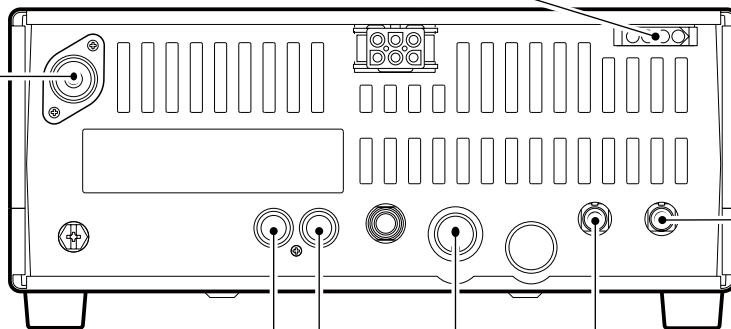

ACC SOCKETS (p. 7)

[SEND], [ALC]

(p. 14)

Used for connecting a non-Icom linear amplifier.

EXTERNAL SPEAKER (p. 55)

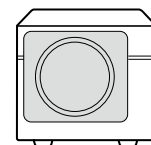

SP-21, etc

3 INSTALLATION AND CONNECTIONS

■ Power supply connections

Use an optional PS-85 DC POWER SUPPLY when operating the IC-718 with AC power. Refer to the diagrams below.

CAUTION: Before connecting the DC power cable, check the following important items. Make sure:

- The [POWER] switch is OFF.
- Output voltage of the power source is 12–15 V when you use a non-Icom power supply.
- DC power cable polarity is correct.
 - Red : positive ⊕ terminal
 - Black : negative ⊖ terminal

CONNECTING PS-85 DC POWER SUPPLY

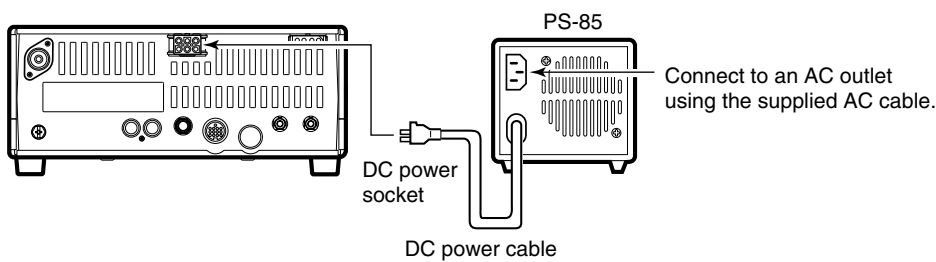

CONNECTING NON-ICOM DC POWER SUPPLY

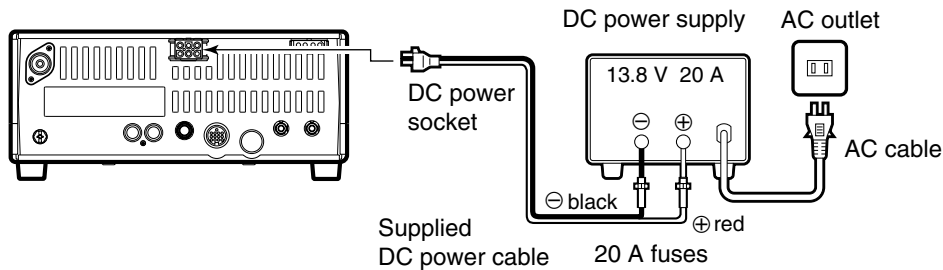

CONNECTING A VEHICLE BATTERY

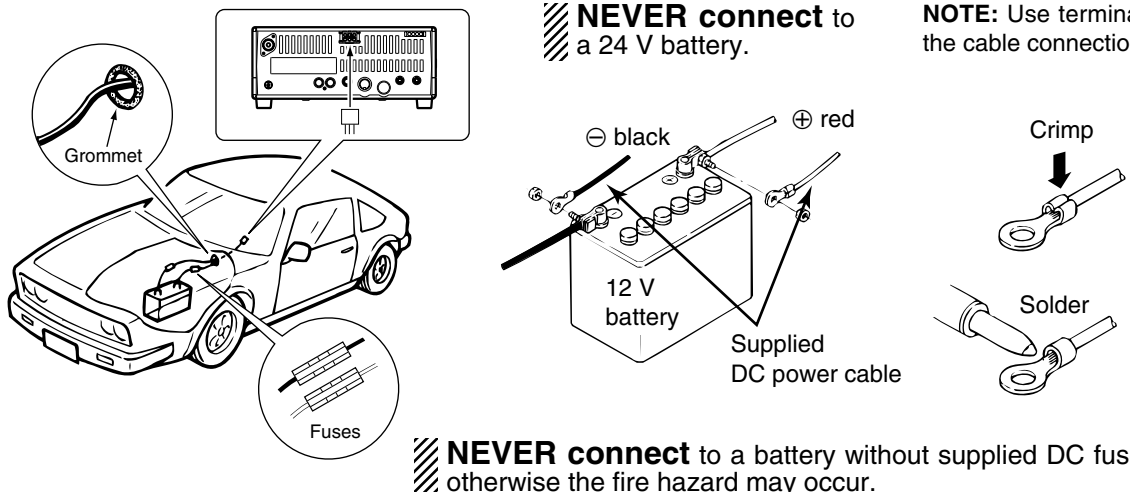

■ Linear amplifier connections

CONNECTING THE IC-PW1

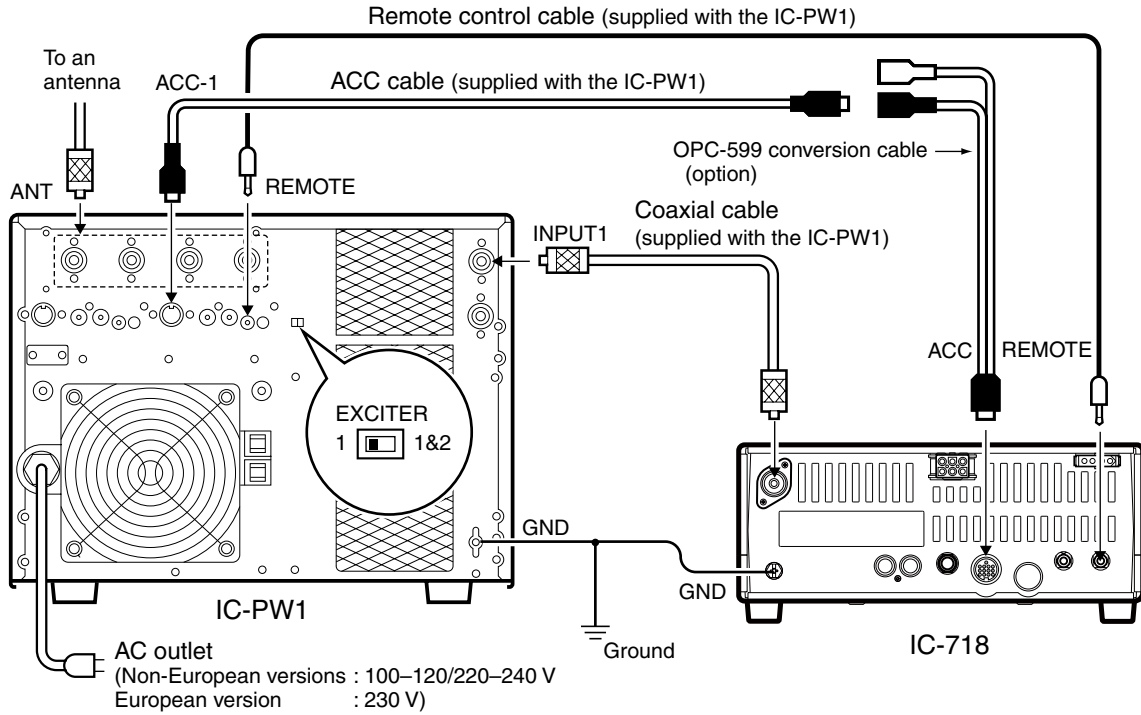

CONNECTING THE IC-4KL

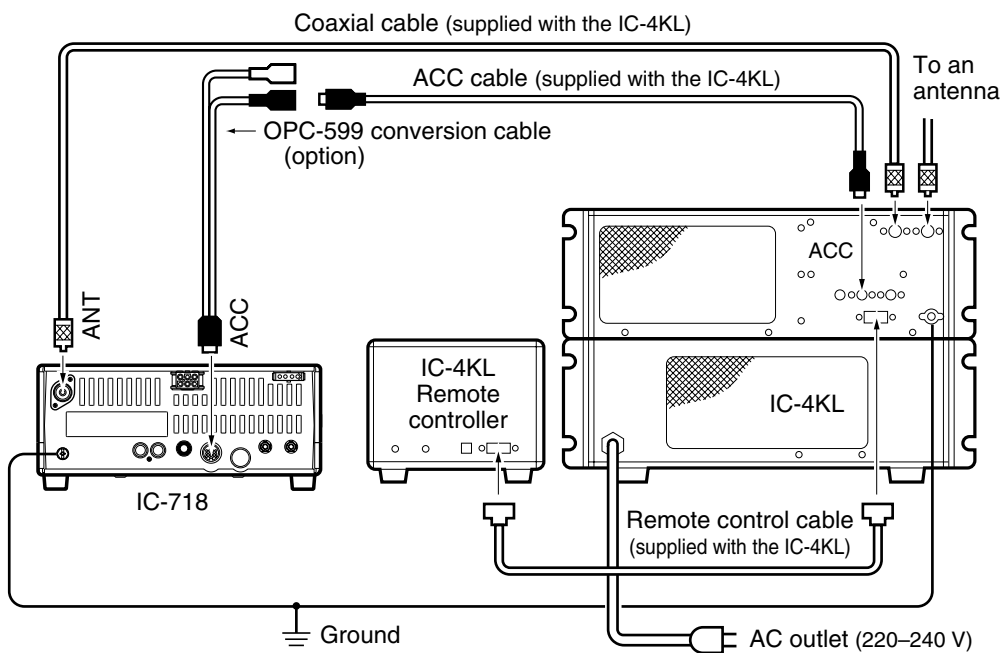

3 INSTALLATION AND CONNECTIONS

CONNECTING A NON-ICOM LINER AMPLIFIER

WARNING:
Set the transceiver output power and linear amplifier ALC output level referring to the linear amplifier instruction manual.

The ALC input level must be in the range 0 V to -4 V, and the transceiver does not accept positive voltage. Non-matched ALC and RF power settings could cause a fire or ruin the linear amplifier.

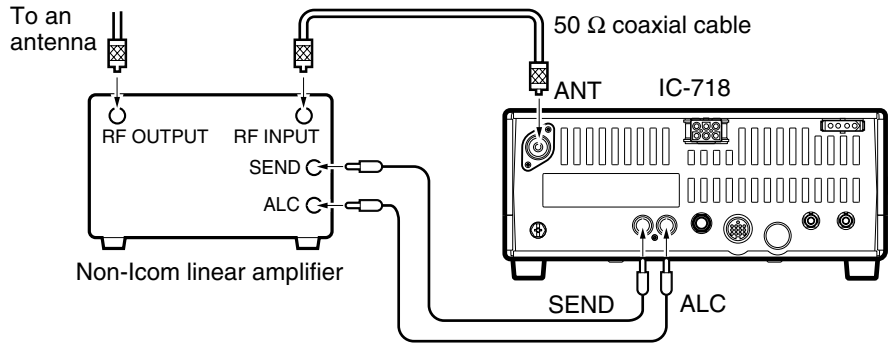

The specifications for the SEND relay are 16 V DC 2 A. If this level is exceeded, a large external relay must be used.

External antenna tuners

CONNECTING THE AH-4 (p. 29)

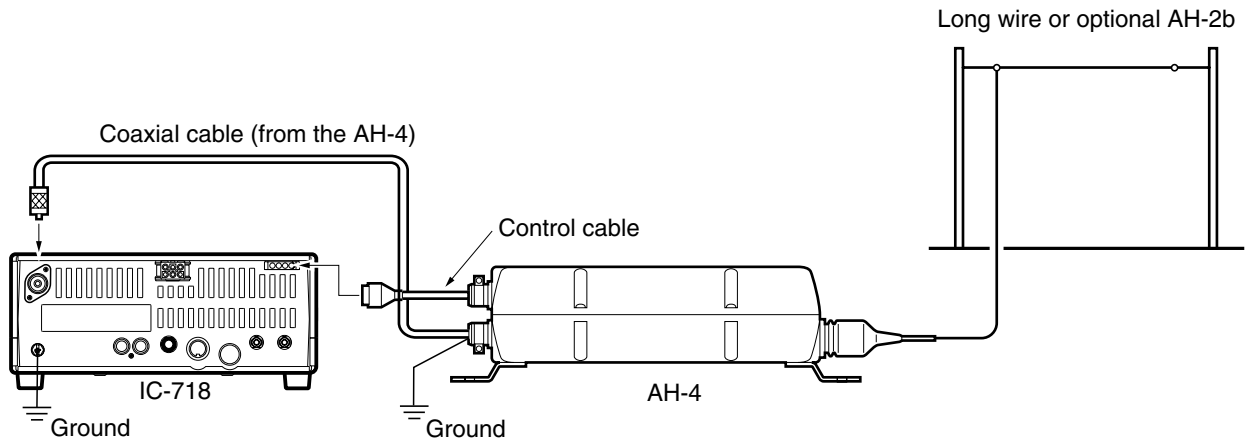

CONNECTING THE AT-180 (p. 28)

DO NOT! connect AT-180 and AH-4 at the same time. Both tuners will not function correctly.

Turn the IC-718's power OFF when connecting the AT-180, otherwise, the CPU may malfunction and the AT-180 may not function properly.

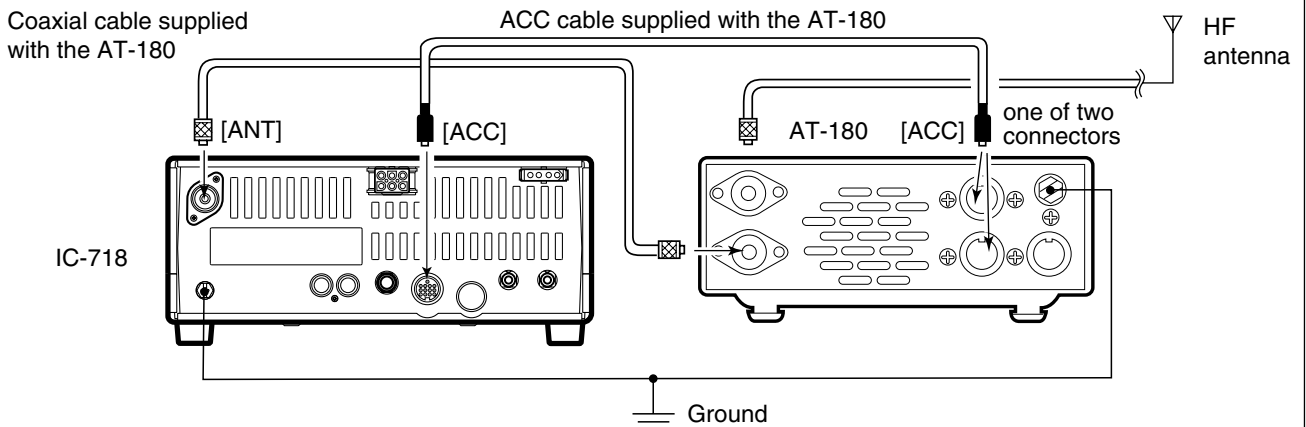

■ When first applying power (CPU resetting)

Before first applying power, make sure all connections required for your system are complete by referring to Chapter 3. Then, reset the transceiver using the following procedure.

Resetting **CLEARs** all programmed contents in memory channels and returns programmed values in quick/initial set mode to default values.

- ① Make sure the transceiver power is OFF.
- ② While pushing and holding [▲ UP] and [▼ DN], push [PWR] for 1 sec. to turn power ON.
 - The internal CPU is reset.
 - The transceiver displays its initial VFO frequencies when resetting is complete.
- ③ All quick/initial set mode settings are returned to default values. (p. 41)

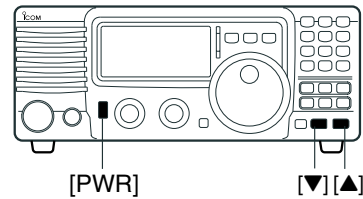

Under cooler temperatures, the LCD may appear dark and unstable after turning power ON. This is normal and does not indicate any equipment malfunction.

■ Initial settings

After resetting the transceiver, set controls and switches as shown in the figure below.

CCW : counterclockwise

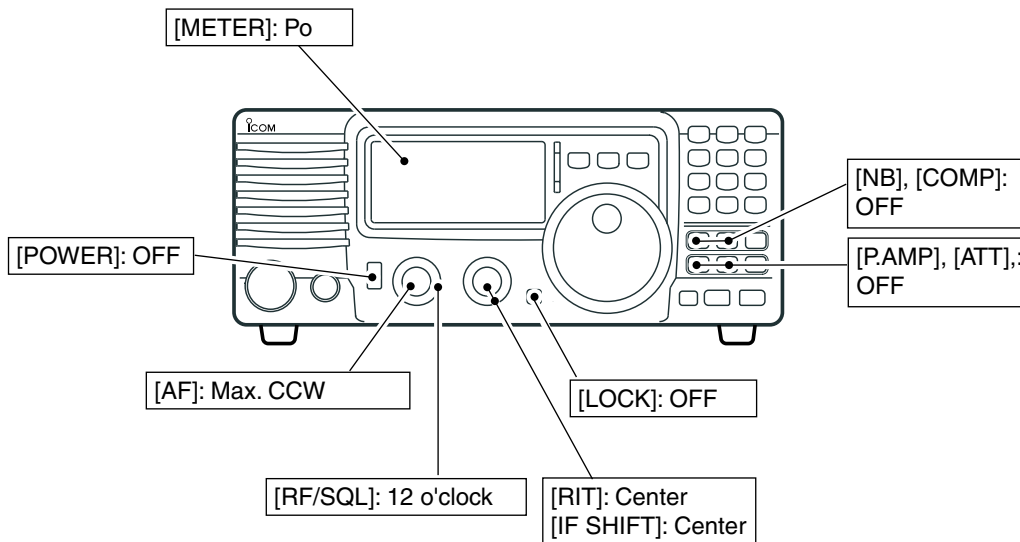

Turn power ON, then check the display. If any of the following indicators appear, turn them OFF as follows:

- Quick tuning step indicator “▼”: Push [TS].
- 1 Hz frequency readout : Push [TS] for 1 sec. (while quick tuning step is OFF)
- RIT indicator “ **RIT** ” : Center.
- Split indicator “ **SPL** ” : Push [SPL].

■ VFO description

VFO is an abbreviation of Variable Frequency Oscillator, and traditionally refers to an oscillator.

The IC-718 VFO can store a frequency and an operating mode.

You can call up a desired frequency to the VFO with the keypad or the memory transfer function (see p. 37). You can also change the frequency with the tuning dial and select the operating mode with the [MODE] switch or call up previously accessed frequency and modes with the band stacking register (p. 18).

The IC-718 has two VFOs, specially suited for split frequency operation. The VFOs are called VFO A and VFO B. You can call up the desired VFO.

• Differences between VFO mode and memory mode

VFO MODE

Each VFO shows a frequency and operating mode. If the frequency or operating mode is changed, the VFO automatically memorizes the new frequency or new operating mode.

When the VFO is selected from another VFO or memory mode, the last-used frequency and operating mode for that VFO appears.

[EXAMPLE]

VFO is selected.

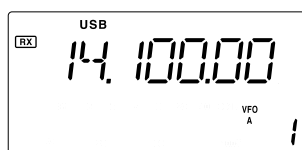

The frequency is changed.

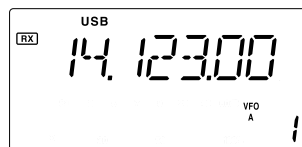

Memory mode is selected.

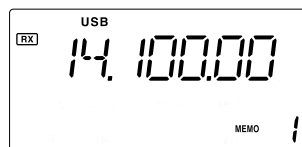

VFO is selected again.

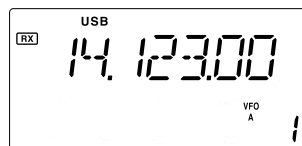

Changed frequency (14.123 MHz) appears.

MEMORY MODE (pgs. 35–38)

Each memory channel shows a frequency and operating mode like a VFO. Even if the frequency or mode is changed, the memory channel does not memorize the new frequency or operating mode.

When the memory channel is selected from another memory channel or VFO mode, the memorized frequency and operating mode appear.

[EXAMPLE]

Memory channel 1 is selected.

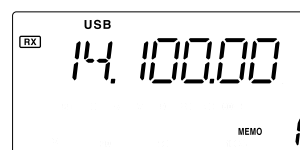

The frequency is changed.

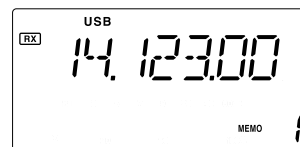

Another memory channel is selected.

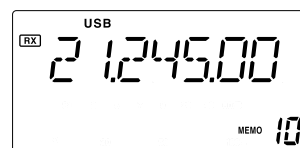

Memory channel 1 is selected again.

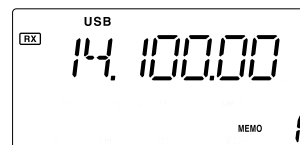

Changed frequency (14.123 MHz) does not appear and memorized frequency (14.100 MHz) appears instead.

■ Frequency setting

◇ Using the tuning dial

- ① Push [▲ UP] or [▼ DN] one or more times to select the desired ham band.

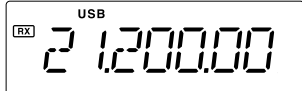

- ② Select the desired operating mode with the mode switch. (p. 20).

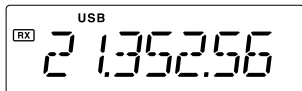

- ③ Rotate the tuning dial to set the desired frequency

• For general coverage receiver use

The IC-718 has a general coverage receiver band.

- ① Push [▲ UP] or [▼ DN] one or more times to select the general coverage receiver band.

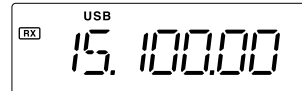

Note: Even if you select the ham band, you can set the transceiver to the general coverage frequency. When the displayed frequency exits the transmit frequency range (ham band), a band edge beep may be emitted (depends on initial set mode programming).

◇ Direct frequency entry with keypad

The transceiver has a keypad for direct frequency entry as described below.

- ① Push [F-INP/ENT], then push the numeral keys on the keypad to enter the MHz digits for the desired frequency.
 - If a key is mistakenly pushed, push [SET] (or any key except keypad) and start again from the beginning.
 - When entering the same MHz digits as the displayed frequency, this step can be skipped.

- ② Push [•] on the keypad.
- ③ Push the numeral keys to enter the frequency digits below 1 MHz.
 - If a key is mistakenly pushed, push [SET] (or any key except keypad) and start again from the beginning.
- ④ Push [F-INP/ENT] to set the input frequency.
 - When pushing [F-INP/ENT] after entering the MHz digits, zeros are automatically entered for the kHz digits.

[EXAMPLE]

•Start

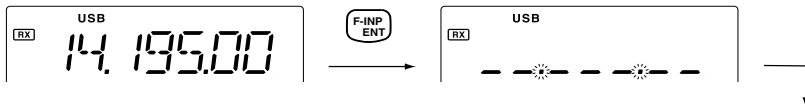

•To set to 21.025 MHz

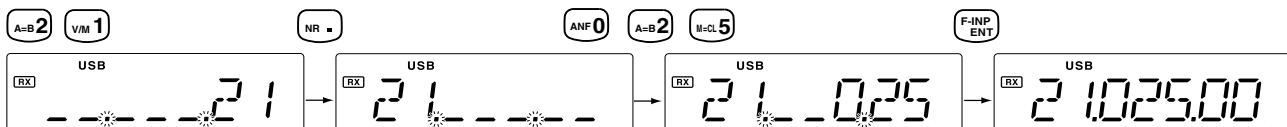

•To set to 706 KHz (0.706 MHz)

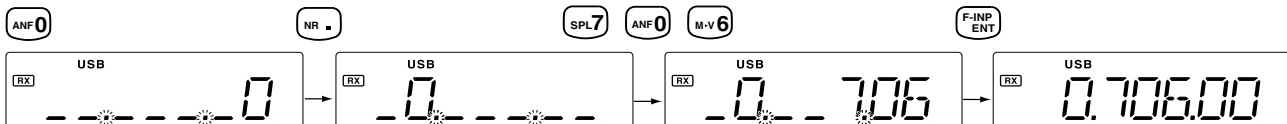

•To set to 7 MHz

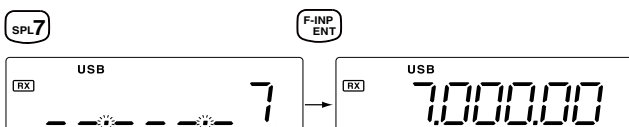

•To change 14.195 to 14.850 MHz

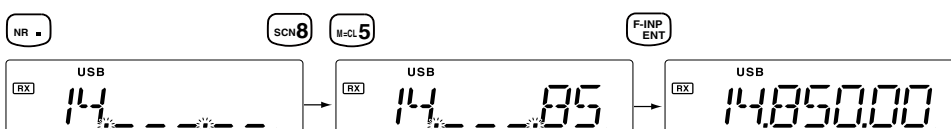

4 FREQUENCY SETTING

◇ Band stacking resister

The band stacking register automatically stores the last frequency and mode used for each band. This is convenient for contest operation, etc. The tables below shows the band stacking register default settings for each band.

BAND	BAND	BAND
1.9 MHz	1.91000 MHz	CW
3.5 MHz	3.55000 MHz	LSB
7 MHz	7.05000 MHz	LSB
10 MHz	10.12000 MHz	CW
14 MHz	14.10000 MHz	USB
General	15.10000 MHz	USB

BAND	BAND	BAND
18 MHz	18.10000 MHz	USB
21 MHz	21.20000 MHz	USB
24 MHz	24.95000 MHz	USB
28 MHz	28.50000 MHz	USB
29 MHz	29.50000 MHz	USB

◇ Band selection

All HF ham bands and a general coverage receiver band are included in the IC-718.

Push [▲ UP]/[▼ DN] to select the desired band.

- Pushing [▲ UP]/[▼ DN] continuously scrolls through the available bands.

Note: For example, if 6.10000 MHz is registered as the General coverage frequency, then the General coverage band automatically positions itself between 3.5 MHz and 7 MHz band.

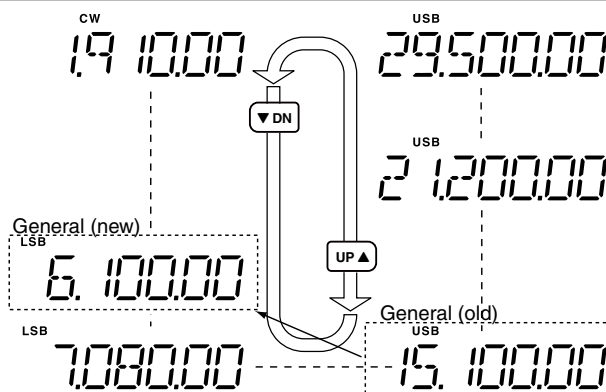

◇ Programmable tuning steps

Programmable tuning steps are available to suit your operating requirements.

These tuning steps are:

- Selectable from 0.1, 1, 5, 9, 10, 100 kHz

- ① Push [TS], the programmable tuning step indicator, "▼", then appears above the 1 kHz.
 - Rotating the tuning dial changes the frequency according to the set tuning step.
- ② Push [TS] for 2 sec. while the programmable tuning step indicator appears to enter the tuning step set mode.
- ③ Rotate the tuning dial to set the desired tuning step.
- ④ Push [TS] to exit the tuning step set mode.
- ⑤ Rotate the tuning dial to change the frequency according to the set tuning step.



Programmable tuning step indicator

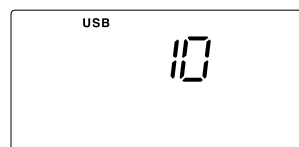

10 KHz tuning steps is selected.

◇ 1 Hz and 10 Hz tuning steps

When the programmable tuning step, “▼,” disappears, rotating the tuning dial changes the frequency in increments of 1 or 10 Hz.

- ① Push [TS] one or more times until the programmable tuning step indicator “▼” disappears.
- ② Push [TS] for 1 sec. to toggle between the 1 and 10 Hz step settings.
 - When the 1 Hz step is selected, the 1 Hz digit appears in the frequency indication; when the 10 Hz step is selected, the 1 Hz digit disappears from the frequency indication.

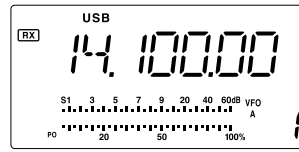

Rotating the tuning dial changes the frequency in 10 Hz steps.

Push  for 1 sec.

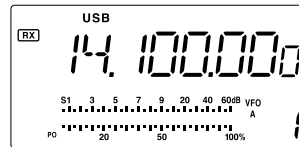

Rotating the tuning dial changes the frequency in 1 Hz steps.

[TS] SWITCH FLOW CHART

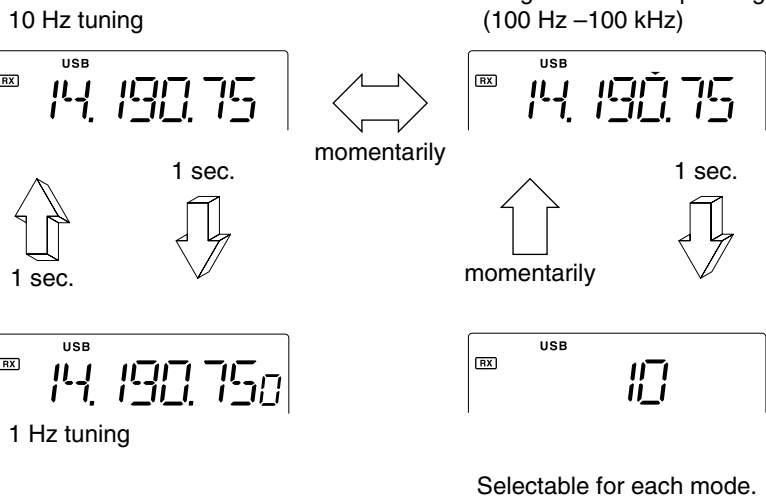

■ Dial lock function

The dial lock function prevents accidental changes caused by the tuning dial. The lock function electronically locks the dial.

Push [LOCK] momentarily to toggle the lock function ON and OFF.

- “LOCK” appears in the function display while the lock function is activated.

“LOCK” appears while the lock function is activated.

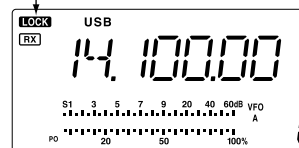

Mode selection

The following modes are available in the IC-718: SSB (LSB/USB), CW, CW REV (CW reverse), RTTY, RTTY REV (RTTY reverse) and AM.

- Push [MODE] one or more times to select desired operation mode.
- Push [MODE] for 1 sec. to toggle between USB and LSB. (SSB mode only)
- Push [MODE] for 1 sec. to toggle between CW and CW reverse or RTTY and RTTY reverse. (CW and RTTY mode only)
- The selected mode is indicated in the function display.

Note: If desired mode cannot be selected, it's use may be inhibited by initial set mode. (p. 44)

OPERATING MODE SELECTION

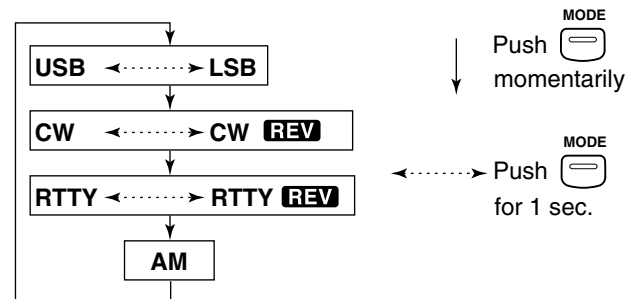

RF gain and Squelch

The IC-718 uses the same control, [RF/SQL], to adjust either the RF gain or the squelch. [RF/SQL] adjusts either the RF gain or the squelch depending on the operating mode selected and the condition of the RF/SQL item in initial set mode (p. 44).

• [RF/SQL] control priority

Set mode setting	USB, LSB, CW, RTTY	AM
rS (RF/SQL) (default)	RF/SQL	RF/SQL
At (AUTO)	RF GAIN	SQL*
Sq (SQL)	SQL*	SQL*

* The RF gain is set to maximum level when the [RF/SQL] is set as [SQL] control.

The *RF (Radio Frequency) gain* is used to adjust the receiver gain.

- Shallow rotation moves the S-meter to the right indicating the signal strength which can be received.

▨ The recommended position for RF gain is the 12 o'clock position since this sets RF gain to the max.

The *SQUELCH* removes noise output from the speaker (closed condition) when no signal is received. The squelch is available for the other modes.

- A segment appears in the S-meter to indicate the S-meter squelch level.

• When set as the [RF/SQL] control

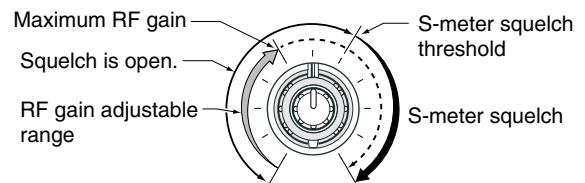

• When set as the [SQL] control

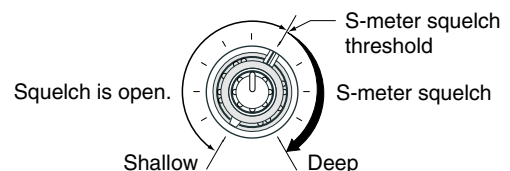

• When set as the [RF] control

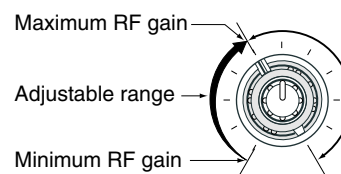

■ Function for receive

◇ IF shift function

The IF shift function electronically narrows the passband frequency of the IF (intermediate frequency) and cuts out higher or lower frequency components of the IF to reject interference. The function shifts the IF frequency up to ± 1.2 KHz in SSB/CW/RTTY modes and up ± 250 Hz in CW-narrow/RTTY narrow modes. The IF shift is not available in AM mode.

IF SHIFT OPERATION EXAMPLE

- Adjust the [SHIFT] control for a minimum interference signal level.
- When IF shift is used, the audio tone may be changed.
- Set the IF shift control to its center position when there is no interference.

Both controls at center position

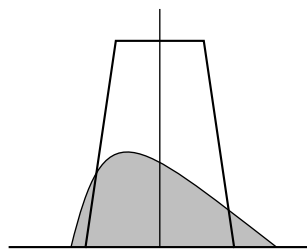
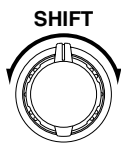

IF center frequency

Cutting a lower passband

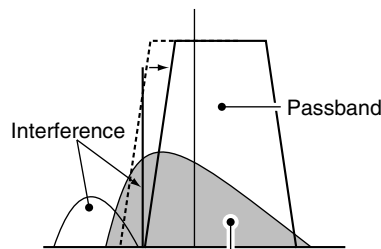
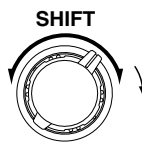

Desired signal

Cutting higher passbands

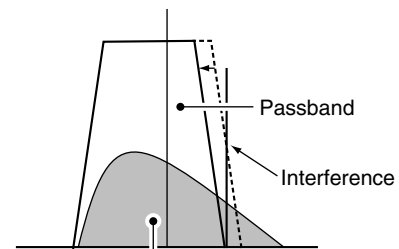
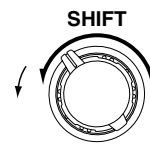

Desire I signal

◇ RIT function

The RIT (Receive Incremental Tuning) function compensates for off-frequencies of communicating stations. The function shifts the receive frequency up to 1.2 KHz without moving the transmit frequency.

- ① Rotate the RIT control to cancel the off-frequencies.
 - "RIT" appears on the display.
 - The transmit frequencies are not shifted.

- ② To cancel the RIT function, rotate the RIT control to the center position.
 - "RIT" disappears.

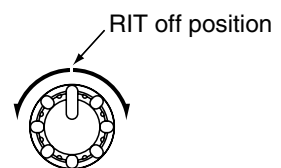

◇ Preamp

The preamp amplifies received signals in the front end circuit to improve the S/N ratio and sensitivity. Turn this function ON when receiving weak signals.

- ➔ Push [P.AMP] to toggle between preamp or turn the preamp OFF.
 - Preamp functions below 1.59999 MHz, but sensitivity may reduce in some cases.

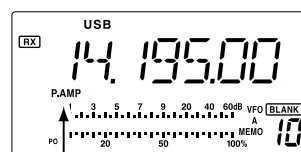

Appears when the preamp ON.

5 RECEIVE AND TRANSMIT

◇ Attenuator

The attenuator prevents desired signals from distorting when very strong signals are near the desired frequency or when very strong electric fields, such as from broadcasting stations, are near your location.

- ➔ Push [ATT] to toggle the 20 dB attenuator function ON and OFF.
 - "ATT" appears when the attenuator is turned ON.

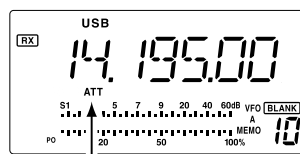

Appears when the attenuator ON.

◇ Noise blanker

The *noise blanker* reduces pulse-type noise such as that generated by automobile ignition systems.

- ① Push the [NB] switch to turn the noise blanker ON or OFF.
- ② Push the [NB] for 1 sec. to enter the noise blanker level setting condition.
- ③ Rotate the tuning dial to adjust the noise blanker level.
- ④ Push [NB] to exit the setting condition.
- ⑤ Push [NB] again to turn the noise blanker function OFF.
 - [NB] indicator disappears.

- When using the noise blanker, received signals may be distorted if they are excessively strong.
- The noise blanker function in AM mode can be deactivated depending on initial set mode setting. (p. 45)

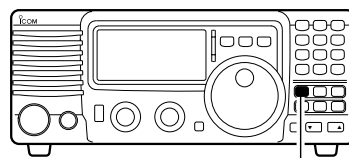

[NB] switch

◇ Peak meter hold

The peak meter hold function freezes the highest displayed bar segment in any meter function for about 0.5 sec. so that you can more easily read the meter. This function can be turned ON and OFF in initial set mode (p. 45).



Initial reception of a signal results in an S-meter reading of 40 dB.



The highest indicated bar remains displayed for 0.5 sec. even when the signal strength decreases.

■ DSP function (Requires an optional UT-106 DSP UNIT)

◇ NR (Noise reduction) function

When an optional UT-106 is installed (DSP appears in the function display), noise reduction function can be used.

The noise reduction function reduces noise components and picks out desired signals which are buried in noise. The received AF signals are converted to digital signals and then the desired signals are separated from the noise.

- ① Push [NR] to turn the noise reduction ON.
 - [NR] indicator appears.

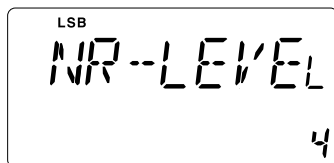

- ② Push [NR] for 1 sec. to enter the noise reduction level setting condition.
- ③ Rotate the tuning dial to adjust the noise reduction level.
- ④ Push [NR] to exit the setting condition.
- ⑤ Push [NR] again to turn the noise reduction OFF.
 - [NR] indicator disappears.

• Noise reduction example

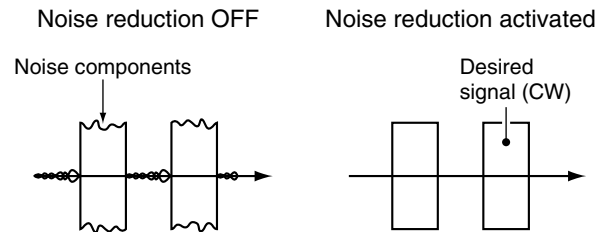

Higher setting of the [NR] level results in audio signal masking or distortion. Set the [NR] level for maximum clarity. The noise reduction function is available in all modes.

◇ ANF (Automatic Notch Filter) function

When an optional UT-106 is installed (DSP appears in the function display), an auto notch function can be used.

The function automatically attenuates more than 3 beat tones, tuning signals, etc., even if they are moving.

/// The auto notch functions in SSB mode only.

- ① Select SSB mode.
- ② Push [ANF] to turn the auto notch function ON.
 - [ANF] indicator appears.
- ③ Push [ANF] again to cancel the function.
 - [ANF] indicator disappears.

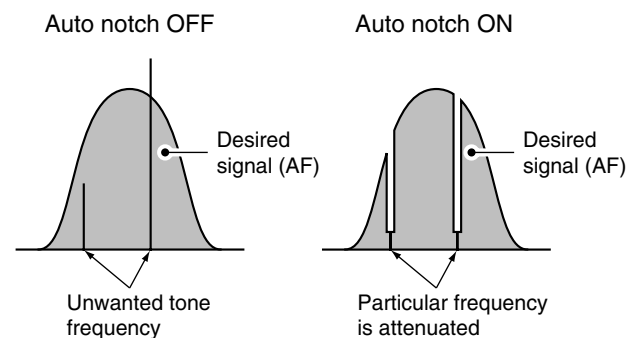

Filter selection

The filter selection switches the IF passband width as shown in the table at right.

The filter selection is automatically memorized in each mode.

- ① Select the desired mode with the mode switches.
- ② Push [FIL] one or more times to select the desired filter combination.
 - **N** or **W** does not appear while in normal IF filter mode.
 - **W** appears when the wide IF filter is selected.
 - **N** appears when the narrow IF filter is selected.

When an optional filter is installed, set the optional filter in initial set mode. An optional filter is not selected by default.

Optional filter variations

Name	Band width	Mode
FL-52A	500 Hz/-6dB	CW/RTTY-N
FL-53A	250 Hz/-6dB	CW/RTTY-N
FL-96	2.8 KHz/-6dB	SSB-W
FL-222	1.8 KHz/-6dB	SSB-N
FL-257	3.3 KHz/-6dB	SSB-W

Filter construction

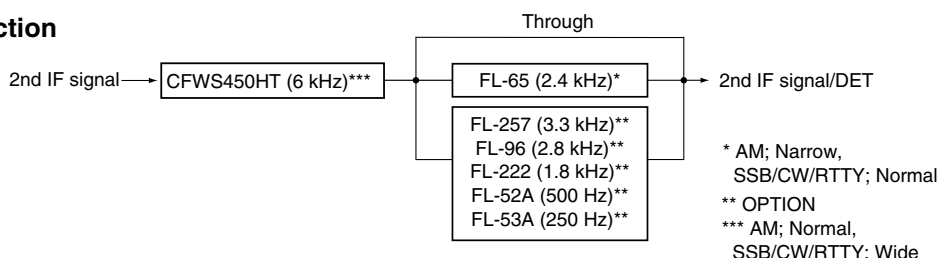

Filter selection table

		no	FL-52A	FL-53A	FL-96	FL-222	FL-257	
SSB	WIDE	6 K*	6 K*	6 K*	6 K*	6 K*	6 K*	
					2.8 K		3.3 K	
	NORMAL	2.4 K	2.4 K	2.4 K	2.4 K	2.4 K	2.4 K	
	NARROW	/	500*	250*	/	1.8 K	/	
CW	WIDE	6 K*	6 K*	6 K*	6 K*	6 K*	6 K*	
					2.8 K		3.3 K	
	NORMAL	2.4 K	2.4 K	2.4 K	2.4 K	2.4 K	2.4 K	
	NARROW	/	500	250	/	1.8 K	/	
RTTY	WIDE	6 K*	6 K*	6 K*	6 K*	6 K*	6 K*	
					2.8 K		3.3 K	
	NORMAL	2.4 K	2.4 K	2.4 K	2.4 K	2.4 K	2.4 K	
	NARROW	/	500	250	/	1.8 K	/	
AM	WIDE	/	/	/	/	/	/	
	NORMAL	6 K	6 K	6 K	6 K	6 K	6 K	
	NARROW	2.4 K	2.4 K	2.4 K	2.4 K	2.4 K	2.4 K	
		500*	250*	2.8 K*	1.8 K*	3.3 K*		(Hz)

Note: *This selection can be used when the expanded filter selection function is turned on in the initial set mode. (see right)

Filter setting

When an optional filter is installed, set the optional filters in initial set mode. Optional filters are not selected by default. (p. 47)

Optional filter setting

- ① While pushing and holding [SET], push [POWER] to enter initial set mode.
- ② Push [UP ▲] or [▼ DN] one or more times until "FIL" appears on the display.
- ③ Rotate the tuning dial to select the installed filter.
 - "no," "52A," "53A," "96," "222" and "257" indicate no optional filter, FL-52A, FL-53A, FL-96, FL-222 and FL-257, indicate respectively for 455 kHz IF filter selection.
- ④ Push [PWR] to exit initial set mode.

Expanded filter selection

The selectable filter combinations can be expanded by setting the expanded filter selection to ON. Then extra wide or narrow filter can be selected on desired mode.

- ① While pushing and holding [SET], push [PWR] to enter initial set mode.
- ② Push [UP ▲] or [▼ DN] one or more times until "EXP FIL" appears.
- ③ Rotate the tuning dial to turn the expanded filter selection 'on'.
 - If 'on' is selected, the expanded filter selection can be used.

Wide/narrow filter selecting

- ④ Push [UP ▲] one or more times until "WIDE **" or "NAR **" appears on the display.
- ⑤ Push [MODE] one or more times to select the desired mode.
- ⑥ Rotate the tuning dial to select a filter.
- ⑦ Repeat steps ⑤ and ⑥ to select IF filters for other modes, if desired.
 - The filter combinations are stored depending on operating modes.
- ⑧ Push [POWER] to exit initial set mode.

Optional filter selection

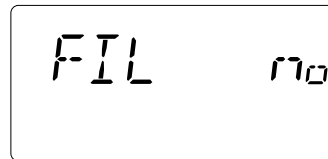

Expanded filter selection "on"

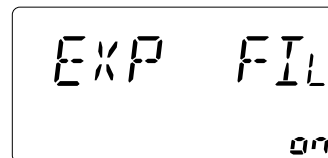

Wide filter setting

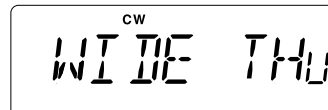

Narrow filter setting

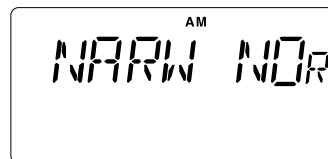

Wide filter setting table

	no	FL-52A	FL-53A	FL-96	FL-222	FL-257
SSB	no	no	no	96 (2.8 K)	no	257(3.3 k)
	THU (6 K)	THU (6 K)	THU (6 K)	THU (6 K)	THU (6 K)	THU (6 K)
CW	no	no	no	96 (2.8 K)	no	257(3.3 k)
	THU (6 K)	THU (6 K)	THU (6 K)	THU (6 K)	THU (6 K)	THU (6 K)
RTTY	no	no	no	96 (2.8 K)	no	257(3.3 k)
	THU (6 K)	THU (6 K)	THU (6 K)	THU (6 K)	THU (6 K)	THU (6 K)
AM	---	---	---	---	---	---

: default

Narrow filter setting table

	no	FL-52A	FL-53A	FL-96	FL-222	FL-257
SSB	---	no	no	---	222 (1.8 K)	---
		52A (500)	53A (250)			
CW	---	52A (500)	53A (250)	---	222 (1.8 K)	---
RTTY	---	52A (500)	53A (250)	---	222 (1.8 K)	---
AM	NOR (2.4 K)	NOR (2.4 K)	NOR (2.4 K)	NOR (2.4 K)	NOR (2.4 K)	NOR (2.4 K)
		52A (500)	53A (250)	96 (2.8 K)	222 (1.8 K)	257 (3.3 K)

: default

■ Function for transmit

◇ Output power and microphone gain

• Setting output power

- ① Push [SET] for 1 sec. to select quick set mode.
- ② Push [▲ UP]/[▼ DN] one or more times to select "RF Power".
- ③ Rotate the main dial to select the desired output.
 - Output power is displayed in 101 steps (L, 1–99 and H) but is continuously selectable.

• Available power

- SSB/CW/RTTY: 2 (or less) –100 W
- AM: 2 (or less) –40 W*
- *Carrier power

• Setting microphone gain

Microphone gain must be adjusted properly so that your signal does not distort when transmitted.

- ① Select SSB or another phone mode.
- ② Push [SET] for 1 sec. to enter the quick set mode.
- ③ Push [▲ UP]/[▼ DN] one or more times to select "MIC GAIN".
- ④ When speaking into the microphone adjust the mic gain so that the ALC meter does not peak past the ALC zone.
- ⑤ Push [SET] to exit quick set mode.

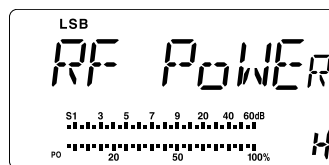

Maximum output power is selected.

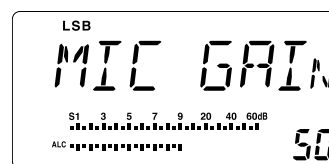

Microphone gain is set to 50.

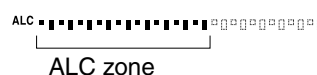

◇ Meter function

The bar meter in the function display acts as an S-meter (for relative signal strength) during receive and can be selected for one of three functions during transmit.

- Push [SET] one or more times to select the PO, ALC and SWR meter mode.

DISPLAY INDICATION	MEASUREMENT
Po	Indicates the relative RF output power.
ALC	Indicates the ALC level. When the meter movement shows the input signal level exceeds the allowable level, the ALC limits the RF power. In such cases, reduce the microphone gain (see above).
SWR	Indicates the SWR over the transmission line.

◇ Microphone compressor

IC-718 has a built-in, low distortion Mic compressor circuit. This circuit increases your average talk power in SSB mode and is especially useful for DX'ing when the receiving station is having difficulty copying your signal.

- ① Selecting USB or LSB mode.
- ② Select the mic gain display in quick set mode.
 - Push [SET] for 1 sec. to select quick set mode.
 - Push [▲ UP]/[▼ DN] one or more times to select "MIC GAIN".
- ③ Adjust the mic gain by rotating the main [DIAL].
 - While transmitting at your normal voice level, the ALC meter should read at about the middle of the ALC zone.
 - Be sure the mic gain is in the range of 20 to 50.
- ④ Push [SET] to exit the quick set mode.
- ⑤ Push [COMP] to turn mic compressor ON.
- ⑥ Push [SET] one or more times to select the ALC meter.
- ⑦ While speaking into the microphone at a normal voice level, confirm the ALC level so that the ALC meter peak does not past the ALC zone.
 - If the ALC meter peak past the ALC zone, re-adjust the mic. gain.

Note: When the ALC meter peaks above the ALC zone, your transmitted voice may be distorted.

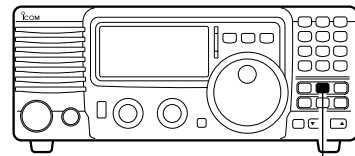

[COMP] switch



Adjust [MIC GAIN] so that the ALC meter reads within the ALC zone.

◇ VOX operation

The VOX (Voice-operated Transmission) function toggles between transmit and receive with your voice. This function provides an opportunity to input log entries into your computer, etc. while operating.

- ① Push [VOX] to turn the function ON.
- ② Select "VOX Gain" in quick set mode.
 - Push [SET] for 1 sec. to select quick set mode.
 - Push [▲ UP]/[▼ DN] one or more times to select "VOX GAIN"
- ③ While speaking into the microphone, adjust [VOX GAIN] until the transceiver is transmitting.
- ④ Select "VOX Delay" in quick set mode.
 - Push [▲ UP]/[▼ DN] one or more times to select "VOX Delay"
- ⑤ While speaking into the microphone, adjust [VOX DELAY] as desired.
- ⑥ Select "ANTI-VOX" in quick set mode.
 - Push [▲ UP]/[▼ DN] one or more times to select "ANTI-VOX"
- ⑦ If the receive audio from the speaker toggles the transceiver to transmit during receive, adjust the "ANTI-VOX" to the point where it has no effect.
- ⑧ Push [SET] to exit the quick set mode.

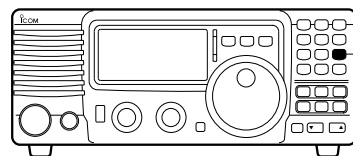

[VOX] switch

◇ Optional AT-180 AUTOMATIC ANTENNA TUNER operation

The AT-180 automatic antenna tuner matches the IC-718 to the connected antenna automatically. Once the tuner matches an antenna, the variable capacitor angles are memorized as a preset point for each frequency range (100 kHz steps). Therefore, when you change the frequency range, the variable capacitors are automatically preset to the memorized point.

CAUTION: NEVER transmit with the tuner ON when no antenna is connected. This will be damage both the transceiver and the antenna tuner.

DO NOT! connect the AT-180 and AH-4 at the same time. Both turners will not be function correctly.

TUNER OPERATION

• Tuner type setting (p.46)

- ① Push [PWR] for 1 sec. to turn power OFF.
 - ② While pushing and holding [SET], push [PWR] to turn power ON.
 - ③ Push [UP ▲] or [▼ DN] one or more times to select [TUNER].
 - ④ Rotate the main dial to select "18".
 - AT-180 AUTOMATIC ANTENNA TUNER is selected.
- /// **NOTE: NEVER** select "4" (AH-4 AUTOMATIC ANTENNA TUNER), otherwise the transceiver transmits automatically when turning the power ON. Push [TUNER] to cancel unexpected transmission. Then, re-select the tuner type correctly.
- ⑥ Push [PWR] for 1 sec. to turn power OFF.
 - ⑦ Push [PWR] to turn power ON again.

• AUTO TUNE:

Push [TUNER] to turn the tuner ON. The antenna is tuned automatically during transmission when the antenna SWR is higher than 1.5:1.

- When the tuner is OFF, "[TUNE]" goes out.

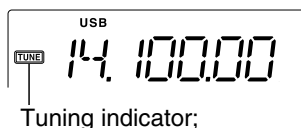
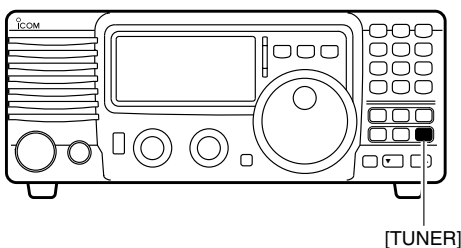

Tuning indicator;

• MANUAL TUNING

During SSB operation on HF bands at low voice levels, the AT-180 may not be tuned correctly. In such cases, manual tuning is helpful.

Push and hold [TUNER] for 1 sec. to start manual tuning.

- CW mode is selected, a side tone is emitted, and "[TUNE]" blinks; then, the previous mode is selected.

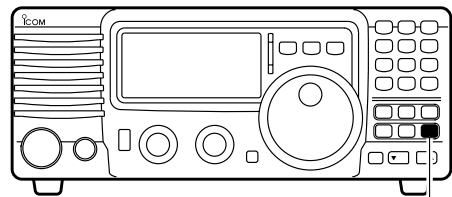

[TUNER]

Push and hold 1 sec. to start manual tuning.

If the tuner cannot reduce the SWR to less than 1.5:1 after 20 sec. of tuning, "[TUNE]" goes out. In this case, check the following:

- the antenna connection and feedline
- the antenna SWR (p. 26; meter function)

• Through inhibit

The AT-180 has a through inhibit condition. When selecting this condition, the tuner can be used at poor SWR's. In this case, automatic tuning in the HF bands activates only when exceeding SWR 3:1. Therefore, manual tuning is necessary each time you change the frequency. Although termed "through inhibit," the tuner will be "through" if the SWR is higher than 3:1 after tuning.

CONVENIENT

• Tuner sensitive condition

If you require critical tuning at any time during transmission, select the tuner sensitive condition. See p. 51 for selection.

• Automatic tuner start

If you want to turn OFF the tuner under conditions of VSWR 1.5:1 or less, use "automatic tuner on" and turn the tuner OFF. See p. 46 for turning the function ON and OFF.

◇ Optional AH-4 AUTOMATIC ANTENNA TUNER operation

The AH-4 matches the IC-718 to a long wire antenna more than 7 m/23 ft long (3.5 MHz and above).

- See p. 14 for connection.
- See the AH-4 instruction manual for AH-4 installation and antenna connection details.

AH-4 setting example:

For mobile operation

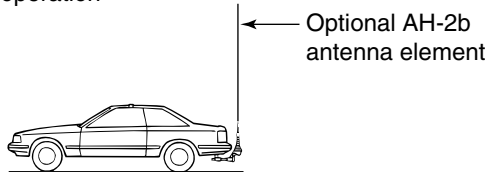

For outdoor operation

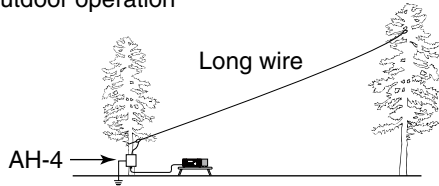

⚠ WARNING: HIGH VOLTAGE!
NEVER touch the antenna element while tuning or transmitting.

NEVER operate the AH-4 without an antenna wire. The tuner and transceiver will be damaged.

NEVER operate the AH-4 when it is ungrounded.

Transmitting before tuning may damage the transceiver. Note that the AH-4 cannot tune when using a $1/2 \lambda$ long wire or multiple of the operating frequency.

TUNER OPERATION

Tuning is required for each frequency. **Be sure** to re-tune the antenna before transmitting when you change the frequency—even slightly.

• Tuner type setting (p.46)

- ① Push [PWR] for 1 sec. to turn power OFF.
- ② While pushing and holding [SET], push [PWR] to turn power ON.
- ③ Push [UP ▲] or [▼ DN] one or more times to select [TUNER].
- ④ Rotate the main dial to select “4”.
 - AH-4 AUTOMATIC ANTENNA TUNER is selected.
- ⑥ Push [PWR] for 1 sec. to turn power OFF.
- ⑦ Push [PWR] to turn power ON again.

• MANUAL TUNING

- ① Set the desired frequency in an HF band.
 - The IC-718 will not transmit outside of the ham bands, the AH-4 tuner will tune all frequencies 3.5 to 30 MHz.
- ② Push and hold [TUNER] for 1 sec.
 - “[TUNE]” blinks and “CW” appears while tuning.

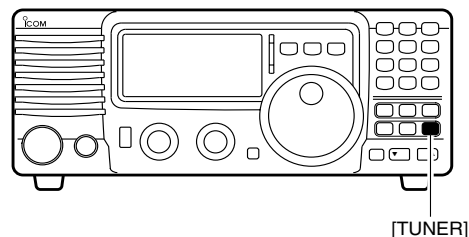

- ③ “[TUNE]” lights constantly when tuning is complete.
 - When the connected wire cannot be tuned, the “[TUNE]” goes out, the AH-4 is bypassed and the antenna wire is connected to the antenna connector on the transceiver directly.
- ④ To bypass the AH-4 manually, push [TUNER].

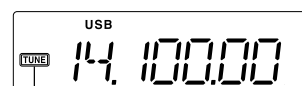

Tuning indicator;
Blinks: Tuning now
Appears: Tune is completed
Disappears: Tune is not completed

CONVENIENT

• PTT tune function

The AH-4 is always tuned when the PTT is pushed after the frequency is changed (more than 1%). This function removes the “push and hold [TUNER]” operation and activates first transmission on the new frequency. This function is turned ON in initial set mode (p. 46).

■ Split frequency operation

Split frequency operation allows you to transmit and receive on two different frequencies. Split frequency operation uses two frequencies, one in VFO A and the other in VFO B.

Following is an example of setting 7.057 MHz, CW mode in VFO A (for receive) and 7.025 MHz, CW mode in VFO B (for transmit).

- ① Select VFO B and set the frequency to 7.025 MHz/ CW.
- ② Push [A/B] to select VFO A and set the frequency to 7.057 MHz/CW.
- ③ Push [SPL] to turn the split frequency operation ON.
 - Split operation is now set for receive 7.057 MHz/CW and transmit 7.025 MHz/CW.
 - To change the receive frequency, rotate the main dial, to change the transmit frequency, rotate the main dial during transmit mode.

To exchange the transmit and receive frequencies,

push [A/B].

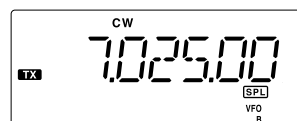
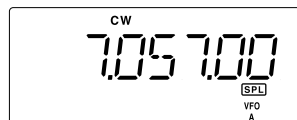

■ SWR

The IC-718 has a built-in circuit of measuring antenna SWR—no external equipment or special adjustments are necessary.

◇ Measuring SWR

- ① Confirm that the output power is over 30 W.
- ② Push [SET] one or more times to select the SWR meter.
- ③ Push [MODE] one or more times to select CW or RTTY operation.
 - Key down or push [PTT] to transmit; then read the actual SWR from the meter:
 - ≤ 1.5 well matched antenna
 - ≥ 1.5 check antenna or cable connection, etc.

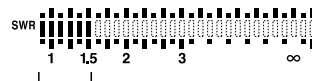

The best match is in this range.

■ Function for CW

◇ Connection for CW

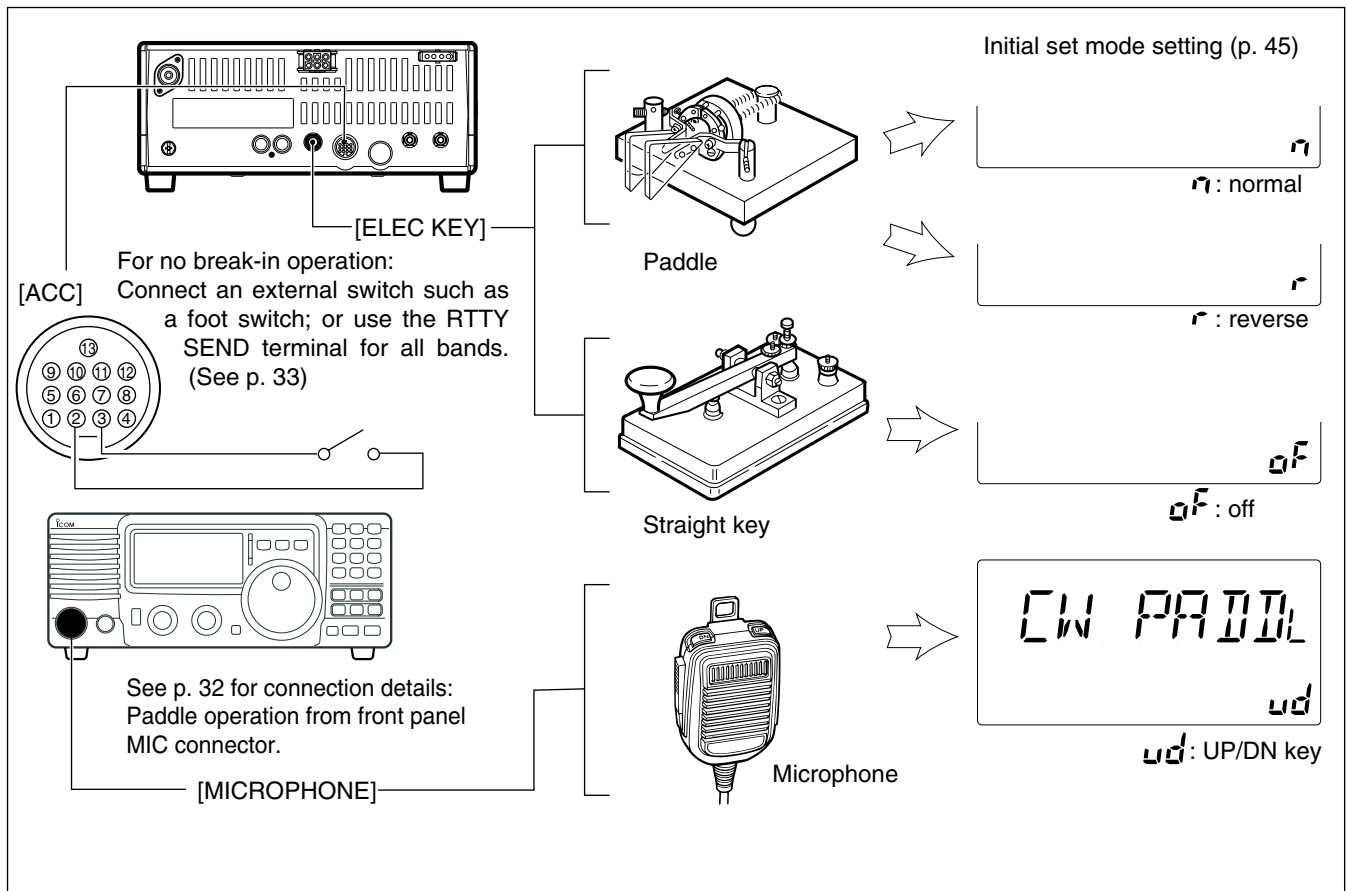

◇ CW operation

- ① Connect a paddle or straight key as above.
- ② Select CW (or CW-REV) mode with [MODE].
- ③ Set CW break-in operation as semi break-in, full break-in or OFF. (See p. 42)
 - Push [SET] for 1 sec. to enter quick set mode.
 - Push [▲ UP]/[▼ DN] one or more times until "BK-IN" appears, then rotate the main dial to select the desired condition:
FL: full break-in
SE: semi break-in
oF: no break-in
- ④ Set the CW delay time when semi break-in operation is selected. (See p. 43)
 - Push [SET] for 1 sec. to enter quick set mode; push [▲ UP]/[▼ DN] one or more times until "BK-DELAY" appears, then rotate the main dial to set the desired delay time.

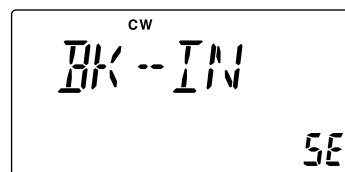

CW mode and semi break-in operation is selected.

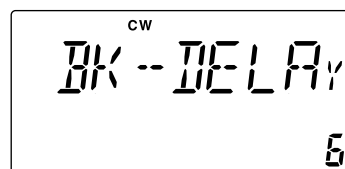

Delay time of 6 dots is selected in quick set mode for semi break-in operation.

5 RECEIVE AND TRANSMIT

◇ CW pitch control

The received CW audio pitch and monitored CW audio pitch can be adjusted to suit your preferences (300 to 900 Hz) without changing the operating frequency.

- ① Push [SET] for 1 sec. to enter quick set mode.
- ② Push [▲ UP]/[▼ DN] one or more times until "CW PITCH" appears, then rotate the main dial to set the desired pitch.

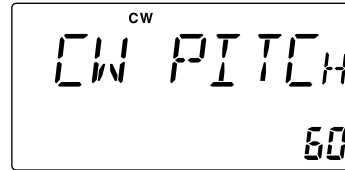

This shows the default setting for the CW pitch control (600 Hz).

◇ CW reverse mode

The CW-R (CW Reverse) mode receives CW signals with a reverse side CW carrier point like that of LSB and USB modes. Use this mode when interference signals are near the desired signal and you want to change the interference tone.

- ① Push [MODE] one or more times to select CW mode.
- ② Push [MODE] for 1 sec. to toggle between CW and CW-R modes.

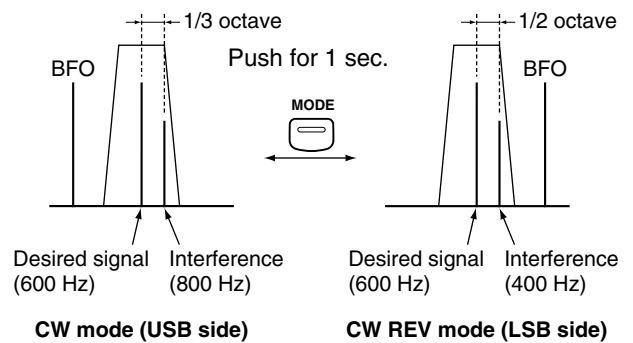

◇ Electronic CW keyer

The IC-718 has an electronic keyer. Both keying speed and weight (the ratio of dot : space : dash) can be set in quick set mode.

• Setting the electronic keyer

- ① Push [MODE] one or more times to select CW mode.
- ② While pushing and holding [SET], push [POWER] to enter initial set mode.
- ③ Push [▲ UP]/[▼ DN] one or more times until "CW PADDL" appears, then rotate the main dial to select the paddle type.
 - When "ud" is selected, the up/down switches on the microphone can be used as a paddle.
 - When using up/down switches as a paddle, squeeze keying function is not available.
- ④ Push [▲ UP]/[▼ DN] one or more times until "KEY RAT" appears, then rotate the main dial to select the desired weight.
 - Key weight can be selected from 2.8 to 4.5.
- ⑤ Push [▲ UP]/[▼ DN] one or more times until "KEY SPD" appears, then rotate the main dial to select the desired weight.
 - Key weight can be selected from 6 to 60.

Paddle operation from front panel MIC connector

Connect a CW paddle as at right to operate an electronic keyer from the front panel MIC connector.

KEYING WEIGHT EXAMPLE: morse code "K"

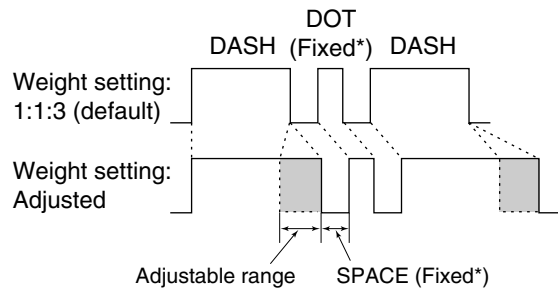

*SPACE and DOT length can be adjusted with "KEY SPD" in the quick set mode only.

Paddle operation

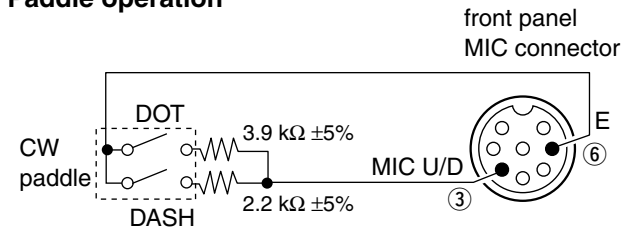

- This function is available from the front panel mic connector only.
- Be sure to select item "n", "r", or "oF" in CW PADDL in initial set mode.
- Connect straight key to "DOT" side.

■ **Function for RTTY**

◇ **Connection for RTTY(FSK)**

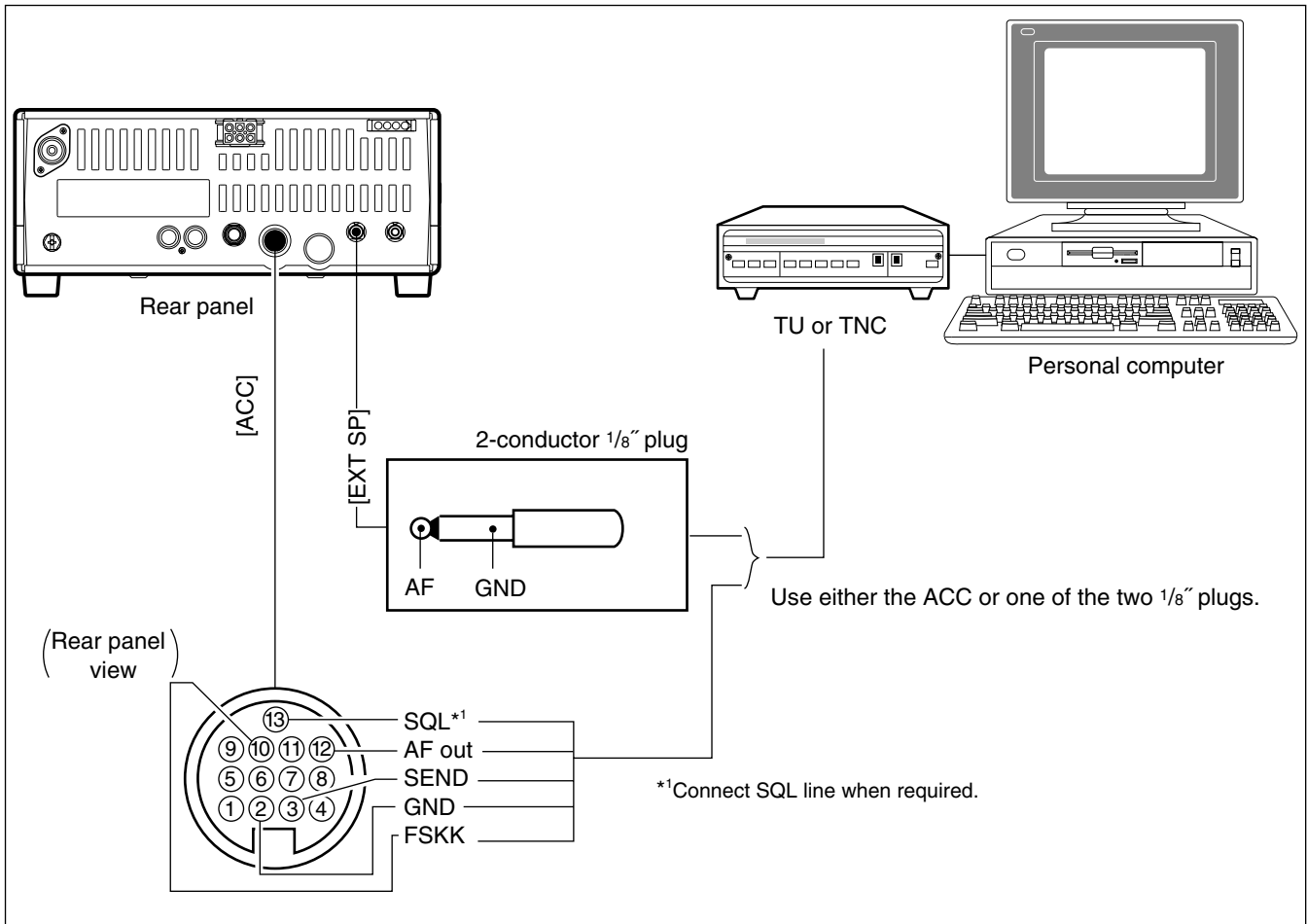

◇ **Connection for AFSK**

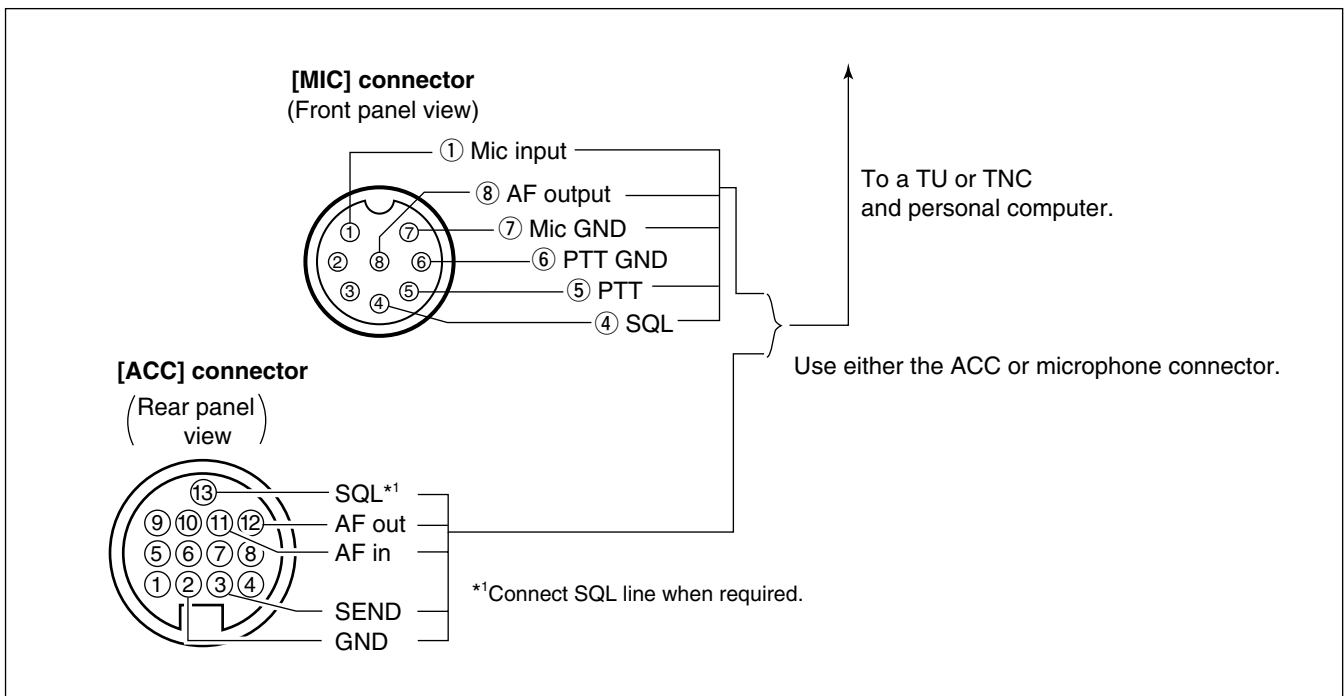

◇ RTTY (FSK) operation

- ① Connect a terminal unit as at p. 34.
- ② Select RTTY (or RTTY-R) mode with [MODE].
- ③ Select the desired FSK tone and shift frequencies as below.
- ④ Set the desired frequency with the main dial.
- ⑤ Operate the connected PC or TNC (TU).



RTTY mode is selected.

PRESETTING FOR RTTY

• Tone frequency

- ① Push [SET] for 1 sec. to enter quick set mode.
- ② Push [▲ UP]/[▼ DN] one or more times until "TON 2125" appears, then rotate the main dial to select the desired tone frequency.

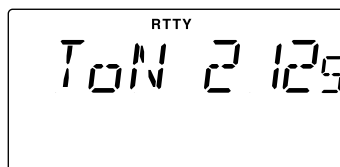

RTTY mark frequency is set to 2125 Hz. 2125, 1615 and 1275 Hz are available.

• Sift frequency

- ① Push [SET] for 1 sec. to enter quick set mode.
- ② Push [▲ UP]/[▼ DN] one or more times until "SIFT 170" appears, then rotate the main dial to select the desired tone frequency.



RTTY sift frequency is set to 850 Hz. 850, 425, 200 and 170 Hz are available.

• RTTY reverse mode

Received characters are occasionally garbled when the receive signal is reversed between MARK and SPACE. This reversal can be caused by incorrect TNC connections, settings, commands, etc.

To receive a reversed RTTY signal correctly, select RTTY-R (RTTY reverse) mode.

- Push [MODE] for 1 sec. to select RTTY-R (RTTY reverse) mode.

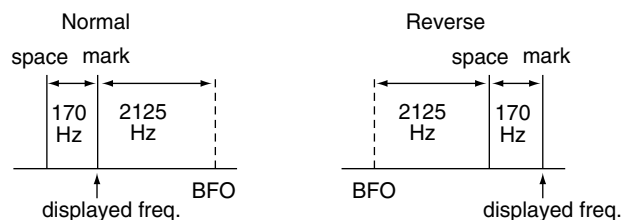

◇ RTTY (AFSK) operation

- ① Connect a terminal unit as p. 33.
- ② Select SSB (LSB) mode with [MODE].
 - Generally, LSB is used on the HF bands.
- ③ Select the desired FSK tone/shift frequencies and keying polarity the same way as FSK operation.
- ④ Set the desired frequency with the main dial.
- ⑤ Operate the connected PC or TNC (TU).

Memory channels

The transceiver has 101 memory channels. The memory mode is very useful for quickly changing to often-used frequencies.

All 101 memory channels are tuneable which means the programmed frequency can be tuned temporarily with the tuning dial, etc. in memory mode.

MEMORY CHANNEL	MEMORY CHANNEL NUMBER	CAPABILITY	TRANSFER TO VFO	OVER-WRITING	CLEAR
Regular memory channels	1-99	One frequency and one mode in each memory channel.	Yes	Yes	Yes
Scan edge memory channels	P1, P2	One frequency and one mode in each memory channel as scan edges for programmed scan.	Yes	Yes	No

Memory channel selection

Using the [UP ▲] or [▼ DN] keys

- Push [V/M] to select memory mode.
 - “MEMO” appears.
- Push [CH] to enter memory CH select mode.
 - “MEMO” blinks.
- Push [UP ▲] or [▼ DN] several times to select the desired memory channel.
 - Push and hold [UP ▲] or [▼ DN] for continuous selection.
- Push [CH] to exit memory CH select mode.
- To return to VFO mode, push [V/M] again.

Using the keypad

- Push [V/M] to select memory mode.
 - “MEMO” appears.
- Push [CH] to enter memory CH select mode.
 - “MEMO” blinks.
- Push [F-INP/ENT], then push the desired memory channel number using the keypad.
- Push [F-INP/ENT] to select the desired memory channel.
- Push [CH] to exit memory CH select mode.

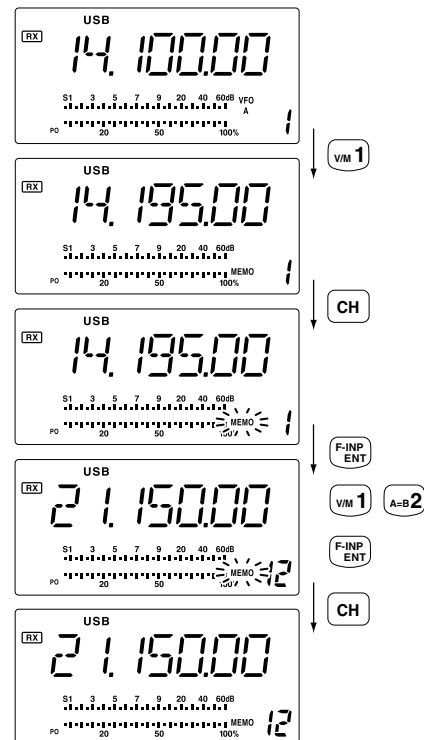
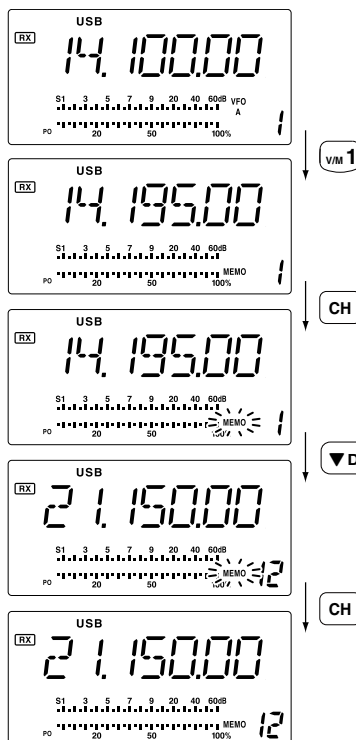

Memory channel programming

Memory channel programming can be performed either in VFO mode or in memory mode.

◇ Programming in VFO mode

- ① Set the desired frequency and operating mode in VFO mode.
- ② Push [CH], then push [UP ▲] or [▼ DN] several times to select the desired memory channel.
 - “MEMO” blinks.
 - “BLANK” appears if the selected memory channel is a blank channel.
- ③ Push [MW] for 1 sec. to program the displayed frequency and operating mode into the memory channel.
- ④ Push [CH] to exit memory channel select mode.

[EXAMPLE]: Programming 7.086 MHz/LSB into memory channel 10.

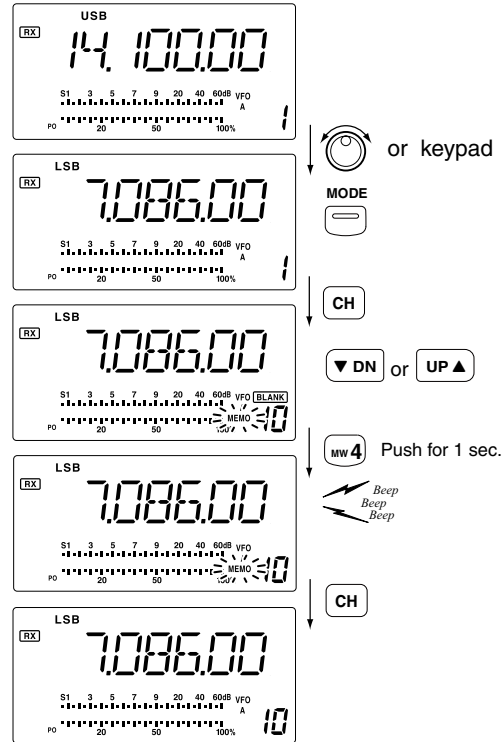

◇ Programming in memory mode

- ① Select the desired memory channel with [UP ▲] or [▼ DN] in memory mode.
 - “BLANK” appears if the selected memory channel is a blank channel (and does not have contents).
- ② Set the desired frequency and operating mode in memory mode.
 - To program a blank channel, use direct frequency entry with the keypad in advance.
- ③ Push [MW] for 1 sec. to program the displayed frequency and operating mode into the memory channel.
 - Preamp setting, attenuator on/off, and AGC setting can also be programmed into a memory channel.

[EXAMPLE]: Programming 21.280 MHz/CW into memory channel 18.

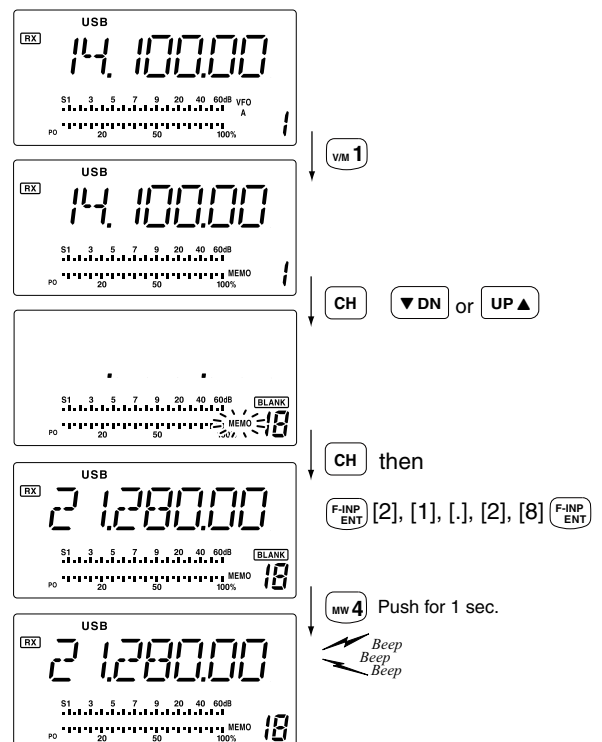

■ Frequency transferring

The frequency and operating mode in a memory channel can be transferred to the VFO.

Frequency transferring can be performed in either VFO mode or memory mode.

◇ Transferring in VFO mode

This is useful for transferring programmed contents to VFO.

- ① Select VFO mode with [V/M].
- ② Push [CH], then select the memory channel to be transferred with [UP ▲] or [▼ DN].
 - “BLANK” appears if the selected memory channel is a blank channel.
- ③ Push [M▶V] for 1 sec. to transfer the frequency and operating mode.
 - Transferred frequency and operating mode appear on the frequency readout.
- ④ Push [CH] to exit memory channel select mode.

TRANSFERRING EXAMPLE IN VFO MODE

Operating frequency : 21.320 MHz/USB (VFO)

Contents of M-ch 12 : 14.180 MHz/CW

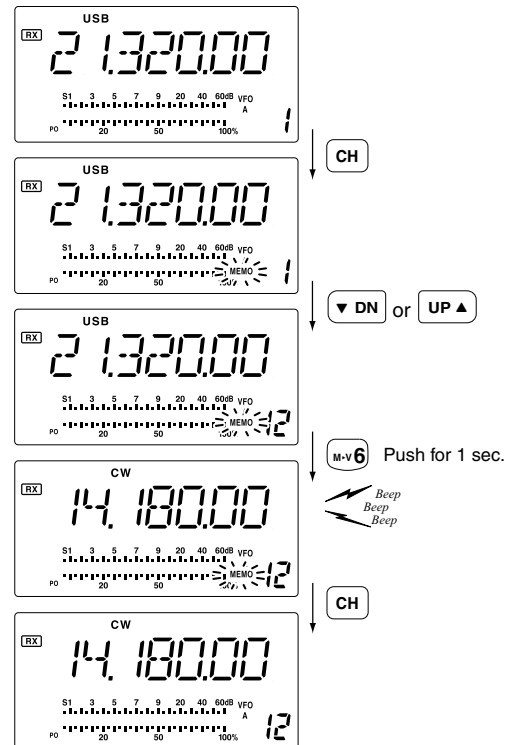

6 MEMORY OPERATION

◇ Transferring in memory mode

This is useful for transferring frequency and operating mode while operating in memory mode.

When you have changed the frequency or operating mode in the selected memory channel:

- **Displayed** frequency and mode are transferred.
- **Programmed** frequency and mode in the memory channel are not transferred, and they remain in the memory channel.

- ① Push [CH], then select the memory channel to be transferred with [UP ▲] or [▼ DN] in memory mode.
 - And, set the frequency or operating mode if required.
- ② Push [M▶V] for 1 sec. to transfer the frequency and operating mode.
 - Displayed frequency and operating mode are transferred to the VFO.
- ③ To return to VFO mode, push [V/M] momentarily.

TRANSFERRING EXAMPLE IN MEMORY MODE

Operating frequency : 14.020 MHz/CW (M-ch 16)

Contents of M-ch 16 : 14.018 MHz/CW

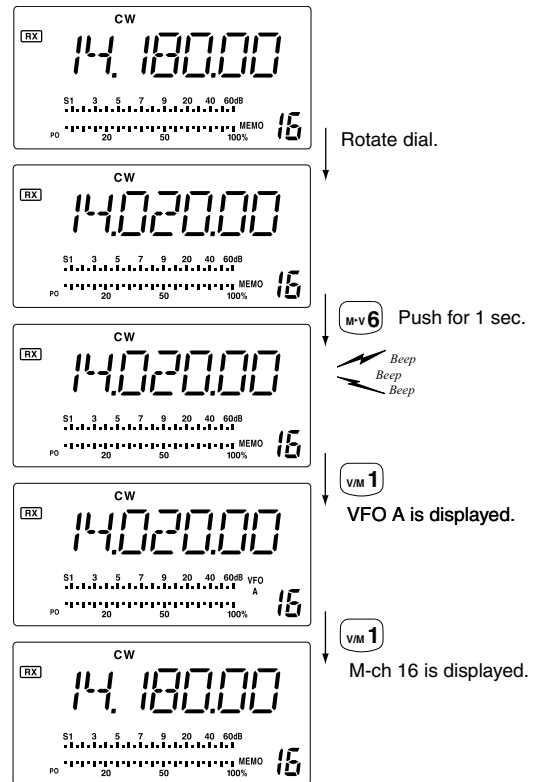

■ Memory clearing

Any unnecessary memory channels can be cleared. The cleared memory channels become blank channels.

- ① Select memory mode with [V/M].
- ② Push [CH], then select the memory channel to be cleared with [UP ▲] or [▼ DN].
- ③ Push [M-CL] for 1 sec. to clear the contents.
 - The programmed frequency and operating mode disappear.
 - "BLANK" appears.
- ④ To clear other memory channels, repeat steps ② and ③.

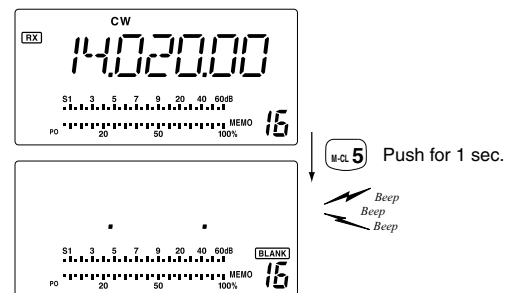

■ Scan types

PROGRAMMED SCAN

Repeatedly scans between two scan edge frequencies (scan edge memory channels P1 and P2).

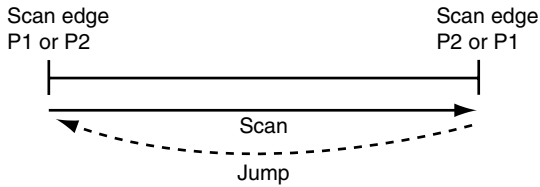

This scan operates in VFO mode.

MEMORY SCAN

Repeatedly scans all programmed memory channels.

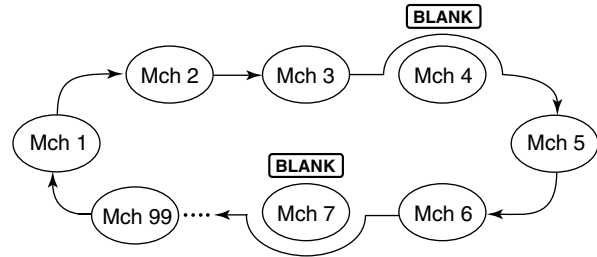

This scan operates in memory mode.

■ Preparation

• Channels

For programmed scan/auto memory write scan:

Program scan edge frequencies into scan edge memory channels P1 and P2.

For memory scan:-

Program 2 or more memory channels except scan edge memory channels.

• Scan resume ON/OFF

You can select the scan to resume or cancel when detecting a signal, in set mode. Scan resume ON/OFF must be set before operating a scan. See p. 45 for ON/OFF setting and scan resume condition details.

• Scan speed

Scan speed can be selected from 2 levels, high or low, in Initial set mode. See p. 45 for details.

• Squelch condition

Scan start with	Programmed scan	Memory scan
Squelch open	The scan continues until it is stopped manually, and does not pause even if it detects signals.	Scan pauses on each channel when the scan resume is ON; not applicable when OFF.
Squelch open closed	Scan stops when detecting a signal. If you set scan resume ON in Initial set mode, the scan pauses for 10 sec. when detecting a signal, then resumes. When a signal disappears while scan is paused, scan resumes 2 sec. later.	

■ Programmed scan operation

- ① Select VFO mode with [V/M].
- ② Select the desired operating mode.
 - The operating mode can also be changed while scanning.
- ③ Set [RF/SQL] open or closed.
 - See previous page for scan condition.
 - If the [RF/SQL] control function is set as RF control, the squelch always opens. See pgs. 15, 20 for details.
- ④ Push [SCAN] to start the programmed scan.
 - "SCAN" appears while scanning.
- ⑤ When the scan detects a signal, the scan stops, pauses or ignores it depending on the resume setting and the squelch condition.
- ⑥ To cancel the scan, push [SCAN].

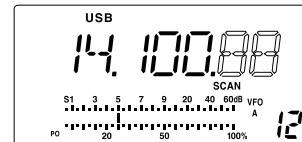

/// If the same frequencies are programmed into the scan edge memory channel P1 and P2, programmed scan does not start.

■ Memory scan operation

- ① Select memory mode with [V/M].
- ② Select the desired operating mode.
 - The operating mode can also be changed while scanning.
- ③ Set [RF/SQL] open or closed.
 - See previous page for scan condition.
 - If the [RF/SQL] control function is set as RF control, the squelch always opens. See pgs. 14, 30 for details.
- ④ Push [SCAN] to start the memory scan.
 - "SCAN" appears while scanning.
- ⑤ When the scan detects a signal, the scan stops, pauses or ignores it depending on the resume setting and the squelch condition.
- ⑥ To cancel the scan, push [SCAN].



/// 2 or more memory channels must be programmed for memory scan to start.

■ General

Set mode is used for programming infrequently changed values or conditions of functions. The IC-718 has 2 separate set modes: *quick set mode* and *initial set mode*.

◇ Quick set mode operation

- ① While power is ON, push [SET] for 1 sec.
 - Quick set mode is selected and one of its items appears.
- ② Push [UP ▲] or [▼ DN] to select the desired item.
- ③ Rotate the main dial to set the values or conditions for the selected item.
- ④ Repeat ② and ③ to set other items.
- ⑤ To exit quick set mode, push [SET] momentarily.

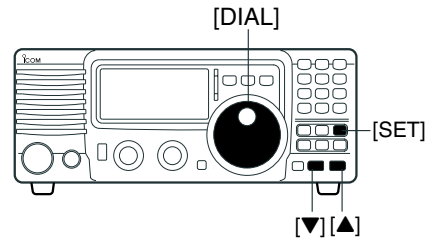

[DISPLAY EXAMPLE: QUICK SET MODE]

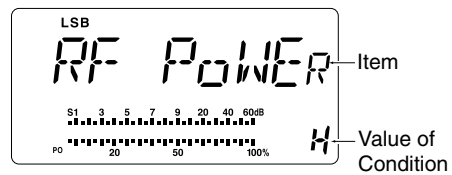

◇ Initial set mode operation

- ① Push [POWER] for 1 sec. to turn power OFF.
- ② While pushing and holding [SET], push [POWER] to turn power ON.
 - Initial set mode is selected and one of its items appears.
- ③ Push [UP ▲] or [▼ DN] to select the desired item.
- ④ Rotate the main dial to set the values or conditions for the selected item.
- ⑤ Repeat ③ and ④ to set other items.
- ⑥ To exit initial set mode, push [PWR] for 1 sec. to turn power OFF.
- ⑦ Push [PWR] to turn power ON again.
 - The conditions selection in initial set mode are now effective.

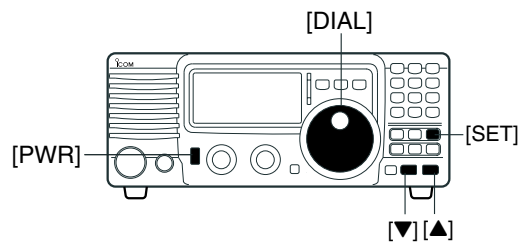

[DISPLAY EXAMPLE: INITIAL SET MODE]

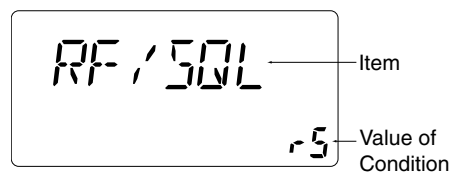

■ Quick set mode items

• RF power

This item adjusts the RF output power. The RF output power can be adjusted from L, 1 to 99 and H for indication, however, it can be adjusted continuously.

•The default is H (maximum power).

Note that while adjusting the output power, the power meter is displayed automatically.

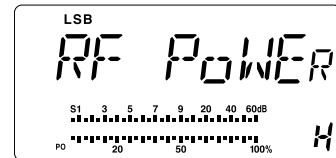

• Mic gain

This item adjusts microphone gain from 0 to 99 and H for indication, however, it can be adjusted continuously.

The default is 50.

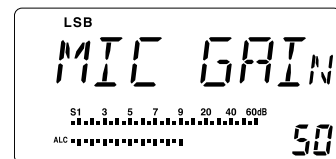

• VOX gain

This item adjusts the VOX gain for the VOX (voice activated transmit) function.

The default is 50.

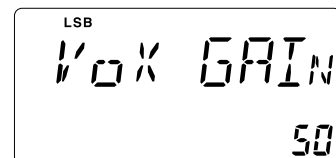

• VOX delay

This item adjusts VOX (voice activated transmit) delay time. The delay time can be adjusted from 0 to 2 sec. in 0.1 sec. units.

The default is 10 (1.0 sec).

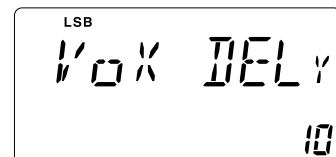

• Anti VOX level

This item adjusts the ANTI-VOX gain for the VOX (voice activated transmit).

The default is 50.

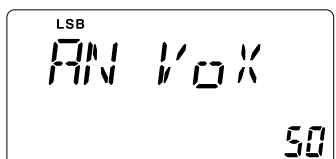

• CW pitch

This item adjusts CW pitch. CW pitch is adjustable from 300 Hz to 900 Hz in 10 Hz steps.

The default is 60 (600 Hz).

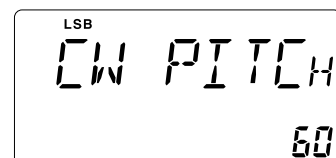

• BK-IN

This item selects break-in type for CW operation. There are three selectable values:

oF : No break-in operation available (default).

SE : Semi break-in operation available.

FL : Full break-in operation available.

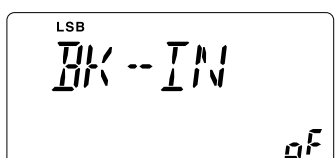

• BK-IN delay

This item adjusts break-in delay time for CW semi break-in operation. The delay time is selectable from 2.0 to 13 (dots).

The default is 7.

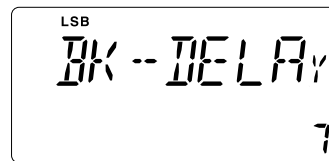

• Key speed

This item adjusts the CW key speed. The key speed can be selected from 6 to 60* wpm.

The default is 20 wpm.

* 40, 44, 47, 50, 52, 54, 56, 57, 59 can not be selected.

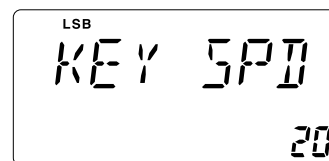

• Key ratio

This item sets the CW key ratio (or weight). The ratio can be selected from 2.8 to 4.5.

The default is 30 (3.0).

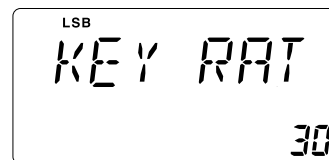

• RTTY mark tone

This item selects RTTY tone. There are 3 selectable values: 1275, 1615 and 2125 Hz.

The default is 2125 Hz.

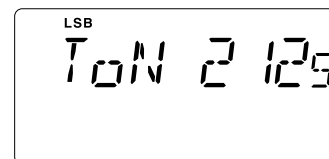

• RTTY shift

This item adjusts RTTY shift. There are 4 selectable values: 170, 200, 425 and 850.

The default is 170 Hz.

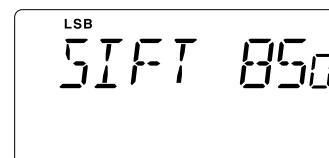

• Dimmer

This item selects LCD back light brightness. There are 3 selectable values: Off, Low and High.

The default is HI (High).

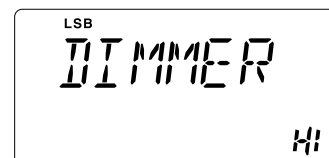

■ Initial set mode items

• Mode select

This item is available in all modes, and allows you to simplify operation by inhibiting the selection of unneeded operating modes during normal operation. For example if you are operating mobile and only plan on using LSB and USB modes, use “MODE SELECTION” to inhibit access to all other modes (CW, RTTY and AM), thereby making selection of LSB and USB quick and easy.

The default is on for all operating modes. To toggle an operating mode on or off, push [MODE] one or more times until the desired mode is displayed. Then rotate the main dial to set on or off.



• RF/SQL VR

The [RF/SQL] control can be set as the RF/squelch control or automatic (acts as squelch in AM modes; as RF in SSB/CW/RTTY modes) or the squelch control. (See p. 20)

The default is rS (RF/squelch).

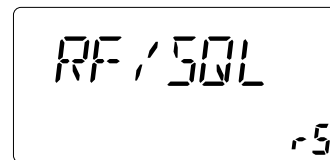

• Beep

A beep sounds each time a switch is pushed to confirm it. This function can be turned OFF for silent operation. The default is on.

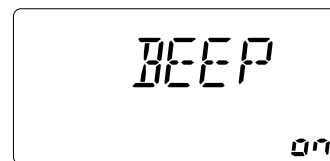

• Beep level

This item adjusts the confirmation beep level. The default is 50.

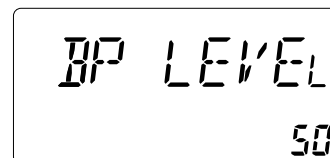

• Band edge beep

A beep sounds when an operating frequency enters or exits a transmit frequency range. This functions independent of the confirmation beep setting. The default is on.

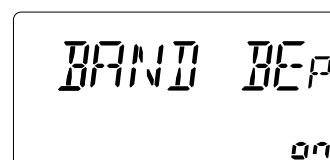

• Side-tone level

This item adjusts the CW side-tone level. The default is 30.

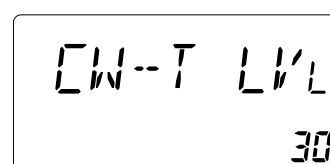

• Meter peak hold

This item selects meter peak hold function on or off.
The default is on.

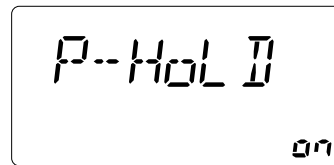

• Scan speed

This item sets the rate at which channels or frequencies are scanned during scan operations. High or Low can be selected.

The default is HI (High).

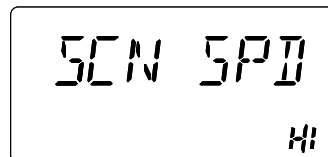

• Scan resume

This item sets the scan resume function ON or OFF.

ON: scan resumes 10 sec. after stopping on a signal (or 2 sec. after a signal disappears); OFF: scan does not resume after stopping on a signal. For the priority watch, setting to OFF pauses the watch until the signal disappears and scan resumes.

The default is on.

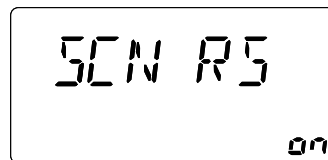

• AM Noise blanker

When this item is set to ON, the noise blanker function is available on AM mode. This is useful when communicating in AM mode (the noise blanker function should not be used when listening to regular AM broadcasts as it may degrade the receive audio).

The default is on.

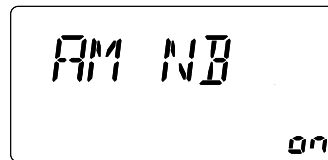

• Auto TS

This item sets auto tuning speed. The tuning dial normally changes the frequency 2.5 KHz/revolution in 10 Hz tuning step. When auto tuning step is turned on this increases to 50 KHz/revolution in 50 Hz tuning step during quick rotation of the dial.

The default is on.

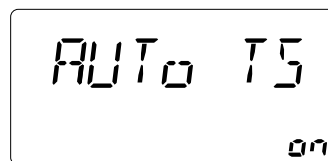

• Key type

This item adjusts the CW paddle type. Four selections are available.

- n : normal (for electronic keyer use)
- r : reverse (for electronic keyer use)
- oF: Turns OFF the electronic keyer (for straight key use)
- ud : For using the microphone's [UP]/[DN] keys instead of the paddle.

The default is n (normal).

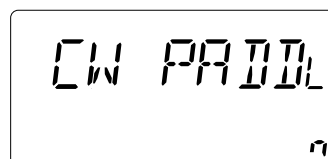

8 SET MODE

• Tuner type

This item selects optional antenna tuner type. Three selections are available.

- no : No optional tuner connected.
 - 4 : The optional AH-4 antenna tuner is connected.
 - 18 : The optional AT-180 antenna tuner is connected
- The default is no.



• Auto tune

The optional AT-180 ANTENNA TUNER has an automatic start capability which starts tuning if the SWR is higher than 1.5—3.

When “off” is selected, the tuner remains OFF even when the SWR is poor (1.5—3). When “on” is selected, automatic tune starts even when the tuner is turned OFF. The default is oF (OFF).

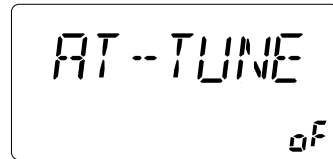

• PTT tune

When an optional AH-4 or AT-180 AUTOMATIC ANTENNA TUNER is connected, tuning can be started automatically at the moment the PTT is pushed. The default is oF (OFF).

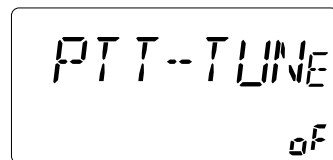

• Speech language

When an optional UT-102 VOICE SYNTHESIZER UNIT is installed, you can select between English and Japanese as the language. The default is En (English).

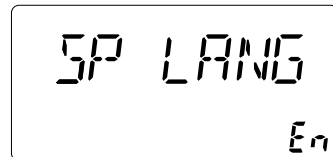

• Speech speed

When an optional UT-102 VOICE SYNTHESIZER UNIT is installed, you can select faster or slower synthesizer output. The default is HI (High).

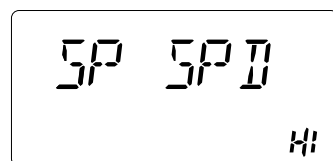

• Speech S-meter level

When an optional UT-102 is installed, the synthesizer can be set to read the frequency/mode only (OFF), or both the frequency/mode and S-meter level (ON). The default is on.

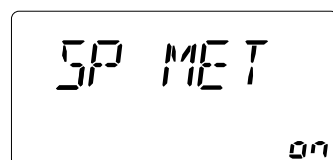

• CI-V baud rate

This item sets the data transfer rate. When “Auto” is selected, the baud rate is automatically set according to the connected controller or remote controller. The default is At (Auto).

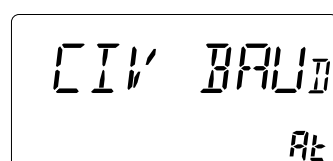

• CI-V address

To distinguish equipment, each CI-V transceiver has its own Icom standard address in hexadecimal code. The IC-718's address is 5E.

When 2 or more IC-718s are connected to an optional CT-17 CI-V LEVEL CONVERTER, rotate the main dial to select a different address for each IC-718 in the range 01H to 7FH. The default is 5E.

CIV ADD
5E

• CI-V Transceive

Transceive operation is possible with the IC-718 connected to other Icom HF transceivers or receivers. When "on" is selected, changing the frequency, operating mode, etc. on the IC-718 automatically changes those of connected transceivers (or receivers) and vice versa.

The default is on.

CIV TRN
on

• CI-V 731 mode

When connecting the IC-718 to the IC-735 for transceive operation, you must change the operating frequency data to 4 bytes.

- This item MUST be set to "on" when operating transceiver with the IC-735.

The default is oF (off).

CIV 731
oF

• OPTION Filter

When an optional IF filter is installed, this selection is necessary, otherwise the filters cannot be selected. Selections available are FL-96, FL-222, FL-52A, FL-53A, FL-257 and none (default). See p. 24 for usable filters for each mode and see P. 50 for filter installation.

FIL no

• Expand Filter

When an optional IF filter is installed, this selection expands filter and filter selection (W/N) key combination on operating mode independently.

The default is oF (off).

EXP FIL
on

• Filter select (Wide/Narrow)

When an optional IF filter is installed, you can arrange the filter and filter selection key combination. (p. 25)

^{CW}
WIDE THU

^{AM}
NARW NOR

■ Opening the transceiver's case

Follow the case and cover opening procedures shown here when you want to install an optional unit or adjust an internal unit, etc.

CAUTION: DISCONNECT the DC power cable from the IC-718 before performing any work on the transceiver. Otherwise, there is danger of electric shock and/or equipment damage.

- ① Remove the 5 screws from the top of the transceiver and 4 screws from the sides, then lift up the top cover.
- ② Remove the 5 screws from the bottom of the transceiver, then remove the bottom cover.

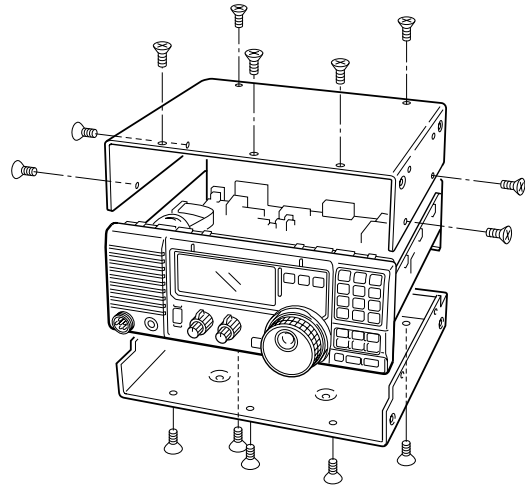

■ Optional bracket and carrying handle

◇ Mounting bracket

An optional IC-MB5 MOBILE MOUNTING BRACKET is available to install the radio under a table, on a wall, in a vehicle, etc.

Select an area to mount the receiver keeping in mind that the weight of the transceiver is approx. 3.80kg.

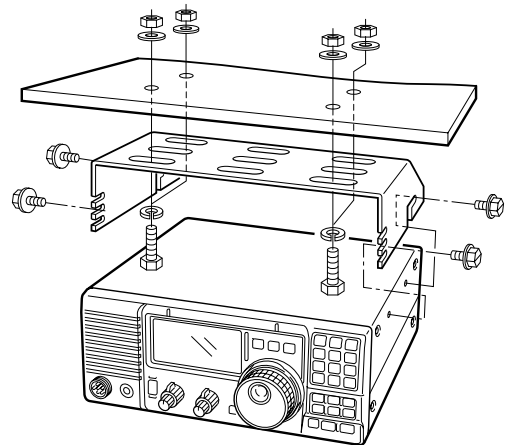

◇ Carrying handle

An optional handle allows you to easily carry and transport the transceiver.

Attach the MB-23 CARRYING HANDLE with the supplied rubber feet as shown.

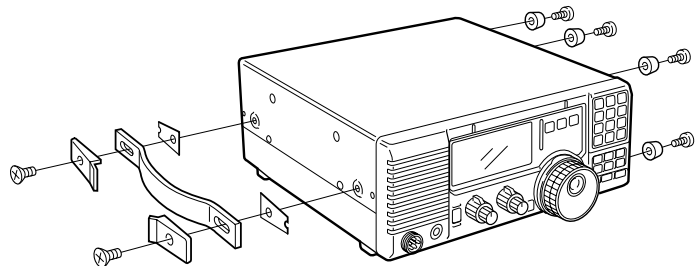

■ CR-338 HIGH STABILITY CRYSTAL UNIT

By installing the CR-338, the total frequency stability of the receiver will be improved.

- ① Remove the bottom cover as shown in the diagram before.
- ② Disconnect W2 from J4401 (MAIN unit) and W3 from J4201 (MAIN unit).
- ③ Remove 9 screws from the PLL unit, disconnect P4 from J201 (MAIN unit) and P2 from J401 (MAIN unit), then remove the PLL unit.

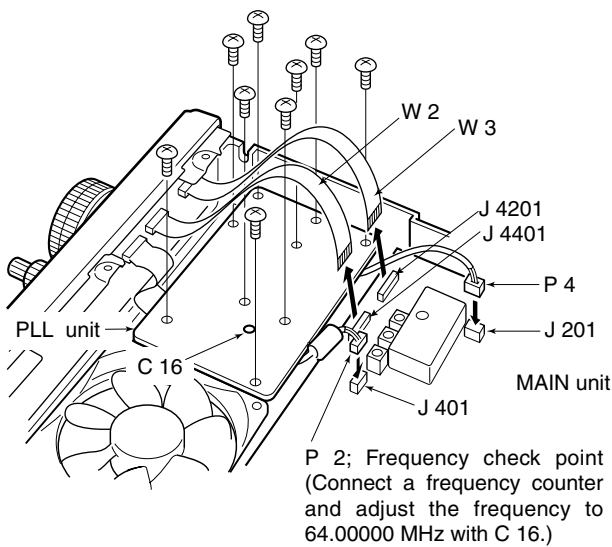

- ④ Remove the supplied internal crystal and replace with the CR-338.
- ⑤ Return the PLL unit, plugs and flat cables to their original positions.
- ⑥ Adjust the reference frequency at C16 using a frequency counter if desired.
 - Connect the frequency counter to P. 2 (PLL unit).
- ⑦ Return the bottom cover to its original position.

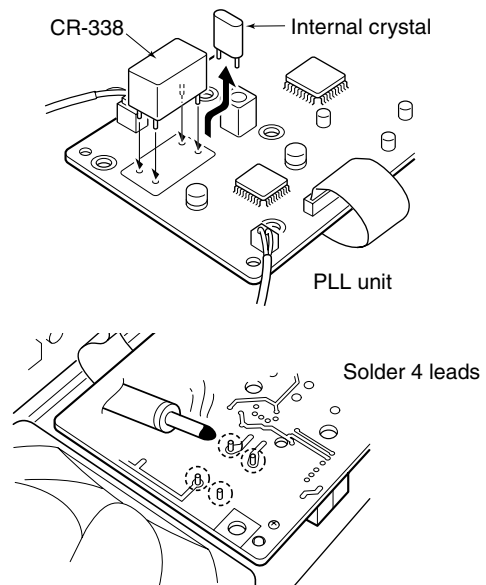

■ UT-102 VOICE SYNTHESIZER UNIT

The UT-102 announces the received frequency, mode, S-meter level and current time in a clear, electronically-generated voice, in English (or Japanese).

➔ Push [LOCK] for 1 sec. to announce the frequency, etc.

- ① Remove the bottom cover as shown above.
- ② Remove the protective paper attached to the bottom of the UT-102 to expose the adhesive strip.
- ③ Plug UT-102 into J2501 on the MAIN unit as shown at right.
- ④ Return the bottom cover to its original position.

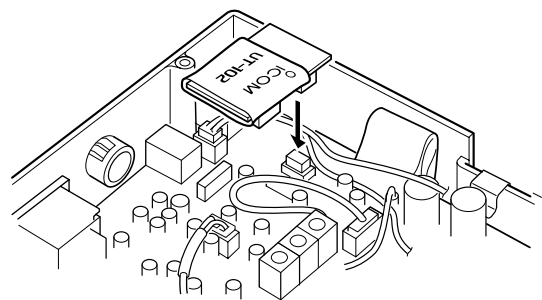

■ UT-106 DSP RECEIVE UNIT

The UT-106 provides AF DSP functions such as noise reduction and auto notch.

- ① Remove the bottom cover.
- ② Slide the insulating case onto the UT-106 as shown right. (Fig. 1)
- ③ Remove the connection cable (P2601) from J2602 on the MAIN unit. Connect the cable into J1 on the UT-106.
- ④ Plug the connection cable (P1) from the UT-106 to J2602 on the MAIN unit.
- ⑤ Plug the flat cable into J3 on the UT-106 and to J2603 on the MAIN unit.
 - Take care regarding the conductor direction.
- ⑥ Turn the UT-106 unit over. (Fig. 2)
 - No need to fix with an adhesive strip, etc.
- ⑦ Put the UT-106 on the MAIN unit.
 - No need to fix with an adhesive strip, etc.
 - Ensure that the surplus cable from UT-106 is stored under the unit.
- ⑧ Return the bottom cover to its original position.

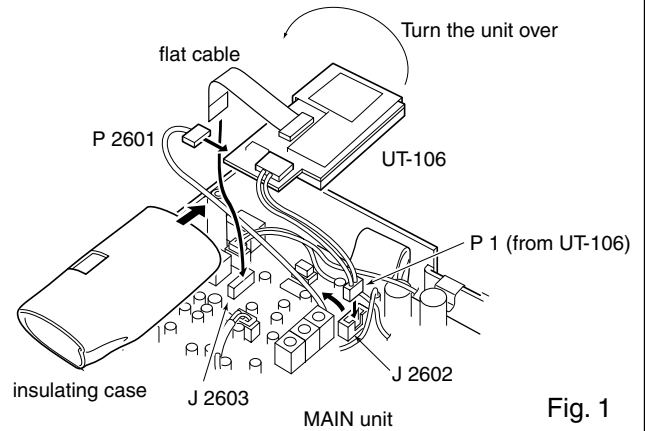

Fig. 1

- Turn the unit over

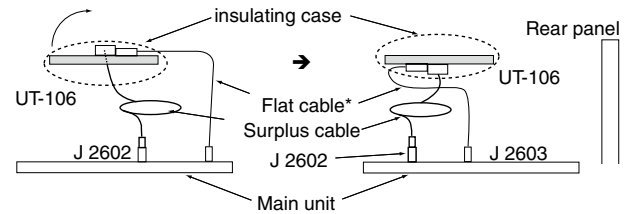

Fig. 2

* Supplied with UT-106

■ Optional IF filters

Several IF filters are available for the IC-718. You can install 1 filter for 455 kHz IF. Choose the appropriate filter for your operating needs. (pgs, 24–25)

◇ Installation

- ① Remove the bottom cover as shown on the p. 48.
- ② Remove 7 screws, connection cable p1 from J1, p5 from J701, W4 from J4101 and W5 from J4001 and 2 Tr-clampers as shown in the diagram below.
- ③ Install the desired 455 KHz filter as shown in the diagram below.
- ④ Mounting the filter with supplied washers and nuts.

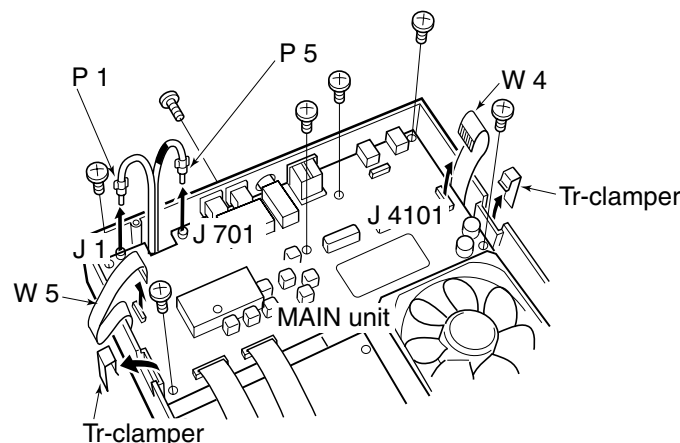

- ⑤ Solder the 4 leads.
- ⑥ Return the MAIN unit and bottom cover to their original positions.

After filter installation, specify the installed filter using initial set mode. (p. 47) Otherwise, the installed filter will not function properly.

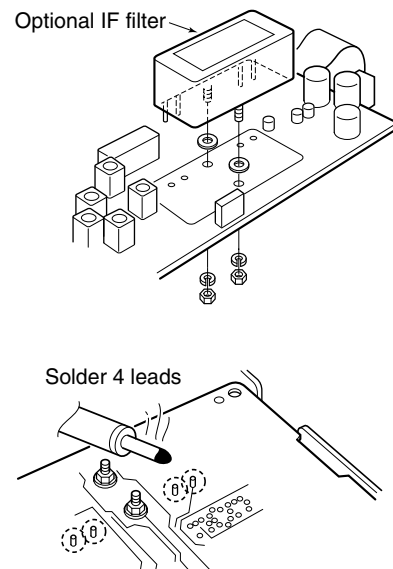

■ AT-180 internal switch description

The optional AT-180 has 3 operating conditions for HF band operation. Select a suitable condition according to your antenna system.

- ① Remove the top cover of the AT-180.
- ② Set the tuner switches to the desired positions according to the table below.

SW Position	Operation
S1	A (default) The tuner operating condition is set by S2 described below.
	THROUGH INHIBIT The tuner tunes the antenna even when the antenna has poor SWR (up to VSWR 3:1 after tuning). In this case, manual tuning is necessary each time you change the frequency although the tuner automatically starts tuning when the VSWR is higher than 3:1. This setting is called "through inhibit," however, the tuner is set to "through" if the VSWR is higher than 3:1 after tuning.
S2	C TUNER SENSITIVE CONDITION The tuner tunes each time you transmit (except SSB mode). Therefore, the lowest SWR is obtained at any given time. For SSB mode, the same condition is as the "D" position below.
	D (default) NORMAL CONDITION The tuner tunes when the SWR is higher than 1.5:1. Therefore, the tuner activates only when tuning is necessary.

• Specifications for the AT-180

- Frequency coverage : 1.9–54 MHz
- Input impedance : 50 Ω
- Maximum input power : 120 W
- Minimum tuning power : 8 W
- Matching impedance : 16.7–150 Ω (HF band)
20–125 Ω (50 MHz band)
- Tuning accuracy : Less than SWR 1.5:1
- Insertion loss : Less than 1.0 dB (after tuning)
- Power supply requirements : 13.8 V DC/1 A (supplied from the transceiver's ACC socket)
- Dimensions (mm/in) : 167(W)×58.6(H)×225(D)
6⁹/₁₆(W)×2⁵/₁₇(H)×8⁷/₈(D)
- Weight : 2.4 kg; 5 lb 4 oz
- Supplied accessories: coaxial cable (1 m), ACC cable (DIN 13 pins)

• AT-180 inside top cover

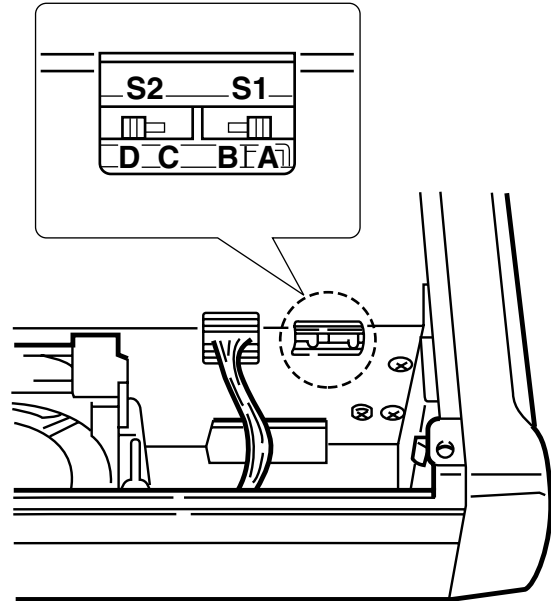

• Connector information for ACC(2) socket



PIN NO./ NAME	DESCRIPTION
① 8 V	Regulated 8 V output. (10 mA max.)
② GND	Connects to ground.
③ SEND	Input/output pin. Goes to ground when transmitting (20 mA max). When grounded, transmits.
④ BAND	Band voltage output. (Varies with amateur band; 0 to 8.0 V).
⑤ ALC	ALC output voltage (–4 to 0 V).
⑥ NC	No connection.
⑦ 13.8V	13.8 V output when power is ON (1 A max).

10 MAINTENANCE

■ Troubleshooting

The following chart is designed to help you correct problems which are equipment malfunctions.

If you are not able to locate the cause of a problem or solve it through the use of this chart, contact your nearest Icom Dealer or Service Center.

	PROBLEM	POSSIBLE CAUSE	SOLUTION	REF.
POWER	Power does not come on when the [POWER] switch is pushed.	<ul style="list-style-type: none"> • DC power cable is improperly connected. • Fuse is blown. • Power supply not turned ON. 	<ul style="list-style-type: none"> • Reconnect the DC power cable correctly. • Check for the cause, then replace the fuse with a spare one. (Fuses are installed in the DC power cable and the internal PA unit.) 	p. 12 p. 53
	No sounds comes from the speaker.	<ul style="list-style-type: none"> • Volume level is too low. • The squelch is closed. • The transceiver is in the transmitting condition. 	<ul style="list-style-type: none"> • Rotate [AF] clockwise to obtain a suitable listening level. • Rotate [RF/SQL] to 10 o'clock position to open the squelch. • Check the SEND line of an external unit, if desired. 	p. 2 p. 2 p. 6
RECEIVE	Sensitivity is low.	<ul style="list-style-type: none"> • The antenna is not connected properly. • The antenna for another band is connected. • The antenna is not properly tuned. • The attenuator is activated. 	<ul style="list-style-type: none"> • Reconnect to the antenna connector. • Connect an antenna suitable for the operating frequency. • Push [TUNER] for 2 sec. to manually tune the antenna. • Push [ATT] to select "ATT" OFF. 	— — p. 3 p. 3
	Receive audio is distorted.	<ul style="list-style-type: none"> • The operating mode is not selected correctly. • IF SHIFT function is activated. • Noise blanker function is activated. • Preamp is activated. • The noise reduction is activated and the [NR] control is set too high. 	<ul style="list-style-type: none"> • Select a suitable operating mode. • Rotate the SHIFT control to center position. • Push [NB] to turn the function OFF. • Push [P.AMP] to turn the function OFF. • Set the [NR] control for maximum readability. 	p. 20 p. 21 p. 21 p. 22 p. 23
	Transmitting is impossible.	<ul style="list-style-type: none"> • The operating frequency is not set to a ham band. 	<ul style="list-style-type: none"> • Set the frequency to a ham band. 	p. 17
TRANSMIT	Output power is too low.	<ul style="list-style-type: none"> • [RF POWER] is set too low. • [MIC GAIN] is set too low. • The antenna for another band is selected. • The antenna is not properly tuned. 	<ul style="list-style-type: none"> • Set [RF POWER] to a suitable position. • Set [MIC GAIN] to a suitable position. • Select an antenna suitable for the operating frequency. • Push [TUNE] for 2 sec. to manually tune the antenna. 	p. 42 p. 42 p. 10 p. 3
	No contact possible with another station.	<ul style="list-style-type: none"> • RIT function is activated. • Split frequency function is activated. 	<ul style="list-style-type: none"> • Push [RIT] to turn the function OFF. • Push [SPLIT] to turn the function OFF. 	p. 21 pgs. 7, 31, 32
	Transmitted signals are distorted.	<ul style="list-style-type: none"> • [MIC GAIN] too high. • [COMP] function is activated. 	<ul style="list-style-type: none"> • Set [MIC GAIN] to a suitable position. • Turn [COMP] OFF. 	p. 2 p. 27
	Programmed scan does not stop.	<ul style="list-style-type: none"> • Squelch is open. • [RF/SQL] is assigned to RF gain control and squelch is open. 	<ul style="list-style-type: none"> • Set [RF/SQL] to the threshold point. • Reset [RF/SQL] control assigned and set it to the threshold point. 	p. 3 p. 30
SCAN	Programmed scan does not start.	<ul style="list-style-type: none"> • The same frequencies have been programmed in scan edge memory channels P1 and P2. 	<ul style="list-style-type: none"> • Program different frequencies in scan edge memory channels P1 and P2. 	p. 40
	Memory scan does not start.	<ul style="list-style-type: none"> • 2 or more memory channels have not been programmed. 	<ul style="list-style-type: none"> • Program 2 or more memory channels. 	p. 40
DISPLAY	The displayed frequency does not change properly.	<ul style="list-style-type: none"> • The dial lock function is activated. • A quick set mode screen is selected. • The internal CPU has malfunctioned. 	<ul style="list-style-type: none"> • Push [LOCK] to deactivate the function. • Push [SET] to exit the quick set mode. • Reset the CPU. 	p. 6 p. 41 p. 53

■ Fuse replacement

If a fuse blows or the transceiver stops functioning, try to find the source of the problem, and replace the damaged fuse with a new, rated fuse.

CAUTION:-DISCONNECT the DC power cable from the transceiver when changing a fuse.

The IC-718 has 2 types of fuses installed for transceiver protection.

- DC power cable fuses FGB 20 A
- Circuitry fuse FGB 4 A

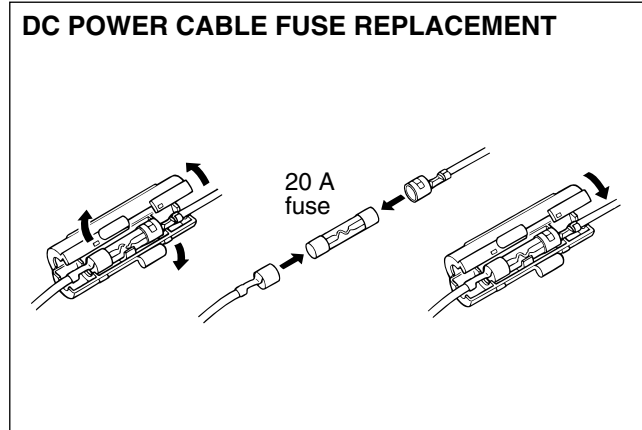

CIRCUITRY FUSE REPLACEMENT

The 13.8 V DC from the DC power cable is applied to all units in the IC-718 through the circuitry fuse. This fuse is installed in the MAIN unit.

- ① Remove the top cover as shown on p. 48
- ② Replace the circuitry fuse as shown in the diagram at right.
- ③ Replace the top cover.

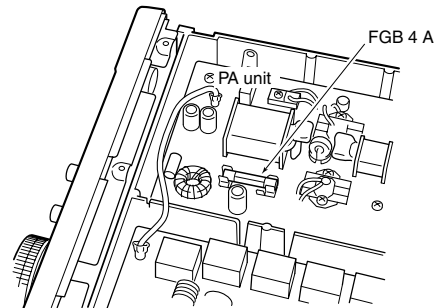

■ Resetting the CPU

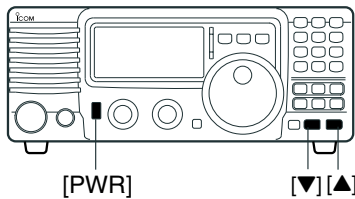

Resetting **CLEARs** all programmed contents in memory channels and returns programmed values in set mode to their defaults.

When first applying power or when the function seems to be displaying erroneous information, reset the CPU as follows:

- ① Make sure transceiver power is OFF.
- ② While pushing [UP ▲] and [▼ DN], push [PWR] to turn power ON.
 - The internal CPU is reset.
 - The transceiver displays its initial VFO frequencies when resetting is complete.

11 SPECIFICATIONS

◇ General

- Frequency coverage : Receive
0.03–29.999999 MHz*¹
Transmit
1.800– 1.999999 MHz*²
3.500– 3.999999 MHz*²
7.000– 7.300000 MHz
10.100–10.150000 MHz
14.000–14.350000 MHz
18.068–18.168000 MHz
21.000–21.450000 MHz
24.890–24.990000 MHz
28.000–29.700000 MHz

*¹Guaranteed range: 0.5–29.999999 MHz

*²Varies according to version

- Mode : USB, LSB, CW, RTTY, AM,
- Number of memory channels : 101 (99 regular, 2 scan edges)
- Frequency stability : Less than ± 200 Hz from 1 min. to 60 min. after power on. After that rate of stability less than ± 30 Hz/hr. at +25°C (+77°F). Temperature fluctuations 0°C to +50°C (+32°F to +122°F) less than ± 350 Hz.
- Power supply requirement : 13.8 V DC $\pm 15\%$ (negative ground)
- Current drain (at 13.8 V DC) : Receive
Standby 1.3 A
Max. audio 2.0 A
Transmit
Max. power 20.0A
- Operatable temp. range: –10°C to +60°C; +14°F to +140°F
- Antenna connector : SO-239 (50 Ω)
- Dimensions : 240(W) \times 95(H) \times 239(D) mm (projections not included) 9⁷/₁₆(W) \times 3³/₄(H) \times 9¹³/₃₂(D) in
- Weight (approx.) : 3.8 kg; 8 lb 6 oz
- ACC connector : 13-pin
- REMOTE connector : 2-conductor 3.5 (d) mm (1/8")

◇ Transmitter

- Output power :
SSB, CW, RTTY 2–100 W
AM 2–40 W
- Modulation system :
SSB Balanced modulation
AM Low level modulation

- Spurious emissions : Less than –50 dB below peak output power
*Spurious freq.; Below 30 MHz: –50 dB
Above 50 MHz: –60 dB
NOTE: Limit in dB decreases linearly with the logarithm of frequency in the range 30 MHz to 50 MHz.
- Carrier suppression : More than 40 dB
- Unwanted sideband : More than 50 dB
- Microphone connector: 8-pin connector (600 Ω)
- Key connector : 3-conductor 6.5 (d) mm (1/4")
- SEND/ALC connector : Phono (RCA)

◇ Receiver

- Receive system : Double-conversion superheterodyne system
- Sensitivity :
SSB, CW, RTTY 0.16 μ V (1.8–29.999999 MHz)
AM 13 μ V (0.5–1.799999 MHz)
2 μ V (1.8–29.999999 MHz)
- Squelch sensitivity (threshold):
SSB, CW, RTTY Less than 5.6 μ V
- Selectivity :
SSB, CW, RTTY More than 2.1 kHz/–6 dB
Less than 4.5 kHz/–60 dB
AM More than 6 kHz/–6 dB
Less than 20 kHz/–40 dB
- Spurious and image rejection ratio:
More than 70 dB
(1.8–29.999999 MHz)
- RIT variable range : ± 1200 Hz
- Audio output power : More than 2.0 W at 10% distortion with an 8 Ω load
- PHONES connector : 3-conductor 6.35 (d) mm (1/4")
- External SP connector: 2-conductor 3.5 (d) mm (1/8") / 8 Ω

All stated specifications are typical and subject to change without notice or obligation.

IC-PW1 HF + 50 MHz 1 KW LINER AMPLIFIER



Full-duty 1 kW linear amplifier including an automatic antenna tuner. Has automatic tuning and band selection capability. Full break-in (QSK) operation is possible. The amplifier/power supply unit and the remote control unit are separated.

AT-180 HF + 50 MHz AUTOMATIC ANTENNA TUNER



Fully automatic antenna tuner with preset memories for each 100 kHz. Unique "Automatic tuner on" function is available. See p. 51 for AT-180 specifications.

AH-4 HF + 50 MHz AUTOMATIC ANTENNA TUNER



Specially designed to tune a long wire antenna for portable or mobile HF operation. The PTT tuner start function provides simple operation.

- Input power rating: 120 W

AH-2b ANTENNA ELEMENT



A 2.5 m long antenna element for mobile operation with the AH-4.

- Frequency coverage: 3.5–28 MHz bands with the AH-4

PS-85 DC POWER SUPPLY



Light weight switching regulator system power supply.

- Output voltage: 13.8 V DC
- Max. current drain: 20 A

SM-8 DESKTOP MICROPHONE



Including 2 connection cables for simultaneous connection of 2 transceivers. Has [UP]/[DOWN] switches. .

SM-20 DESKTOP MICROPHONE



Unidirectional, electret microphone for base station operation. Includes [UP]/[DOWN] switches and a low cut function.

SM-6 DESKTOP MICROPHONE



Electret condenser-type desktop microphone.

HM-36 HAND MICROPHONE



Hand microphone equipped with [UP]/[DOWN] switches. Same as supplied.

SP-20 EXTERNAL SPEAKER



4 audio filters; headphone jack; can connect to 2 transceivers.

- Input impedance: 8 Ω
- Max. input power: 5 W

SP-21 EXTERNAL SPEAKER



Designed for base station operation.

Input impedance: 8 Ω
Max. input power: 5 W

SP-7 EXTERNAL SPEAKER



Compact speaker for base station operation. Height can be adjusted for your convenience.

FL-52A, FL-53A, FL-96, FL-222 and FL-257 455 KHz FILTERS



- FL-52A: 500 Hz/−6dB (CW/RTTY narrow)
- FL-53A: 250 Hz/−6dB (CW narrow)
- FL-96: 2.8 KHz/−6dB (SSB wide)
- FL-222: 1.8 KHz/−6dB (SSB narrow)
- FL-257: 3.3 KHz/−6dB (SSB wide)

UT-106 DSP RECEIVE UNIT



Provides AF DSP functions such as noise reduction and auto notch.

UT-102 VOICE SYNTHESIZER



Announces the receive frequency, mode, S-meter level and current time in a clear, electronically-generated voice, in English (or Japanese).

CR-338 HIGH-STABILITY CRYSTAL UNIT



Contains a temperature-compensating oven heater and crystal unit for improved frequency stability.

- Frequency stability: ± 0.5 ppm

MB-23 CARRYING HANDLE



Carrying handle, convenient for portable operation.

IC-MB5 MOBILE MOUNTING BRACKET



Transceiver mounting bracket for mobile operation.

CT-17 CI-V LEVEL CONVERTER



For remote receiver control using a personal computer. You can change frequencies, operating mode, memory channels, etc.

AH-710 FOLDED DIPOLE ANTENNA

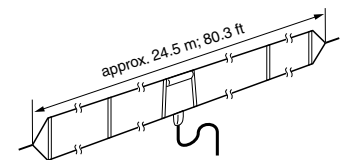

Covers from 1.9–30 MHz bands. Has an SO-239 connector. 30 m (98.4 ft) coaxial cable with PL-259 connector is supplied.

OPC-599 ADAPTER CABLE

13-pin, ACC connector to 7-pin + 8-pin ACC connector.

■ Remote jack (CI-V) information

• CI-V connection example

The transceiver can be connected through an optional CT-17 CI-V LEVEL CONVERTER to a personal computer equipped with an RS-232C port. The Icom Communications Interface-V (CI-V) controls the following functions of the transceiver.

Up to 4 Icom CI-V transceivers or receivers can be connected to a personal computer equipped with an RS-232C port. See p. 32 for setting the CI-V condition using set mode.

• Data format

The CI-V system can be operated using the following data formats. Data formats differ according to command numbers. A data area or sub command is added for some commands.

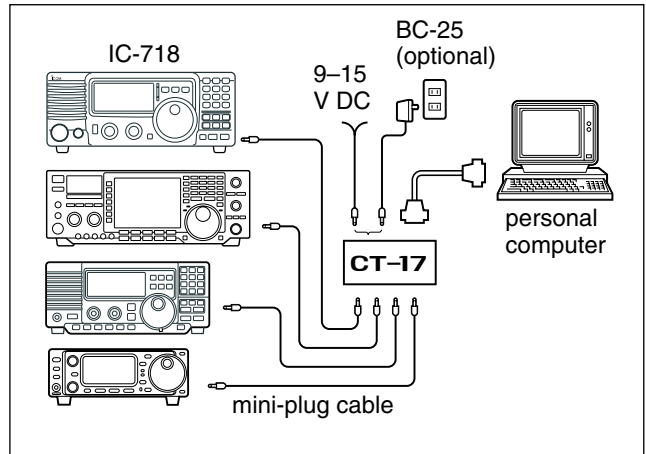

CONTROLLER TO IC-718

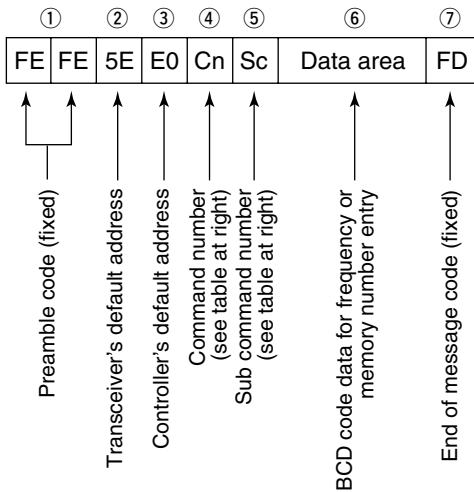

OK MESSAGE TO CONTROLLER

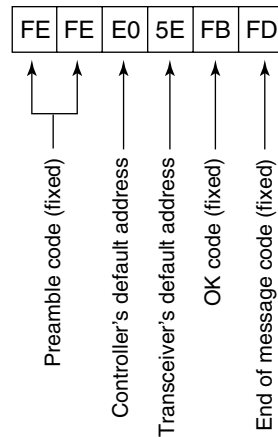

IC-718 TO CONTROLLER

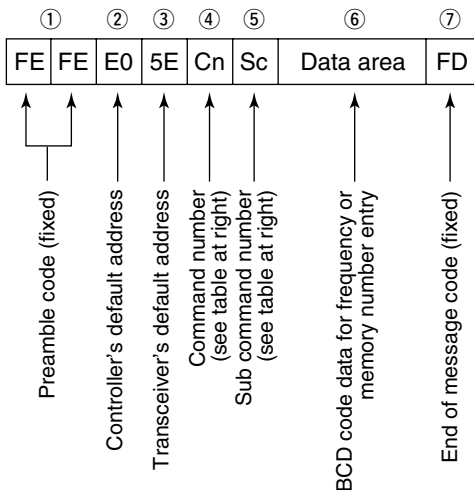

NG MESSAGE TO CONTROLLER

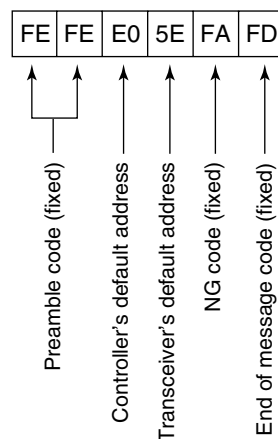

13 CONTROL COMMAND

• Command table

Command	Sub command	Description
00	—	Send frequency data
01	—	Send mode data
02	—	Read Upper/Lower frequencies
03	—	Read frequencies
04	—	Read operating mode
05	—	Set operating frequency
06	—	Set mode
07	—	Set VFO
	00	Set VFO A
	01	Set VFO B
	A0	VFO A=B
08	B0	VFO A ⇄ B
	—	Set Memory
09	—	Set Memory CH
	—	Memory write
0A	—	Memory ⇄ VFO
0B	—	Memory clear
0E	00	Scan stop
	01	Prog/Memo Scan Start
	D0	Resume OFF
	D3	Resume ON
0F	00	SPLIT OFF
	01	SPLIT ON
10	—	Set TS
11	—	ATT
14	01	AF Gain
	02	RF Gain
	03	SQL Level
	06	NR Level
	09	CW Pitch
	0A	RF Power
	0B	MIC Gain
	0C	KEY Speed
15	0F	BK-IN Delay
	01	Read SQL Open/Close
16	02	Read SIG (S-meter) level
	02	PRE-AMP
16	22	NB
	40	NR
	41	Auto Notch
	44	COMP
	46	VOX
	47	BK-IN
19	00	Read ID

■ Top view

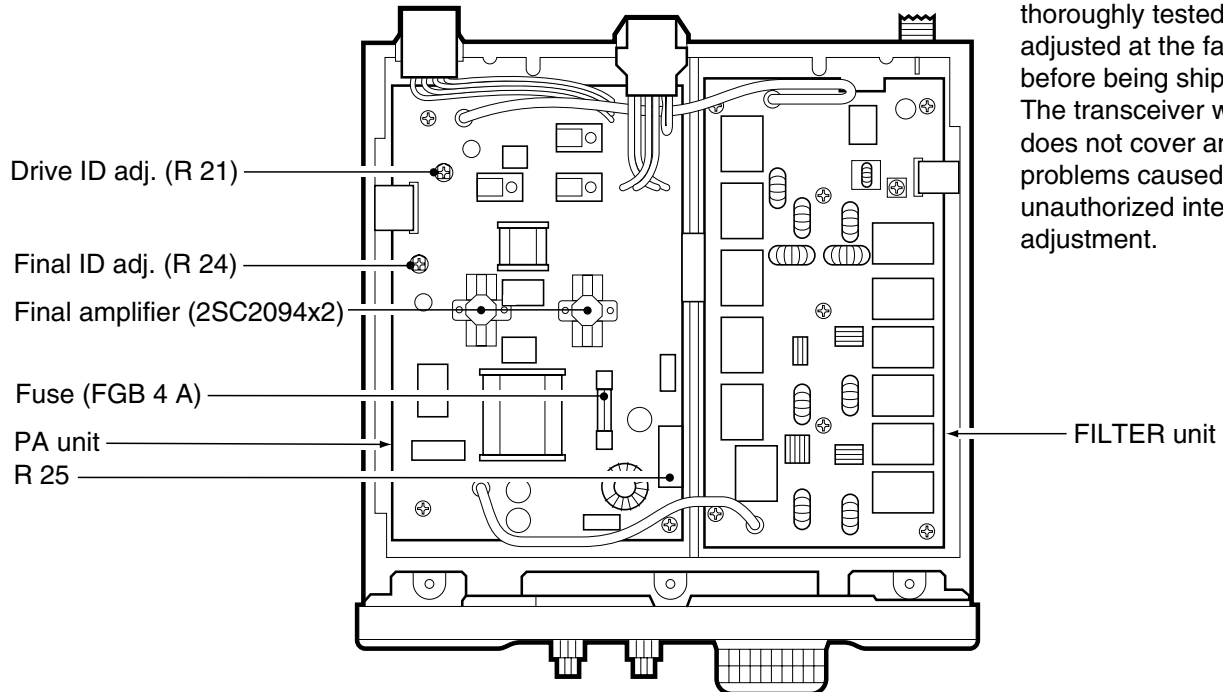

Caution:

The transceiver has been thoroughly tested and adjusted at the factory before being shipped. The transceiver warranty does not cover any problems caused by unauthorized internal adjustment.

■ Bottom view

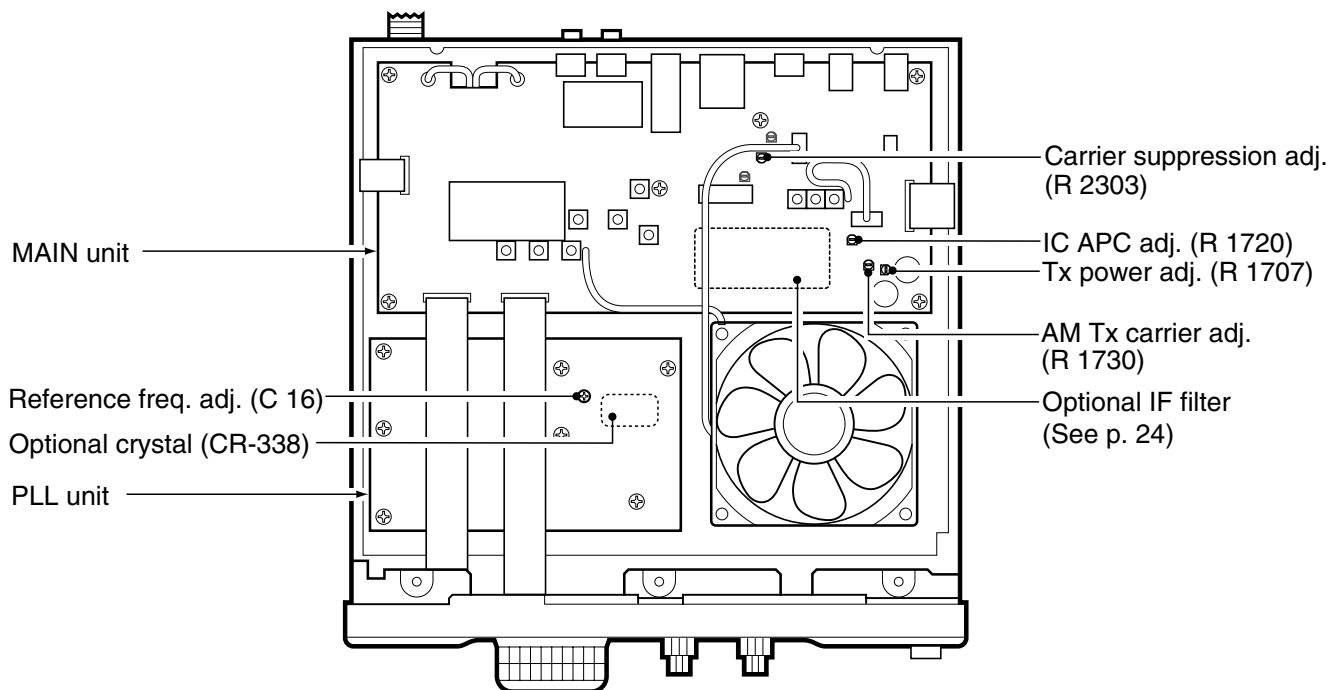

15 INSTALLATION NOTES

For amateur base station installations, it is recommended that the forwards clearance in front of the antenna array is calculated relative to the EIRP (Effective Isotropic Radiated Power). The clearance height below the antenna array can be determined in most cases from the RF power at the antenna input terminals.

As different exposure limits have been recommended for different frequencies, a relative table shows a guideline for installation considerations.

Below 10 MHz, the recommended limits are specified in terms of V/m or A/m fields as they are likely to fall within the near-field region. Similarly, at antennae may be physically short in terms of electrical length and that the installation will require some antenna matching device which can create high intensity magnetic fields. Analysis of such MF installations is best considered in association with published guidance notes such as the FCC OET Bulletin 65 Edition 97-01 and its annexes relative to amateur transmitter installations. Further information can be found at <http://www.arrl.org/>

• Typical amateur radio installation

Exposure distance assumes that the predominant radiation pattern is forwards and that radiation vertically downwards is at unity gain (sidelobe suppression is equal to main lobe gain). This is true of almost every gain antenna today. Exposed persons are assumed to be beneath the antenna array and have a typical height to 1.8 m.

The figures assume the worst case emission of constant carrier.

For the bands 10 MHz and higher the following power density limits are recommended :

10–30 MHz 2 W/sq m

Watts (EIRP)/ Clearance heights

1	2.1 (m)
10	2.8
25	3.4
100	5
1000	12

Watts (EIRP)/ Forward clearance

100	2 (m)
1,000	6.5
10,000	20
100,000	65

In all cases any possible risk depends on the transmitter being activated for long periods. (actual recommendation limits are specified as an average of 6 minutes) Normally the transmitter is not active for long periods of time. Some radio licenses will require that a timer circuit automatically cuts the transmitter after 1–2 minutes etc.

Similarly some types of transmitter, SSB, CW, AM, etc. have a lower 'average' output power and the perceived risk is even lower.

CE Versions of the IC-718 which display the “CE” symbol on the serial number seal, comply with the essential requirements of the European Radio and Telecommunication Terminal Directive 1999/5/EC.

! This warning symbol indicates that this equipment operates in non-harmonised frequency bands and/or may be subject to licensing conditions in the country of use. Be sure to check that you have the correct version of this radio or the correct programming of this radio, to comply with national licensing requirement.

List of Country codes (ISO 3166-1)

	Country	Codes		Country	Codes
1	Austria	AT	18	Liechtenstein	LI
2	Belgium	BE	19	Lithuania	LT
3	Bulgaria	BG	20	Luxembourg	LU
4	Croatia	HR	21	Malta	MT
5	Czech Republic	CZ	22	Netherlands	NL
6	Cyprus	CY	23	Norway	NO
7	Denmark	DK	24	Poland	PL
8	Estonia	EE	25	Portugal	PT
9	Finland	FI	26	Romania	RO
10	France	FR	27	Slovakia	SK
11	Germany	DE	28	Slovenia	SI
12	Greece	GR	29	Spain	ES
13	Hungary	HU	30	Sweden	SE
14	Iceland	IS	31	Switzerland	CH
15	Ireland	IE	32	Turkey	TR
16	Italy	IT	33	United Kingdom	GB
17	Latvia	LV			



DECLARATION OF CONFORMITY

We Icom Inc. Japan
1-1-32, Kamiminami, Hirano-ku
Osaka 547-0003, Japan



Declare on our sole responsibility that this equipment complies with the essential requirements of the Radio and Telecommunications Terminal Equipment Directive, 1999/5/EC, and that any applicable Essential Test Suite measurements have been performed.

Düsseldorf 17th July 2007
Place and date of issue

Kind of equipment: HF ALL BAND TRANSCEIVER

Icom (Europe) GmbH
Himmelgeisterstraße 100
D-40225 Düsseldorf
Authorized representative name

Type-designation: IC-718

Version (where applicable):

This compliance is based on conformity according to Annex III of the directive 1999/5/EC using the following harmonised standards:

H. Ikegami
General Manager

- i) EN 301 489-1 V1.4.1 (August 2000)
- ii) EN 301 489-15 V1.2.1 (August 2002)
- iii) EN 301 783-2 V1.1.1 (September 2000)
- iv) EN 60950-1: 2001

Signature

Icom Inc.

Version and Frequency coverage

EUR (#03)	
Tx	Rx
1.800000 – 1.999999	0.500000 – 29.999999
3.500000 – 3.800000	
7.000000 – 7.100000	
10.100000 – 10.150000	
14.000000 – 14.350000	
18.068000 – 18.168000	
21.000000 – 21.450000	
24.890000 – 24.990000	
28.000000 – 29.700000	

FRA (#05)			
Tx		Rx	
1.810000 – 1.850000		1.810000 – 1.850000	
3.500000 – 3.800000		3.500000 – 3.800000	
7.000000 – 7.100000		7.000000 – 7.100000	
10.100000 – 10.150000		10.100000 – 10.150000	
14.000000 – 14.350000		14.000000 – 14.350000	
18.068000 – 18.168000		18.068000 – 18.168000	
21.000000 – 21.450000		21.000000 – 21.450000	
24.890000 – 24.990000		24.890000 – 24.990000	
28.000000 – 29.700000		28.000000 – 29.700000	

ITA (#04)	
Tx	Rx
1.800000 – 1.999999	0.500000 – 29.999999
3.400000 – 3.999999	
6.900000 – 7.499999	
9.900000 – 10.499999	
13.900000 – 14.499999	
17.900000 – 18.499999	
20.900000 – 21.499999	
24.400000 – 25.099999	
28.000000 – 29.999999	

ESP (#06)			
Tx		Rx	
1.830000 – 1.850000		1.830000 – 1.850000	
3.500000 – 3.800000		3.500000 – 3.800000	
7.000000 – 7.100000		7.000000 – 7.100000	
10.100000 – 10.150000		10.100000 – 10.150000	
14.000000 – 14.350000		14.000000 – 14.350000	
18.068000 – 18.168000		18.068000 – 18.168000	
21.000000 – 21.450000		21.000000 – 21.450000	
24.890000 – 24.990000		24.890000 – 24.990000	
28.000000 – 29.700000		28.000000 – 29.700000	

(Unit: MHz)

Count on us!

IC-718 #03
(Europe)

< Intended Country of Use >

<input checked="" type="checkbox"/>	AT	<input type="checkbox"/>	BE	<input checked="" type="checkbox"/>	CY	<input checked="" type="checkbox"/>	CZ	<input checked="" type="checkbox"/>	DK	<input checked="" type="checkbox"/>	EE
<input checked="" type="checkbox"/>	FI	<input type="checkbox"/>	FR	<input checked="" type="checkbox"/>	DE	<input type="checkbox"/>	GR	<input checked="" type="checkbox"/>	HU	<input checked="" type="checkbox"/>	IE
<input type="checkbox"/>	IT	<input type="checkbox"/>	LV	<input checked="" type="checkbox"/>	LT	<input type="checkbox"/>	LU	<input checked="" type="checkbox"/>	MT	<input checked="" type="checkbox"/>	NL
<input checked="" type="checkbox"/>	PL	<input type="checkbox"/>	PT	<input checked="" type="checkbox"/>	SK	<input checked="" type="checkbox"/>	SI	<input type="checkbox"/>	ES	<input checked="" type="checkbox"/>	SE
<input checked="" type="checkbox"/>	GB	<input type="checkbox"/>	IS	<input checked="" type="checkbox"/>	LI	<input type="checkbox"/>	NO	<input type="checkbox"/>	CH	<input checked="" type="checkbox"/>	BG
<input checked="" type="checkbox"/>	RO	<input type="checkbox"/>	TR	<input type="checkbox"/>	HR						

IC-718 #04
(Italy)

< Intended Country of Use >

<input type="checkbox"/>	AT	<input type="checkbox"/>	BE	<input type="checkbox"/>	CY	<input type="checkbox"/>	CZ	<input type="checkbox"/>	DK	<input type="checkbox"/>	EE
<input type="checkbox"/>	FI	<input type="checkbox"/>	FR	<input type="checkbox"/>	DE	<input type="checkbox"/>	GR	<input type="checkbox"/>	HU	<input type="checkbox"/>	IE
<input checked="" type="checkbox"/>	IT	<input type="checkbox"/>	LV	<input type="checkbox"/>	LT	<input type="checkbox"/>	LU	<input type="checkbox"/>	MT	<input type="checkbox"/>	NL
<input type="checkbox"/>	PL	<input type="checkbox"/>	PT	<input type="checkbox"/>	SK	<input type="checkbox"/>	SI	<input type="checkbox"/>	ES	<input type="checkbox"/>	SE
<input type="checkbox"/>	GB	<input type="checkbox"/>	IS	<input type="checkbox"/>	LI	<input type="checkbox"/>	NO	<input type="checkbox"/>	CH	<input type="checkbox"/>	BG
<input type="checkbox"/>	RO	<input type="checkbox"/>	TR	<input type="checkbox"/>	HR						

IC-718 #05
(France)

< Intended Country of Use >

<input type="checkbox"/>	AT	<input type="checkbox"/>	BE	<input type="checkbox"/>	CY	<input type="checkbox"/>	CZ	<input type="checkbox"/>	DK	<input type="checkbox"/>	EE
<input type="checkbox"/>	FI	<input checked="" type="checkbox"/>	FR	<input type="checkbox"/>	DE	<input type="checkbox"/>	GR	<input type="checkbox"/>	HU	<input type="checkbox"/>	IE
<input type="checkbox"/>	IT	<input type="checkbox"/>	LV	<input type="checkbox"/>	LT	<input type="checkbox"/>	LU	<input type="checkbox"/>	MT	<input type="checkbox"/>	NL
<input type="checkbox"/>	PL	<input type="checkbox"/>	PT	<input type="checkbox"/>	SK	<input type="checkbox"/>	SI	<input type="checkbox"/>	ES	<input type="checkbox"/>	SE
<input type="checkbox"/>	GB	<input type="checkbox"/>	IS	<input type="checkbox"/>	LI	<input type="checkbox"/>	NO	<input type="checkbox"/>	CH	<input type="checkbox"/>	BG
<input type="checkbox"/>	RO	<input type="checkbox"/>	TR	<input type="checkbox"/>	HR						

IC-718 #06
(Spain)

< Intended Country of Use >

<input type="checkbox"/>	AT	<input type="checkbox"/>	BE	<input type="checkbox"/>	CY	<input type="checkbox"/>	CZ	<input type="checkbox"/>	DK	<input type="checkbox"/>	EE
<input type="checkbox"/>	FI	<input type="checkbox"/>	FR	<input type="checkbox"/>	DE	<input type="checkbox"/>	GR	<input type="checkbox"/>	HU	<input type="checkbox"/>	IE
<input type="checkbox"/>	IT	<input type="checkbox"/>	LV	<input type="checkbox"/>	LT	<input type="checkbox"/>	LU	<input type="checkbox"/>	MT	<input type="checkbox"/>	NL
<input type="checkbox"/>	PL	<input type="checkbox"/>	PT	<input type="checkbox"/>	SK	<input type="checkbox"/>	SI	<input checked="" type="checkbox"/>	ES	<input type="checkbox"/>	SE
<input type="checkbox"/>	GB	<input type="checkbox"/>	IS	<input type="checkbox"/>	LI	<input type="checkbox"/>	NO	<input type="checkbox"/>	CH	<input type="checkbox"/>	BG
<input type="checkbox"/>	RO	<input type="checkbox"/>	TR	<input type="checkbox"/>	HR						

Free Manuals Download Website

<http://myh66.com>

<http://usermanuals.us>

<http://www.somanuals.com>

<http://www.4manuals.cc>

<http://www.manual-lib.com>

<http://www.404manual.com>

<http://www.luxmanual.com>

<http://aubethermostatmanual.com>

Golf course search by state

<http://golfingnear.com>

Email search by domain

<http://emailbydomain.com>

Auto manuals search

<http://auto.somanuals.com>

TV manuals search

<http://tv.somanuals.com>