

ICOM[®]

INSTRUCTION MANUAL

PMR446 FM TRANSCEIVER

IC-F22SR



Icom Inc.

Download from www.Somanuals.com. All Manuals Search And Download.

FOREWORD

Thank you for purchasing the IC-F22SR PMR446 FM transceiver. This PMR FM transceiver meets the European PMR446 specification. This transceiver is designed for those who require top-grade quality, performance and outstanding reliability under the most demanding conditions.

FEATURES

- *Free of user-license and applications*
- *All 8 PMR channels and Auto Scan channel are available*
- *52 convenient CTCSS tone channels*
- *83 convenient DTCS tone channels also available*
- *Rugged construction*
- *500 mW (ERP) High output power*

Icom, Icom Inc. and the ICOM logo are registered trademarks of Icom Incorporated (Japan) in the United States, the United Kingdom, Germany, France, Spain, Russia and/or other countries.

■ 2 types of built-in Code Squelch Systems:

CTCSS; Continuous Tone Coded Squelch System

DTCS; Digital Tone Code Squelch

CTCSS* and DTCS* encoder/decoder are standard, providing quiet stand-by. Audio (voice) signals are output only when a signal with a matched CTCSS or DTCS tone signal is received—very helpful for group communications. (pgs. 14, 28)

*Select one of CTCSS or DTCS for your convenience.

■ 2 types of “Ring” function

The “Smart-Ring”* function and the “Call-Ring” function are available for smart and simple station calls providing a telephone-style ring when called. 16 different ringing tones are available.

(pgs. 19–20)

*“Smart-Ring” function available only when all of your group station use the same CTCSS tone code on the same operating channel.

SUPPLIED ACCESSORIES

- Belt clip 1
- BC-146* (Regular charger). 1 set
(*Depends on version)

◇ Attach or detach the belt clip to the transceiver as illustrated below.

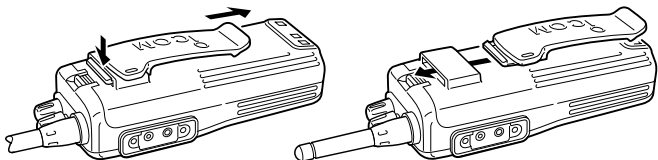

IMPORTANT

READ ALL INSTRUCTIONS carefully and completely before using the transceiver.

SAVE THIS INSTRUCTION MANUAL—This instruction manual contains important operating instructions for the IC-F22SR PMR446 FM transceiver.

CAUTIONS

⚠ **WARNING! NEVER** hold the transceiver so that the antenna is very close to, or touching exposed parts of the body, especially the face or eyes, while transmitting. The transceiver will perform best if the microphone is 5 to 10 cm away from the lips and the transceiver is vertical.

⚠ **WARNING! NEVER** operate the transceiver with a headset or other audio accessories at high volume levels.

DO NOT push the PTT when not actually desiring to transmit.

DO NOT modify the transceiver for any reason.

AVOID using or placing the transceiver in direct sunlight or in areas with temperatures below -25°C or above $+55^{\circ}\text{C}$. In an extreme low temperature environment (around -25°C), the capacity of Alkaline or dry cell batteries may exhaust quickly. In such case, we recommend to replace the batteries, when the “Low Battery” warning appears during transmission.

The use of non-Icom battery packs/chargers may impair transceiver performance and invalidate the warranty.

TABLE OF CONTENTS

FOREWORD	i
FEATURES	i-ii
SUPPLIED ACCESSORIES	ii
IMPORTANT	iii
CAUTIONS	iii
TABLE OF CONTENTS	iv
1 PANEL DESCRIPTION	1-3
■ Switches, controls, keys and connectors	1-2
■ LED indicator	3
2 BATTERY PACKS	4-10
■ Battery pack replacement	4
■ Battery cautions	5
■ Battery charging	6
■ Charging NOTE	9
■ Battery case (Option)	10
3 BASIC OPERATION	11-18
■ Receiving and transmitting	11
■ Setting squelch level	13
■ Auto scan function	13
■ Setting the group code number	14-18
4 RING FUNCTION	19-20
■ Smart-Ring	19
■ Call-Ring	19
5 OTHER FUNCTIONS	21-23
■ Monitor audible function	21
■ Time-Out Timer	21
■ Power save function	22
■ Low battery indication	22
■ Optional HM-75A functions	23
6 SPECIFICATIONS	24
7 OPTIONS	25-26
8 GLOSSARY	27-28
9 CE	29-30
■ DECLARATION OF CONFORMITY	30

1 PANEL DESCRIPTION

■ Switches, controls, keys and connectors

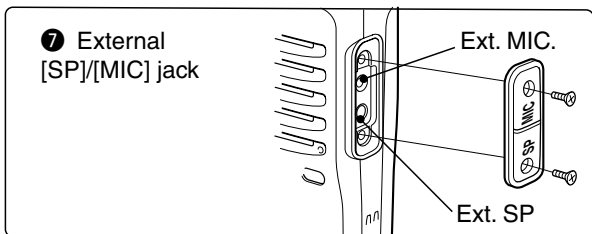
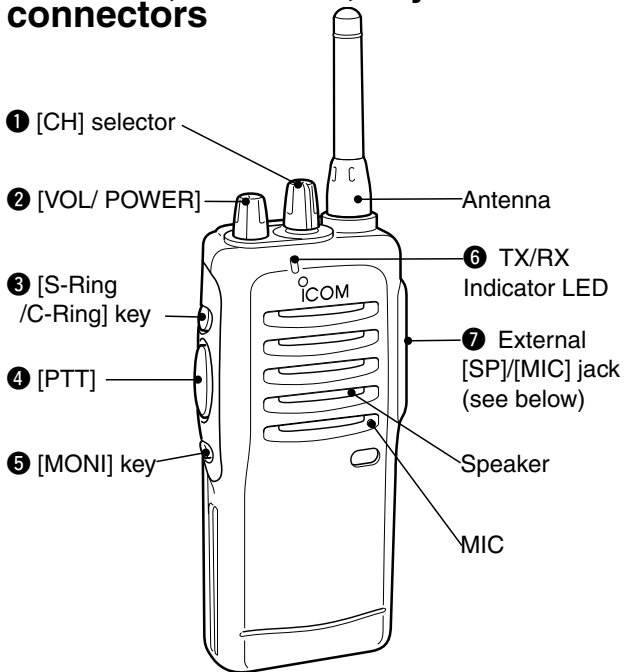

1 CHANNEL SELECTOR [CH]

- Rotate the selector to select the desired channel number 1 to 15. (pgs. 11, 12)
- Select the Auto Scan channel No.16. (p. 13)
- Select the Call-Ring melody. (p. 19)

2 VOLUME/POWER CONTROL [VOL/POWER]

- Rotate the [VOL/POWER] clockwise to turn the power ON/OFF. A long power ON beep emits when turning the power ON.
- Rotate clockwise to increase and counterclockwise to decrease the audio volume.

3 SMART-RING/CALL-RING KEY [S-Ring/C-Ring]

- Push to send a Smart-Ring call. (p. 19)
- Push and hold to send a Call-Ring. (p. 19)

4 PTT SWITCH [PTT]

- Push and hold to transmit; release to receive.

5 MONITOR KEY [MONI]

- Push and hold to open the noise/tone squelch.
- Push to turn the tone squelch ON.

6 TX/RX INDICATOR LED [LED]

- Lights red while transmitting.
- Lights green while receiving a signal, or squelch is open.
- Lights orange while sending/receiving a Smart-Ring call. (p. 19)
- Indicates the Low-battery condition. (p. 3)

7 EXTERNAL SPEAKER AND MICROPHONE JACKS [SP]/[MIC]

- Connects an optional speaker-microphone such as HM-75A. (p. 23)

1 PANEL DESCRIPTION

■ LED indicator

The TX/RX indicator LED indicates information in several ways as follows;
(Ref.; R=Red, G=Green, O=Orange)

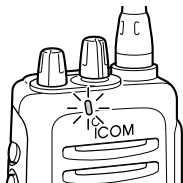

[Brink patterns]

- TX: Turns Red while transmitting a signal.

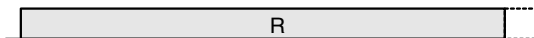

- RX (Busy): Turns Green while receiving a signal.

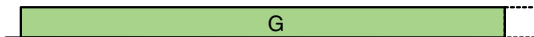

- Smart-Ring: Calling or answering back the Smart-Ring now.



- Fast/Slow scan: CH scanning or CTCSS FIND is functioning now.



- Low BATT1: You should charge the battery. (blinks slowly)

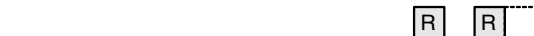

- Low BATT2: You must charge the battery. (blinks fast)

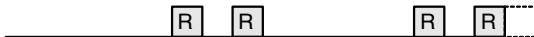

- TX low BATT1: Low BATT1 was detected during TX mode.



- TX low BATT2: Low BATT2 was detected during TX mode.



CAUTION:

- Low BATT3: If you did not charge the battery after Low BATT2 warning has appeared, the Low BATT3 warning beep emits for 15 sec. then the power turns OFF automatically.

BATTERY PACKS 2

■ Battery pack replacement

Before replacing the battery pack, the volume control **MUST** be rotated fully counterclockwise, until a click is heard, to **turn the power OFF**.

- Push the battery release forward, then pull the battery pack upward with the transceiver facing you.

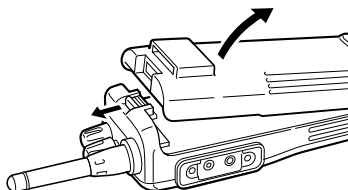

◇ BATTERY PACKS

Battery pack	Voltage	Capacity	Charging period		Operating period*
			BC-146	BC-144, BC-119 or BC-121	
BP-208	Battery case for AA (R6) × 6 alkaline				
BP-209	7.2 V	1100 mAh	12 hrs	1.5 hrs	14.5 hrs
BP-210	7.2 V	1650 mAh	18.5 hrs	2 hrs	21.5 hrs
BP-222	7.2 V	600 mAh	6.5 hrs	1 hr	8 hrs

* Operating periods are calculated under the following conditions;

Tx : Rx : standby = 5 : 5 : 90

Operating period depends on the alkaline cells used. (BP-208 only)

■ Battery cautions

- **CAUTION! NEVER** short the terminals of the battery pack (or charging terminals of the transceiver). Also, current may flow into nearby metal objects such as a necklace, so be careful when placing battery packs (or the transceiver) in handbags, etc. Simply carrying with or placing near metal objects such as a necklace, etc. causes shorting. This will damage not only the battery pack, but also the transceiver.
- **NEVER** incinerate used battery packs. Internal battery gas may cause an explosion.
- **NEVER** immerse the battery pack in water. If the battery pack becomes wet, be sure to wipe it dry **BEFORE** attaching it to the transceiver.
- **Clean** the battery terminals to avoid rust or miss contact.
- **Keep** battery contacts clean. It's a good idea to clean battery terminals once a week.

If your battery pack seems to have no capacity even after being charged, completely discharge it, then fully charge the battery pack again. If the battery pack still does not retain a charge (or only very little charge), a new battery pack must be purchased.

■ Battery charging

◇ Regular charging with the BC-146

The supplied* BC-146 provides regular charging of optional battery pack with/ without transceiver.

(*depends on version)

◇ Spacer combination.

Especially when charging the battery with the transceiver;

- Be sure to attach the spacer (Spacer B/C) to the adaptor (Spacer A) with the orientation as follows.
- Attach the spacer (Spacer B/C) to the adaptor with the orientation of the stamp “ⓐ” pointing up.

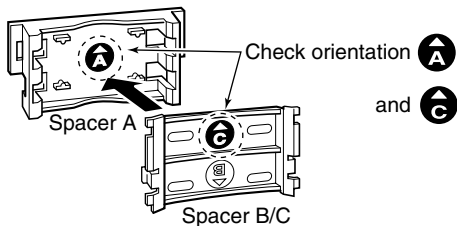

NOTE: Push the notch carefully when removing the spacer from the adaptor.

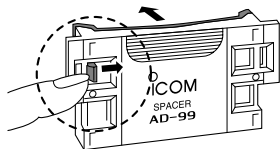

2 BATTERY PACKS

◇ Regular charging with the BC-146 (continued)

- First insert the spacer in to the BC-146, then insert the battery or the transceiver.
- Be sure to check orientation and the spacer combination.

Avoid overcharging—Batteries must be removed from the charger to stop charging. Batteries should not be charged for more than 24 hours.

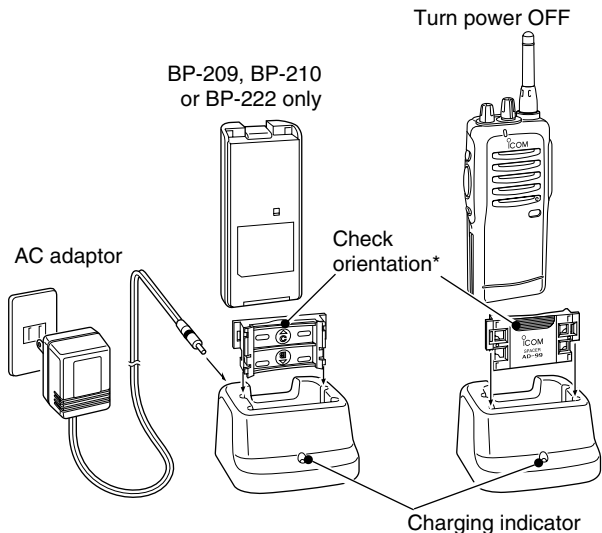

*Viewable stamps of the spacer may differ according to the spacer combination. See p. 6 for details.

◇ Rapid charging with the BC-121+AD-94 (#11)

The optional BC-121 allows up to 6 battery packs to be charged simultaneously. The following are additionally required.

- Six AD-94 (#11) (Some versions require additional AD-99s).
- An AC adaptor (may be supplied with the BC-121 depending on version).

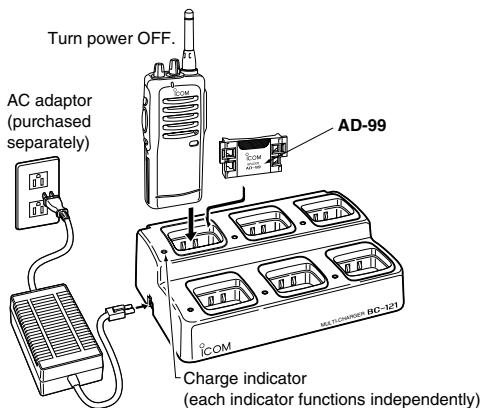

◇ Rapid charging with the BC-144+AD-99

The optional BC-144 provides rapid charging of optional battery packs.

The following are additionally required:

- One AD-99 (depends on version).
- An AC adaptor (may be supplied with the BC-144 depending on version).

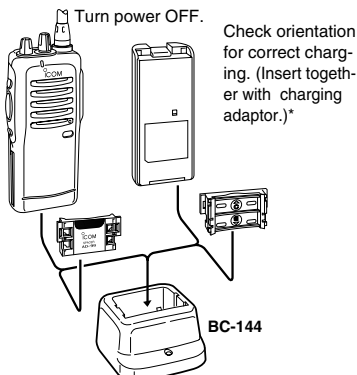

■ Charging NOTE

Prior to using the transceiver for the first time, the battery pack must be fully charged for optimum life and operation.

- Recommended temperature range for charging:
+10°C to +40°C.
- Use the supplied charger or optional charger (BC-119/BC-121/BC-144 for rapid charging, BC-146 for regular charging) only. **NEVER** use other manufacturers' chargers.

The optional BP-209, BP-210 or BP-222 battery packs include rechargeable Ni-Cd (Ni-MH: BP-210) batteries and can be charged approx. 300 times. Charge the battery pack before first operating the transceiver or when the battery pack becomes exhausted.

If you want to charge the battery pack more than 300 times, the following points should be observed:

- **Avoid overcharging**—batteries must be removed from the charger to stop charging. Batteries should not be charged for more than 24 hours.
- Use the battery until it becomes almost completely exhausted under normal conditions.

◆ Battery pack life

When the operating period becomes extremely short even after charging the battery pack fully, a new battery pack is needed.

NOTE for the rapid chargers : The charger rapidly charges a battery pack to a specified level, not a completed level, to prevent overcharging. Leave the battery pack in the charger for a few more hours (up to 15 hours; depending on battery condition) after the LED indicator turns green, to charge the battery completely.

■ Battery case (Option)

When using a BP-208 OPTIONAL BATTERY CASE attached to the transceiver, install 6 AA (R6) size alkaline batteries as illustrated below.

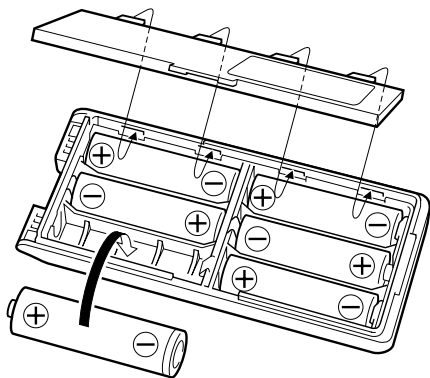

◆ CAUTIONS

- Use **ALKALINE** batteries only.
- **Make sure** all battery cells are the same brand, type and capacity.
- **Never** mix old and new batteries.
Either of the above may cause a fire hazard or damage the transceiver, if ignored.
- **Never** incinerate used battery cells since internal battery gas may cause them to rupture.
- **Never** expose a detached battery case to water.
If the battery case gets wet, be sure to wipe it dry before using it.

3 BASIC OPERATION

■ Receiving and transmitting

CHARGE the battery pack before first operating the transceiver. The transceiver has been pre-programmed with all the PMR frequency channels and CTCSS tone codes as a default. The CTCSS tone number can be changed if required.

Receiving:

- ① Rotate the [VOL] knob clockwise to turn the power ON.
- ② Rotate the [CH] selector to select the desired operating channel.
 - Setting the your group code number if required. (pgs. 14–16)
- ③ Listen for a transmission and adjust [VOL] to a comfortable listening level.
 - [LED] turns to green, when the received signal contains same CTCSS or DTCS code number.
 - When no transmission is heard, push and hold [MONI] while adjusting [VOL].

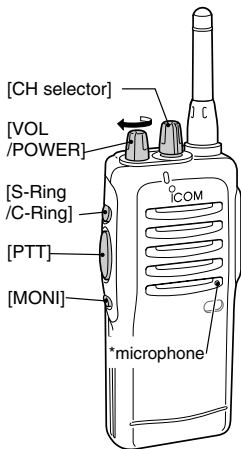

The transceiver is now set to receive desired calls on the selected channel.

Transmitting:

Wait for the channel to become clear to avoid interference.

- ④ While pushing and holding [PTT], speak into the microphone at a normal voice level.
 - [LED] turns to red.
- ⑤ Release [PTT] to return to receive.

***IMPORTANT:** To maximize the readability of your transmitted signal, pause a few sec. after pushing [PTT], hold the microphone 10 to 15 cm from your mouth and speak at a normal voice level.

• **Frequency channel/CTCSS tone list (default)**

Channel	RX/TX Freq. (MHz)*¹	CH spacing	Tone (Hz)*²
No.1	446.00625	Narrow	NO
No.2	446.01875	Narrow	NO
No.3	446.03125	Narrow	NO
No.4	446.04375	Narrow	107.2
No.5	446.05625	Narrow	110.9
No.6	446.06875	Narrow	114.8
No.7	446.08125	Narrow	118.8
No.8	446.09375	Narrow	123.0
No.9	446.00625	Narrow	127.3
No.10	446.01875	Narrow	131.8
No.11	446.03125	Narrow	136.5
No.12	446.04375	Narrow	141.3
No.13	446.05625	Narrow	146.2
No.14	446.06875	Narrow	151.4
No.15	446.08125	Narrow	156.7
No.16	Auto Scan	-----	-----

*¹: All operating channel frequencies are fixed.

*²: CTCSS tone frequencies can be programmed by you. You can use DTCS (Digital Tone Code Squelch) instead of CTCSS. (p. 17)

■ Setting squelch level

The squelch circuit mutes the received audio signal depending on the signal strength.

- ① While pushing and holding [PTT] and [MONI], turn the transceiver's power ON to enter the squelch adjustment mode.
- ② Push [S-Ring/C-Ring] to increase the squelch level (tight squelch) or [MONI] to decrease the squelch level (loose squelch).

- Squelch level will be fixed after 1 sec.

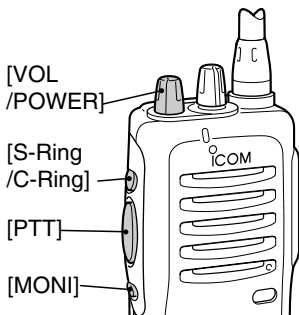

◇ *Open the squelch*

- Pushing and holding [MONI] cancels the squelch function. You can receive any signals on a channel.
- Push [MONI] to turn ON the tone squelch function again.

■ Auto Scan function

Auto scan function proceeds in sequence from lower channel to higher channel numbers. Scanning searches for signals automatically and makes it easier to locate new stations for contact or listening purposes.

- ① Rotate the [CH] select knob to CH 16.
- ② Scan starts automatically.
 - TX/RX indicator LED blinks green slowly.
 - When receiving a signal, scan pauses until the signal disappears.

CONVENIENT: You can perform the scan start/stop by the optional HM-75A SPEAKER-MICROPHONE [Mic A] key.

■ Setting the group code number

◆ USING THE CTCSS TONE CODE

The transceiver is equipped with 52 CTCSS tones. (See next page) CTCSS operation provides communication with silent standby since you will only receive calls from group members using the same CTCSS tone.

You can assign a different tone to CH 1 to CH 15 independently.

- ① While pushing and holding [PTT], [S-Ring/C-Ring], [MONI], turn [VOL] to turn the power ON.
- ② Select the desired CH 1 to CH 15 that you want to assign the CTCSS tone frequency to.
- ③ Push and hold [S-Ring/C-Ring] until a beep (Pi) is emitted.
- ④ Push [PTT] the necessary number of times to choose the 10 digit of the desired code from the channel list.
- ⑤ Push [S-Ring/C-Ring].
 - Confirmation beep is emitted. (See next page.)
- ⑥ Push [PTT] the necessary number of times to choose the 1 digit of the desired code from the frequency list.
- ⑦ Push [S-Ring/C-Ring].
- ⑧ Turn the power OFF, and then ON again.

[Example]

To assign tone code No. 28 as CH1;

- ① While pushing and holding [PTT], [S-Ring/C-Ring] and [MONI], turn [VOL] to power ON.
- ② Select the CH 1, then push and hold [S-Ring/C-Ring] until a beep (Pi) is emitted.
- ③ Push [PTT] twice to choose the 10 digit of the desired channel.
- ④ Push [S-Ring/C-Ring], then push [PTT] eight times to choose the 1 digit of the desired code.
- ⑤ Push [S-Ring/C-Ring]. A long beep and 3 short beeps are emitted.
- ⑥ Turn the power OFF, and then ON again.

3 BASIC OPERATION

• CTCSS tone code list

 : EIA/TIA standard code (Recommended to use these.)

No.	Freq.	No.	Freq.	No.	Freq.	No.	Freq.
0	OFF	16	107.2	32	171.3	48	233.6
1	67.0	17	110.9	33	173.8	49	241.8
2	69.3*	18	114.8	34	177.3	50	250.3
3	71.0	19	118.8	35	179.9	51	254.1
4	71.9	20	123.0	36	183.5	52	270.4
5	74.4	21	127.3	37	186.2		
6	77.0	22	131.8	38	189.9		
7	79.7	23	136.5	39	192.8		
8	82.5	24	141.3	40	196.6		
9	85.4	25	146.2	41	199.5		
10	88.5	26	151.4	42	203.5		
11	91.5	27	156.7	43	206.5		
12	94.8	28	159.8	44	210.7		
13	97.4	29	162.2	45	218.1		
14	100.0	30	165.5	46	225.7		
15	103.5	31	167.9	47	229.1		

*Reserved for Smart-Ring function

(Unit: Hz)

• Confirmation beep list

Push [PTT]	Confirmation beep	Push [PTT]	Confirmation beep
no	●	5 (Fifth)	●●●●●
1 (Once)	●	6 (Sixth)	●
2 (Twice)	●●	7 (Seventh)	●●
3 (Third)	●●●	8 (Eighth)	●●●
4 (Fourth)	●●●●	9 (Ninth)	●●●●

●; Single beep

 ; Long beep

◇ CTCSS FIND

This transceiver can detect the CTCSS tone frequency in the received signal. By monitoring a signal that is being transmitted from the other station, you can determine the tone frequency required to communicate with them.

This function very useful when you are going to communicate with unknown CTCSS code number stations. 'CTCSS FIND' scans all of the CTCSS codes, then stops when a tone code is detected.

- ① While pushing and holding [S-Ring/C-Ring], [MONI], turn [VOL] to turn the power ON.
- ② Select the desired CH 1 to CH 15 that you want to assign the CTCSS tone code.
- ③ Push and hold [S-Ring/C-Ring] until a beep (Pi) is emitted.
 - 'CTCSS FIND' starts to scan the code.
- ④ 'CTCSS FIND' stops when the tone code is detected.
- ⑤ Push [S-Ring/C-Ring] to determine the tone code number.
- ⑥ Turn the power OFF, and then ON again.

◇ Turn the squelch function ON/OFF

- Push and hold [MONI] to turn the tone squelch function OFF.
- You can receive any signals on a channel, when you receive the other group's signal.
- Push [MONI] to turn ON the tone squelch function again. You can receive only signals containing the same as your group code.

3 BASIC OPERATION

◆ USING THE DTCS CODE

This transceiver is equipped with 83 DTCS codes. DTCS operation provides communication with silent standby since you will only receive calls from group members using the same DTCS number. You can assign different numbers to CH 1 to CH 15 independently.

- ① While pushing and holding [PTT], [S-Ring/C-Ring] and [MONI], turn [VOL] to turn the power ON.
- ② Select the desired CH 1 to CH 15 that you want to assign the DTCS code to.
- ③ Push and hold [MONI] until a beep (Pi) is emitted.
- ④ Push [PTT] the necessary number of times to choose the 100 digit of the desired code number.
- ⑤ Push [S-Ring/C-Ring].
 - Confirmation beep is emitted. (See p. 15)
- ⑥ Push [PTT] the necessary number of times to choose the 10 digit of the desired code number.
- ⑦ Push [S-Ring/C-Ring].
 - Confirmation beep is emitted. (See p. 15)
- ⑧ Push [PTT] the necessary number of times to choose the 1 digit of the desired code number.
- ⑨ Push [S-Ring/C-Ring].
 - Confirmation beep is emitted. (See p. 15)
- ⑩ Push [PTT] once more, if you want to use **Inverse** mode.
- ⑪ Push [S-Ring/C-Ring] to complete the setting.
 - Confirmation beep is emitted. (See p. 15)
- ⑫ Turn the power OFF, and then ON again.

[Example]

To assign code '2611 (**Inverse**)' as CH12;

- ① While pushing and holding [PTT], [S-Ring/C-Ring], [MONI], turn [VOL] to turn the power ON.
- ② Select CH 12.
- ③ Push and hold [MONI] until a beep (Pi) is emitted.
- ④ Push [PTT] twice to choose the 100 digit of the code number.
- ⑤ Push [S-Ring/C-Ring].
 - Confirmation beep is emitted. (See p. 15)
- ⑥ Push [PTT] six times to choose the 10 digit of the code number.
- ⑦ Push [S-Ring/C-Ring].
 - Confirmation beep is emitted. (See p. 15)
- ⑧ Push [PTT] once to choose the 1 digit of the code number.
- ⑨ Push [S-Ring/C-Ring].
 - Confirmation beep is emitted. (See p. 15)
- ⑩ Push [PTT] once more, to use **Inverse** mode.
 - *You can skip step ⑩, if you want to use **Normal** mode.
- ⑪ Push [S-Ring/C-Ring] to complete the setting.
 - Confirmation beep is emitted. (See p. 15)
- ⑫ Turn the power OFF, and then ON again.

- DTCS code list (EIA/TIA standard code)

023	071	134	223	306	411	503	631	734
025	072	143	226	311	412	506	632	743
026	073	152	243	315	413	516	654	754
031	074	155	244	331	423	532	662	
032	114	156	245	343	431	546	664	
043	115	162	251	346	432	565	703	
047	116	165	261	351	445	606	712	
051	125	172	263	364	464	612	723	
054	131	174	265	365	465	624	731	
065	132	205	271	371	466	627	732	

4 RING FUNCTION

■ Smart-Ring

The ring function has an answer back feature. This allows you to confirm whether or not a call has reached the member of your group even if the operator is temporarily away from the transceiver.

◆ Smart-Ring operation (see right)

- ① Set the same operating channel and CTCSS tone* code for all of your group transceivers.
- ② Push [S-Ring/C-Ring] to send the Smart-Ring call.
 - When a member of your group station answers your call, then the transceiver emits beep tones for every 30 sec. and TX/RX indicator blinks with an orange color.
 - Push [MONI] to cancel the Ringer beep and indication.
 - When no answer comes back, the transceiver emits short failure beep tones.
- ③ Push [PTT] to answer the call and to stop the beeps and blinking.

***NOTE:** This function is available only when the called station has use the same CTCSS tone code and the same operating channels as you.

■ Call-Ring

Sends the pre-selected ring tone to your group members.

◆ Select the Call-Ring melody

- ① While pushing and holding [PTT] and [S-Ring/C-Ring], rotate [VOL] to turn the power ON.
 - A sample melody is emitted.
- ② Rotate [CH] to select the ringer melody.
 - Push [S-Ring/C-Ring] to monitor the selected melody once more.
- ③ Turn the power OFF to determine the melody.

• Smart-Ring operation

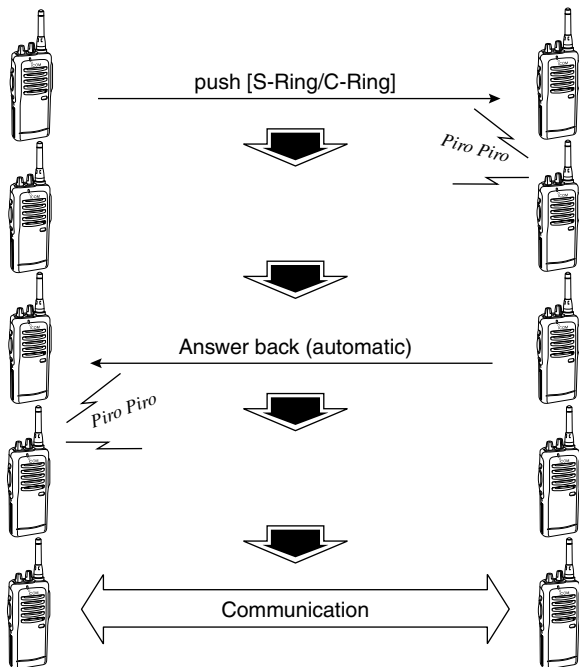

◇ Call your group member with Call-Ring melody

- Pushing and holding [S-Ring/C-Ring] to sends a ring tone without pushing [PTT].
 - The ring tone is emitted while the [S-Ring/C-Ring] key is pressed.
 - The same ring tone comes from your group station's speaker.

5 OTHER FUNCTIONS

■ Monitor audible function

The monitor function allows you to open the transceiver's squelch manually to check whether a channel is busy or not. The transceiver has 2 conditions for receive standby:

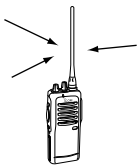

All signals are received

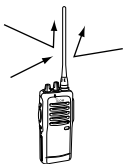

Only signals containing the proper tone are received

- **Audible condition:**

This condition mutes audio **ONLY** when no carrier is present. You can receive (or monitor) any signals on a channel.

- Push and hold the [MONI] switch to cancel the CTCSS or DTCS tone squelch function.

Any audio mute functions are cancelled while pushing the [MONI] switch.

- **Inaudible condition:** This condition mutes **ALL** signals except those directed to you. Therefore you should check a channel's condition (busy or not) with the monitor function before transmitting.

- Push the [MONI] switch momentarily to select the inaudible condition.

■ Time-Out Timer

The transceiver has time-out timer function. This function prevents continuous, extend transmissions. This timer automatically turns a transmission OFF 3 min. after it starts.

A warning beep emits 10 sec. before the limit is reached.

The end beep emits 5 times to announce the end of the transmission.

■ Power save function

The power save function reduces the current drain to conserve battery power.

- The power save function is automatically turned ON when no operation is performed or no signal is received for 5 sec.

■ Low battery indication

The TX/RX LED indicates 4 levels of the “Low battery” condition as follows.

If the “Low battery” warning appears during operation, please charge or replace the battery.

[Brink patterns]

- Low BATT1: You should charge the battery. (blinks slowly)



- Low BATT2: You must charge the battery. (blinks fast)

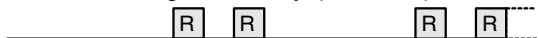

- TX low BATT1: Low BATT1 was detected during TX mode.



- TX low BATT2: Low BATT2 was detected during TX mode.



In an extreme low temperature surrounding (around -20°C), the capacity of the battery may exhaust quickly (especially Alkaline batteries). In such case, we recommend to charge the battery or replace the batteries, when the “Low Battery” Indication appears during operation.

5 OTHER FUNCTIONS

■ Optional HM-75A functions

The optional HM-75A allows you to remotely send Smart-Ring/Call-Ring calls, open the squelch, etc. The switches on the HM-75A function as follows.

CAUTION: When connecting the HM-75A to the transceiver, make sure that the transceiver is turned OFF, otherwise the transceiver may malfunction.

Key	Push	Push and hold
Mic UP	Sends Smart-Ring.	Sends Call-Ring.
Mic DOWN	Turn the Tone Squelch ON.	Turn the Tone Squelch OFF.
Mic A	Start/Stop scan B.	---
Mic B	---	---

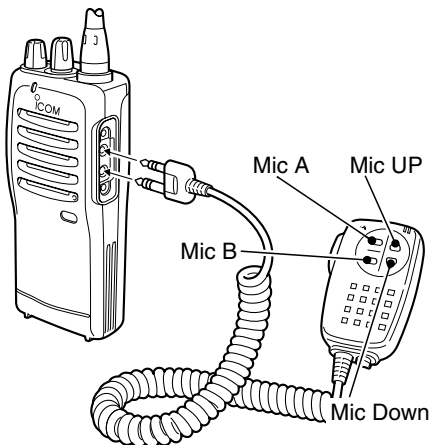

SPECIFICATIONS

6

GENERAL

- Frequency coverage : 446.00625–446.09375 MHz
- Mode : F3E (FM)
- No. of operating Ch. : 8 (simplex)
- Power supply requirement : 7.2 V (R6x6) or BP-222
- Current drain : 0.6 A approx.
- Operating temp. range : –25°C to +55°C
- No. of CTCSS freq. : 38
- Dimensions : 54(W)x128(H)x37(D) mm
(projections not included)
- Weight : 317 g (including BP-222 Ni-Cd batteries)

TRANSMITTER

- Output power : Less than 500 mW ERP
- Ext. mic. connector : 3-conductor 2.5 (d) mm/2.2 k Ω

RECEIVER

- Sensitivity : Less than 26.5 dB μ V/m
(20 dB SINAD)
- Audio output power : More than 500 mW at 5 %
(at 7.2 V DC) distortion with an 8 Ω load
- Ext. speaker connector : 2-conductor 3.5 (d) mm/8 Ω

All stated specifications are subject to change without notice or obligation.

7 OPTIONS

Options

◇ BATTERY PACKS

- **BP-208** BATTERY CASE
Allows a set of Alkaline batteries to operate the handheld when charging the rechargeable battery or in emergencies, etc. 6 AA (R6) cells are required.
- **BP-209** Ni-Cd BATTERY PACK
7.2 V/1100 mAh Ni-Cd battery pack, allows more than 12 hours operation.
- **BP-210** Ni-MH BATTERY PACK
7.2 V/1650 mAh Ni-MH battery pack, allows approx. 18.5 hours operation.
- **BP-222** Ni-Cd BATTERY PACK
7.2 V/600 mAh Ni-Cd battery pack, allows approx. 6.5 hours operation (Same as supplied with models).

◇ CHARGER

- **BC-119** DESKTOP CHARGER + AD-94 (#11)
For rapid charging of battery packs. An AC adaptor is supplied with the charger. Charging time: 1.5 to 2 hrs.
- **BC-121** MULTI-CHARGER + AD-94 (#11)
For rapid charging up to 6 battery packs simultaneously. An AC adaptor may be supplied depending on version. Six AD-94 's (#11) are necessary. Charging time: 1.5 to 2 hrs.
- **AD-99** CHARGER ADAPTOR
- **BC-144** DESKTOP CHARGER
For rapid charging of BP-209 (Ni-Cd), BP-210 (Ni-MH) and BP-222 (Ni-Cd).
- **BC-146** DESKTOP CHARGER
For regular charging of BP-209 (Ni-Cd), BP-210 (Ni-MH) and BP-222 (Ni-Cd).

◇ OTHER OPTIONS

- **HM-46L/HM-75A/HM-131L** SPEAKER MICROPHONE
Combination speaker-microphone that provides convenient operation while hanging the transceiver from your belt.
HM-75A has programmable function key Mic UP, Mic DOWN, Mic A, Mic B.
HM-131L has moisture proof construction.
- **SP-13** EARPHONE
Provides clear receive audio in noisy environments.
- **MB-68** BELT CLIP
Same as that supplied with the transceiver.
- **MB-74** BELT CLIP
Exclusive alligator-type belt clip.
- **VS-1SL** VOX/PTT CASE
The VS-1SL has a PTT switch and VOX function. The VS-1SL must be used with an Icom headset such as the HS-94, etc.
- **HS-94** HEADSET
An ear-attachable, earphone/microphone for use with the Icom handheld transceivers. The HS-94 must be used in conjunction with the VS-1SL VOX/PTT CASE.

8 GLOSSARY

✓ *What is squelch?*

A squelch circuit allows you to mute undesired noise while receiving no signal and emit audio while receiving signals.

This provides quiet standby. The [MONI] key cancels the squelch setting. This is useful to listen to weak signals that do not open the squelch.

✓ *Talk Range*

The IC-F22SR is designed to maximize performance and improve transmission range in the field. However, the single most important factor in transmit range (talk power) is your surrounding environment. These radios are “line of sight” radios and as such, transmission range is influenced by the degree to which you can “see” the other communicating party. Large concrete structures and heavy foliage or transmission from inside a building or vehicle will reduce your talk power.

- Optimal range: wide, open areas free of obstructions.
- Medium range: large buildings or trees blocking your line of sight.
- Minimum range: mountainous areas or areas of heavy foliage.

✓ **What is CTCSS (Continuous Tone Coded Squelch System) ?**

CTCSS (Continuous Tone Coded Squelch System) allows communication with silent stand by. Only signals containing your group code can open the squelch.

This conveniently eliminates unwanted audio and is useful in group activities or security related activities where unwanted output can be a problem. Note that CTCSS group mode is not private—anyone can receive your calls.

The IC-F22SR is equipped with max. 52 tone codes for CTCSS use. Selecting a code applies it to all 8 operating channels. Each push of [PTT] superimposes your group code over your transmit signal; and, only signals containing the same code can open your squelch. To temporarily hear all signals (including noise) push and hold [MONI]. Do not use CTCSS if you want to be able to hear signals on all channels.

✓ **Auto Scan function + Smart-Ring**

The Auto Scan function searches for signals automatically and makes it easier to locate new stations for contact or listening purposes. **BUT** because the Auto Scan function checks each operating channel for only a few moments, the transceiver's response accuracy to Smart-Ring calls is reduced. Use one of CH 1–15 when you and your group are going to use the Smart-Ring function, otherwise the Smart-Ring function may fail to answer-back the call.

ABOUT CE



CE Versions of the IC-F22SR which display the “CE” symbol on the serial number seal, comply with the essential requirements of the European Radio and Telecommunication Terminal Directive 1999/5/EC.



This warning symbol indicates that this equipment operates in non-harmonised frequency bands and/or may be subject to licensing conditions in the country of use. Be sure to check that you have the correct version of this radio or the correct programming of this radio, to comply with national licensing requirement.



DECLARATION OF CONFORMITY

We Icom Inc. Japan
1-1-32, Kamiminami, Hirano-ku
Osaka 547-0003, Japan

Declare on our sole responsibility that this equipment complies with the essential requirements of the Radio and Telecommunications Terminal Equipment Directive, 1999/5/EC, and that any applicable Essential Test Suite measurements have been performed.

Kind of equipment: UHF PMR TRANSCEIVER

Type-designation: IC-F22SR

Version (where applicable):

This compliances is based on conformity with the following harmonised standards, specifications or documents:

- i) EN 60950 (August 1992) + A11: 1997
- ii) EN 300 296 (March 2001)
- iii) EN 300 279 v1.2.1 (February 1999)
- iv) _____
- v) _____

CE0168!

Düsseldorf 31th July 2001

Place and date of issue

Icom (Europe) GmbH
Himmelgeister strabe 100
D-40225 Düsseldorf

Authorized representative name

T. Maebayashi
General Manager

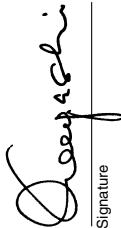
Signature

Icom Inc.

Count on us!

< Intended Country of Use >

- | | | |
|------------------------------|------------------------------|------------------------------|
| <input type="checkbox"/> GER | <input type="checkbox"/> NED | <input type="checkbox"/> ITA |
| <input type="checkbox"/> AUT | <input type="checkbox"/> BEL | <input type="checkbox"/> GRE |
| <input type="checkbox"/> GBR | <input type="checkbox"/> LUX | <input type="checkbox"/> SWE |
| <input type="checkbox"/> IRL | <input type="checkbox"/> ESP | <input type="checkbox"/> DEN |
| <input type="checkbox"/> FRA | <input type="checkbox"/> POR | <input type="checkbox"/> FIN |
| <input type="checkbox"/> SUI | | |

A-6069D -1EU-①

Printed in Japan

© 2001 Icom Inc.

Icom Inc.

1-1-32 Kamiminami, Hirano-ku, Osaka 547-0003 Japan

Download from Www.Somanuals.com. All Manuals Search And Download.

Free Manuals Download Website

<http://myh66.com>

<http://usermanuals.us>

<http://www.somanuals.com>

<http://www.4manuals.cc>

<http://www.manual-lib.com>

<http://www.404manual.com>

<http://www.luxmanual.com>

<http://aubethermostatmanual.com>

Golf course search by state

<http://golfingnear.com>

Email search by domain

<http://emailbydomain.com>

Auto manuals search

<http://auto.somanuals.com>

TV manuals search

<http://tv.somanuals.com>