



INSTRUCTION MANUAL

COMMUNICATIONS RECEIVER **IC-R8500**



IMPORTANT

READ THIS INSTRUCTION MANUAL CAREFULLY before attempting to operate the receiver.

SAVE THIS INSTRUCTION MANUAL. This instruction manual contains important safety and operating instructions for the IC-R8500.

EXPLICIT DEFINITIONS

WORD	DEFINITION
⚠ WARNING	Personal injury, fire hazard or electric shock may occur.
⚠ CAUTION	Equipment damage may occur.
NOTE	If disregarded, inconvenience only. No risk of personal injury, fire or electric shock.

CE Versions of the IC-R8500 which display the “CE” symbol on the serial number seal, comply with the essential requirements of the European Radio and Telecommunication Terminal Directive 1999/5/EC, and that any applicable Essential Test Suite measurements have been performed.

PRECAUTIONS

⚠ INDOOR USE ONLY! NEVER expose the IC-R8500 or AC adapter to rain, snow or any liquids.

⚠ NEVER connect the receiver to an AC outlet directly. This may pose a fire hazard or result in an electric shock. Always use the supplied AC adapter or connect to a 13.8 V DC power source.

⚠ NEVER connect to an AC outlet that exceeds the suggested voltage for each AC adapter version. This could cause a fire or ruin the AC adapter and/or receiver.

⚠ NEVER use non-rated fuses. Non-rated fuses could cause a fire or ruin the receiver.

NEVER let metal, wire or other objects touch any internal part or connectors on the rear panel of the receiver. This will cause electric shock.

AVOID using or placing the receiver in areas with temperatures below -10°C ($+14^{\circ}\text{F}$) or above $+50^{\circ}\text{C}$ ($+122^{\circ}\text{F}$).

AVOID placing the receiver in excessively dusty environments or in direct sunlight.

AVOID placing the receiver against walls or putting anything on top of the receiver. This will obstruct heat dissipation.

RESPECT other people’s privacy. Information overheard but not intended for you cannot lawfully be used in any way.

UNPACKING

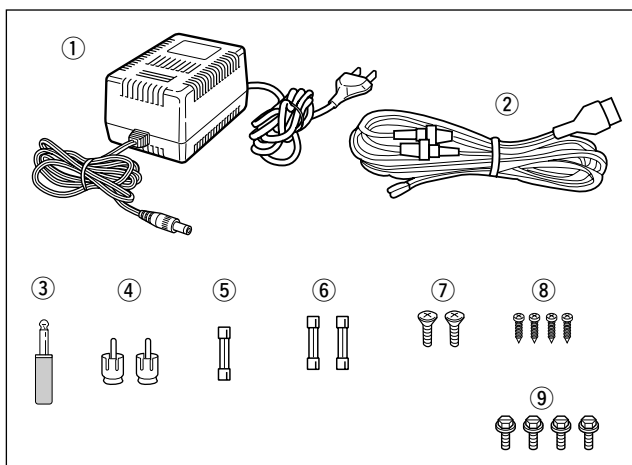

Accessories included with the IC-R8500:

	Qty.
① AC adapter (AD-55A)*	1
② DC power cable (OPC-023C)	1
③ Mini plug (2-conductor, 3.5d)	1
④ Phono (RCA) plugs	2
⑤ Fuse (FGMB 125 V 3 A; internal use)	1
⑥ Fuses (FGB 3 A; for DC cable)	2
⑦ Screws (M4 x 12 for optional MB-23)	2
⑧ Screws (C0 3 x 8 for optional MB-23 feet)	4
⑨ Allen bolts (M5 x 8 for optional IC-MB12)	4

*Some versions are not supplied with an AC adapter.

TABLE OF CONTENTS

IMPORTANT	i	8 SET MODE	30
EXPLICIT DEFINITIONS	i	■ General	30
PRECAUTIONS	i	■ Quick set mode items	31
UNPACKING	i	■ Initial set mode items	31
TABLE OF CONTENTS	ii	9 CONNECTOR INFORMATION	33–34
1 PANEL DESCRIPTION	1–6	10 CONTROL COMMANDS	35–36
■ Front panel	1	■ Command table	35
■ Rear panel	5	■ Data format	35
■ Function display	6	11 MAINTENANCE	37
2 CONNECTIONS	7–10	■ Disassembly	37
■ Mounting installation	7	■ Fuse replacement	37
■ Required connections	8	■ Level adjustments	37
■ Antenna connection	9	■ Memory backup	37
■ Grounding	9	■ CPU resetting	37
■ Tape recorder connections	10	■ Cleaning	37
■ Transceive function	10	12 OPTIONAL INSTALLATIONS	38–39
■ Connecting to a PC	10	■ UT-102 VOICE SYNTHESIZER UNIT	38
■ Data demodulation terminal	10	■ FL-52A CW NARROW FILTER	38
3 FREQUENCY SETTING	11–12	■ CR-293 HIGH STABILITY CRYSTAL UNIT	39
■ Read me first	11	13 TROUBLESHOOTING	40–41
■ Using the keypad	11	14 SPECIFICATIONS	42
■ Using the main dial	12	15 OPTIONS	43
■ Lock function	12	16 DOC	44
4 RECEIVE FUNCTIONS	13–16		
■ Initial settings	13		
■ Mode selection	13		
■ Squelch function	14		
■ Functions for FM	14		
■ Functions for SSB/CW	14		
■ Data communications	16		
5 MEMORY CHANNELS	17–22		
■ General	17		
■ Bank selection	17		
■ Channel selection	18		
■ Programming	19		
■ Copy and paste (memory editing)	19		
■ Clearing	19		
■ Channel/bank names	20		
■ Assigning channels numbers	21		
6 SCANS	23–28		
■ Operation	23		
■ Mode select function	25		
■ Specifying skip channel and frequency	25		
■ Automatic bank limit/skip functions	26		
■ Voice scan control function	26		
■ Programming scan edge frequencies	27		
■ Scan speed/delay functions	27		
7 SLEEP TIMER	29		

■ Front panel

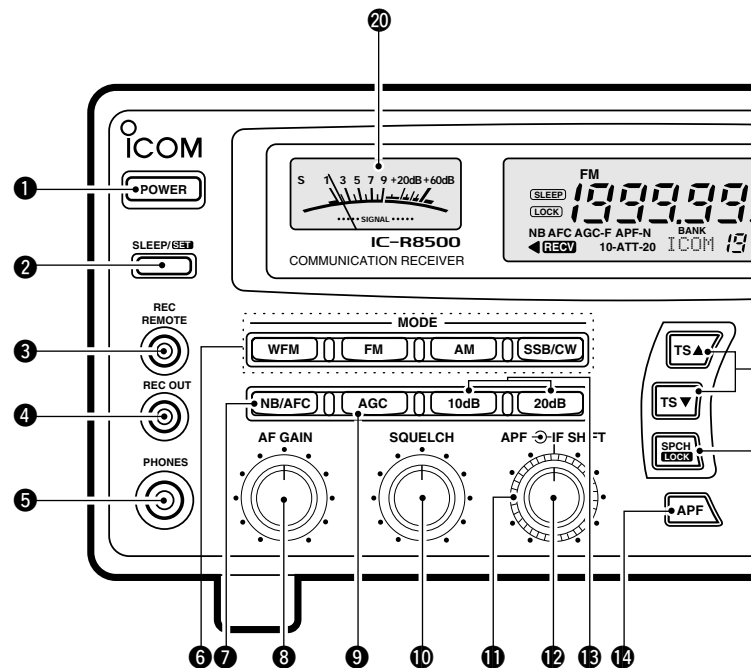

❶ POWER SWITCH [POWER]

Turns power ON and OFF.

❷ SLEEP/SET SWITCH [SLEEP/SET]

- ➔ Push momentarily to set the sleep timer (p. 29).
 - Selectable times are 30, 60, 90, 120 min. or OFF.
 - “[SLEEP]” appears in the function display when the sleep timer is set.
- ➔ Push for 1 sec. to enter quick set mode (p. 30).
 - Use the [M-CH] selector and main dial to select items and contents, respectively.

❸ RECORDER REMOTE JACK [REC REMOTE] (p. 10)

Controls the running of a tape recorder for recording. Connects to the REMOTE jack on a tape recorder.

❹ RECORDER JACK [REC OUT] (p. 10)

Outputs an audio signal. Connect to the AUX or LINE IN jack on a tape recorder.

❺ HEADPHONE JACK [PHONES]

Accepts headphones with 4–16 Ω impedance.

- When headphones are connected, no receive audio comes from the speaker.
- Stereo headphones can be connected, however, output is monaural.

❻ MODE SWITCHES [WFM]/[FM]/[AM]/[SSB/CW] (p. 13)

- ➔ Push to select an operating mode.
 - The following keys toggle between several modes:
 - [FM] FM, FM narrow
 - [AM] AM, AM narrow, AM wide
 - [SSB/CW] USB, LSB, CW, optional CW narrow
- ➔ When SSB/CW mode is selected, push [SSB/CW] for 1 sec. to adjust the BFO frequency. (p. 15).

❼ NOISE BLANKER/AFC SWITCH [NB]/[AFC]

Activates the noise blanker function or automatic frequency control function.

- The noise blanker is used for removing pulse-type noise when SSB, CW or AM mode is selected (p. 15).
- The automatic frequency control tunes the displayed frequency automatically when an off-center frequency is received. It activates when FM or WFM is selected (p. 14).

❽ AUDIO FREQUENCY GAIN CONTROL [AF GAIN] (p. 13)

Rotate clockwise to increase the audio output; rotate counterclockwise to decrease the audio output.

❾ AUTOMATIC GAIN CONTROL [AGC] (p. 15)

Toggles the time constant of the AGC circuit between “slow” and “fast.”

- When “fast” is selected, “AGC-F” appears.
- Cannot be used in FM or WFM modes.

❿ SQUELCH CONTROL [SQUELCH] (p. 14)

Varies the squelch threshold level (to mute noise when receiving no signal).

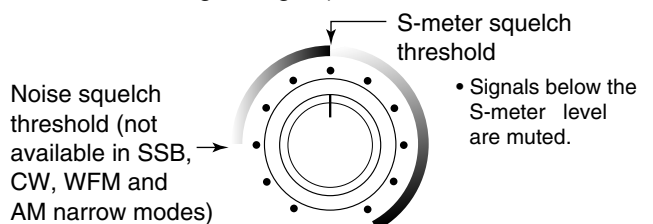

⓫ IF SHIFT CONTROL [IF SHIFT] (p. 14)

Shifts the center frequency of the receiver's IF pass-band to reject interfering signals.

- Cannot be used in FM, WFM and AM modes.

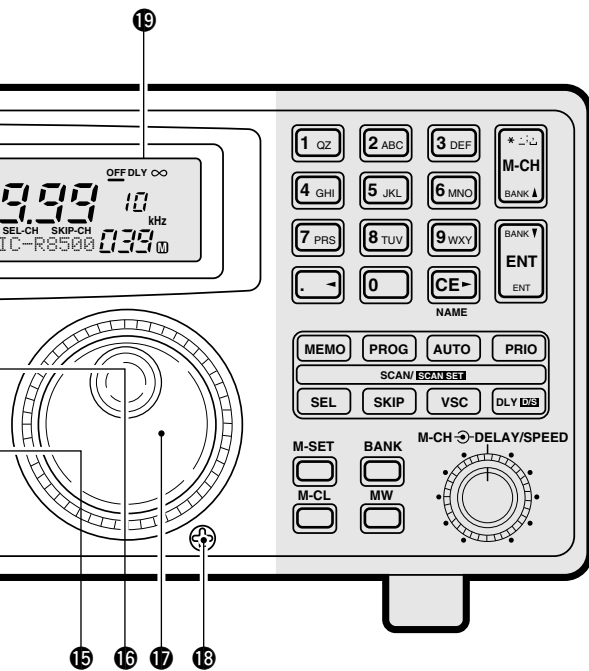

Center frequency is shifted down.

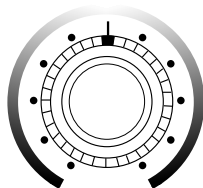

Center frequency is shifted up.

12 AUDIO PEAK FILTER CONTROL [APF] (p. 15)

Adjusts the audio peak filter setting to pick up a desired audio frequency. Only valid when the [APF] switch is ON.

- Clockwise rotation adjusts the filter setting higher; counterclockwise rotation adjusts the filter setting lower.

13 ATTENUATOR SWITCHES [10dB]/[20dB]

Push to activate one of the attenuators.

- ▶ Push [10dB] to activate the 10 dB attenuator.
- ▶ Push [20dB] to activate the 20 dB attenuator.
- ▶ Push [10dB]+[20dB] to activate the 30 dB attenuator.
- 10 dB and 30 dB attenuator cannot be used below 500 kHz.

14 AUDIO PEAK FILTER SWITCH [APF] (p. 15)

▶ Push momentarily to toggle the audio peak filter circuit ON and OFF.

- Use the [APF] control to adjust the center of the audio peak passband.
- ▶ When the audio peak filter circuit is ON, push for 1 sec. to toggle the filter setting between *normal* and *narrow*.
- ‘Narrow’ is available for SSB, CW and AM only.

15 SPEECH/LOCK SWITCH [SPCH/LOCK]

▶ Push momentarily to activate the voice synthesizer function and have the displayed frequency announced.

- An optional UT-102 SPEECH SYNTHESIZER UNIT is necessary to activate the voice synthesizer function (p. 38).

- Automatic announcement at signal detection during scan is available. Refer to the “REC SPCH” item on p. 31 for details.

▶ Push for 1 sec. to activate the lock function (p. 12).

- Push for 1 sec. again to cancel the lock function.
- The lock function action can be selected in set mode to cover the main dial only, or to cover both the main dial and front panel switches.

16 TUNING STEP SWITCHES [TS▲]/[TS▼] (p. 12)

Select the tuning step for the main dial. Push [TS▲] to select a larger tuning step; push [TS▼] to select a smaller tuning step.

- 10 Hz, 50 Hz, 100 Hz, 1 kHz, 2.5 kHz, 5 kHz, 9 kHz, 10 kHz, 12.5 kHz, 20 kHz, 25 kHz, 100 kHz and 1 MHz are selectable.
- Programmable tuning steps can be set between 0.5 and 199.5 kHz.
- ▶▶ To set programmable tuning steps, enter the desired steps via the keypad, then push [TS▲] or [TS▼].

17 MAIN DIAL

Changes the operating frequency, set mode contents, etc.

18 BRAKE ADJUSTMENT SCREW

Adjusts the main dial tension.

19 FUNCTION DISPLAY (p. 6)

Shows the selected frequency, mode, memory name, etc.

20 S-METER

- ▶ Shows the strength of the received signal.
- ▶ Shows the squelch threshold level when the [SQUELCH] is rotated past the center position.

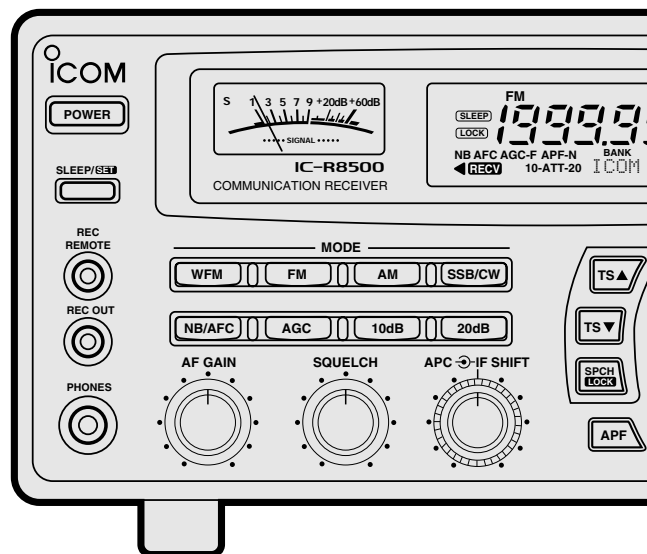

21 MEMORY SET SWITCH [M-SET] (p. 19)

Used to 'copy and paste' the displayed frequency into another memory channel.

- The first push is used to copy (M appears), and the second push is used to paste (M disappears).
- Frequency, mode, tuning step, memory name, etc. can be programmed into a temporary memory.

22 MEMORY CLEAR SWITCH [M-CL] (p. 19)

Push and hold to clear the contents of the displayed memory.

- Bank names cannot be cleared.

23 MEMORY WRITE SWITCH [MW] (p. 19)

Push and hold to store the displayed frequency, mode, tuning step, etc. into the selected memory channel.

24 BANK SWITCH [BANK] (p. 17)

- ➔ Push momentarily to toggle the bank limit function ON and OFF (p. 18).
 - While "BANK" appears, only memory channels within the selected bank can be selected via the [M-CH] selector.
- ➔ Push for 1 sec. to increase/decrease the number of memory channels in the selected bank (p. 21).

25 MEMORY CHANNEL SELECTOR [M-CH] (p. 18)

- ➔ Selects a memory channel in normal use.
 - Clockwise rotation selects higher memory channel numbers; counterclockwise rotation selects lower memory channel numbers.
- ➔ Selects a set mode item when quick set mode or initial set mode is selected (p. 30).

26 DELAY/SPEED CONTROL [DELAY/SPEED] (p. 28)

Adjusts the scan delay time or scan speed depending on the [DLY **D/S**] switch setting.

- When scan delay time is assigned, this control adjusts the scan delay time (scan pausing interval) during signal reception. This setting is effective when "OFF **DLY** ∞" is selected for the scan resume condition.
- When scan speed is assigned, this control adjusts the scan speed. In this case, scan delay time is determined while setting.

27 SCAN SWITCHES [SCAN **SCAN SET**]

All of these switches are related to the scan function in some way as follows:

[MEMO] (p. 23)

- ➔ Push momentarily to start/stop memory scan.
- ➔ Push numeral keys, then this key to start memory scan in the specified bank.
- ➔ Push this key, then a mode switch to activate mode select scan function.
- ➔ Push for 1 sec. to set automatic bank and skip functions.
 - The bank limit function and/or memory skip functions are activated automatically when "AUTO" is selected and scan is started.

[SEL] (p. 23)

- ➔ Push momentarily to start/stop memory select scan.
- ➔ Push for 1 sec. to set the memory channel as a *select* channel.

[PROG] (p. 24)

- ➔ Push momentarily to start/stop programmed scan.
- ➔ Push numeral keys, before or after pushing this key to start programmed scan using the specified scan edge group.
 - 10 scan edge groups are available.
- ➔ Push for 1 sec. to program scan edges for programmed scan.

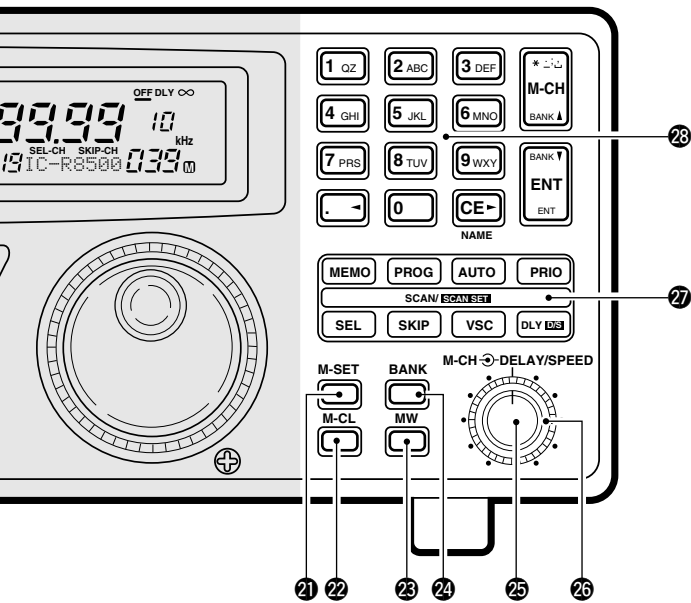

[SKIP] (p. 25)

- Push momentarily to toggle the skip function ON and OFF for any scan.
 - Automatic skip activation is available with the [MEMO] switch.
- Push for 1 sec. to set the memory channel as a skip channel.

[AUTO] (p. 24)

- Push momentarily to start/stop auto write scan.
- Push for 1 sec. to select the written memories condition for the auto write scan.
 - Two conditions are available, clear auto-written memories before scan starts; and, keep auto written memories before scan start.

[VSC] (p. 26)

- Push to toggle the voice scan control function ON and OFF.
- The VSC function resumes the scan when a detected signal does not contain voice components.
 - "VSC" appears while the voice scan control function is activated.

[PRIO] (p. 25)

- Push momentarily to start/stop priority scan.
 - Priority scan can be used in combination with other scans.
- Push for 1 sec. to enter the priority channel programming condition.

[DLY D/S] (p. 27)

- Push momentarily to select a scan resume condition.
 - ▶ "OFF" is underscored: scan pauses on a signal until it disappears, then resumes 3 sec. after that.
 - ▶ "DLY" is underscored: scan resumes according to the [DELAY/SPEED] control setting. When a signal disappears, scan resumes 3 sec. later.

- ▶ "∞" is underscored: scan is cancelled when receiving a signal.
- Push for 1 sec. to enter the delay time/scan speed setting condition.
 - The function of the [DELAY/SPEED] control can be selected.

28 KEYPAD

- The keypad can be used for several functions as below:
- Keypad then [ENT] (then [MW])
 - Direct frequency input.
 - Keypad then [M-CH]
 - Memory channel selection.
 - [CE • NAME] then keypad
 - Alphanumeric input for memory, bank names, etc.
 - Keypad then [TS▲] or [TS▼]
 - Arbitrary tuning step setting.
 - Keypad then [MEMO] or [SEL]
 - Specify memory bank then start memory scan or select memory scan.
 - Keypad then [PROG] or [AUTO]
 - Specify scan edge group, then start programmed scan or auto write scan.

■ Rear panel

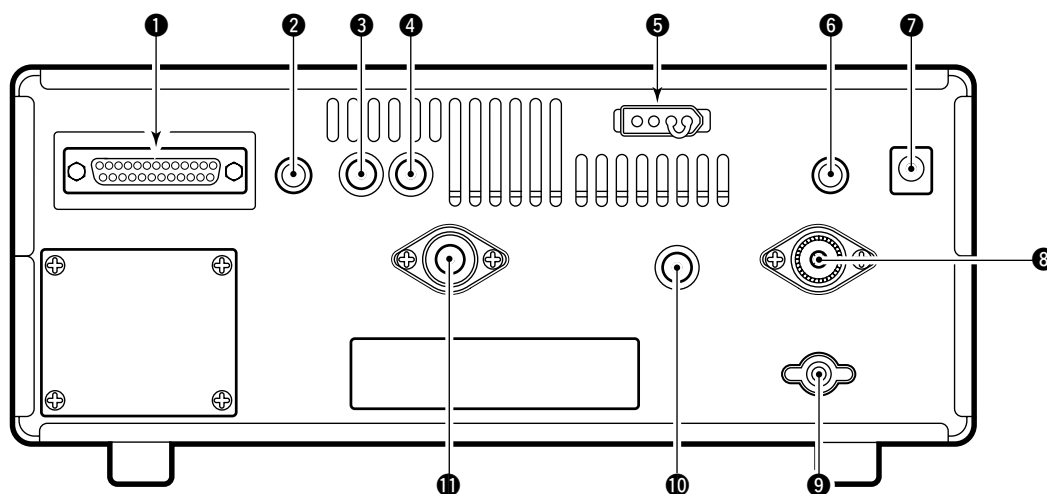

❶ RS-232C CONNECTOR (p. 10)

Connects an RS-232C cable. An RS-232C cable can be used to connect the IC-R8500 to a PC. In this way commands can be sent to the receiver via the PC.

❷ CI-V REMOTE CONTROL JACK (p. 10)

Allows connection to an Icom CI-V system transceiver or another receiver for the transceive function. Also connects to a PC with several receivers for command control via an optional CT-17 CI-V LEVEL CONVERTER.

❸ IF OUT JACK

Outputs a 10.7 MHz IF signal with 9 V DC for an external equipment.

❹ AGC JACK (p. 16)

This jack has functions which are selectable through internal receiver settings.

- Outputs an AGC signal for an external equipment (default).
- Outputs audio detected signal without de-emphasis for 9600 bps data detection (FM mode only).

❺ DC 13.8 V JACK (p. 8)

- ➔ Plug in the jumper connector here when using the supplied* AC adapter.
- ➔ Connects to a 13.8 V DC power source using the supplied DC cable when the AC adapter is not connected.

*Not supplied with some versions.

❻ EXTERNAL SPEAKER JACK

Connects an 8 Ω external speaker.

- When an external speaker is connected, the internal speaker does not function.

❼ DC IN JACK (p. 8)

Connects the supplied* AC adapter.

- A regulator circuit has been designed between this connector and the DC 13.8 V jack.
- Be sure the jumper connector is connected to the DC 13.8 V jack.

*Not supplied with some versions.

❽ HF 50 Ω ANTENNA CONNECTOR (p. 8)

Connects an antenna to cover the frequency range below 30 MHz.

- Use a coaxial cable and a PL-259 connector.
- Be sure this connector is selected in quick set mode (p. 31).

❾ GROUND TERMINAL (p. 9)

Connect this terminal to a ground.

❿ HF 500 Ω ANTENNA CONNECTOR (p. 8)

When a 500 Ω long wire antenna is used for HF band receiving, this connector is used instead of the 50 Ω antenna connector.

- Set the "HF ANT" item to 500 to use this connector (p. 31).

⓫ VHF/UHF ANTENNA CONNECTOR (p. 8)

Connects an antenna to cover the frequency range over 30 MHz.

- Use a coaxial cable and type-N connector.

■ Function display

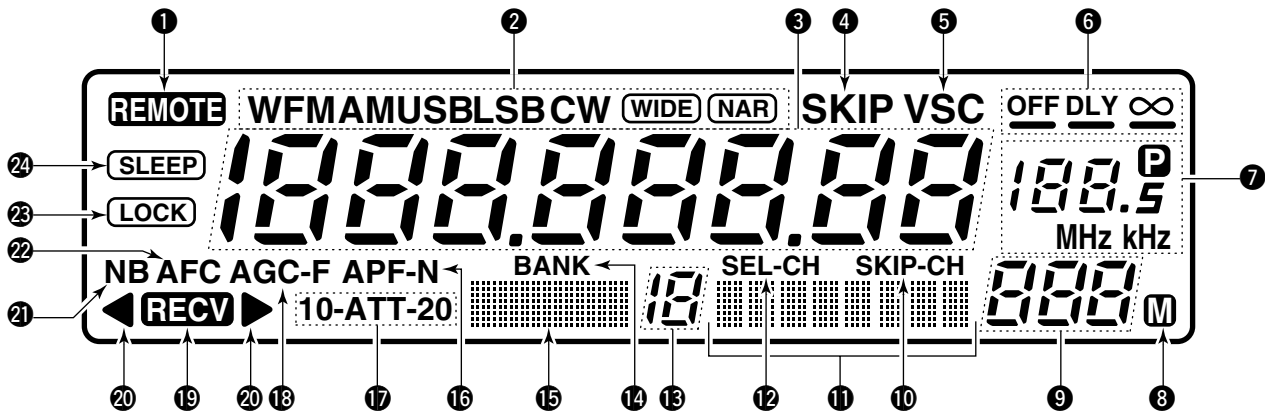

- 1 REMOTE INDICATOR** (p. 35)
Appears when a level control command is received from a PC via CI-V data.
•When this indicator appears, the control knob's setting is ignored.
•This indicator will disappear when the control knob is rotated.
- 2 MODE INDICATORS** (p. 13)
Show the operating mode.
- 3 FREQUENCY READOUT**
Shows the operating frequency.
- 4 SKIP INDICATOR** (p. 25)
➤ Appears when the skip function is activated.
➤ Flashes during scan when the skip function is activated by the auto skip function.
- 5 VSC INDICATOR** (p. 26)
Appears when the voice scan control function is activated.
- 6 SCAN RESUME CONDITION INDICATORS** (p. 27)
Show the selected scan resume condition.
- 7 TUNING STEP INDICATORS** (p. 12)
Show the selected tuning step.
•“P” appears when a programmable tuning step is selected.
- 8 TEMPORARY MEMORY INDICATOR** (p. 19)
➤ Appears when [M-SET] is pushed to indicate that a frequency is being temporarily saved.
➤ Disappears when the temporary memory is pasted into another memory channel.
- 9 MEMORY CHANNEL READOUT** (p. 17)
Shows the selected memory channel number.
- 10 SKIP CHANNEL INDICATOR** (p. 25)
Appears when the selected memory channel is set as a skip channel.
- 11 MEMORY NAME INDICATORS** (p. 20)
Display names programmed into a memory, or scan group.
- 12 SELECT CHANNEL INDICATOR** (p. 23)
Appears when the selected memory channel is set as a select channel.
- 13 BANK NUMBER INDICATOR** (p. 17)
Shows the selected memory bank number.
- 14 BANK INDICATOR** (p. 18)
➤ Appears when the bank limit function is activated.
➤ Flashes during scan when the bank limit function is activated by the auto bank function.
- 15 BANK NAME INDICATOR** (p. 20)
Displays names programmed into a bank.
- 16 AUDIO PEAK FILTER INDICATOR** (p. 15)
“APF” or “APF-N” appears when the audio peak filter function is activated.
- 17 ATTENUATOR INDICATORS**
Appear when the RF attenuator is activated.
- 18 AUTOMATIC GAIN CONTROL INDICATOR** (p. 15)
AGC-F appears when AGC fast is selected; no indication appears when AGC slow is selected.
- 19 RECEIVE INDICATOR**
Appears while receiving.
- 20 FM CENTER INDICATORS** (p. 14)
Appear when the received signal is not tuned to its center frequency.
- 21 NOISE BLANKER INDICATOR** (p. 15)
Appears when the noise blanker circuit is activated.
- 22 AFC INDICATOR** (p. 14)
Appears when the automatic frequency control function is activated in either FM or WFM modes.
- 23 LOCK INDICATOR** (p. 12)
Appears when the main dial or front panel switches are locked.
- 24 SLEEP INDICATOR** (p. 29)
Appears when the sleep timer is set.

■ Mounting installation

◇ Location

Select a location for the receiver that allows adequate air circulation and access to the front and rear panels. Do not place in areas subject to extreme heat, cold, or vibrations, or near TV sets, radios and electromagnetic sources.

Be careful of the internal temperature of the receiver. Installation into a rack or other enclosed area may increase the internal temperature over the useable temperature range. Specifications are not guaranteed under such conditions.

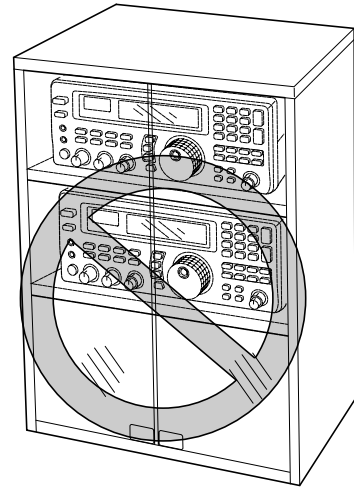

◇ Receiver stand

The base of the IC-R8500 has an adjustable stand for desktop use. Set the stand to one of two angles depending on your operating conditions.

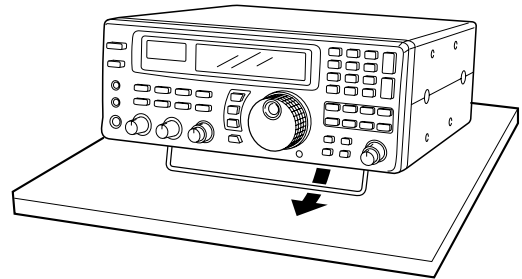
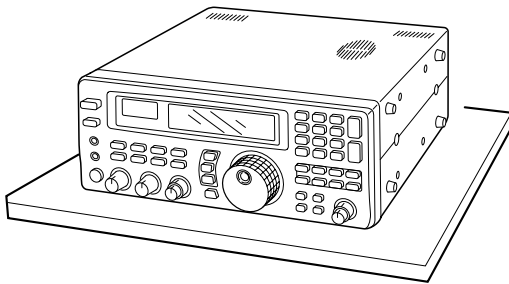

◇ Optional bracket and carrying handle

• Mounting bracket

An optional mounting bracket is available to install the radio under a table, on a wall, in a vehicle, etc.

Select an area to mount the receiver keeping in mind that the weight of the IC-R8500 is approx. 7 kg.

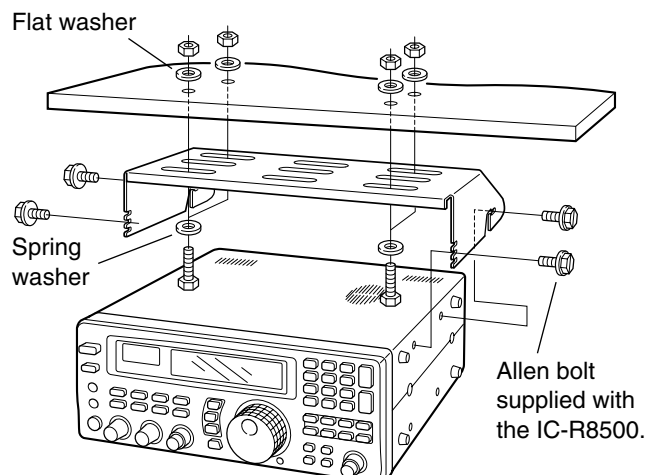

• Carrying handle

An optional handle allows you to easily carry and transport the receiver.

Attach the MB-23 CARRYING HANDLE with the supplied rubber feet as shown.

CAUTION: The screws supplied with the MB-23 cannot be used with the IC-R8500. Use the screws supplied with the IC-R8500 when attaching the MB-23.

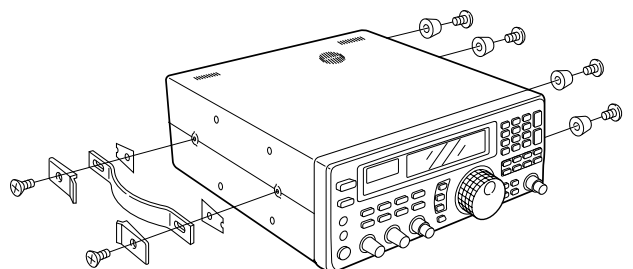

Required connections

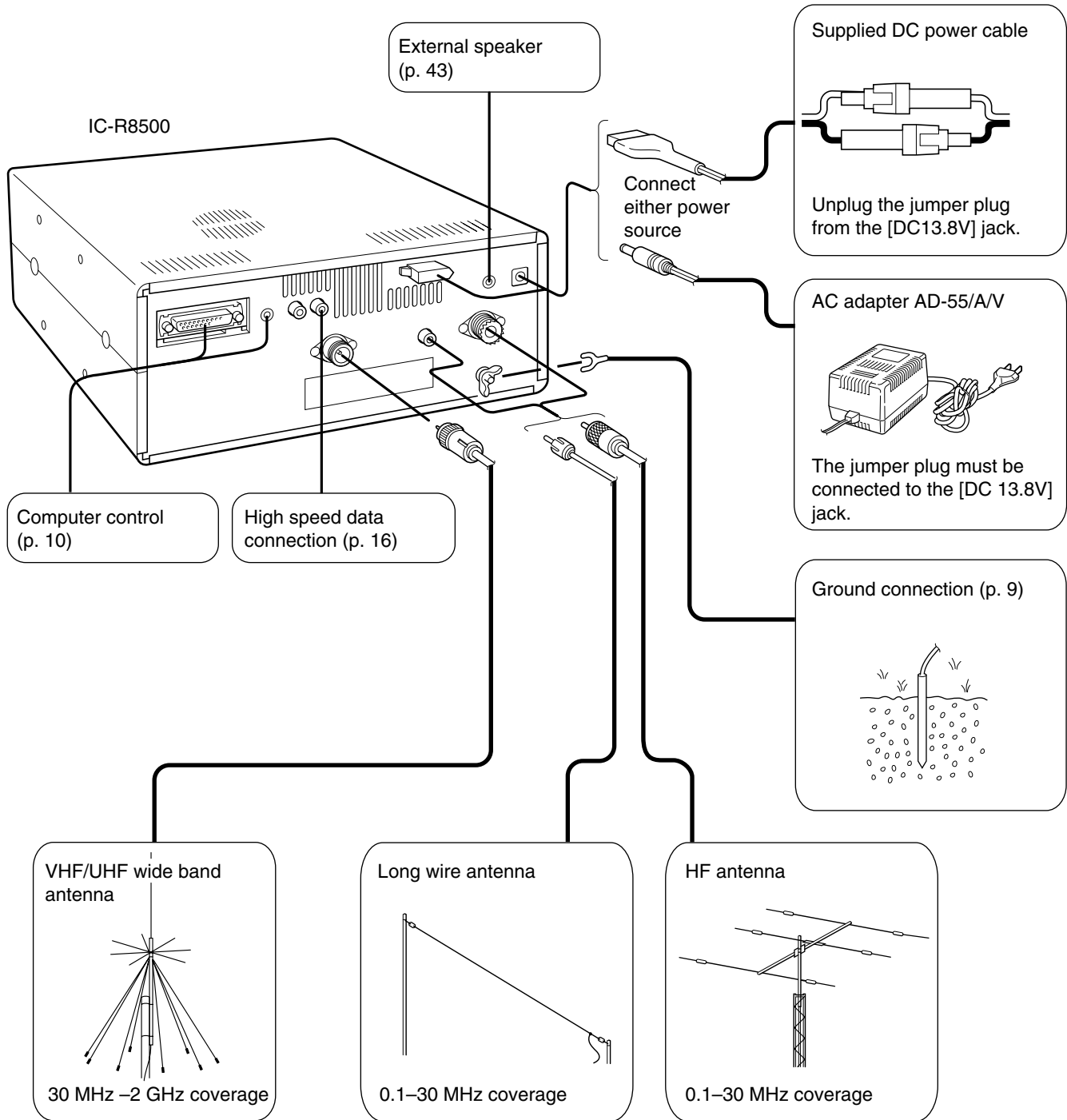

The optional AH-7000 is available for 25 MHz to 1.3 GHz coverage.

Select the active antenna connector in quick set mode (p. 31)

■ Antenna connection

Antennas play a very important role in receiver operation. Connecting a poor quality antenna to the IC-R8500 will result in less than optimum performance.

The IC-R8500 requires at least 2 antennas for full frequency coverage: one for 0.1 to 30 MHz and one for 30 to 2000 MHz.

◇ Using a long wire antenna for HF bands

The IC-R8500 has a 500 Ω phono (RCA) antenna connector for the HF bands. When using a long wire antenna, instead of a 50 Ω matched antenna, use one as long as possible (at least 10 m, 33 ft) and select the active connector as follows:

- ① Push [SLEEP/SET] for 1 sec. to enter quick set mode.
- ② Rotate the [M-CH] selector to select the "HF ANT" item.
- ③ Rotate the main dial to select the antenna connector.
- ④ Push [SLEEP/SET] momentarily to exit quick set mode.

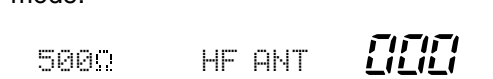

■ Grounding

⚠ WARNING: NEVER use a gas pipe or electrical conduit pipe for grounding.

To prevent accidents involving electricity and interference from transceivers, ground the receiver through the [GND] terminal on the rear panel.

For best results, connect a heavy gauge cable to a water pipe or long, earth-sunk copper rod. Make the distance between the [GND] terminal and ground as short as possible.

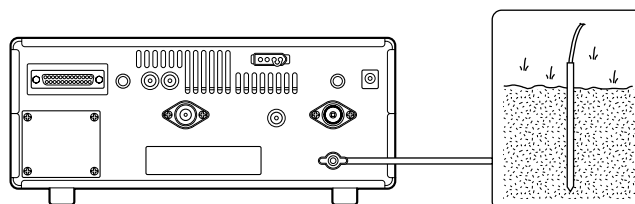

TYPE-N CONNECTOR INSTALLATION EXAMPLE

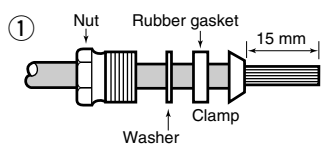

Slide the nut, washer, rubber gasket and clamp over the coaxial cable, then cut the end of the cable evenly.

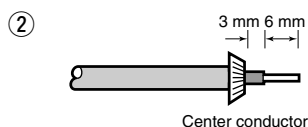

Strip the cable and fold the braid back over the clamp.

(10 mm ≈ 3/8 in)

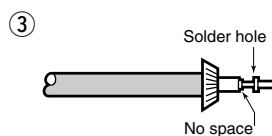

Soft solder the center conductor. Install the center conductor pin and solder it.

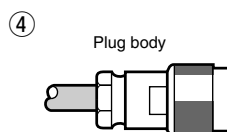

Carefully slide the plug body into place aligning the center conductor pin on the cable. Tighten the nut onto the plug body.

- Be sure the center conductor is the same height as the plug body.

PL-259 CONNECTOR INSTALLATION EXAMPLE

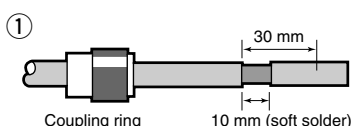

Slide the coupling ring down. Strip the cable jacket and soft solder.

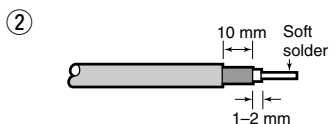

Strip the cable as shown at left. Soft solder the center conductor.

(10 mm ≈ 3/8 in)

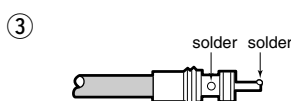

Slide the connector body on and solder it.

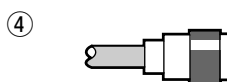

Screw the coupling ring onto the connector body.

■ Tape recorder connections

The [REC OUT] jack has 350 mV rms/4.7 kΩ output for connection to other audio equipment.

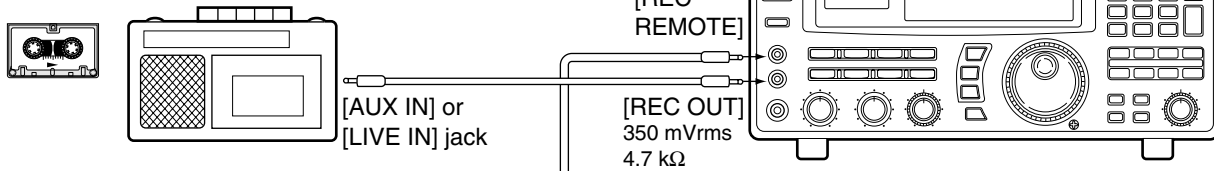

[REC REMOTE] jack: Grounds when a signal is received and squelch opens. If a tape recorder has a control terminal, this jack can be used for recording control. (2 A/DC max.)

✓ Convenient:

When an optional UT-102 VOICE SYNTHESIZER UNIT is installed, detected frequencies during scanning can be recorded. See pgs. 31, 32 for settings.

■ Transceive function

Icom CI-V transceivers or receivers can be connected via the [REMOTE] jack. The frequency and mode become the same* when either radio is changed.

*When a set frequency is out-of-range for one of the connected transceivers or receivers, the connected radio's frequency/mode does not change.

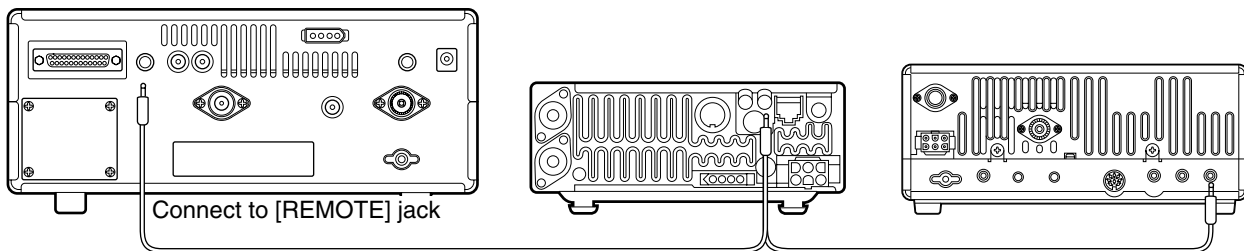

•Be sure the "CI-V TRAN" item is turned ON in initial set mode (p. 32).

■ Connecting to a PC

The IC-R8500 can connect directly to a personal computer providing control of multiple functions such as instant frequency/name programming using appropriate software. See pgs. 35, 36 for the control command table.

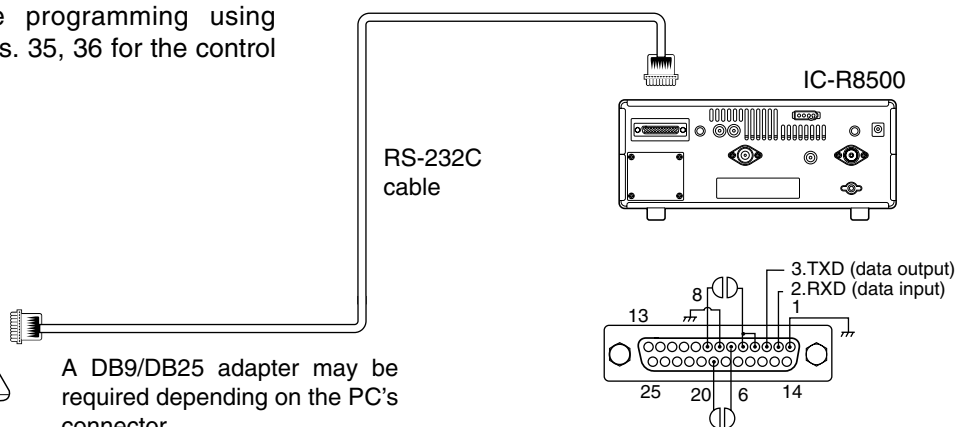
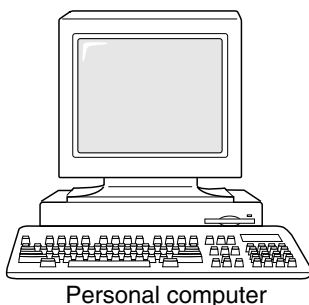

A DB9/DB25 adapter may be required depending on the PC's connector.

■ Data demodulation terminal

See p. 16 for details regarding connection and operation.

Read me first

The IC-R8500 uses memory channels for storage of frequencies (as well as mode, tuning steps, etc.). When turning power OFF or changing memory channels, the previously displayed frequency cannot be recalled unless it has been stored into a memory channel. Therefore, when you want to keep a displayed frequency for later recall, you must program it into a memory channel by pushing [MW] for 1 sec.

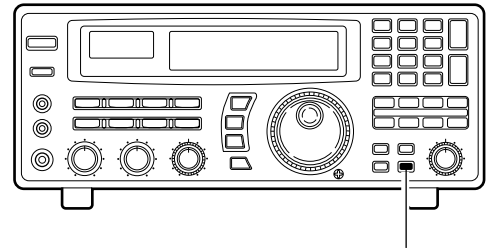

Push [MW] for 1 sec. after tuning.

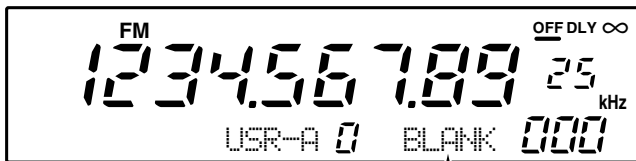

"BLANK" appears in the memory name area until [MW] is pushed for 1 sec.

✓ Convenient:

Use [M-SET] to program a displayed frequency (and its mode, etc.) without overwriting the currently selected memory. See p. 19.

Using the keypad

- ① Push the numeral keys on the keypad to enter the MHz digits for the desired frequency.
 - If a key is mistakenly pushed, push [CE ▶] and start again from the beginning.
 - When entering the same MHz digits as the displayed frequency, this step can be skipped.
- ② Push [•◀].
- ③ Push the numeral keys to enter the frequency digits below 1 MHz.
 - If a key is mistakenly pushed, push [CE ▶] and start again from the beginning.
- ④ Push [ENT] to set the input frequency.
 - When pushing [ENT] after entering the MHz digits, zeros are automatically entered for the kHz digits.

[EXAMPLE]: SETTING THE FREQUENCY USING THE KEYPAD

• To set to 145.00 MHz

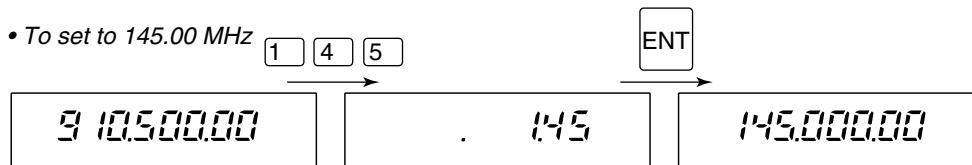

• To set to 1296.040 MHz

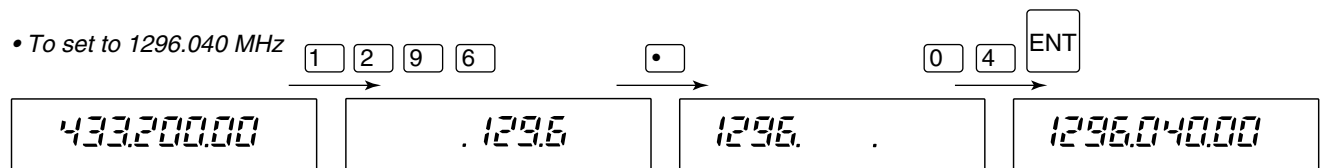

• To set to 850 kHz
(0.85 MHz)

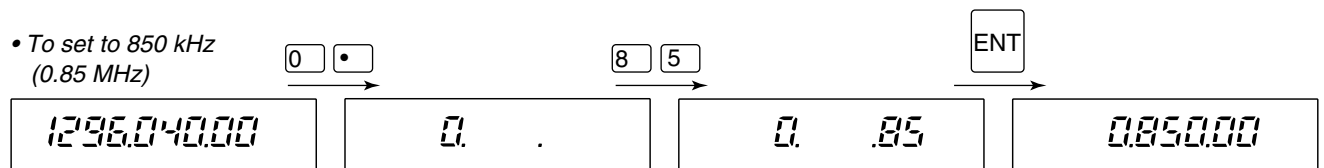

• To change from 1296.040 to 1296.850 MHz

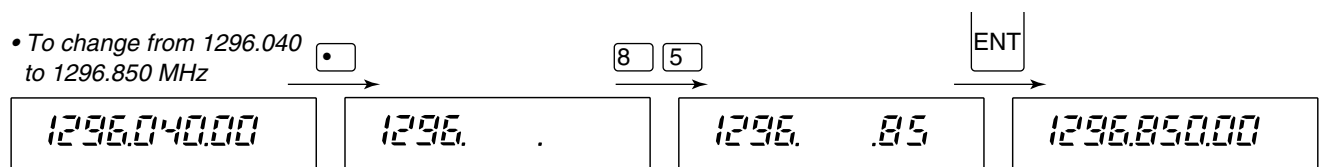

■ Using the main dial

Rotate the main dial to change the frequency.

- The frequency changes in increments determined by the selected tuning step (see below).
- When the lock function is activated (“LOCK” appears) the frequency cannot be changed.

◇ Selecting a tuning step

13 preset tuning steps are available plus 1 programmable tuning step (see below). The preset tuning steps are:

10 50 100 Hz
 1 2.5 5 9 10 12.5 20 25 100 kHz
 1 MHz

Push [TS▲] or [TS▼] to change the selected tuning step.

◇ Setting the programmable tuning step

The programmable tuning step can be set between the range of 0.5–199.5 kHz (in 0.5 kHz steps) for each memory independently.

- ① Push the numeral keys on the keypad that correspond to the tuning step you wish to program.
- ② Push [TS▲] or [TS▼] to set the programmable tuning step to the selected value.
 - The programmable tuning step is automatically selected as the active tuning step.

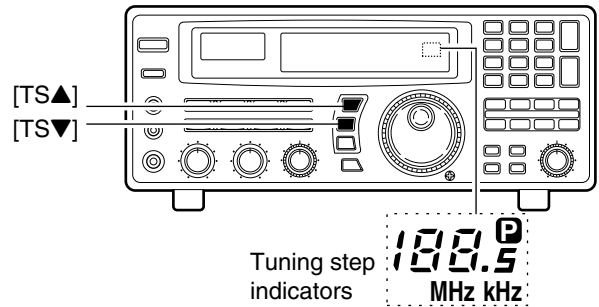

P appears when the programmable tuning step is selected.

MHz or **kHz** appears to indicate the units of the selected tuning step.

[EXAMPLE]: Setting the programmable tuning step to 50 kHz.

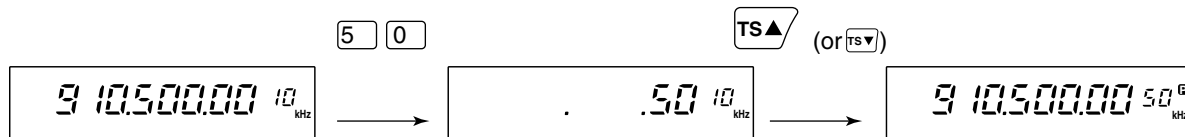

■ Lock function

The lock function electronically locks the indicated frequency from accidentally being changed.

Push [SPCH **LOCK**] for 1 sec. to toggle the lock function ON and OFF.

- “LOCK” appears in the function display while the lock function is activated.



◇ Setting the lock function coverage

The lock function can be set to lock the main dial only or, the main dial and most of the front panel switches.

- ① Push [SLEEP **SET**] for 1 sec. to enter quick set mode.
- ② Rotate the [M-CH] selector to select the “LOCK” indication.
- ③ Rotate the main dial to set the lock function coverage to “DIAL” or “PANEL.”
- ④ Push [SLEEP **SET**] momentarily to exit quick set mode.



Initial settings

Before turning power ON, set controls and switches as indicated below:

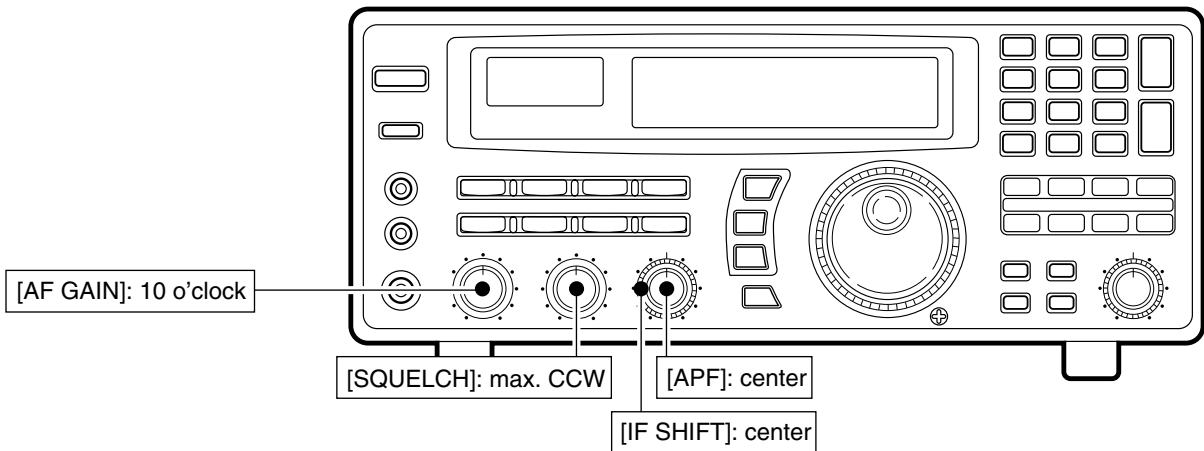



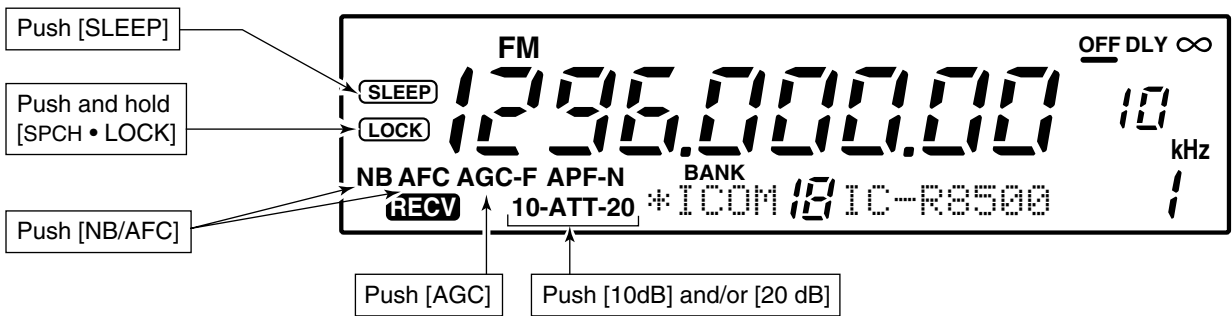

After turning power ON, check the display for indications below and remove as follows:



Mode selection

Push one of the mode keys one or more times to select the desired mode. Consult the table below for basic characteristics of each mode.

The indications in the table appear in the bank name area for 1 sec. after an operating mode is selected.

MODE	BANDWIDTH	INDICATION	DESCRIPTION
FM	normal	12 kHz/-6 dB	 Amateur bands, citizens band, utility communications, marine bands, etc. FM-narrow can only receive narrow FM signals; normal FM can receive both normal and narrow FM signals.
	narrow	5.5 kHz/-6 dB	
AM	medium	5.5 kHz/-6 dB	 Broadcasting, amateur bands, citizens band, air band, etc. AM-wide mode is used for clear audio reception. Signals however, may be received with interference.
	wide	12 kHz/-6 dB	
	narrow	2.2 kHz/-6 dB	
SSB	USB	2.2 kHz/-6 dB	 Shortwave broadcasting, amateur bands, etc. Use USB for normal SSB reception; LSB is not normally used.
	LSB		
CW	normal	2.2 kHz/-6 dB	 Morse code communications. Use this mode to receive radio-tele-type, etc. by shifting the receive frequency.
	narrow (option)	500 Hz/-6 dB	
WFM	150 kHz/-6 dB	 TV broadcasting, FM broadcasting, etc. TV and FM broadcasting cannot be accessed in FM mode because their signals are too wide.	

■ Squelch function

The IC-R8500 has 2 types of squelch, noise squelch and S-meter squelch.

Noise squelch: Only acts on noise; has good sensitivity. It can be adjusted for reception of weak signals. Strong signals exceeding a certain level will always cause the squelch to open.

S-meter squelch: S-meter squelch does not open for weak signals but can be adjusted to open for signals over a wide range of strengths. Once you have selected a threshold point in a range, the IC-R8500 will open for all signals above this point.

To adjust the squelch, rotate [SQUELCH].

- Clockwise rotation closes the squelch (sets the threshold point higher); counterclockwise rotation opens the squelch (for reception of weak signals).

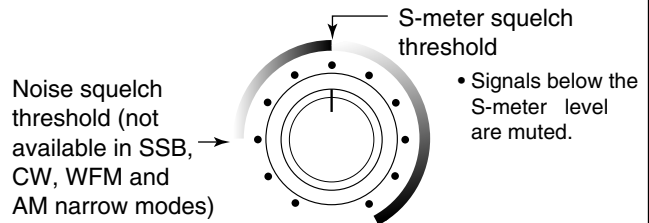

When [SQUELCH] is rotated past center, the S-meter shows the signal strength needed to open the squelch.

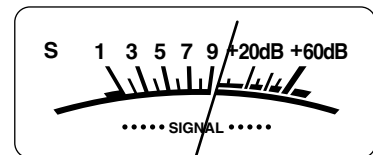

■ Functions for FM

◇ Center indicator

FM signals have a wide bandwidth which makes them easy to receive. However, you may be tuned off-center resulting in audio distortion. The IC-R8500's off-center indicators appear in such cases, making it easy to fine tune to the center of the frequency.



One of these indicators appears when the received signal is off-center.

◇ AFC

AFC stands for automatic frequency control. The AFC circuit automatically compensates the tuning when a receive frequency drifts or goes off frequency.

When one of the off-center indicators appears, the IC-R8500 can adjust the receive frequency automatically—when the AFC function is turned ON and an off-center frequency is received, the frequency in the display automatically changes to reflect the center of the signal.



When one of these indicators appears, the displayed frequency is automatically moved to the center frequency.

■ Functions for SSB/CW

◇ IF shift

The *IF shift* function electronically changes the center of the IF (intermediate frequency) passband frequency to reject interference. The IF shift is not available in FM and AM modes.

- ① Adjust the [SHIFT] control for a minimum interference signal level.
 - The audio tone may be changed while the IF shift is in use.
- ② Set the shift control to its center position when there is no interference.

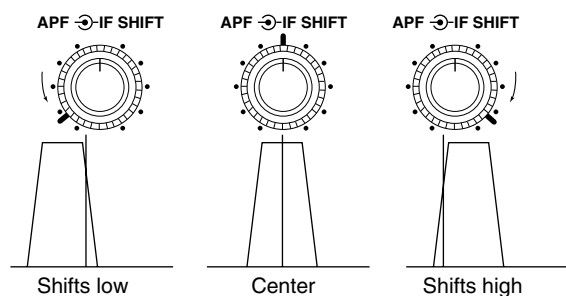

4 RECEIVE FUNCTIONS

◆ Noise blanker

The *noise blanker* reduces pulse-type noise such as that generated by automobile ignition systems. This function is not effective for FM and WFM mode or for non pulse-type noise and wide width pulses.

Push [NB] to toggle the noise blanker ON and OFF.

- "NB" appears when the noise blanker is activated.

NOTE: When a strong signal is received while the noise blanker is ON, the output audio may be distorted. In such cases, the noise blanker should be turned OFF.

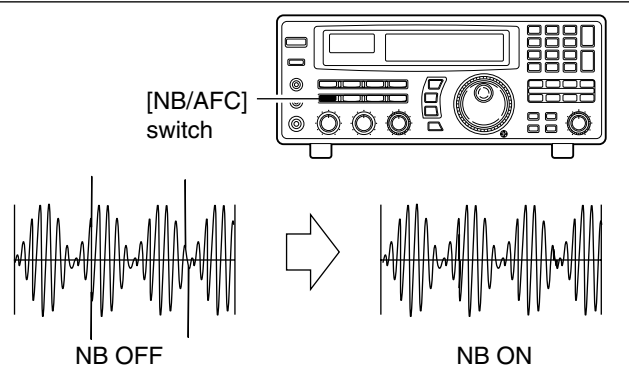

◆ Audio peak filter

The APF (audio peak filter) adjusts the peak frequency of the received audio. The APF can be used for adjusting the audio response. The IC-R8500 has two selectable width filters.* Use the appropriate filter width for optimum receiving.

- ① Push the [APF] switch.
- ② Rotate the [APF] control to adjust the peak frequency.
- ③ To change the filter width*, push [APF] for 1 sec.

*Available for SSB, CW and AM only.

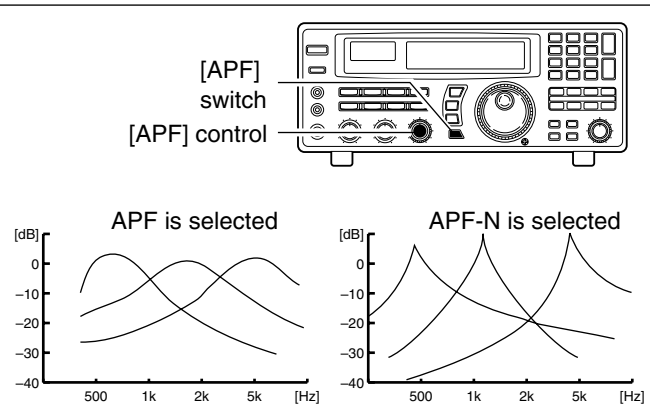

◆ BFO adjustment

BFO stands for beat frequency oscillator. This function is useful in conjunction with the IF shift function. When eliminating interference with the IF shift function, the audio characteristics of the received signal are often changed. Use the BFO adjustment function to adjust the audio quality of the received signal to that desired.

- ① Push [SSB/CW] to select SSB or CW mode.
- ② Push [SSB/CW] for 1 sec. to activate the function.
 - BFO appears.
- ③ Rotate [M-CH] to adjust the BFO.
 - -1.2 kHz to +1.2 kHz are selectable.

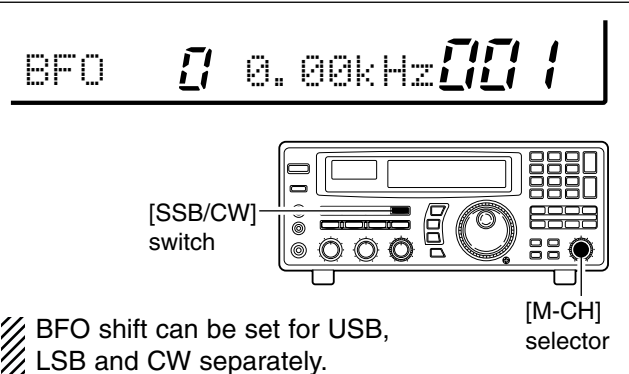

◆ AGC function

AGC stands for automatic gain control. This function controls receiver gain to produce a constant audio output level even when the received signal strength is varied by fading, etc. Use AGC slow for normal phone operation; AGC fast for receiving data and searching for signals. AGC time constant cannot be changed in FM and WFM modes.

Push [AGC] to toggle between AGC fast and slow.

- AGC-F appears when AGC fast is selected; no indicator appears when AGC slow is selected.

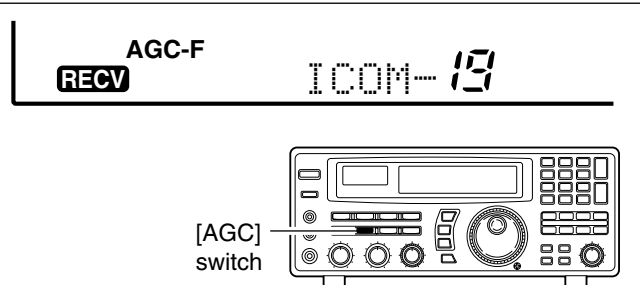

■ Data communications

◇ Connections

•For high speed data (9600 bps) reception in FM mode

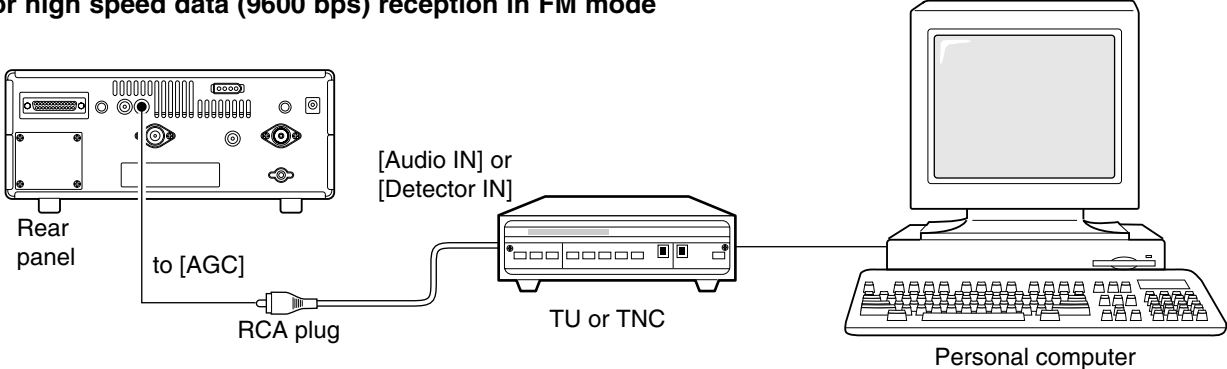

Rear panel

to [AGC]

RCA plug

[Audio IN] or [Detector IN]

TU or TNC

Personal computer

•To use the [AGC] socket for AF output

Change the internal jumper plug as illustrated at right.

- The output is obtained for FM mode only.
- Usable for 9600 bps only.
- Refer to p. 37 for a description of opening the case.

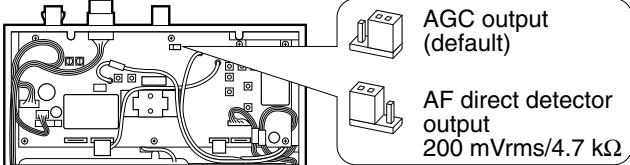

AGC output (default)

AF direct detector output
200 mVrms/4.7 kΩ

•For regular speed data (1200 bps or lower) reception in any mode

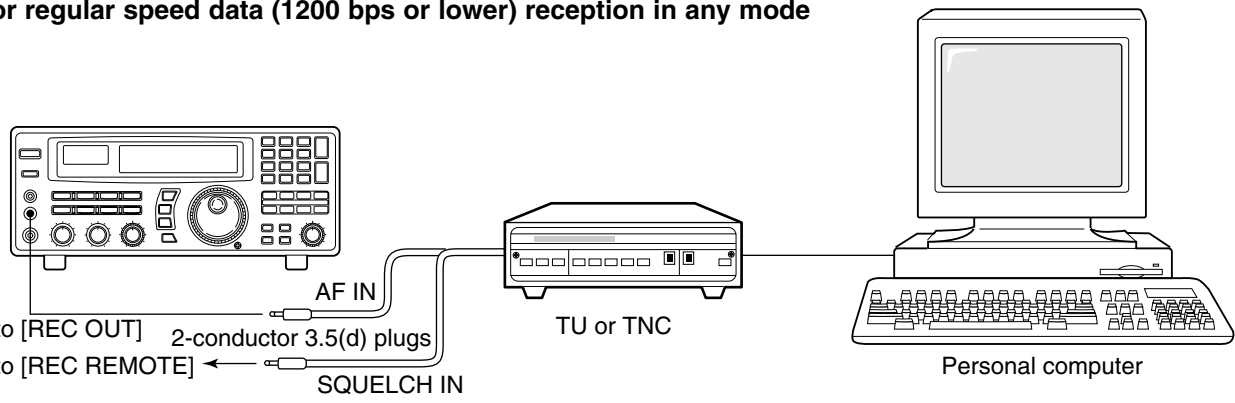

AF IN

to [REC OUT] 2-conductor 3.5(d) plugs

to [REC REMOTE] ←

SQUELCH IN

TU or TNC

Personal computer

◇ Receiving method

- ① Connect a terminal unit as above.
- ② Select FM mode (or USB, CW modes for HF band data communications).
- ③ Set the receiver to the desired frequency as below.
- ④ Set the connected terminal unit to the appropriate settings.
 - Refer to the terminal unit's instructions.

Frequency settings depend on the mode used.

FM mode: [Setting frequency(displayed freq.)]=[Desired freq.]

USB mode: [Setting frequency(displayed freq.)]=[Desired freq.]-[Center of Mark and Space freq.]

CW narrow mode: [Setting frequency(displayed freq.)]=[Desired freq.]-[Center of Mark and Space freq.]+ [600 Hz]

LSB mode (for amateur RTTY): [Setting frequency(displayed freq.)]=[Desired freq.] + [Mark freq.]

General

The IC-R8500 has 1000 regular memory channels, plus 20 programmable scan edge channels and 1 priority channel. 8-digit memory names are programmed into all 1000 channels and 5-digit bank names are programmed into 20 user banks for convenient recall and organisation of frequencies. Moreover, memory channels can store mode information, a tuning step, and ATT (attenuation) information.

NOTE: When memory channels without information (blank channels) are selected, the frequency is not displayed. Only the memory channel number appears.

The table below gives a general overview of the IC-R8500's memory channels.

BANK	INITIAL CONTENTS	USAGE
0-19	40 memories × 20 banks	For normal use. Frequency, mode, tuning step, name and ATT information can be programmed. The number of channels in each bank is user-assignable. Banks cannot be deleted (they must contain at least 1 channel).
AUTO	100 memories	Frequencies detected during auto memory write scan are memorised into this bank in sequence. Mode and tuning step are written at the same time. Note that when the written memories condition is set as CL&START and auto write scan is started, all memories in this bank are cleared.
SKIP	100 memories	Undesired signals such as from beacons, control-coded signals, etc., can be programmed to be skipped during programmed scan and auto memory write scan. When [MW] is pushed for 1 sec. while scan is paused, the displayed frequency is programmed into this bank regardless of the selected bank.
FREE	Blank	For temporary storage when assigning channels to banks. Deleted channels (contents have been cleared) are stored in this bank until being assigned to another bank. This bank does not appear when no channel are assigned.
PROG	20 memories (fixed)	Memorize scan edge frequencies. 10 pairs of scan edges (0P1 to 9P2) are programmable (upper and lower scan edges). Mode and tuning step are automatically equalised to the last programmed channel in a pair.

Bank selection

To select regular channel banks:

Push [M-CH•BANK▲] or [ENT•BANK▼], one or more times to select the desired channel bank.

- The bank indicator shows the selected bank.
- Push and hold [BANK▲] or [BANK▼] to quickly cycle through the channel banks in the order 0 to 19, FREE, AUTO and SKIP.

NOTE: The FREE bank is initially blank and therefore cannot be selected. In order to select it at least 1 channel must be programmed into the FREE bank. See p. 21.

✓ Convenient: Bank names

The default names of "USR-A" to "USR-T" can be set to your own preference. Refer to p. 20 for programming.

To select the programmed scan edge:

Push [PROG] for 1 sec.

- PROG and channel number (0P1 to 9P2) appear.

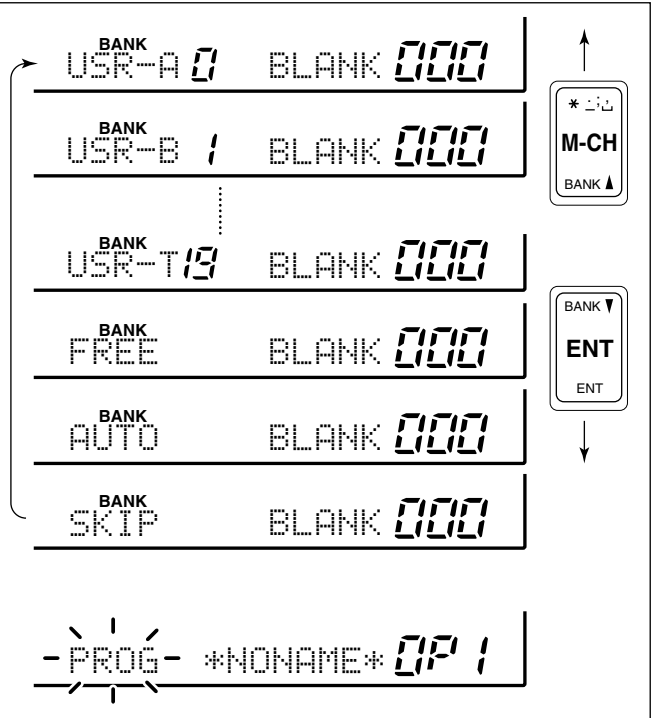

■ Channel selection

◇ Using the [M-CH] selector

- ① Select the desired bank using [M-CH•BANK▲] or [ENT•BANK▼].
- ② Rotate the [M-CH] selector to select the desired channel.

•Bank limit function

While rotating the [M-CH] selector, memory channels can be selected from within the current bank only; or from any bank.

Push [BANK] to toggle the bank limit function ON and OFF.

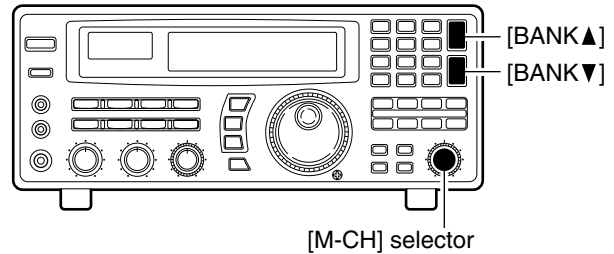

[M-CH] selector

✓ Convenient: Automatic bank limit

When starting memory scan, the bank limit function is activated automatically. This automatic selection can be deactivated. See p. 26.

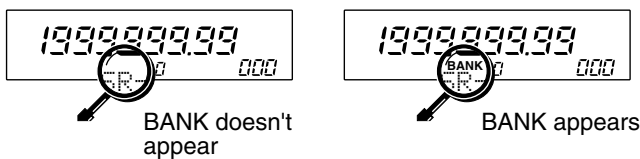

•Bank limit OFF

All memory channels can be selected via the [M-CH] selector. [BANK▲]/[BANK▼] can be used.

•Bank limit ON

Only memory channels in the current bank can be selected. Banks can be selected with the [BANK▲]/[BANK▼] keys only.

◇ Using the keypad

Memory channels in the current bank can only be selected via the keypad.

- ① Select the desired bank using [M-CH•BANK▲] or [ENT•BANK▼].
 - ② Push keys corresponding to the desired channel.
 - ③ Push the [M-CH] key to set the selected memory channel.
- Input for memory channels not available is cancelled.

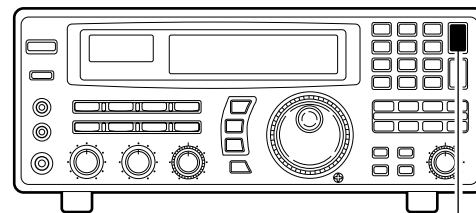

[M-CH] key

[EXAMPLE]: Selecting channel 39 from within the currently selected bank

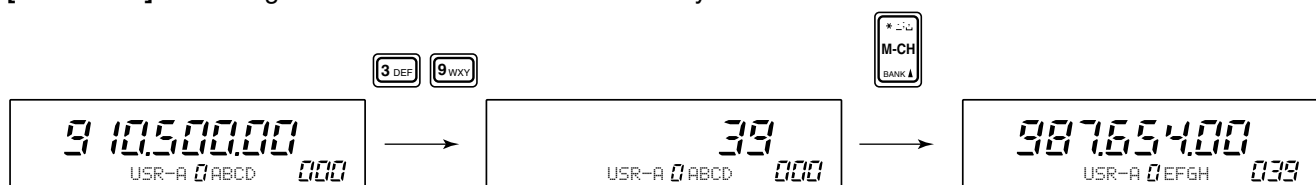

[EXAMPLE]: Selecting channel 12 from a different bank (bank 3)



■ Programming

This is the method most often used to program memory channels.

- ① Select the desired memory channel.
- ② Set the desired frequency.
 - When the memory channel already contains information, change the frequency using the main dial or the keypad.
 - When the memory channel is blank, use keypad entry only to set the frequency.
- ③ Set operating mode (p. 13) and tuning steps (p. 12).
- ④ Push and hold [MW] until the receiver emits 3 beeps.
 - The information is stored in the memory channel.

NOTE: When changing the memory channel before pushing [MW], the set frequency (and mode/tuning steps) is erased.

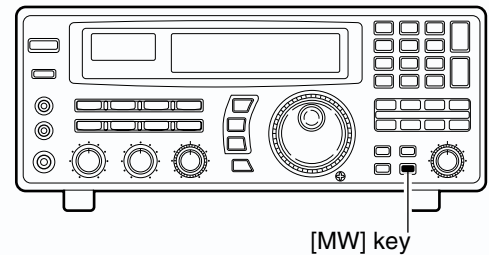

■ Copy and paste (memory editing)

When the frequency (and mode/tuning steps) is set for a channel; or, when you want to change a frequency using the contents of another memory channel, the copy/paste function is helpful to keep (or confirm) the previously programmed contents.

- ① Push [M-SET] to temporarily store the displayed frequency, mode, etc.
 - "M" appears.
 - Only 1 channel can be stored in the temporary space.
- ② Select the memory channel you wish to program the frequency into.
- ③ Push [M-SET] again to paste the stored contents.
 - "M" disappears.

NOTE: Remember that pushing [MW] is always necessary to program contents into a memory channel. Pasted contents will be cleared if the [MW] key is not pushed for 1 sec.

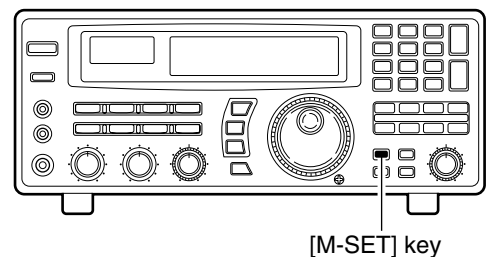

■ Clearing

Information programmed into a memory channel can be cleared (erased).

- ① Select the memory channel to be cleared.
- ② Push and hold [M-CL] until the receiver emits 3 beeps.

✓ **Convenient:** Bank assign function

Using the bank assign function, memory channels can be removed (along with their programmed contents) from a particular memory bank and placed temporarily in the 'free' bank. See p. 21.

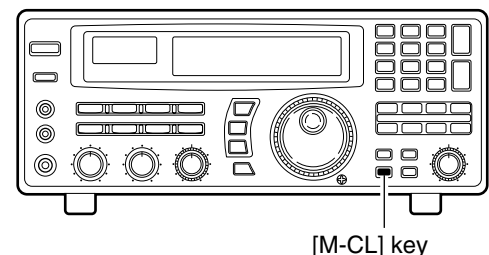

■ Channel/bank names

Channel names of up to 8 characters and bank names of up to 5 characters can be programmed for convenience. Programmed names can be easily copied to other channels using the copy/paste function.

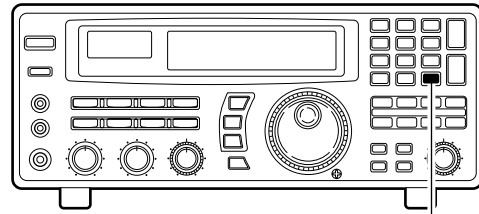

[CE▶•NAME] key

◇ Channel name programming

- ① Select the desired memory channel.
- ② Set the frequency (and mode/tuning steps), then push and hold the [MW] key.
 - When no data is programmed, "BLANK" appears and memory names cannot be programmed.
- ③ Push [CE▶•NAME].
 - A cursor appears at the first character space of the name area.
- ④ Enter the desired name via the keypad.
 - Push the appropriate keys to input the desired characters.
 - To erase a character, overwrite with a 'space' using the [M-CH• *] key.
 - To move the cursor forwards or backwards, use the [◀] or [▶] key.
- ⑤ Push [ENT] to input the set name.

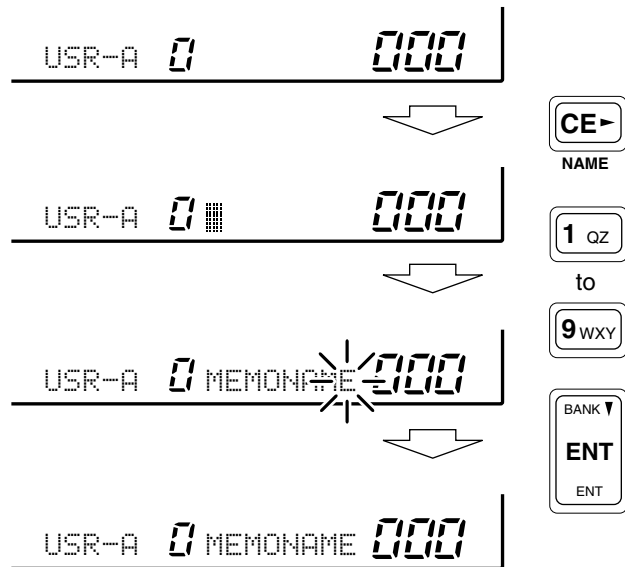

◇ Bank name programming

- ① Select the desired bank using [M-CH•BANK▲] or [ENT•BANK▼].
- ② Push [CE▶•NAME].
 - A cursor appears at the first character space of the name area.
 - When no data is programmed, ("BLANK" appears) the cursor does not appear. Program a frequency or change the channel in such cases.
- ③ Push [▶] to move the cursor to the bank name area.
- ④ Enter the desired name via the keypad.
 - Use the same method as for channel names (see above).
- ⑤ Push [ENT] to input the set name.

/// **NOTE:** When using [CE▶] on the last digit of the bank name, the current name is cleared and the previous one is substituted. DO NOT forget to push [ENT] after the bank name is set.

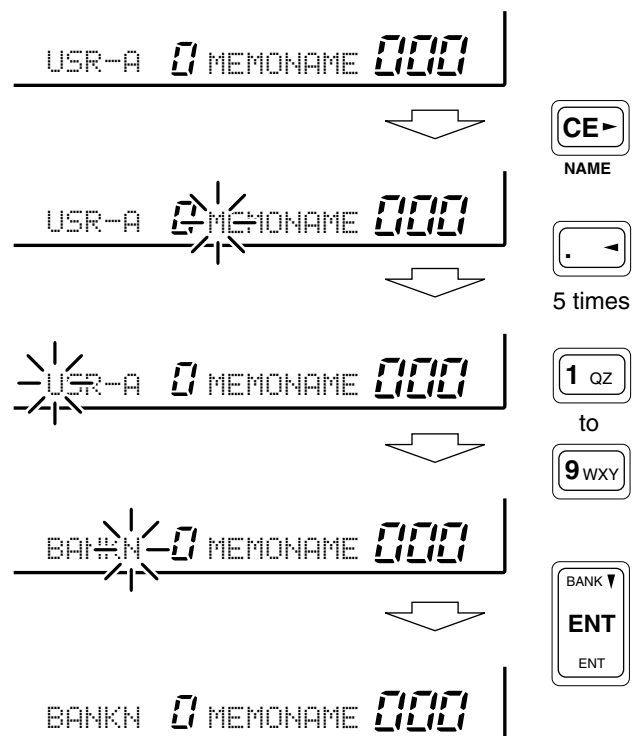

■ Assigning channel numbers

The IC-R8500 has 20 banks in which memory channels can be programmed and arranged. By default, each bank contains 40 memory channels, however, channels can be deleted from or added (inserted) to banks to suit your preferences and operating style.

Deleted channels are stored temporarily in the "FREE" bank.

NOTE: When shipped from the factory or after resetting the receiver's CPU, the "FREE" bank has no memory channels and cannot be selected.

To rearrange bank channel assignments:

- ① Delete memory channels from banks that have more memory channels than you need.
 - Deleted channels are assigned to the 'free' bank automatically.
- ② Add (or insert) memory channels to banks in which you want to add channels.
 - Channels added to a bank are deleted from the 'free' bank.

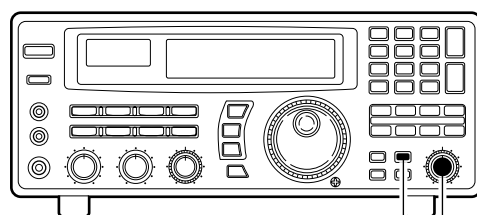

[BANK] switch

[M-CH] control

◇ Deleting memory channels

- ① Select the bank and memory channel you wish to delete.
- ② Push [BANK] for 1 sec.
 - One of "INS. 1CH," "DEL. 1CH," "ADD. 10CH," or "ADD. 1CH," appears and flashes.
 - Push [BANK] momentarily to exit the condition and return to the previous display, if desired.
- ③ Rotate [M-CH] until "DEL. 1CH" appears in the display.
- ④ Push [BANK] for 1 sec. to delete the selected channel.
 - The memory channel (but not its contents) is moved to the "FREE" bank.

Memory channels can only be deleted one at a time to prevent accidental deletion of multiple channels; when you want to delete more than one channel from a bank, repeat the above steps as many times as necessary.

NOTE1: Deleted channels are moved to the 'free' bank, however, the programmed contents are erased.

NOTE2: The number of banks cannot be decreased. This means that if there is only one channel in a bank, it cannot be moved to the 'free' bank.

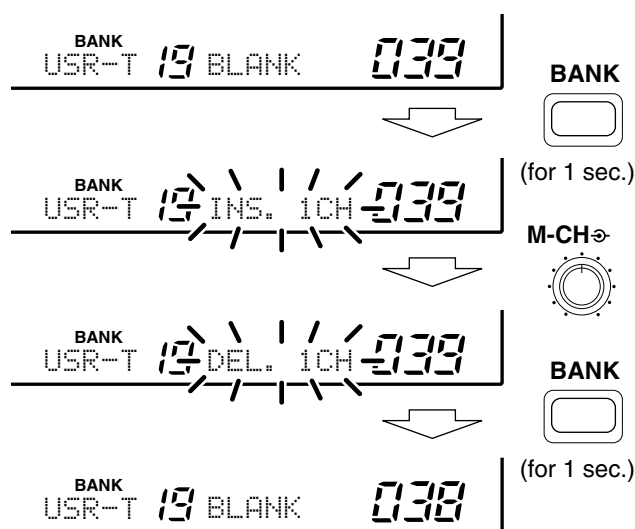

The number of channels in this bank is decreased.

◇ Adding/inserting memory channels

- ① Select the bank you wish to add memory channel(s) to.
- ② Push [BANK] for 1 sec.
 - One of "INS. 1CH," "DEL. 1CH," "ADD. 10CH," or "ADD. 1CH," appears and flashes.
 - Push [BANK] momentarily to exit the condition and return to the previous display, if desired.
- ③ Rotate [M-CH] to select the following:

INDICATION	DESCRIPTION
INS. 1CH	1 channel will be inserted 'in front' of the selected channel. • Programmed contents after the inserted channel are shifted accordingly.
ADD. 1CH	1 channel will be added 'at the end' of the selected bank.
ADD. 10CH	10 channels will be added 'at the end' of the selected bank.

- ④ Push [BANK] for 1 sec. to perform the selected operation.
 - The memory channel(s) are deleted from the "FREE" bank and added/inserted to the selected bank.
 - Memory channels cannot be added/inserted into a memory bank when the "FREE" bank is empty.

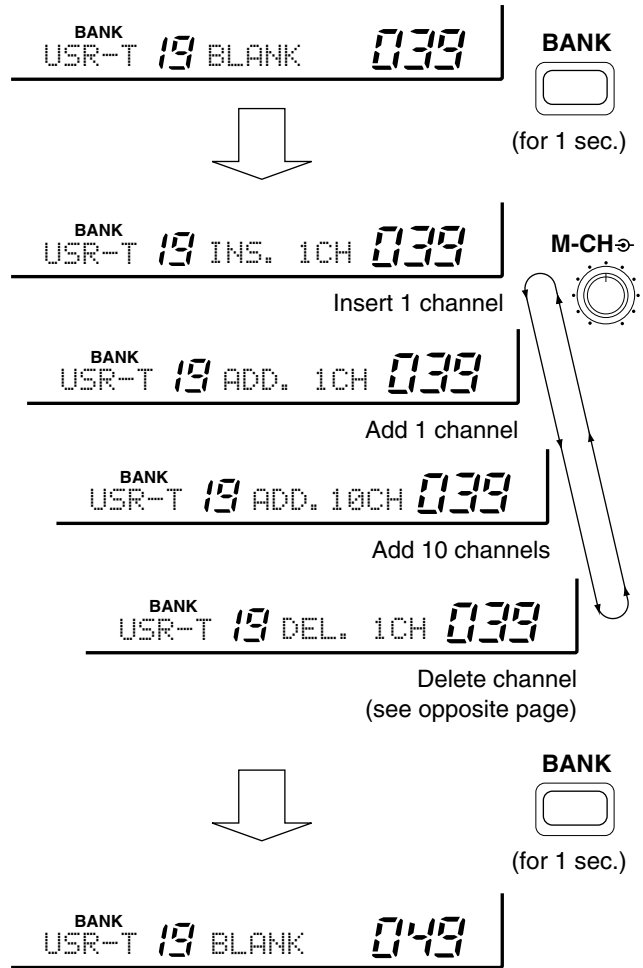

■ Operation

◇ Memory scan

All memory channels (except skip channels) in the selected bank are scanned at up to 40 ch/sec.

- ① Push [M-CH•BANK▲] or [ENT•BANK▼] to select the desired bank.
 - Direct selection is also available as below.
- ② Set the [SQUELCH] control to the threshold point.
- ③ Push [MEMO] to start the scan.
 - “MEMO” appears in the bank name area.
- ④ Push [MEMO] again to stop the scan.

✓ Convenient:

Direct bank selection—Memory scan can be started in a specific bank without using [BANK▲/▼]:

⇒ Enter one or two digits for the bank number, then push [MEMO].

Bank selection during memory scan—The selected bank can be changed without stopping the scan:

⇒ Enter one or two digits for the bank number, then push [ENT].

Bank limit and skip scan release—When starting memory scan, the bank limit and channel skip functions are activated automatically. Refer to p. 26.

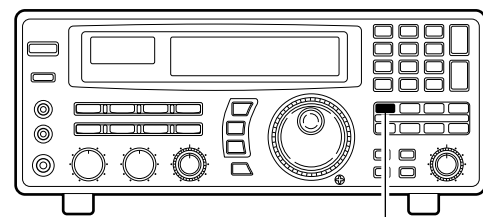
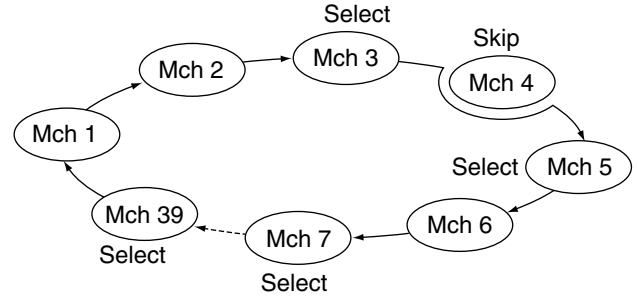

Push [MEMO]

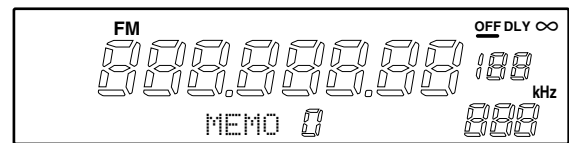

MEMO appears

◇ Memory select scan

Memory select scan allows you to increase scan efficiency by searching for specified channels only, thereby increasing the rate at which the scan cycles through the memory channels. Set high priority channels as 'select' channels (memory select scan searches for signals on these channels) while leaving out lower priority channels.

Preparation—specifying select channels:

Select the channel you want to specify as a 'select' channel, then push [SEL] for 1 sec.

Start/stop:

- ① Select the desired bank using [M-CH•BANK▲] or [ENT•BANK▼].
- ② Set the squelch control to the threshold point.
- ③ Push [SEL] momentarily to start scan.
 - “SEL” appears in the bank name area.
- ④ Push [SEL] again to stop the scan.

NOTE: Memory select scan does not start unless 2 or more channels in the bank are specified as select channels.

✓ Convenient:

The same convenient functions are available as described above.

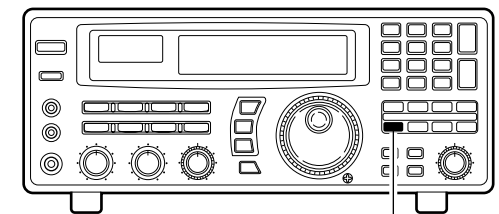
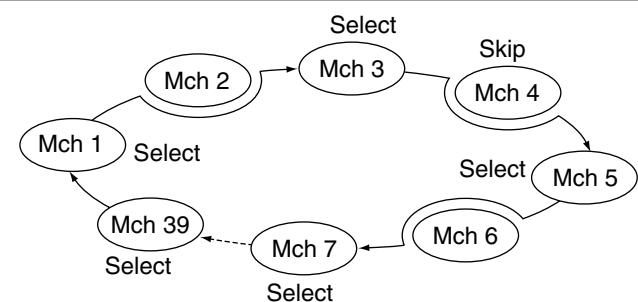

Push [SEL]

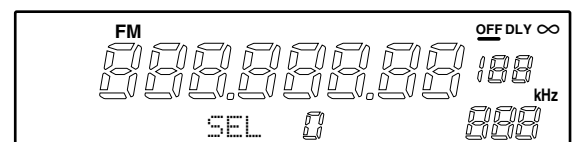

SEL appears

◇ Programmed scan

Programmed scan (and auto memory write scan) searches for signals within a specified frequency range, using the selected tuning step increments. The result is like an 'automatic' rotating of the main dial.

Preparation—setting the scan range:

Push and hold [PROG] to enter the 'prog' bank, then input the desired edge frequencies, mode and tuning steps. Refer to p. 27 for details.

Start/stop:

- ① Set the [SQUELCH] control to the threshold point.
- ② Push [PROG] to start the scan.
 - "PROG" (and scan range number) appears in the bank name area.
- ③ Push [PROG] again to stop the scan.

✓ Convenient:

Direct range selection—The desired programmed scan range can be selected using the keypad.

⇨ Push a numeral key before or after pushing the [PROG] key.

Skip scan release—Programmed scan skips all frequencies specified as skip channels in all 1000 channels.

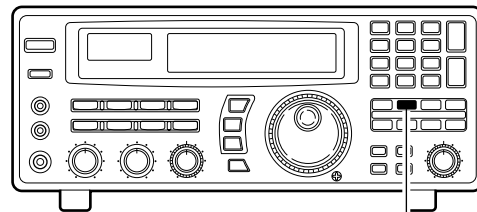
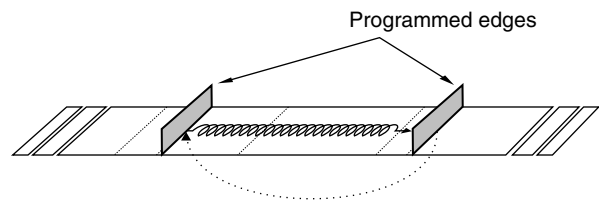

Push [PROG]

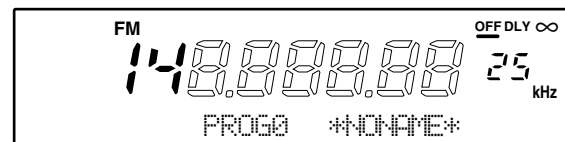

PROG appears

◇ Auto memory write scan

Auto memory write scan operates in the same way as programmed scan. However, when a signal is received, the received frequency is automatically written into a memory channel in the auto write bank.

Preparation—written memories condition:

Push and hold [AUTO] to enter the written memory setting condition, then rotate the main dial to select the condition.

AUTO START : Previously written memories in the 'Auto' bank are saved, then frequencies are written into the next available channels.

AUTO CL&START : Previously written memories in the 'Auto' bank are cleared, then frequencies are written into channels, starting from channel 0.

Start/stop:

- ① Set the [SQUELCH] control to the threshold point.
- ② Push [AUTO] momentarily or for 1 sec. to start the scan.
 - **CAUTION:** Be sure the written memories condition is set as desired, otherwise previously written memories are cleared.
 - "AUTO" (and scan range number) appear in the bank name area.
- ③ Push [AUTO] again to stop the scan.

✓ Convenient:

The same convenient functions are available as described above.

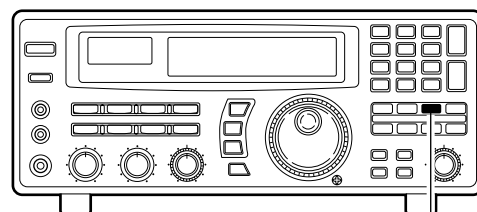
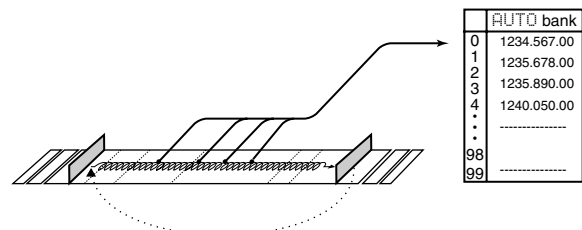

Push [AUTO]

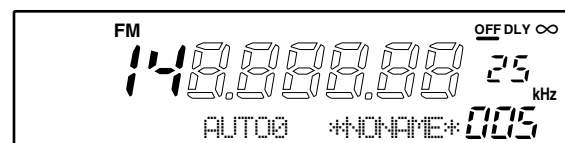

AUTO appears

◆ Priority scan

Priority scan monitors a specified frequency (the priority channel) once every 1–16 sec. (programmable) during any operation, such as receiving, scanning other channels, etc.

Preparation—priority channel programming:

- ① Push [PRIO] for 1 sec.
 - “*SET*” appears in the bank name area, then changes to a flashing “PRIO.”
 - Using this method, the priority channel can be called up at any time with one push.
- ② Set the desired frequency, mode and memory name.
- ③ Push [MW] for 1 sec. to write the contents into the priority channel.
- ④ Push [PRIO] again to return to the previous channel.

Start/stop:

Push [PRIO] to start/stop the scan.

- Priority scan can be used in combination with other scan types: start another scan type during priority scan; or, push [PRIO] while operating another scan.

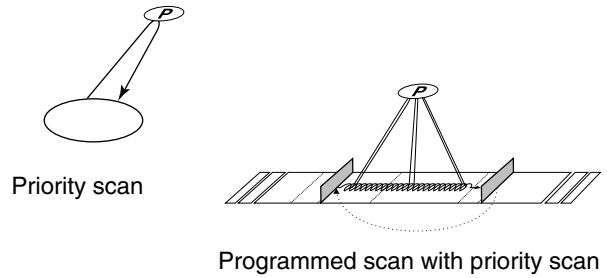

■ Mode select function

To operate memory scan or memory select scan in a specific mode (ignoring other modes), the mode select function is available.

- ① Push [MEMO] or [SEL] to start memory scan or memory select scan, respectively.
- ② Select the desired mode to operate the scan in via the mode switches.
 - The mode select function is applied to memory or memory select scan.
- ③ Push [MEMO] or [SEL] again to stop the scan.

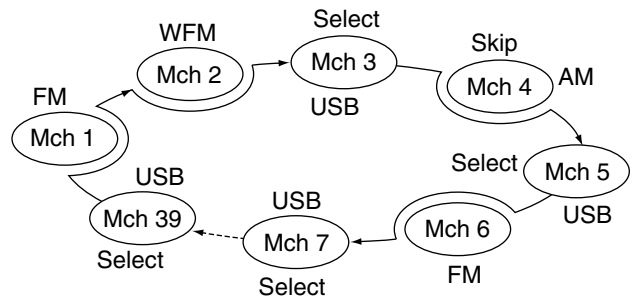

■ Specifying skip channel and frequency

•*Specifying skip channels*

- ① Select the memory channel to be specified as a skip channel.
- ② Push [SKIP] for 1 sec. to toggle the setting ON and OFF.
 - SKIP-CH appears when ‘skip’ is set.



The channel is specified as a ‘skip’ channel.

•*Programming skip frequencies (for programmed scan)*

- ① Start programmed scan.
- ② When the scan pauses on an undesired signal, push [MW] for 1 sec.
 - The frequency is memorised into the skip bank as a skip frequency.
 - The specified channel is skipped during memory and memory select scans.
 - The programmed frequency is skipped during programmed and auto memory write scans.



Push [MW] for 1 sec. while programmed scan pauses.

■ Automatic bank limit/skip functions

When starting a scan, the following functions are automatically turned ON by default; and the [SKIP] and [BANK] switches are deactivated during scan.

- *The bank limit function* (for memory scan and select memory scan)—The memory scan operates within the selected bank only.

- *The skip function* (for any scan except priority scan)—memory channels specified as skip channels are not checked during memory scan and select memory scan; the frequencies which are programmed into memory channels as skip channels (not only in the skip bank but any memory channels) during programmed scan and auto memory write scan.

• Turning OFF the automatic function

- ① Push [MEMO] for 1 sec.
 - A display as at right appears.
- ② Rotate the [M-CH] selector to select the item, SKIP or BANK.
- ③ Rotate the main dial to select the function AUTO or MANUAL.
- ④ Push [MEMO] to return to the previous display.

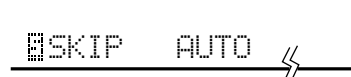

The skip function is turned ON automatically at scan start. [SKIP] does not function during scan.

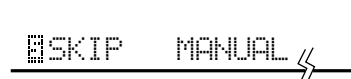

The scan skip function is turned ON and OFF by [SKIP] regardless of scan start.

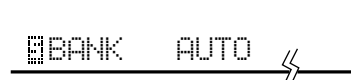

The bank limit function is turned ON automatically at scan start. [BANK] does not function during scan.



The bank limit function is turned ON and OFF by [BANK] regardless of scan start.

■ Voice scan control function

This function is useful when you don't want unmodulated signals pausing or cancelling a scan. When activated, the receiver checks received signals for voice components.

If a receiver signal includes voice components, and the tone of the voice components changes within 1 sec., scan pauses (or stops). If the received signal includes no voice components or the tone of the voice components does not change within 1 sec., scan resumes.

To toggle the function ON and OFF, push [VSC].

- "VSC" appears while it is activated.

- The VSC function activates for any scan.
- The VSC function resumes the scan on unmodulated signals even when the resume condition is set to "OFF" or "∞".

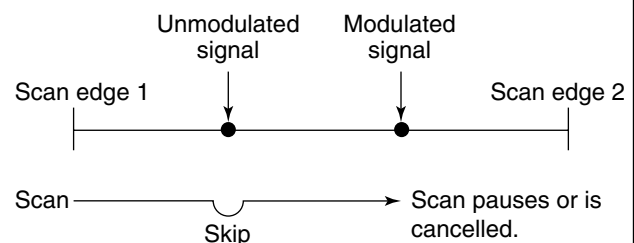

■ Programming scan edge frequencies

A set of scan edge frequencies must be programmed before starting the programmed or auto memory write scans. 10 pairs of scan edges are available: 0P1 to 9P2.

- ① Push [PROG] for 1 sec.
 - “*SET*” appears in the bank name area, then changes to a flashing “PROG.”
- ② Rotate the [M-CH] selector to select the lower scan edge in a pair e.g. 0P1.
 - The keypad can also be used for selection.
- ③ Set the frequency, mode, tuning step and memory name then push [MW] for 1 sec. to program one of the scan edges.
- ④ Rotate the [M-CH] selector to select the other edge in the pair e.g. 0P2.
- ⑤ Set the frequency then push [MW] for 1 sec. to program.
 - Mode, tuning step and name are common to both scan edges.
- ⑥ Push [PROG] momentarily to return to the previous channel; or repeat ② to ⑥ for other scan edges.

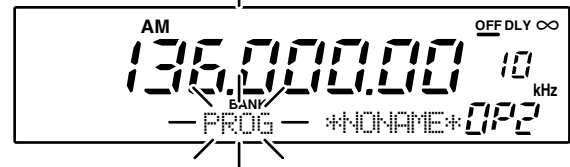
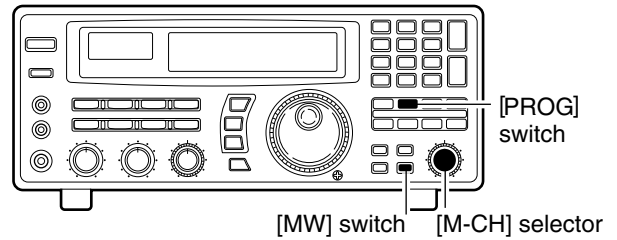

■ Scan speed/delay functions

◇ Scan resume condition

Scan pauses when finding a signal, and then resumes or is cancelled depending on the selected scan resume condition. There are 3 resume conditions.

Push [DLY] one or more times to select a resume condition.

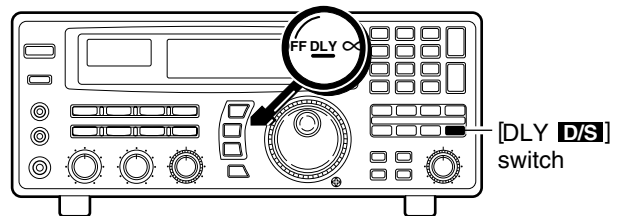

• Scan resume OFF

Scan pauses until signal disappears, then resumes 3 sec. after that.

OFF DLY ∞

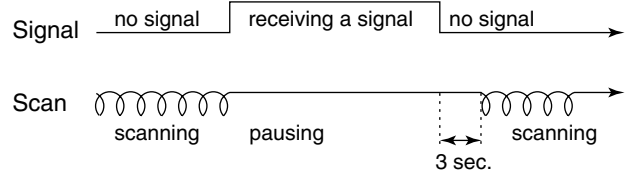

• Scan resume ON with adjusted delay period

Scan pauses for the adjusted delay period after receiving a signal, then resumes. When the received signal disappears, scan resumes approx. 3 sec. after that.

OFF DLY ∞

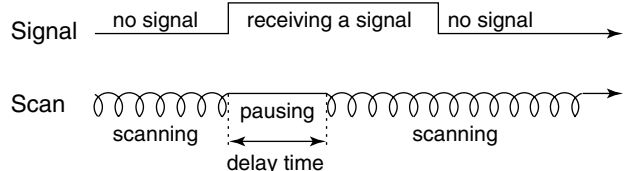

• Scan cancel

Scan is cancelled when a signal is found during scan.

OFF DLY ∞

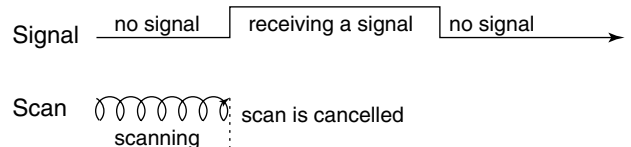

◆ Assigning a function to the [DELAY/SPEED] control

The function of the [DELAY/SPEED] control is selectable, as shown below, to suit your operating style.

- ① Push [DLY **DS**] for 1 sec. to enter the setting condition.
- ② Rotate the main dial to select the function for the [DELAY/SPEED] control.
- ③ When the scan speed is assigned to the [DELAY/SPEED] control, the scan delay time is determined while "UR:SPD DLY: 3S" appears.
 - Rotate the [M-CH] selector to set the delay time.
- ④ Push [DLY **DS**] to return to the previous display.

Scan speed is assigned to the [DELAY/SPEED] control

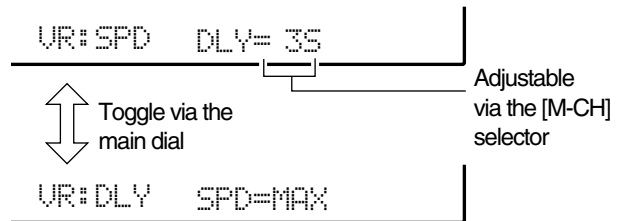

Scan delay is assigned to the [DELAY/SPEED] control

◆ Scan speed

When scan speed is assigned to the [DELAY/SPEED] control (see above), the scan speed can be instantly updated during scan operation.

The name area shows as at right for 1 sec. after rotating the control.

When scan delay time is assigned to the [DELAY/SPEED] control, the scan speed is fixed at the maximum of 40 ch/sec.

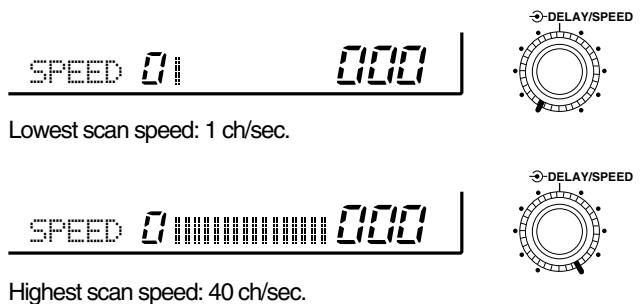

◆ Scan delay

The [DELAY/SPEED] control adjusts the scan delay period (scan resume period) when:

- The scan delay function is assigned to the [DELAY/SPEED] control (see above).
- "DLY" is selected for the scan resume condition with the [DLY **DS**] switch.

When scan speed is assigned to the [DELAY/SPEED] control, the scan delay is determined by the set value of 3 to 18 sec.

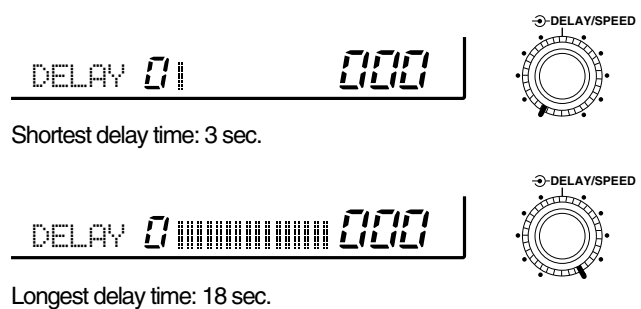

The IC-R8500 has a sleep timer function to automatically turn the power OFF after a specified period.

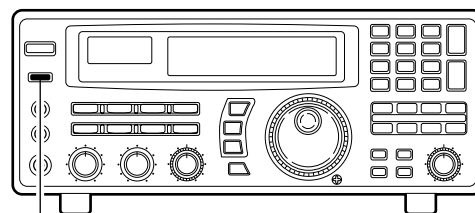

[SLEEP/SET] switch

◇ Operation

① Push [SLEEP/SET] momentarily, several times, to activate the sleep timer and set the power OFF period.

- When the sleep timer is activated, "SLEEP" appears in the display.
- 5 settings are available: 120, 90, 60, 30 min. and sleep OFF.

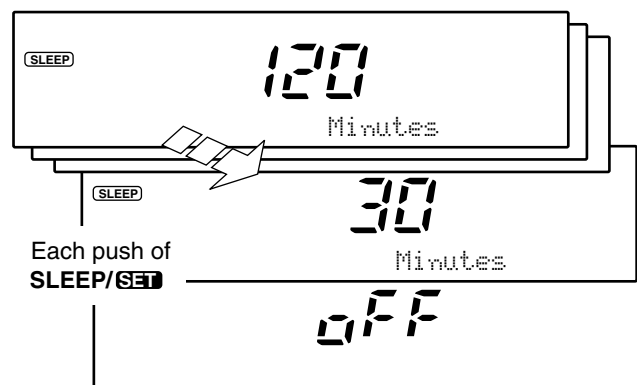

Each push of
SLEEP/SET



after 2 sec.

② 2 sec. after performing step ① above, the receiver returns to the previous display.



Previous display

Push SLEEP/SET once

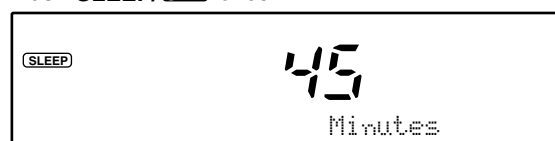

Set time

④ To turn ON the receiver after the sleep timer has turned power OFF, push [POWER] OFF then ON again.

- The sleep timer is cancelled.

■ General

Set mode is used for programming infrequently changed values or conditions of functions. The IC-R8500 has 2 separate set modes: *quick set mode* and *initial set mode*.

◇ Selecting quick set mode

- ① Push [SLEEP/SET] for 1 sec.
 - Quick set mode is selected and one of its items appears.
- ② Rotate the [M-CH] control to select the desired item.
- ③ Rotate the main dial to set the values or conditions for the selected item.
- ④ Repeat steps ② and ③ to set other items.
- ⑤ To exit quick set mode, push [SLEEP/SET] again.
 - Pushing any other switch will also exit quick set mode.

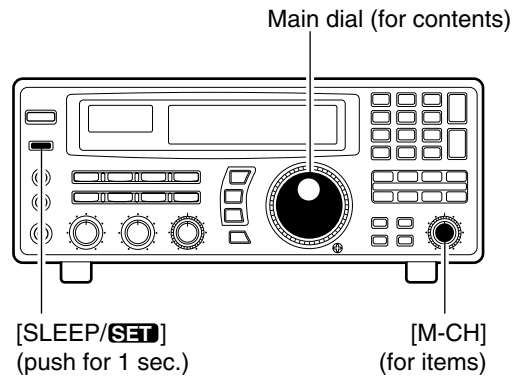

[DISPLAY EXAMPLE: QUICK SET MODE]

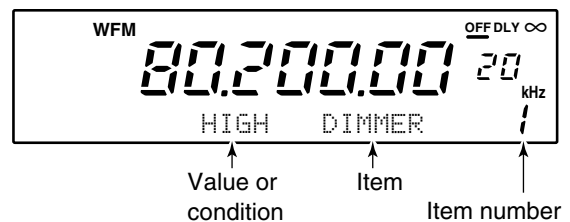

◇ Selecting initial set mode

- ① Push [POWER] to turn power OFF.
- ② While pushing [SLEEP/SET] push [POWER] to turn power ON.
 - Initial set mode is selected and one of its items appears.
- ③ Rotate the [M-CH] control to select the desired item.
- ④ Rotate the main dial to set the values or conditions for the selected item.
- ⑤ Repeat steps ③ and ④ to set other items.
- ⑥ To exit initial set mode, push [POWER] to turn power OFF.
- ⑦ Push [POWER] to turn power ON again.
 - The conditions selected in initial set mode are now effective.

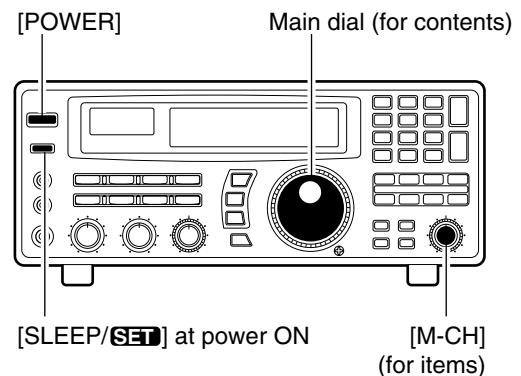

[DISPLAY EXAMPLE: INITIAL SET MODE]

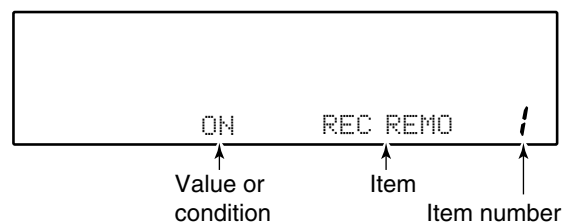

■ Quick set mode items

DIMMER

This item toggles the intensity of the display backlighting between high or low.

HIGH

Bright backlighting (default).

LOW

Dark backlighting.

BEEP

A beep sounds each time a switch is pushed for confirmation. This function can be turned OFF for silent operation.

ON

Confirmation beeps ON (default).

OFF

Confirmation beeps OFF.

LOCK

This item sets the lock function to electronically lock the main dial only or both the main dial and the panel switches.

DIAL

Only the main dial can be locked (default).

PANEL

Both the main dial and panel switches can be locked.

AUTO TS

This item sets the auto tuning speed. The main dial normally changes the frequency $[400] \times [\text{tuning step}] / \text{revolution}$. When auto tuning speed is turned on this increases to $[2000] \times [\text{tuning step}] / \text{revolution}$ during quick rotation of the dial.

ON

The auto tuning speed function is ON (default).

OFF

The auto tuning speed function is OFF.

HF ANT

This item sets the active HF antenna connector on the rear panel. Either the 50Ω (SO-239 coaxial) or 500Ω (phono RCA connector) can be activated.

50Ω

The SO-239 antenna connector is activated (default).

500Ω

The RCA (phono) connector is activated.

■ Initial set mode items

REC REMO

This item activates/deactivates the REC REMOTE jack on the front panel. When ON is selected, the [REC REMOTE] jack is at a "low" level when the squelch opens via the internal relay.

ON

The REC REMOTE jack can be used (default).

OFF

The REC REMOTE jack has no function and no relay switching sound is heard.

REC SPCH

When the optional UT-102 VOICE SYNTHESIZER is installed and scan is in use, the detected frequency is announced each time scan pauses, regardless of the [SPCH/LOCK] switch. This announcement can be turned ON and OFF.

ON

The detected frequency is announced when scan pauses (default).

OFF

The optional voice synthesizer activates via the [SPCH] switch only.

SPCH LAN

When the optional UT-102 VOICE SYNTHESIZER UNIT is installed, you can select between English and Japanese as the language.

ENG

Voice synthesizer functions in English (default).

JPN

Voice synthesizer functions in Japanese.

SPCH SPD

When the optional UT-102 VOICE SYNTHESIZER UNIT is installed, you can select between faster or slower synthesizer output.

FAST

Voice synthesizer output is faster (default).

SLOW

Voice synthesizer output is slower.

CIV ADDR

To distinguish equipment, each CI-V transceiver/receiver has its own Icom standard address in hexadecimal code. The IC-R8500's address is 4AH.

When 2 or more IC-R8500's are connected to an optional CT-17 CI-V LEVEL CONVERTER, rotate the main dial to select a different address for each IC-R8500 in the range 01H to 7FH.

4AH

Address set to 4AH (default).

01H

Address set to 01H.

CIV BAUD

This item sets the data transfer rate. When "AUTO" is selected, baud rate is automatically set according to the connected controller or other Icom CI-V radio.

AUTO

Auto baud rate (default).

19200

19200 bps

CIV TRAN

Transceive operation is possible with the IC-R8500 connected to an Icom CI-V radio. When "ON" is selected, changing the frequency, operating mode, etc. on the IC-R8500 automatically changes those of connected radios and vice versa.

ON

Transceive ON (default).

OFF

Transceive OFF.

CIV 731

When connecting the IC-R8500 to the IC-735 for transceive operation, you must change the operating frequency data length to 4 bytes.

• This item *must* be set to "ON" only when operating transceive with the IC-735.

OFF

Frequency data set to 5 bytes (default).

ON

Frequency data set to 4 bytes.

◇ RS-232C socket

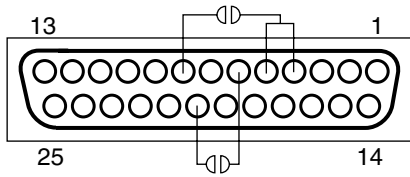

Pin	Port name	Description
1	GND	Grounded.
2	RXD	Input port for CI-V format data; +12V/-12V.
3	TXD	Output port for CI-V format data; +12V/-12V.
4	RTS CTS	Shorten these ports inside.
5		Can be connected to pin 8 (DCD) via the internal circuit board ('coffee beans').
6	DSR	NC; can be connected to pin 20 (DTR) via the internal circuit board ('coffee beans').
7	GND	Grounded.
8	DCD	NC; can be connected to pins 4 and 5 (RTS/CTS) via the internal circuit board ('coffee beans').
9-19	NC	No connection.
20	DTR	NC; can be connected to pin 6 (DSR) via the internal circuit board ('coffee beans').
21-25	NC	No connection.

◇ Remote jack

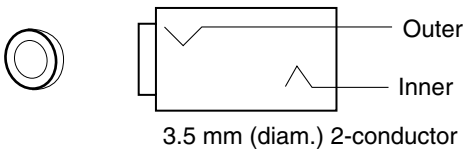

Pin	Port name	Description
Inner	REMOTE	Input/output port for CI-V format data; +5 V/0 V.
Outer	GND	Grounded.

◇ IF OUT jack

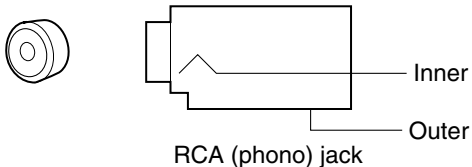

Pin	Port name	Description
Inner	IF OUT	Frequency: 10.7 MHz Output level: -60 dBm (with -50 dBm input from an antenna connector in WFM mode)
Outer	GND	Grounded.

◇ AGC OUT jack

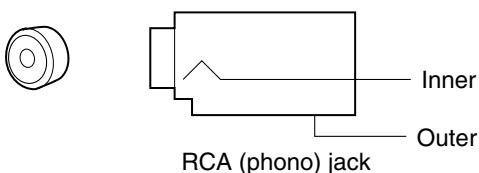

Pin	Port name	Description
Inner*	AGC out	Output voltage: 1 to -2.4 V DC (signal strength weak to strong) Output impedance: 2.2 MΩ
	Audio detect	Output level: 200 mV rms (at Mod.=1 kHz, Dev.=3.5 kHz) Output impedance: 4.7 kΩ • Before the frequency de-emphasis stage. • Usable for FM only (not including WFM).
Outer	GND	Grounded.

*Output is selectable with an internal jumper pin (p. 16).

◇ External speaker

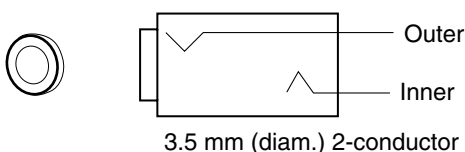

Pin	Port name	Description
Inner	AF out	Output level: More than 2 W Output impedance: 4-8 Ω
Outer	GND	Grounded.

◇ DC 13.8 V and DC IN sockets

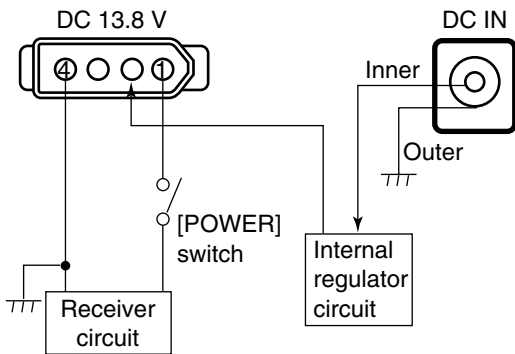

•DC IN

Pin	Port name	Description
Inner	DC IN	Accepts connection to the AD-55A/V only
Outer	GND	Grounded.

•DC 13.8 V

Pin	Port name	Description
1	13.8 IN	13.8 V DC input; current consumption 2 A
2	12.5 OUT	12.5 V DC output when connecting AD-55/A/V to [DC IN] socket. Max. 2 A
3	NC	—
4	GND	Grounded.

◇ REC REMOTE jack

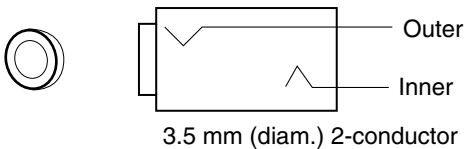

Pin	Port name	Description
Inner	SQL	<ul style="list-style-type: none"> •Grounded when squelch opens. •Can be deactivated via initial set mode. (p. 31) •Max. current: 1 A/12 V DC
Outer	GND	—

◇ REC OUT jack

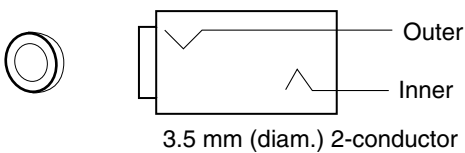

Pin	Port name	Description
Inner	DET	<ul style="list-style-type: none"> •Output detected audio output. •100–300 mV rms/4.7 kΩ
Outer	GND	Grounded.

◇ PHONES jack

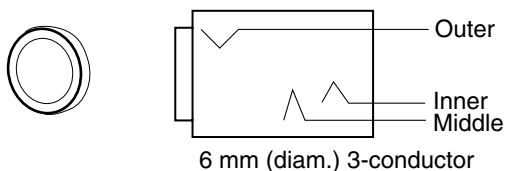

Pin	Port name	Description
Inner, Middle	Audio	<ul style="list-style-type: none"> •Outputs audio. •Output impedance: 4–16 Ω
Outer	GND	Grounded.

10 CONTROL COMMANDS

The IC-R8500 can be connected to a PC via the PC's RS-232C port. This allows you to control the receiver

from the PC and/or transfer data from the receiver to the PC.

Command table

Operation	Cn	Sc	Remark
Reading freq. edges	02	—	
Reading operating freq.	03	—	
Reading operating mode	04	—	
Reading M-ch contents package	1A	01	add bn+mc*
Reading bank name	1A	03	add bn*
Reading squelch condition	15	01	
Reading S-meter level		02	
Reading model ID	19	00	
Set frequency	05		add fd*
Set operating mode	LSB USB AM AM narrow AM wide CW CW narrow FM FM narrow WFM	06	0001
			0101
			0202
			0201
			0203
			0301
			0302
			0501
0502			
0601			
Memory channel selection	08	—	mc*
Bank selection	08	A0	bn*
Memory write	09	—	
Set M-ch contents & write package	1A	00	add dt*
Set bank name	1A	02	add bn+nd*
Memory clear	0B	—	
Stop scan		00	
Programmed scan start		02	note 1
Auto memory write scan start		04	note 1
Memory scan start		22	note 2
Select memory scan start		23	note 2
Mode select scan start		24	note 2
Priority scan		42	
SEL-CH release		B0	
SEL-CH tag		B1	
VSC deactivation		C0	
VSC activation		C1	
Scan resume selection "∞"		D0	
Scan resume selection "OFF"		D1	
Scan resume selection "DLY"		D3	

Operation	Cn	Sc	Remark
Tuning step	10	00	10 Hz
		01	50 Hz
		02	100 Hz
		03	1 kHz
		04	2.5 kHz
		05	5 kHz
		06	9 kHz
		07	10 kHz
		08	12.5 kHz
		09	20 kHz
		10	25 kHz
		11	100 kHz
		12	1 MHz
13	programmable		
Attenuator	11	00	OFF
		10	10 dB
		20	20 dB
		30	30 dB
Voice synthesizer	13	00	frequency
AF gain setting	14	01	add gd*
Squelch level setting		03	add gd*
IF shift setting		04	add gd*
APF control setting		05	add gd*
Memory clear	16	10	AGC OFF
		11	AGC ON
		20	NB OFF
		21	NB ON
		30	APF OFF
31	APF ON		
Power OFF (activating sleep)	18	00	
Power ON (from sleep active)		01	

Note 1: Only scan group 0 is usable.

Note 2: Use these commands after sending a bank or mode command.

Data format

Basic format from PC to IC-R8500

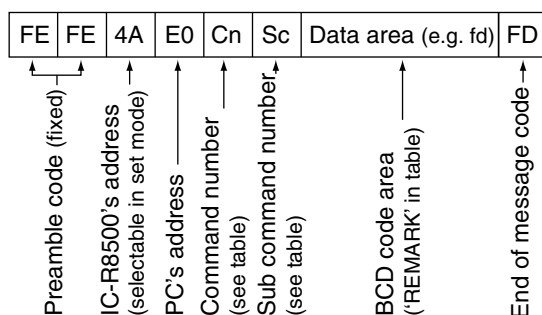

Answer from IC-R8500 to PC

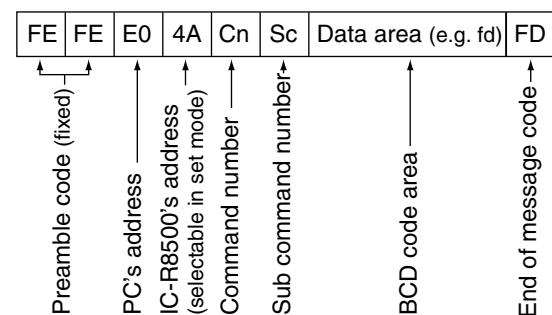

•'OK' message from IC-R8500 to PC

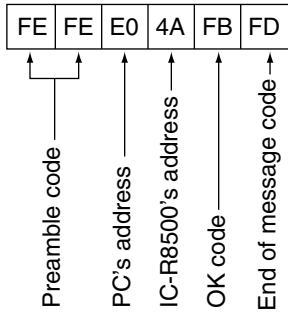

•'NG' message from IC-R8500 to PC

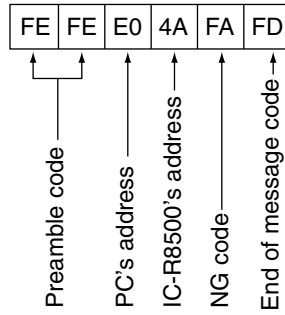

•Memory channel contents set & write (1A 00)

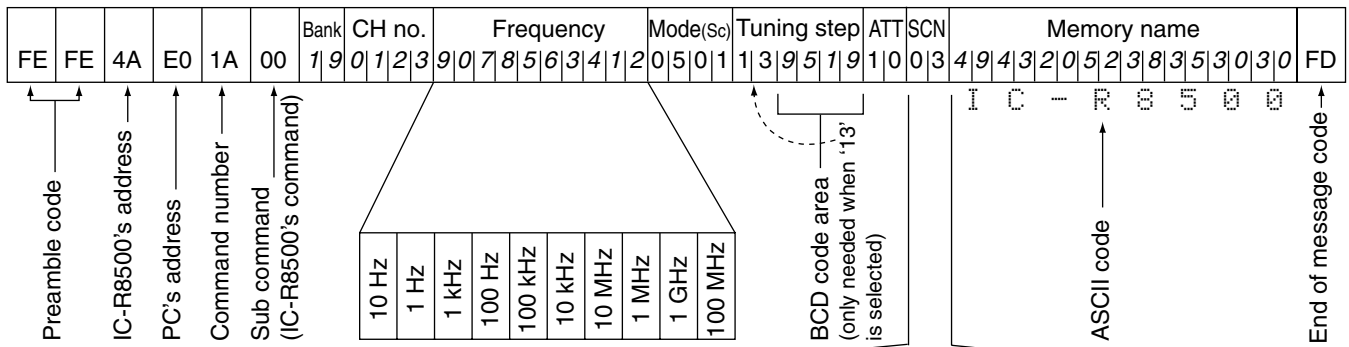

The above data packet is an example of programming the following into memory channel 123 of bank number 19:

- Frequency: 1,234,567,890 Hz
- Mode: FM
- Tuning step: 199.5 kHz (programmable step)
- Attenuator: 10 dB
- Scan select: specified
- Scan skip: specified
- Memory name: IC-R8500

Scan skip and select channels

Comment number	Scan select	Scan skip
00	OFF	OFF
01	OFF	Specified
02	Specified	OFF
03	Specified	Specified

•Clearing the specified channel data (Memory channel contents set & write)

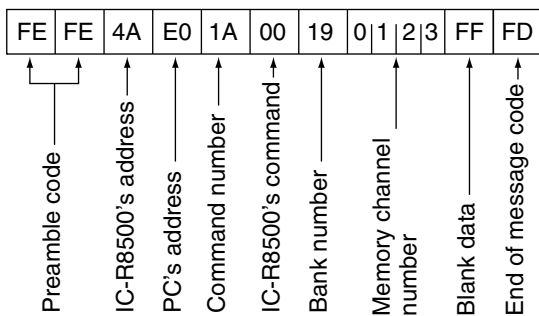

•Special bank number and channels (bn)

Special bank	Bank number	Remarks
FREE	20	<ul style="list-style-type: none"> •For programmed scan, channel numbers are as follows: 0P1=00, 0P2=01, 1P1=02, 1P2=03, etc., up to 9P1=18 and 9P2=19. •There is only one channel in the priority bank.
AUTO	21	
SKIP	22	
PROG	23	
PRI0	24	

•Gain and level data (gd; BCD data)

AF GAIN } Max. counterclockwise Max. clockwise
 SQUELCH } 0000 0255

IF SHIFT } Max. counterclockwise Max. clockwise
 APF control } 0000 0128 0255

11 MAINTENANCE

■ Disassembly

For internal maintenance and optional installations, disassemble the receiver.

CAUTION: DISCONNECT the DC power cable or AC adapter before performing any work on the receiver.

- ① Remove 6 screws from the top of the receiver and 4 screws from its sides.
- ② Carefully lift up the top cover while disconnecting the plug from the speaker cable.
- ③ Turn the receiver upside down.
- ④ Remove 6 screws from the bottom cover, then lift up the bottom cover.

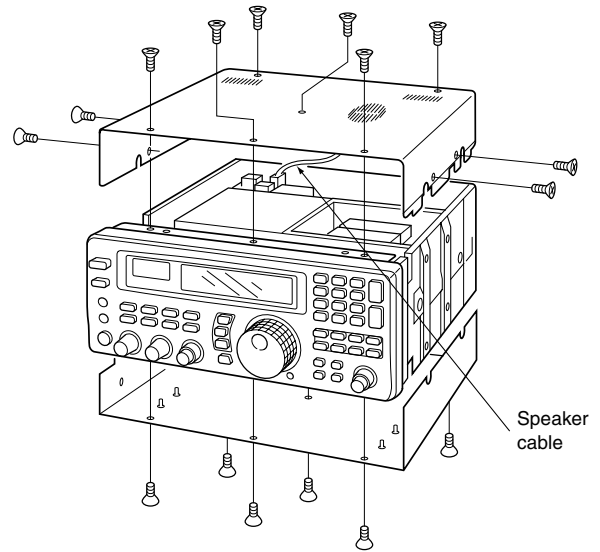

■ Fuse replacement

If a fuse blows or the receiver stops functioning, try to find the source of the problem, and replace the damaged fuse with a new, rated fuse.

- For DC cable fuse
- For internal fuse

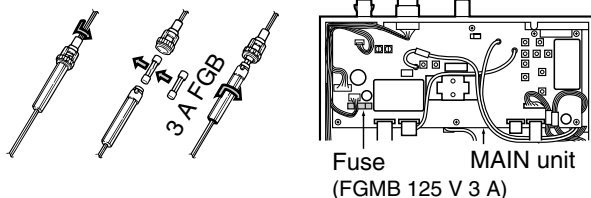

■ Level adjustments

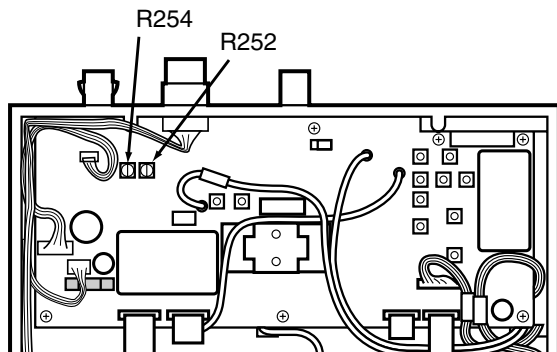

R252 adjusts the beep level
R254 adjusts the UT-102 output level

■ Memory backup

All of the CPU's memory is backed up by an EEPROM (Electrically-Erasable Programmable Read-Only Memory). All data you set, such as memory contents, set mode contents, etc. is stored in this EEPROM. There is no internal lithium battery.

■ CPU resetting

If the IC-R8500 is behaving erratically, this may be an indication of a CPU malfunction. In such cases, reset the CPU.

While pushing [MW], push [POWER] in to turn on the receiver power.

- The CPU is reset.

NOTE: Resetting the CPU clears all memory contents and returns internal settings to their factory defaults.

■ Cleaning

If the receiver becomes dusty or dirty, wipe it clean with a dry, soft cloth.

AVOID the use of strong chemical solvents such as thinner, benzene or alcohol to clean the receiver. These may damage the receiver's surfaces.



■ UT-102 VOICE SYNTHESIZER UNIT

The UT-102 announces the accessed frequency in a clear, electronically generated voice, in English (or Japanese) when pushing [SPCH] or when a signal is detected during scan (see p. 31, 32 for settings).

- ① Remove the top cover as shown opposite.
- ② Remove the protected paper attached to the bottom of the UT-102 to expose the adhesive strip.
- ③ Connect the UT-102 as shown in the diagram at right.
- ④ Replace the top cover.

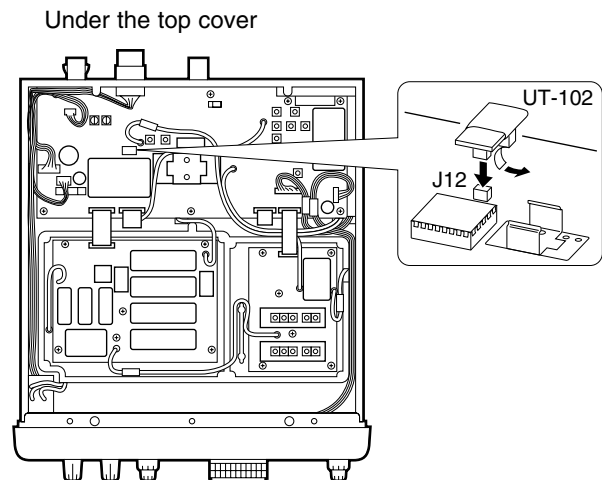

■ FL-52A CW NARROW FILTER

The IC-R8500 has a CW narrow mode which provides better S/N (signal-to-noise) and also rejects nearby interference. The CW narrow filter is helpful when receiving CW and radio-teletype signals.

- ① Remove the top cover as shown opposite.
- ② Connect the FL-52A as shown in the diagram at right.
 - Make sure it is connected in the proper orientation.
 - Attached nuts on the FL-52A are not necessary. If you want to install the filter more securely, open the MAIN unit, then use the nuts on the bottom of the MAIN unit.
- ③ Replace the top cover.

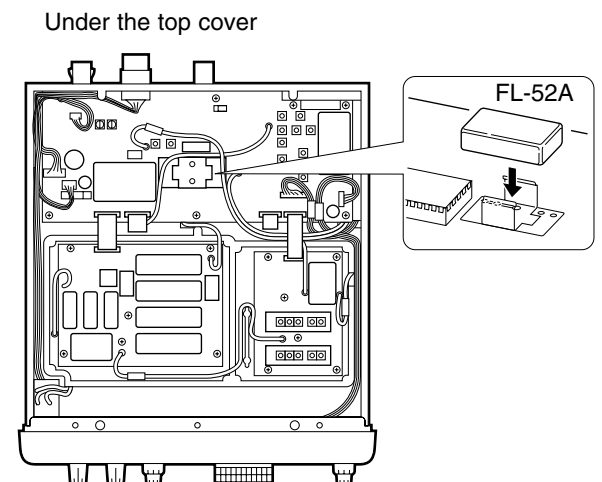

■ CR-293 HIGH STABILITY CRYSTAL UNIT

A temperature-compensating crystal with a stability of ± 3 ppm is built-in to the receiver. For more demanding operation, the CR-293 HIGH STABILITY CRYSTAL UNIT is available. It has a stability of ± 0.5 ppm.

- ① Remove the bottom cover as shown on p. 37.
- ② Remove 6 screws from the metal plate, then remove the metal plate and shield cover.

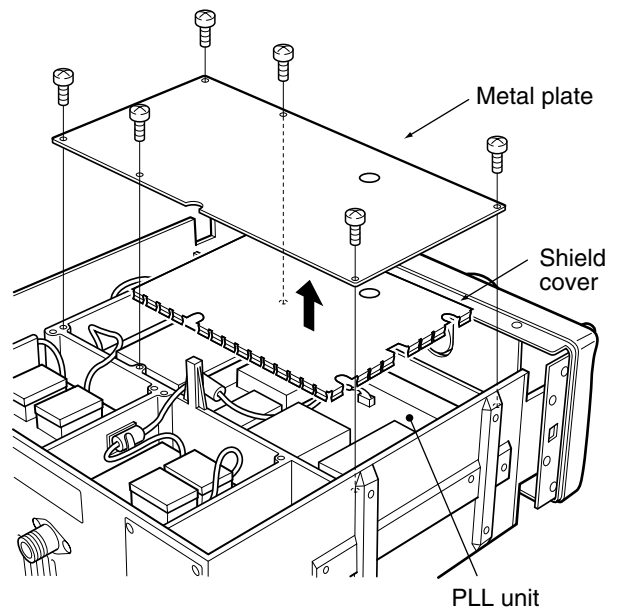

- ③ Remove 10 screws from the PLL unit, then open the unit to expose the bottom.
- ④ Unsolder the feet of the internal crystal unit, then remove it.
- ⑤ Place the CR-293 in the space available as shown in the diagram, then solder its feet into place (6 points).
- ⑥ Adjust the reference frequency using a frequency counter.

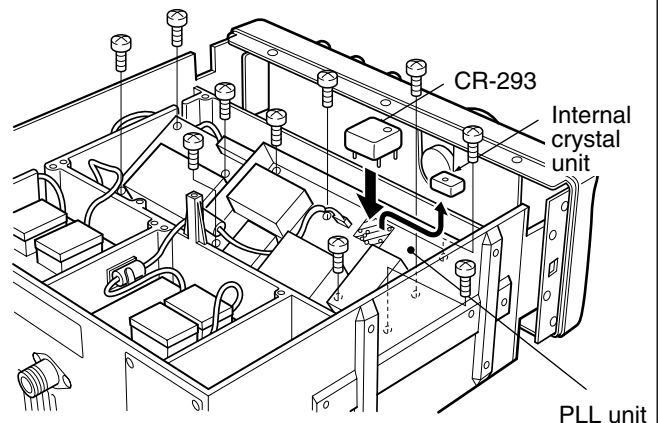

- ⑦ Replace the ground spring to its original position.
- ⑧ Return the shield cover, metal plate and bottom cover to their original positions.

/// **NOTE:** The CR-293 is an oven-type crystal unit, and the specified frequency stability described above is guaranteed 1 min. after power ON.

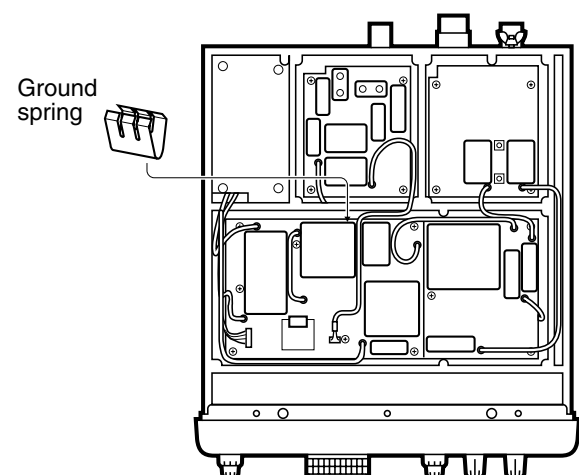

The following chart is designed to help you correct problems which are not equipment malfunctions. If you are unable to locate the cause of a problem or

solve it through the use of this chart, contact your nearest Icom Dealer or Service Center.

	PROBLEM	POSSIBLE CAUSE	SOLUTION	REF.
POWER	Power does not turn ON when [POWER] is pushed in.	<ul style="list-style-type: none"> • DC power cable is improperly connected. • A fuse is blown. • During AC adapter operation, the jumper connector is not in use. • External 12 V DC is connected to the [DC IN] jack. 	<ul style="list-style-type: none"> • Reconnect the DC power cable securely. • Check for the cause, then replace the fuse with a spare one. • Connect the jumper connector to the [DC13.8V] jack on the receiver's rear panel. • Connect the external power source to the [DC13.8V] jack. The [DC IN] jack accepts an AC adapter (AD-55/A/V) only. 	<p>p. 8</p> <p>p. 37</p> <p>p. 8</p> <p>p. 8</p>
	Receiver turns OFF by itself.	<ul style="list-style-type: none"> • The sleep timer has been activated. 	<ul style="list-style-type: none"> • Turn power back ON, then push [SLEEP] one or more times to turn the sleep timer function OFF, if desired. 	p. 29
RECEIVE FUNCTIONS	No sound comes from the speaker.	<ul style="list-style-type: none"> • Volume level is too low. • The squelch is closed. • An external speaker or headphones are connected. • CW narrow mode is selected when no optional filter is installed. 	<ul style="list-style-type: none"> • Rotate [AF GAIN] clockwise to obtain a suitable listening level. • Rotate [SQUELCH] counterclockwise to open the squelch. • Disconnect the external speaker or headphones. • Select another mode or install the optional CW narrow filter. 	<p>—</p> <p>p. 14</p> <p>—</p> <p>pgs. 13, 38</p>
	Sensitivity is low.	<ul style="list-style-type: none"> • The coaxial cable is cut. • No antenna is connected. • The connected antenna is not matched to the receive frequency. • Wrong antenna connector is used for V/UHF and HF antenna. • Wrong antenna connector is selected in set mode for HF antenna. • An RF attenuator is activated. 	<ul style="list-style-type: none"> • Fix the coaxial cable. • Connect an antenna. • Connect an antenna matched to the receiving frequency. • Check the antenna connection. • Select the proper antenna connector: SO-239 or phono (RCA). • Push [ATT 10 dB] or [ATT 20 dB] to cancel the function. 	<p>—</p> <p>p. 8</p> <p>p. 8</p> <p>p. 8</p> <p>p. 31</p> <p>—</p>
	Receive signal is unclear or distorted.	<ul style="list-style-type: none"> • [IF SHIFT] is rotated too far CCW or CW. • [APF] is rotated too far CCW or CW. • The wrong mode switch is pushed. 	<ul style="list-style-type: none"> • Set [IF SHIFT] to the center position. • Set the [APF] control to the center position or push the [APF] switch to turn it OFF. • Push the correct mode switch. 	<p>p. 14</p> <p>p. 15</p> <p>p. 13</p>
	WFM mode cannot be set.	<ul style="list-style-type: none"> • The operating frequency is lower than 30 MHz. (WFM mode cannot be selected below 30 MHz.) 	<ul style="list-style-type: none"> • Set the frequency above 30 MHz when in WFM mode. 	p. 13
FRONT PANEL CONTROL	Main dial does not function.	<ul style="list-style-type: none"> • The lock function is activated. 	<ul style="list-style-type: none"> • Push [LOCK] for 1 sec. to deactivate. 	p. 12
	[LOCK] does not lock the keypad, function switches, etc.	<ul style="list-style-type: none"> • DIAL LOCK is selected in quick set mode. 	<ul style="list-style-type: none"> • Select PANEL LOCK in quick set mode. 	p. 31
	The selected frequency is erased.	<ul style="list-style-type: none"> • The memory channel was changed before writing into memory. 	<ul style="list-style-type: none"> • Push [MW] for 1 sec. to write into a memory before changing channels. 	p. 19
	The frequency is not announced when pushing [SPCH].	<ul style="list-style-type: none"> • An optional UT-102 VOICE SYNTHESIZER UNIT is not installed. 	<ul style="list-style-type: none"> • Install the UT-102. 	p. 38

	PROBLEM	POSSIBLE CAUSE	SOLUTION	REF.
MEMORY CHANNELS	Memory channels in another bank cannot be selected.	<ul style="list-style-type: none"> The bank limit function is activated and "BANK" is indicated. 	<ul style="list-style-type: none"> Push [BANK] to turn OFF the bank limit function or use [BANK] or [BANK] to select the bank. 	p. 18
	Memory channels in the 'AUTO' bank are cleared.	<ul style="list-style-type: none"> Written memories condition is set as CL&START. 	<ul style="list-style-type: none"> Change the setting to START. 	p. 24
	Bank name is erased after setting.	<ul style="list-style-type: none"> [CE ▶] is pushed on the final name character. 	<ul style="list-style-type: none"> Push [ENT] after setting the name. 	p. 20
	Memory name cannot be written.	<ul style="list-style-type: none"> A frequency has not yet been programmed into the memory channel. [MW] key is used for name programming. 	<ul style="list-style-type: none"> Push [MW] for 1 sec. in advance. Push [ENT] after setting the name. 	p. 19 p. 20
SCAN	No scan will function.	<ul style="list-style-type: none"> [SQUELCH] is open and [∞] is selected. 	<ul style="list-style-type: none"> Turn [SQUELCH] CW until noise disappears. 	p. 14
	Programmed scan and auto memory write scan does not function.	<ul style="list-style-type: none"> The same frequencies are programmed into the selected scanning group. 	<ul style="list-style-type: none"> Reprogram different frequencies into scan edge channels or select a different programmed scan group. 	p. 27
	Memory scan does not function.	<ul style="list-style-type: none"> All channels are specified as "SKIP" channels in the selected bank. No memory channels have yet been programmed in the selected bank. 	<ul style="list-style-type: none"> Turn OFF the automatic skip function or release the "SKIP" setting for 2 or more channels in the selected bank. Program 2 or more channels in the selected bank. 	pgs. 25, 26 p. 19
	Select memory scan does not function.	<ul style="list-style-type: none"> Two or more "SEL-CH" are not specified in the selected bank. 	<ul style="list-style-type: none"> Set 2 or more channels as "SEL-CH" in the selected bank. 	p. 23
	Auto memory write scan does not function.	<ul style="list-style-type: none"> All channels in the auto memory bank have been programmed. 	<ul style="list-style-type: none"> Erase some or all of the channels in the auto write bank. 	p. 24
	Scan starts automatically.	<ul style="list-style-type: none"> The AFC function is activated and an off-center signal is received in FM or WFM mode. 	<ul style="list-style-type: none"> Push [AFC] to turn the AFC function OFF or wait until the center frequency is selected. 	p. 14

General

- Frequency coverage :

Version	Frequency Coverage (MHz)		
U.S.A.	0.10000– 823.99999		
	849.00001– 868.99999	894.00001–	1999.99999*
Europe	0.10000– 1999.99999*		
France	0.10000– 87.50000	108.00000–	1999.99999*

*Specifications guaranteed 0.1–1000 MHz and 1240–1300 MHz
- Mode : FM (normal/narrow), AM (wide/normal/narrow), SSB (USB/LSB) CW (normal/narrow*), WFM
 *Optional FL-52A is required.
- Number of memory channels : 1000 (plus 20 scan edges and 1 priority channel)
- Antenna connector : Below 30 MHz SO-239 (50 Ω)/Phono (500 Ω)
 Above 30 MHz Type-N (50 Ω)
- Usable temperature range : –10°C to +50°C (+14°F to +122°F)
- Frequency stability : Below 30 MHz ±100 Hz (±20 Hz*)
 Above 30 MHz ± 0.0003 % (±0.00006%*)
 *When an optional CR-293 is installed.
- Power supply requirement : 13.8 V DC ±15% (negative ground)
 117 V AC (U.S.A. version with supplied AD-55A)
 230 or 240 V AC (other versions with the optional AD-55/V)
- Current drain (at 13.8 V DC) : Standby 1.8 A Max. audio 2.0 A
- Dimensions (projections not included) : 287(W)×112(H)×309(D) mm; 11⁵/₁₆(W)×4¹³/₃₂(H)×12³/₁₆(D) in
- Weight : 7.0 kg (15.4 lb)
- Intermediate frequencies :

Frequency band	1st	2nd	3rd*	Unit: MHz
0.1– 29.99999	48.8	10.7	0.455	
30.0– 499.99999	778.7	10.7	0.455	
500.0– 1024.99999	266.7	10.7	0.455	
1025.0– 1999.99999	Utilizes converter method: Local freq.: 500, 1000 or 1010 MHz			

*Except WFM.

Receiver

- Receive system : Superheterodyne
- Sensitivity :

Frequency band (MHz)	SSB/CW	AM	AM-N	AM-W	FM	WFM
0.1–0.49999	1.0 μV	6.3 μV	—	—	—	—
0.5–1.79999	2.0 μV	13.0 μV	—	—	—	—
1.8–1.99999	0.25 μV	3.2 μV	2.5 μV	—	—	—
2.0–27.99999	0.2 μV	2.5 μV	2.0 μV	—	—	—
28.0–29.99999	0.2 μV	2.5 μV	2.0 μV	—	0.5 μV	—
30.0–999.99999	0.32 μV	2.5 μV	2.0 μV	3.2 μV	0.5 μV	1.4 μV
1240.0–1300.00000	0.32 μV	2.5 μV	2.0 μV	3.2 μV	0.5 μV	2.0 μV
- Squelch sensitivity :

Frequency band (MHz)	SSB/CW/AM-N		AM/AM-W		FM		WFM	
	threshold	tight	threshold	tight	threshold	tight	threshold	tight
1.8–29.99999	10 μV	320 mV	0.5 μV	320 mV	0.5 μV*	320 mV*	—	—
30–1000 1240–1300	4.5 μV	320 mV	0.4 μV	320 mV	0.4 μV	320 mV	4.5 μV	320 mV

*FM mode can only be used above 28 MHz.
- Selectivity : WFM More than 150 kHz/–6 dB
 FM/AM-W More than 12 kHz/–6 dB
 FM-N/AM More than 5.5 kHz/–6 dB
 AM-N/SSB/CW More than 2.2 kHz/–6 dB
 CW narrow* More than 500 Hz/–6 dB
 *Optional FL-52A is required.
- Spurious and image rejection ratio : Below 30 MHz More than 60 dB
 30–1000 MHz 50 dB (typical)
 1240–1300 MHz
- Audio output power : More than 2.0 W at 10% distortion with an 8 Ω load
- IF shift variable range : More than ±1.2 kHz
- External speaker connector : 2-conductor 3.5 mm (1/8")/4–8 Ω

All specifications are subject to change without notice or obligation.

15 OPTIONS

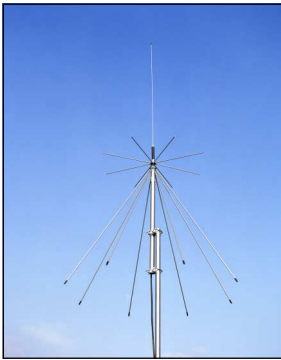

AH-7000 SUPER WIDEBAND OMNIDIRECTIONAL ANTENNA

Frequency coverage:
Receive 25–1300 MHz
Transmit 50, 144, 430, 900,
1200 MHz bands
Type of antenna: Discone
Weight: 1 kg

SP-21 EXTERNAL SPEAKER



Designed for base station operation.
Input impedance: 8 Ω
Max. input power: 5 W

MB-23 CARRYING HANDLE



Carrying handle, convenient for portable operation. Use the screws supplied with the IC-R8500; DO NOT use the screws supplied with the MB-23.

CT-17 CI-V LEVEL CONVERTER



For remote control of up to 4 receivers from 1 PC. You can set memory contents, including names, as well as read data from the receivers.

AD-55/A/V AC ADAPTER



Provides AC operation.
CE (AD-55 Europe version only)

IC-MB12 MOBILE MOUNTING BRACKET



Receiver mounting bracket for mobile operation.
Not available in European countries due to local regulations.

CR-293 HIGH STABILITY CRYSTAL UNIT

Provides improved frequency stability.

- Frequency stability: ± 5 ppm (0°C – $+60^{\circ}\text{C}$; 32°F – $+140^{\circ}\text{F}$)

FL-52A CW NARROW FILTER

(455 kHz; 500Hz/–6 dB)

UT-102 VOICE SYNTHESIZER UNIT



We Icom Inc. Japan
 1-1-32, Kamiminami, Hirano-ku
 Osaka 547-0003, Japan

Declare on our sole responsibility that this equipment complies with the essential requirements of the Radio and Telecommunications Terminal Equipment Directive, 1999/5/EC, and that any applicable Essential Test Suite measurements have been performed.

Kind of equipment: COMMUNICATIONS RECEIVER

Type-designation: IC-R8500

Version (where applicable):

This compliance is based on conformity with the following harmonised standards, specifications or documents:

- i) Article 3.1a EN 60950-1: 2001
- ii) Article 3.1b EN 301489-1 and EN 301489-15
- iii) Article 3.2 EN 301 783-2
- iv)
- v)

DECLARATION OF CONFORMITY



Düsseldorf 4th Aug. 2006
 Place and date of issue

Icom (Europe) GmbH
 Himmelgeister straÙe 100
 D-40225 Düsseldorf

Authorized representative name
 H. Ikegami
 General Manager

Signature

Icom Inc.

Count on us!

#23 EUR

<Intended Country of Use>			
<input checked="" type="checkbox"/> GER	<input type="checkbox"/> FRA	<input checked="" type="checkbox"/> ESP	<input checked="" type="checkbox"/> SWE
<input checked="" type="checkbox"/> AUT	<input checked="" type="checkbox"/> NED	<input checked="" type="checkbox"/> POR	<input checked="" type="checkbox"/> DEN
<input checked="" type="checkbox"/> GBR	<input checked="" type="checkbox"/> BEL	<input checked="" type="checkbox"/> ITA	<input checked="" type="checkbox"/> FIN
<input checked="" type="checkbox"/> IRL	<input checked="" type="checkbox"/> LUX	<input checked="" type="checkbox"/> GRE	<input checked="" type="checkbox"/> SUI
<input checked="" type="checkbox"/> NOR			



Free Manuals Download Website

<http://myh66.com>

<http://usermanuals.us>

<http://www.somanuals.com>

<http://www.4manuals.cc>

<http://www.manual-lib.com>

<http://www.404manual.com>

<http://www.luxmanual.com>

<http://aubethermostatmanual.com>

Golf course search by state

<http://golfingnear.com>

Email search by domain

<http://emailbydomain.com>

Auto manuals search

<http://auto.somanuals.com>

TV manuals search

<http://tv.somanuals.com>