

# IMAGE<sup>®</sup> 10.6 Q

Model No. 831.297572

Serial No. \_\_\_\_\_

Write the serial number in the space above for future reference.

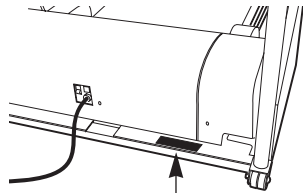

Serial Number Decal



## **⚠ CAUTION**

Read all precautions and instructions in this manual before using this equipment. Save this manual for future reference.

## **USER'S MANUAL**

---

# TABLE OF CONTENTS

IMPORTANT PRECAUTIONS .....	2
BEFORE YOU BEGIN .....	4
ASSEMBLY .....	5
HOW TO USE THE HEART RATE MONITOR .....	6
OPERATION AND ADJUSTMENT .....	7
HOW TO FOLD AND MOVE THE TREADMILL .....	17
MAINTENANCE AND TROUBLE-SHOOTING .....	18
CONDITIONING GUIDELINES .....	20
PART LIST .....	22
ORDERING REPLACEMENT PARTS .....	Back Cover
FULL ONE YEAR WARRANTY .....	Back Cover

Note: An EXPLODED DRAWING is attached at the center of this manual. Save the EXPLODED DRAWING for future reference.

---

## IMPORTANT PRECAUTIONS

**⚠ WARNING:** To reduce the risk of burns, fire, electric shock, or injury to persons, read the following important precautions and information before operating the treadmill.

1. It is the responsibility of the owner to ensure that all users of this treadmill are adequately informed of all warnings and precautions.
2. Use the treadmill only as described in this manual.
3. Place the treadmill on a level surface, with eight feet of clearance behind it. Do not place the treadmill on any surface that blocks air openings. To protect the floor or carpet from damage, place a mat under the treadmill.
4. Keep the treadmill indoors, away from moisture and dust. Do not put the treadmill in a garage or covered patio, or near water.
5. Do not operate the treadmill where aerosol products are used or where oxygen is being administered.
6. Keep children under the age of 12 and pets away from the treadmill at all times.
7. The treadmill should not be used by persons weighing more than 250 pounds.
8. Never allow more than one person on the treadmill at a time.
9. Wear appropriate exercise clothing when using the treadmill. Do not wear loose clothing that could become caught in the treadmill.
10. Athletic support clothes are recommended for both men and women. Always wear athletic shoes. Never use the treadmill with bare feet, wearing only stockings, or in sandals.
10. When connecting the power cord (see HOW TO PLUG IN THE POWER CORD on page 7), plug the power cord into a surge protector (not included) and plug the surge protector into a grounded circuit capable of carrying 15 or more amps. No other appliance should be on the same circuit.
11. Use only a single-outlet surge suppressor that is UL 1449 listed as a transient voltage surge suppressor (TVSS). The surge suppressor must have a UL suppressed voltage rating of 400 volts or less and a minimum surge dissipation of 450 joules. The surge suppressor must be electrically rated for 120 volts AC and 15 amps.
12. Keep the power cord and the surge suppressor away from heated surfaces.
13. Never move the walking belt while the power is turned off. Do not operate the treadmill if the power cord or plug is damaged, or if the treadmill is not working properly. (See BEFORE YOU BEGIN on page 4 if the treadmill is not working properly.)

14. Never start the treadmill while you are standing on the walking belt. Always hold the handrails while using the treadmill.
15. The treadmill is capable of high speeds. Adjust the speed in small increments to avoid sudden jumps in speed.
16. To reduce the possibility of the treadmill overheating, do not operate the treadmill continuously for longer than one hour.
17. The heart rate monitor is not a medical device. Various factors, including the user's movement, may affect the accuracy of heart rate readings. The heart rate monitor is intended only as an exercise aid in determining heart rate trends in general.
18. Never leave the treadmill unattended while it is running. Always remove the key, unplug the power cord and move the on/off switch to the "off" position when the treadmill is not in use. (See the drawing on page 4 for the location of the on/off switch.)
19. Do not attempt to raise, lower, or move the treadmill until it is properly assembled. (See ASSEMBLY on page 5, and HOW TO MOVE

THE TREADMILL on page 17.) You must be able to safely lift 45 pounds (20 kg) in order to raise, lower, or move the treadmill.

20. When folding or moving the treadmill, make sure that the storage latch is fully closed.
21. Inspect and tighten all parts of the treadmill every three months.
22. Never insert any object into any opening.
23. The roller guards must be 1/8 inch from the rear roller. Remove the key and adjust the roller guards, if necessary.
24. Always unplug the power cord before performing the maintenance and adjustment procedures described in this manual. Never remove the motor hood unless instructed to do so by an authorized service representative. Servicing other than the procedures in this manual should be performed by an authorized service representative only.
25. This treadmill is intended for in-home use only. Do not use this treadmill in any commercial, rental, or institutional setting.

## SAVE THESE INSTRUCTIONS

**⚠ WARNING:** Before beginning this or any exercise program, consult your physician. This is especially important for persons over the age of 35 or persons with pre-existing health problems. Read all instructions before using. SEARS assumes no responsibility for personal injury or property damage sustained by or through the use of this product.

The decals shown below have been placed on your treadmill. If a decal is missing, or if it is not legible, please call our toll-free HELPLINE to order a free replacement decal (see ORDERING REPLACEMENT PARTS on the back cover). Apply the decal in the location shown.

### ⚠ WARNING

- Never allow children to play on or around treadmill.
- Storage latch must be fully engaged before treadmill is moved or stored.

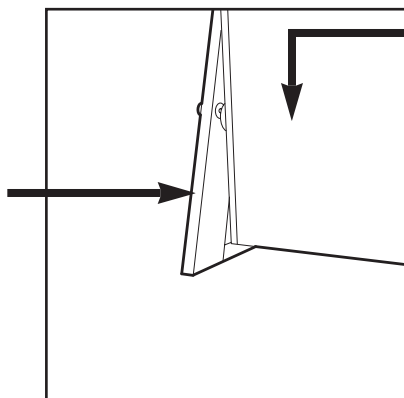

**IMPORTANT:** Incline must be set at lowest level before folding treadmill into storage position.

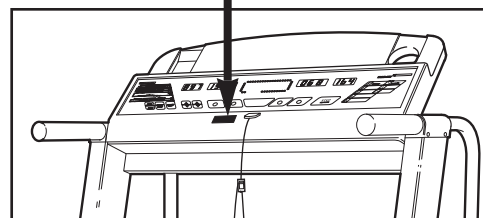

# BEFORE YOU BEGIN

Thank you for selecting the IMAGE® 10.6Q treadmill. The IMAGE® 10.6Q treadmill combines advanced technology with innovative design to let you enjoy an effective form of cardiovascular exercise in the convenience and privacy of your home. And when you're not exercising, the unique IMAGE® 10.6Q can be folded up, requiring less than half the floor space of other treadmills.

**For your benefit, read this manual carefully before using the treadmill.** If you have questions after reading the manual, please call our toll-free HELPLINE at

1-800-736-6879, Monday through Saturday, 7 a.m. until 7 p.m. Central Time (excluding holidays). To help us assist you, please note the product model number and serial number before calling. The model number of the treadmill is 831.297572. The serial number can be found on a decal attached to the treadmill (see the front cover of this manual for the location).

Before reading further, please review the drawing below and familiarize yourself with the parts that are labeled.

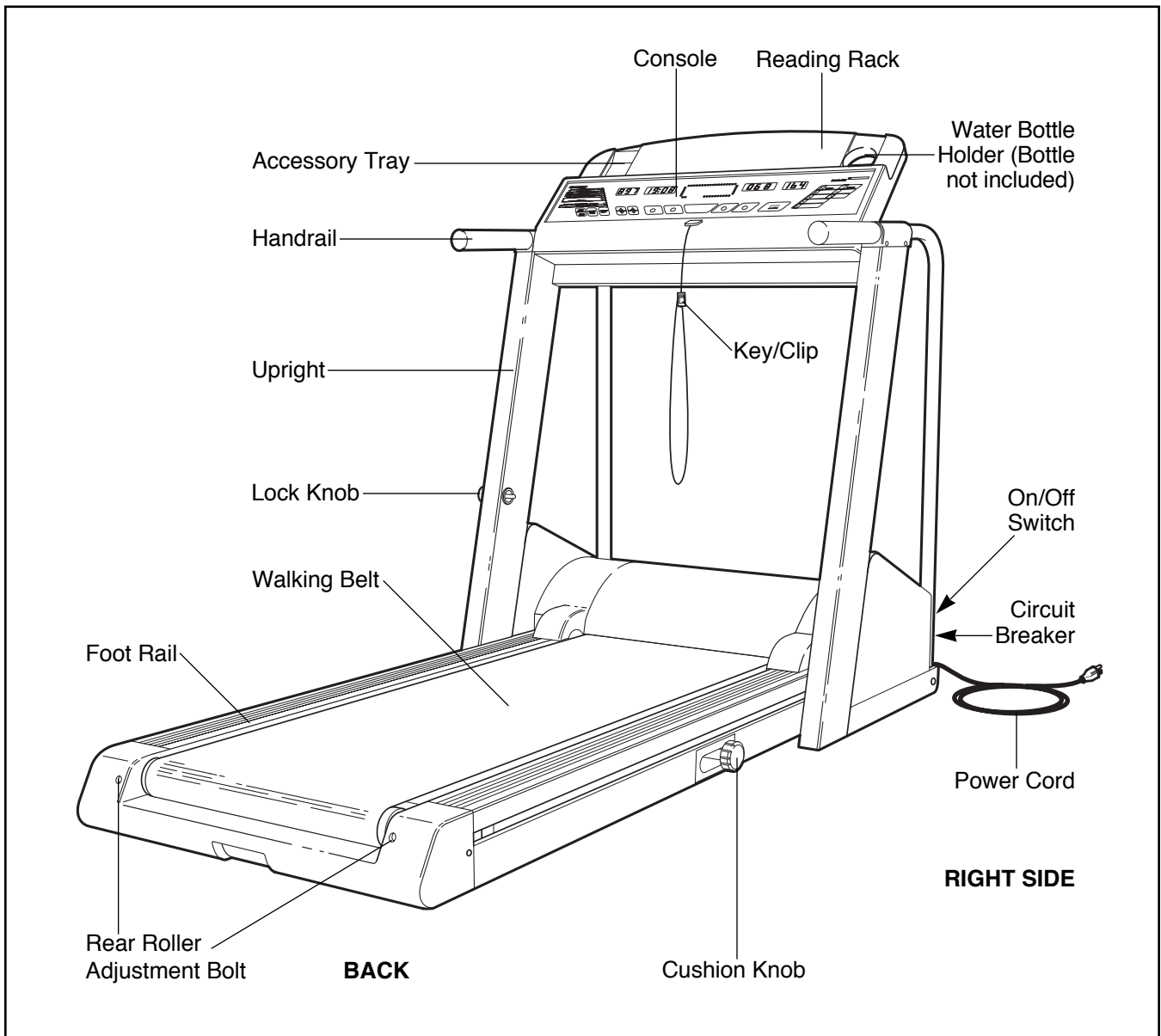

# ASSEMBLY

**Assembly requires two people.** Set the treadmill in a cleared area and remove all packing materials. Do not dispose of the packing materials until assembly is completed. **No tools are required for assembly.**

1. With the help of a second person, carefully raise the Uprights (115) until the treadmill is in the position shown.

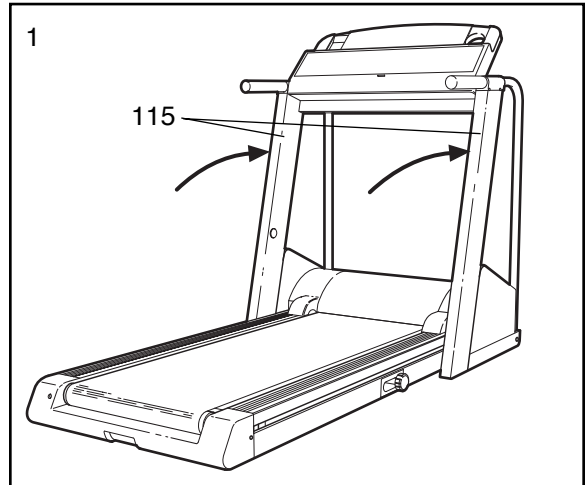

2. Press the Lock Knob Sleeve (100) into the left Upright (115).

Remove the Lock Knob (99) from the Lock Pin (103). Make sure that the Lock Pin Collar (102) and the Spring (101) are on the Lock Pin. Insert the Lock Pin into the left Upright (115) and tighten the Lock Knob onto the Lock Pin.

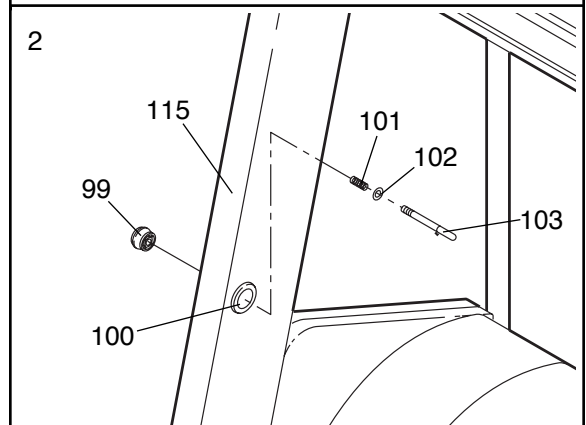

3. Remove the backing from the Adhesive Clip (94). Press the Adhesive Clip onto the base of the Uprights (115) in the indicated location. Press the Allen Wrench (95) into the Adhesive Clip.

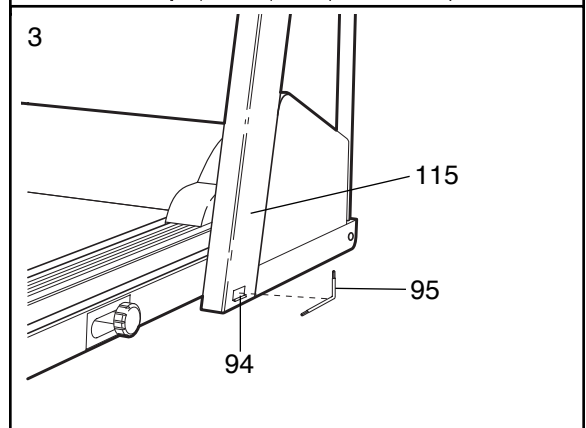

4. **Make sure that all parts are tightened before you use the treadmill. Place a mat under the treadmill to protect the floor or carpet.**

# HOW TO USE THE HEART RATE MONITOR

## HOW TO PUT ON THE HEART RATE MONITOR

The heart rate monitor consists of two components: the chest strap and the sensor unit (see the drawing below). Insert the tab on one end of the chest strap through one of the holes in the sensor unit. Press the end of the sensor unit under the buckle on the chest strap. The tab should be almost flush with the front of the sensor unit.

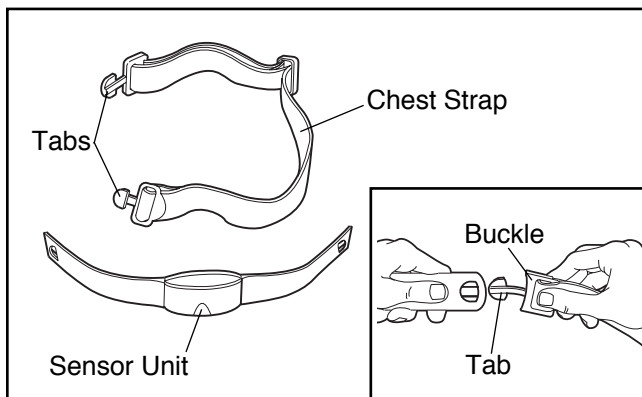

Next, wrap the heart rate monitor around your chest and attach the other end of the chest strap to the sensor unit. Adjust the length of the chest strap, if necessary. The heart rate monitor

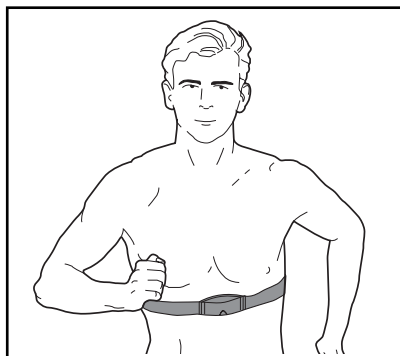

should be under your clothing, tight against your skin, and as high under the pectoral muscles or breasts as is comfortable. Make sure that the logo on the sensor unit is facing forward and is right-side-up.

Pull the sensor unit away from your body a few inches and locate the two electrode areas on the inner side. The electrode areas are the areas covered by shallow ridges. Using saline solution such as saliva or contact lens solution, wet both electrode areas. Return the sensor unit to a position against your chest.

## HEART RATE MONITOR CARE AND MAINTENANCE

- Thoroughly dry the heart rate monitor after each use. The heart rate monitor is activated when the electrode areas are wetted and the heart rate monitor is put on; the heart rate monitor shuts off when it is removed and the electrode areas are dried. If the heart rate monitor is not dried after each use, it may remain activated longer than necessary, draining the battery prematurely.
- Store the heart rate monitor in a warm, dry place. Do not store the heart rate monitor in a plastic bag or other container that may trap moisture.
- Do not expose the heart rate monitor to direct sunlight for extended periods of time; do not expose it to temperatures above 122° Fahrenheit (50° Celsius) or below 14° Fahrenheit (-10° Celsius).
- Do not excessively bend or stretch the sensor unit when using or storing the heart rate monitor.
- Clean the sensor unit using a damp cloth—never use alcohol, abrasives, or chemicals. The chest strap may be hand washed and air dried.

## HEART RATE MONITOR TROUBLE-SHOOTING

The instructions on the following pages explain how the heart rate monitor is used with the console. If the letters “PLS” appear in the PULSE/CALORIES display or if the displayed heart rate is excessively high or low, try the steps below.

- Make sure that the heart rate monitor is under your clothing, tight against your skin, and as high under the pectoral muscles or breasts as is comfortable. The logo on the sensor unit must be facing forward and be right-side-up. Note: If the heart rate monitor does not function when positioned as described, try moving it slightly lower or higher on your chest.
- Use saline solution such as saliva or contact lens solution to wet the two electrode areas on the sensor unit. If heart rate readings do not appear until you begin perspiring, re-wet the electrode areas.
- As you walk or run on the treadmill, position yourself near the center of the walking belt. **For the console to display heart rate readings, the user must be within arm’s length of the console.**
- The heart rate monitor is designed to work with people who have normal heart rhythms. Heart rate reading problems may be caused by medical conditions such as premature ventricular contractions (pvc’s), tachycardia bursts, and arrhythmia.
- The operation of the heart rate monitor can be affected by magnetic interference caused by high power lines or other sources. If it is suspected that this is a problem, try relocating the treadmill.
- The CR2032 battery may need to be replaced.

# OPERATION AND ADJUSTMENT

## THE PERFORMANT LUBE™ WALKING BELT

Your treadmill features a walking belt coated with PERFORMANT LUBE™, a high-performance lubricant. **IMPORTANT: Never apply silicone spray or other substances to the walking belt or the walking platform. Such substances will deteriorate the walking belt and cause excessive wear.**

## HOW TO PLUG IN THE POWER CORD

**⚠ DANGER:** Improper connection of the equipment-grounding conductor can result in an increased risk of electric shock. Check with a qualified electrician or serviceman if you are in doubt as to whether the product is properly grounded. Do not modify the plug provided with the product—if it will not fit the outlet, have a proper outlet installed by a qualified electrician.

Your treadmill, like any other type of sophisticated electronic equipment, can be seriously damaged by sudden voltage changes in your home's power. Voltage surges, spikes, and noise interference can result from weather conditions or from other appliances being turned on or off. **To decrease the possibility of your treadmill being damaged, always use a surge suppressor with your treadmill (see drawing 1 at the right).**

Surge suppressors are sold at most hardware stores and department stores. Use only a single-outlet surge suppressor that is UL 1449 listed as a transient voltage surge suppressor (TVSS). The surge suppressor must have a UL suppressed voltage rating of 400 volts or less and a minimum surge dissipation of 450 joules. The surge suppressor must be electrically rated for 120 volts AC and 15 amps.

**This product must be grounded.** If it should malfunction or break down, grounding provides a path of least resistance for electric current to reduce the risk of electric shock. This product is equipped with a cord having an equipment-grounding conductor and a grounding plug. **Plug the power cord into a surge suppressor, and plug the surge suppressor into an appropriate outlet that is properly installed and grounded in accordance with all local codes and ordinances.**

This product is for use on a nominal 120-volt circuit, and has a grounding plug that looks like the plug illustrated in drawing 1 below. A temporary adapter that looks like the adapter illustrated in drawing 2 may be used to connect the surge suppressor to a 2-pole receptacle as shown in drawing 2 if a properly grounded outlet is not available.

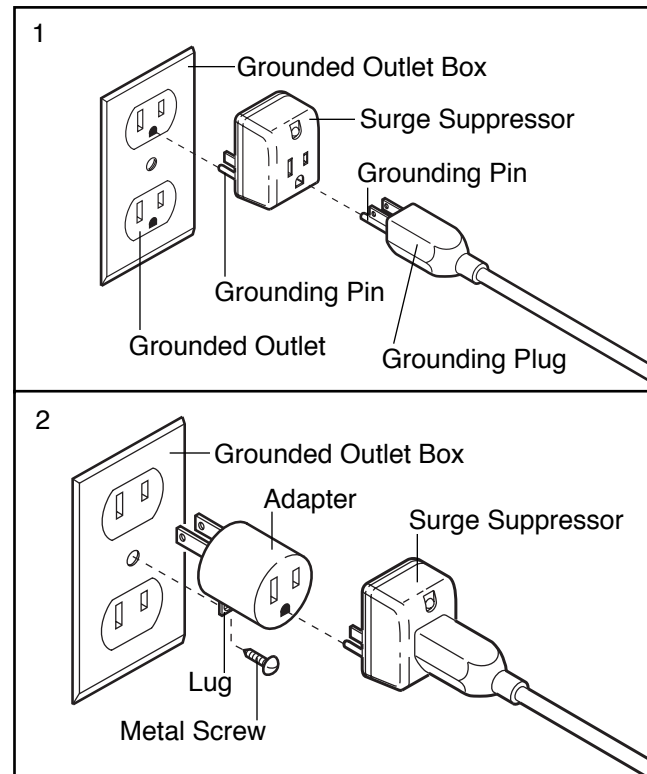

The temporary adapter should be used only until a properly grounded outlet (drawing 1) can be installed by a qualified electrician.

The green-colored rigid ear, lug, or the like extending from the adapter must be connected to a permanent ground such as a properly grounded outlet box cover. Whenever the adapter is used it must be held in place by a metal screw. **Some 2-pole receptacle outlet box covers are not grounded. Contact a qualified electrician to determine if the outlet box cover is grounded before using an adapter.**

## DIAGRAM OF THE CONSOLE

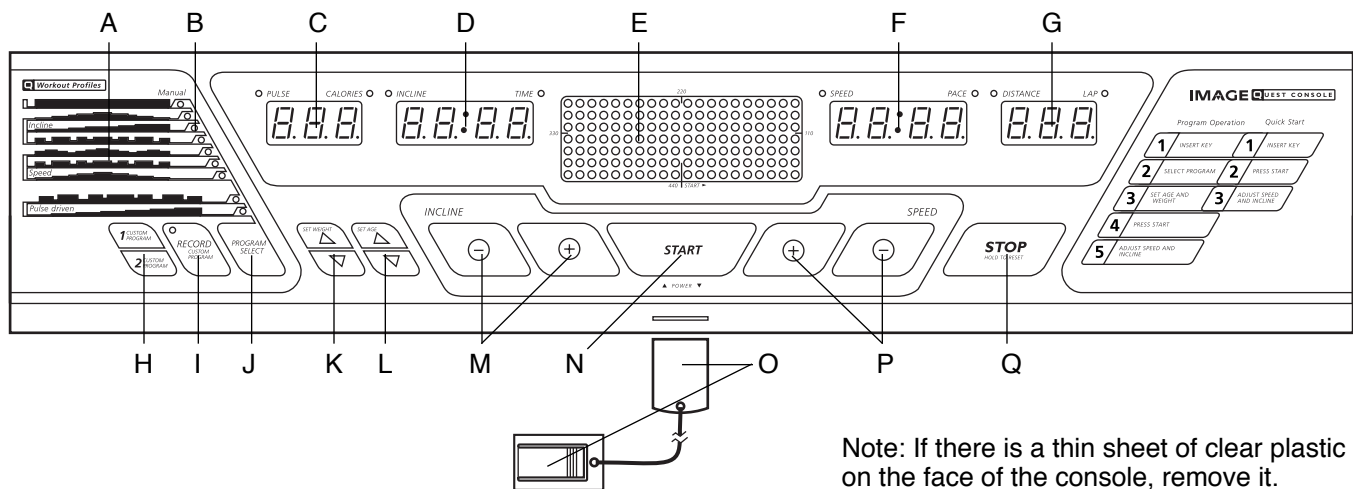

**CAUTION:** To reduce the risk of serious injury, read the following precautions before operating the console.

- Do not stand on the walking belt when turning on the power or starting the walking belt.
- Always wear the clip (see part “O” in the drawing above) while operating the treadmill. If the key is pulled from the console, the walking belt will stop.
- The treadmill is capable of high speeds. Adjust the speed in small increments.
- The heart rate monitor is not a medical device. Various factors may affect the accuracy of heart rate readings. The heart rate monitor is intended only as an exercise aid in determining heart rate trends in general.
- If you have heart problems, or if you are over 60 years of age and have been inactive, do not use the two pulse driven programs. If you are taking medication regularly, consult your physician to find whether the medication will affect your exercise heart rate.
- To reduce the risk of electric shock, keep the console dry, avoid spilling liquids on the console, and use only a sealed water bottle.

## FEATURES OF THE CONSOLE

The treadmill console offers an impressive array of features designed to make your workouts more effective.

When the console is in the manual mode, the speed and incline of the treadmill can be changed with a touch of a button. As you exercise, the console will display instant exercise feedback—you can watch your progress on the LED “track,” while the four displays show your heart rate, the number of calories burned, the incline, workout time, speed, pace, distance, and laps completed.

Eight preset programs are also offered: three incline programs automatically control the incline of the treadmill as they guide you through effective workouts; three speed programs automatically control the speed of the treadmill; and two pulse driven programs automatically control the speed and the incline of the treadmill to keep your heart rate within a predetermined range during your workouts.

The console also features two custom programs that allow you to create your own workout programs and store them in the console’s memory for future use.

**To use the manual mode**, follow the steps beginning on page 10. **To use an incline program or a speed program**, see page 12. **To use a pulse driven program**, see page 13. **To create a custom program**, see page 14. **To use a custom program**, see page 15.

Note: The console can display speed and distance in either miles or kilometers (see SPEED/PACE DISPLAY on page 11). For simplicity, all instructions in this section refer to miles.



## DIAGRAM OF THE CONSOLE

Refer to the drawing on the opposite page.

- A. Workout profiles—These profiles show how the incline of the treadmill will change during incline programs, how the speed will change during speed programs, and how your heart rate will change during pulse driven programs.
- B. Mode indicators—These indicators show whether the manual mode is selected or whether one of the eight preset programs is selected.
- C. PULSE/CALORIES display—This display shows both your heart rate (if the heart rate monitor is worn) and the approximate number of calories you have burned. The display will alternate between one number and the other every seven seconds. This display is also used to enter your weight into the console.
- D. INCLINE/TIME display—This display shows both the incline of the treadmill and the elapsed time. (If a preset program or a custom program is selected, the display will show the time remaining in the program.) The display will alternate between one number and the other every seven seconds. This display is also used to enter your age into the console.
- E. LED matrix—When the manual mode is selected, this matrix shows your progress on an LED track. When a preset program or a custom program is selected, the matrix shows the program's workout profile.
- F. SPEED/PACE display—This display shows both the speed of the walking belt and your current pace (minutes per mile). The display will alternate between one number and the other every seven seconds.
- G. DISTANCE/LAP display—This display shows both the distance you have walked and the number of laps you have completed (one lap equals 1/4 mile). The display will alternate between one number and the other every seven seconds.
- H. CUSTOM PROGRAM buttons—These buttons are used to select custom programs 1 and 2.
- I. RECORD button—This button is used to create custom programs.
- J. PROGRAM SELECT button—This button is used to select the manual mode and the eight preset programs. Note: If the walking belt is moving when the SELECT PROGRAM button is pressed, the walking belt will slow to a stop and the displays will be reset. In addition, the treadmill may automatically adjust to the lowest incline level.
- K. SET WEIGHT buttons—These buttons are used to enter your weight into the console.
- L. SET AGE buttons—These buttons are used to enter your age into the console.
- M. INCLINE buttons—These buttons are used to change the incline of the treadmill. The incline range is 0% to 12%. Note: The incline can be adjusted only while the walking belt is moving.
- N. START button—This button is used to start the walking belt when the manual mode, a preset program, or a custom program is selected.
- O. Key with clip—The key turns the console on and off. The clip is worn on the waistband of your clothes.
- P. SPEED buttons—These buttons control the speed of the walking belt. The speed range is 0.5 mph to 12 mph. Note: When the START button is pressed, the walking belt will begin to move at 1.0 mph.
- Q. STOP button—This button is used to pause or stop the walking belt when the manual mode, a preset program, or a custom program is selected.

## HOW TO TURN ON THE POWER

- 1** Plug in the power cord (see page 7). All displays and indicators on the console will flash once and then darken. Note: If the key is in the console when the power cord is plugged in, the letters "PO" will flash in the SPEED/PACE display. If this occurs, remove the key.

- 2** Make sure that the on/off switch located on the front of the treadmill is in the "on" position.

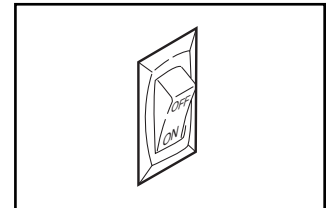

- 3** Stand on the foot rails of the treadmill and insert the key into the console. After a moment, the MANUAL indicator will light, the letters "LbS" will appear in the PULSE/CALORIES display, the letters "AGE" will appear in the INCLINE/TIME display, and the LED track in the center of the console will light. Every few seconds, the words "PRESS START" will scroll across the LED matrix.

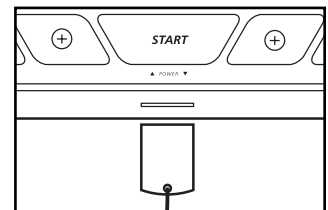

## HOW TO USE THE MANUAL MODE

### 1 Insert the key into the console.

See HOW TO TURN ON THE POWER on page 9. Note: When you are familiar with the operation of the console, you may go directly to step 5 if desired. The first time you use the console, please read and follow all steps.

### 2 Select the MANUAL mode.

When the key is inserted, the manual mode will automatically be selected and the MANUAL indicator will light. If a program has been selected, press the PROGRAM SELECT button repeatedly to select the manual mode again.

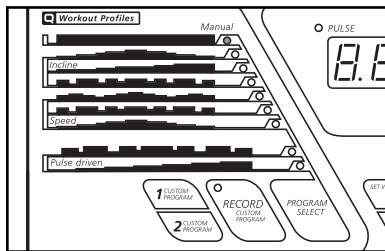

### 3 Enter your weight and age if desired.

Although it is not necessary to enter your weight and age to use the manual mode, the CALORIES display will be more accurate if these numbers are entered.

To enter your weight, press either of the SET WEIGHT buttons. The current weight setting will appear in the PULSE/CALORIES display. Press the SET WEIGHT buttons again to enter your weight. Each time one of the buttons is pressed, the weight setting will change by 1 pound. If one of the buttons is held down, the weight setting will change in increments of 5 pounds.



To enter your age, press either of the SET AGE buttons. The current age setting will appear in the INCLINE/TIME display. To enter your age, press the SET AGE buttons again. Each time one of the buttons is pressed, the age setting will change by 1 year. If one of the buttons is held down, the age setting will change in increments of 5 years. Note: Once you have entered your weight and age, the numbers will be saved in the console's memory, even if the power cord is unplugged.

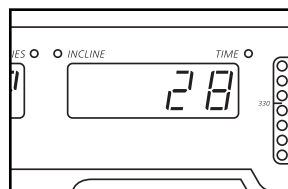

### 4 Put on the heart rate monitor if desired.

For the PULSE/CALORIES display to show your heart rate, the heart rate monitor must be worn. To put on the heart rate monitor, see HOW TO USE THE HEART RATE MONITOR on page 6.

### 5 Press the START button.

Press the START button to start the walking belt. The LED track in the center of the console will disappear in a counterclockwise direction. One flashing indicator will then re-appear and the walking belt will begin to move at 1.0 mph. Hold the handrails and step onto the walking belt.

The LED track represents 1/4 of a mile. As you exercise, the indicators will light one at a time until the entire track is lit.

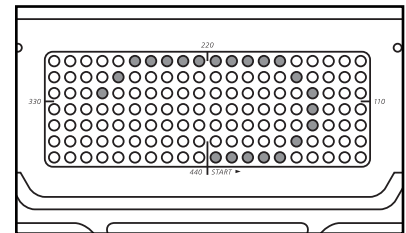

The track will then disappear in a counterclockwise direction and a new lap will begin.

To stop the walking belt momentarily, press the STOP button once. All displays will pause and the INCLINE/TIME display will begin to flash. To restart the walking belt, press the START button as described above. To stop the walking belt and reset all displays, hold down the STOP button for two seconds. The console will then be in the same state as if the key had just been inserted.

### 6 Adjust the incline and speed of the treadmill.

While the walking belt is moving, the incline of the treadmill can be adjusted with the INCLINE buttons. Each time one of the buttons is pressed, the incline will change by 0.5%. The buttons can be held down to change the incline quickly. The incline range is 0% to 12%. Note: After the buttons are pressed, it may take a moment for the treadmill to reach the selected incline setting.

To adjust the speed of the walking belt, press the SPEED buttons. Each time one of the buttons is pressed, the speed will change by 0.1 mph. The buttons can be held down to change the speed in increments of 0.5 mph. The speed range of the walking belt is 0.5 mph to 12.0 mph.

## 7 Follow your progress with the four displays.

**PULSE/CALORIES display**—This display shows both your heart rate (if the heart rate monitor is worn) and the approximate number of calories you have burned. The display will alternate between one number and the other every seven seconds.

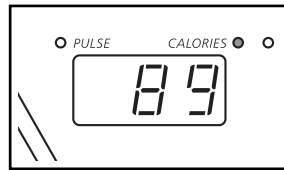

Note: The heart rate monitor will sample your heart rate every few seconds; it may take up to ten seconds before an accurate heart rate is shown. If your heart rate is not shown, see HEART RATE MONITOR TROUBLE-SHOOTING on page 6.

### INCLINE/TIME

**display**—This display shows both the incline of the treadmill and the elapsed time. (If a preset program or a custom program is selected, the display will show the time remaining in the program.) The display will alternate between one number and the other every seven seconds.

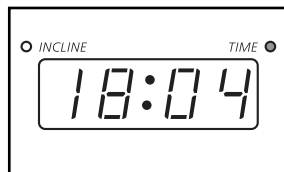

Note: Each time the INCLINE buttons are pressed, the display will show the incline setting.

### SPEED/PACE

**display**—This display shows both the speed of the walking belt and your current pace (minutes per mile). The display will alternate between one number and the other every seven seconds.



Note: Each time the SPEED buttons are pressed, the display will show the speed setting.

Note: The speed can be displayed in either miles per hour (mph) or kilometers per hour (kph). To check the unit of measurement, first hold down the STOP button while inserting the key into the console. The SPEED/PACE display will show an "E" for "English" (miles) or an "M" for "Metric" (kilometers). Press the SPEED "+" button to change the unit of measurement. Remove and then reinsert the key.

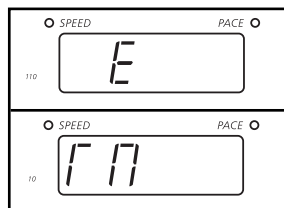

### DISTANCE/LAP display

—This display shows both the distance you have walked and the number of laps you have completed (one lap equals 1/4 mile). The display will alternate between one number and the other every seven seconds.

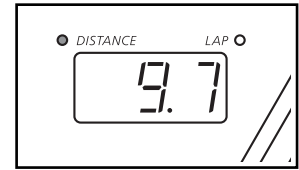

Note: If the speed is displayed in miles per hour, the distance will be displayed in miles; if the speed is displayed in kilometers per hour, the distance will be displayed in kilometers.

## 8 When you are finished exercising, stop the walking belt and remove the key.

Step onto the foot rails, press the STOP button, and remove the key from the console. Store the key in a secure place. In addition, press the on/off switch to the "off" position. (See the drawing near the bottom of page 9.)

## HOW TO USE THE INCLINE PROGRAMS AND THE SPEED PROGRAMS

### 1 Insert the key into the console.

See HOW TO TURN ON THE POWER on page 9.

### 2 Select one of the incline or speed programs.

When the key is inserted, the manual mode will automatically be selected and the MANUAL indicator will light.

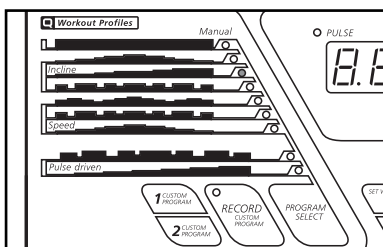

To select one of the incline or speed programs, press the PROGRAM SELECT button repeatedly until the desired INCLINE or SPEED indicator lights. Note: The first incline program and the first speed program are twenty-minute programs. All other preset programs are thirty-minute programs.

When an incline or speed program is selected, the LED matrix will show all of the incline or speed settings of the program.

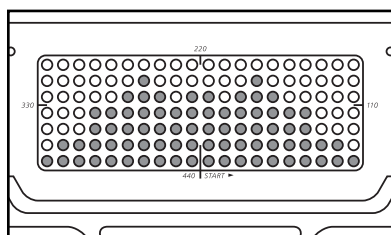

Each incline program has twenty incline settings, and each speed program has twenty speed settings. One setting is shown in each vertical column of the LED matrix. The first column will be flashing. Note: Every few seconds, the words "PRESS START" will scroll across the LED matrix.

### 3 Enter your weight and age if desired.

Although it is not necessary to enter your weight and age to use an incline program or a speed program, the CALORIES display will be more accurate if these numbers are entered.

To enter your weight and age, refer to step 3 on page 10. If you have already entered your weight and age, or if you do not want to enter this information, go to step 4.

### 4 Put on the heart rate monitor if desired.

For the PULSE/CALORIES display to show your heart rate, the heart rate monitor must be worn. To put on the heart rate monitor, see HOW TO USE THE HEART RATE MONITOR on page 6.

### 5 Press the START button.

Press the START button to start the program. After a moment, the walking belt will begin to move. Hold the handrails and begin walking.

**If an incline program is selected:** When the START button is pressed, the walking belt will begin to move at 1.0 mph and the incline will adjust to the incline setting shown in the first column of the LED matrix. After one minute (or 90 seconds if a thirty-minute program is selected), the second column of the LED matrix will begin to flash and the incline will adjust to the incline setting shown in the second column. After another minute (or 90 seconds), the third column will begin to flash and the incline will adjust to the setting shown in the third column. The program will continue in this way until the twentieth column is flashing and no time remains in the TIME display. The walking belt will then slow to a stop.

The speed of the walking belt can be adjusted during the incline program with the SPEED buttons. To stop the program momentarily, press the STOP button once. All displays will pause and the INCLINE/TIME display will begin to flash. To restart the program, press the START button. To end the program before it is completed, hold down the STOP button for two seconds. The console will then be in the same state as if the key had just been inserted.

While the incline program is in progress, the difficulty level of the program can be adjusted, if desired, with the INCLINE buttons. Press the INCLINE "+" button once. The letters "MAX" will appear in the LED matrix, and the INCLINE/TIME display will show the maximum incline that the treadmill will reach during the program. This information will be displayed for three seconds. Press the INCLINE "+" button again. Each time the button is pressed, the maximum incline setting and all other settings of the program will increase slightly. The INCLINE "-" button can be used in the same way to decrease the difficulty level of the program. Note: The profile shown in the LED matrix will not change; the profile shows relative incline settings.

**If a speed program is selected:** When the START button is pressed, the walking belt will begin to move at 1.0 mph, the speed setting shown in the first column of the LED matrix. After one minute (or 90 seconds if a thirty-minute program is selected), the second column of the LED matrix will begin to flash and the speed will adjust to the speed setting shown in the second column. After another minute (or 90 seconds), the third column will begin to flash and the speed will adjust to the setting shown in the third column. The program will continue in this way until the twentieth column is flashing and no time remains in the TIME display. The walking belt will then slow to a stop.

The incline of the treadmill can be adjusted during the speed program with the INCLINE buttons. To stop the program momentarily, press the STOP button once. All displays will pause and the INCLINE/TIME display will begin to flash. To restart the program, press the START button. To end the program before it is completed, hold down the STOP button for two seconds. The console will then be in the same state as if the key had just been inserted.

While the speed program is in progress, the difficulty level of the program can be adjusted, if desired, with the SPEED buttons. Press the SPEED “+” button once. The letters “MAX” will appear in the LED matrix, and the SPEED/PACE display will show the maximum speed that the treadmill will reach during the program. This information will be displayed for three seconds. Press the SPEED “+” button again. Each time the button is pressed, the maximum speed setting and all other settings of the program will increase slightly. The SPEED “-” button can be used in the same way to decrease the difficulty level of the program. Note: The profile shown in the LED matrix will not change; the profile shows relative speed settings.

## 6 Follow your progress with the LED displays.

Refer to step 7 on page 11.

## 7 Remove the key from the console.

When the program has ended, remove the key from the console. All displays and indicators on the console will darken.

## HOW TO USE THE PULSE DRIVEN PROGRAMS

### 1 Insert the key into the console.

See HOW TO TURN ON THE POWER on page 9.

### 2 Select one of the pulse driven programs.

When the key is inserted, the manual mode will automatically be selected and the MANUAL indicator will light.

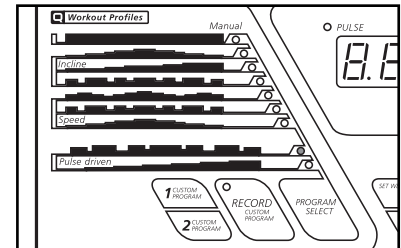

To select one of the pulse driven programs, press the PROGRAM SELECT button repeatedly until the desired PULSE DRIVEN indicator lights. Note: Both pulse driven programs are thirty-minute programs.

The pulse driven programs automatically control the speed and incline of the treadmill to keep your

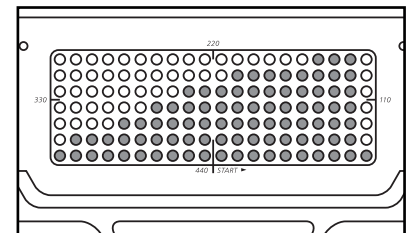

heart rate near predetermined settings during your workout. When one of the pulse driven programs is selected, the LED matrix will show all of the heart rate settings of the program. Each program has twenty heart rate settings. One setting is shown in each vertical column of the LED matrix. The first column will be flashing. Note: Every few seconds, the words “ENTER AGE” will scroll across the LED matrix.

### 3 Enter your weight and age.

Although it is not necessary to enter your weight to use a pulse driven program, **you must enter your age before one of these programs can be started.**

To enter you weight and age, refer to step 3 on page 10. **If you have already entered your weight and age, press either of the SET AGE buttons to verify the age setting.** The words “PRESS START” will then scroll across the LED matrix every few seconds.

#### **4 Put on the heart rate monitor.**

The heart rate monitor must be worn when a pulse driven program is used. See HOW TO USE THE HEART RATE MONITOR on page 6. Note: A pulse driven program can be started without a heart rate reading; however, the speed and/or incline of the treadmill will automatically decrease if your heart rate is not detected during the program.

#### **5 Press the START button.**

Press the START button to start the program. After a moment, the walking belt will begin to move. Hold the handrails and begin walking.

While the first column of the LED matrix is flashing, the walking belt will move at 1.5 mph. After 90 seconds, the second column of the LED matrix will begin to flash. As the program progresses, the speed and/or incline of the treadmill will change at any time to keep your heart rate near the heart rate setting shown in the flashing column. When the twentieth column begins to flash, the walking belt will move at 1.5 mph until no time remains in the TIME display. The walking belt will then slow to a stop and the program will be completed.

If your heart rate is not detected during the program, the letters "PLS" will flash in the PULSE/CALORIES display and the speed and/or incline of the treadmill will automatically decrease. See HEART RATE MONITOR TROUBLE-SHOOTING on page 6.

While the program is in progress, minor adjustments can be made to the speed or incline of the treadmill with the SPEED or INCLINE buttons. However, if you increase the speed, the incline will automatically decrease; if you decrease the speed, the incline will increase. If you increase the incline, the speed will decrease; if you decrease the incline, the speed will increase. The console will always attempt to keep your heart rate near the heart rate setting shown in the flashing column. Note: When the incline reaches the lowest setting, the speed cannot be increased any further. When the incline reaches the highest setting, the speed cannot be decreased any further.

#### **6 Follow your progress with the LED displays.**

Refer to step 7 on page 11.

#### **7 Remove the key from the console.**

When the program has ended, remove the key from the console. All displays and indicators on the console will darken.

### HOW TO CREATE A CUSTOM PROGRAM

#### **1 Insert the key into the console.**

See HOW TO TURN ON THE POWER on page 9.

#### **2 Select one of the custom programs.**

To select one of the custom programs, press the CUSTOM PROGRAM 1 or CUSTOM PROGRAM 2 button. The letters "CP 1" or "CP 2" will appear in the SPEED/PACE display to show which program you have selected.

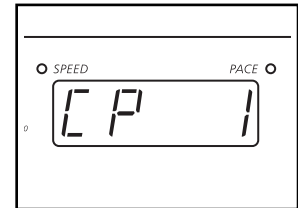

Custom programs are workout programs that you create. The programs are stored in the console's memory, and can be changed as many times as desired. Custom programs control both the speed and the incline of the treadmill. When one of the custom programs is selected, the LED matrix will show the speed settings of the program (until you have created a program, all speed settings will be the same). The first column will be flashing. Note: Every few seconds, the words "PRESS START" will scroll across the LED matrix.

#### **3 Enter your weight and age if desired.**

It is not necessary to enter your weight and age to create a custom program; however, the CALORIES display will be more accurate if these numbers are entered.

To enter your weight and age, refer to step 3 on page 10. If you have already entered your weight and age, or if you do not want to enter this information, go to step 4.

#### **4 Press the START button.**

Press the START button to start the program. After a moment, the walking belt will begin to move. Hold the handrails and begin walking.

## 5 Press the RECORD button and program the desired speed and incline settings.

When the RECORD button is pressed, the indicator on the button will light. **Speed and incline settings can be programmed only when the indicator on the button is lit.**

Refer to the LED matrix. Each custom program is divided into one-minute segments. One speed setting and one incline

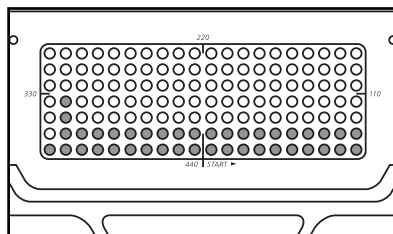

setting can be programmed for each one-minute segment. The speed setting of the first segment is shown in the flashing column of the LED matrix. (The incline settings are not shown in the LED matrix.) To program the desired speed and incline settings for the first segment, simply adjust the speed and incline of the treadmill to the desired levels with the SPEED and INCLINE buttons. Every few times the SPEED "+" or "-" button is pressed, an additional LED will light or darken in the flashing column.

When the first one-minute segment of the program is completed, the current speed setting and the current incline setting will be stored in memory. All columns in the LED matrix will then move one position to the left, and the speed setting of the second segment will be shown in the flashing column. Program speed and incline settings for the second segment as described above.

Repeat this procedure until you have programmed speed and incline settings for as many segments as desired. Custom programs can have from one to forty segments. When you are finished, hold down the STOP button for two seconds. The speed and incline settings you programmed and the number of segments will then be stored in memory. To use the program again, see HOW TO USE A CUSTOM PROGRAM at the right.

Note: To pause the program temporarily while you are programming speed and incline settings, press the STOP button once. All displays will pause and the TIME display will begin to flash. To restart the program, press the START button.

## 6 Remove the key from the console.

When the program has ended, remove the key from the console. All displays and indicators on the console will darken.

## HOW TO USE A CUSTOM PROGRAM

### 1 Insert the key into the console.

See HOW TO TURN ON THE POWER on page 9.

### 2 Select one of the custom programs.

To select one of the custom programs, press the CUSTOM PROGRAM 1 or CUSTOM PROGRAM 2 button. The letters "CP 1" or "CP 2" will appear in the SPEED/PACE display to show which program is selected.

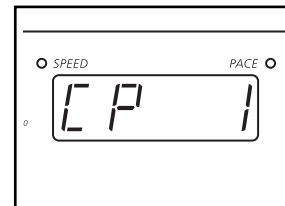

When a custom program is selected, the LED matrix will show the speed settings of the program. If the program is more than twenty minutes long, only the first nineteen settings will be shown. The first column will be flashing. Note: Every few seconds, the words "PRESS START" will scroll across the LED matrix.

### 3 Enter your weight and age if desired.

It is not necessary to enter your weight and age to use a custom program; however, the CALORIES display will be more accurate if these numbers are entered.

To enter your weight and age, refer to step 3 on page 10. If you have already entered your weight and age, or if you do not want to enter this information, go to step 4.

### 4 Press the START button.

Press the START button to start the program. After a moment, the walking belt will begin to move. Hold the handrails and begin walking.

Refer to the LED matrix. Each custom program is divided into one-minute segments. One speed setting and one in-

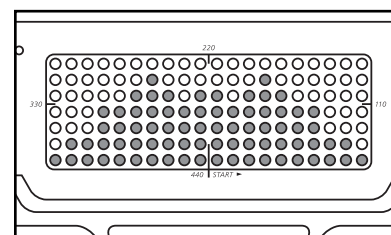

cline setting are programmed for each segment. The speed setting of the first segment is shown in the flashing column of the LED matrix. The speed settings of the next six segments are shown in the six columns to the right. (The incline settings are not shown in the program display.)

When the first one-minute segment of the program is completed, all columns of the LED matrix will move one position to the left, the speed setting of the second segment will be shown in the flashing column, and the speed of the treadmill will change accordingly. The incline will also change according to the settings that you programmed previously.

The program will continue in this way until the speed setting of the last segment is shown in the flashing column and no time remains in the TIME display. The walking belt will then slow to a stop.

Note: If the program is too easy or too difficult, the speed or incline setting of the current segment can be adjusted with the SPEED or INCLINE buttons. Adjustments will not be stored in memory. To **reprogram** the speed or incline setting of the current segment, press the RECORD button. The indicator on the button will light. **Speed and incline settings can be programmed only when the indicator on the button is lit.** Adjust the speed or incline setting of the current segment with the SPEED or INCLINE buttons. After the segment is completed, press the RECORD button again. The new setting will then be stored in memory.

To stop the program momentarily, press the STOP button once. All displays will pause and the INCLINE/TIME display will begin to flash. To restart the program, press the START button. To end the program before it is completed, hold down the STOP button for two seconds. The console will then be in the same state as if the key had just been inserted.

## **5 Follow your progress with the LED displays.**

Refer to step 7 on page 11.

## **6 Remove the key from the console.**

When the program has ended, remove the key from the console. All displays and indicators on the console will darken.

## **HOW TO SELECT THE INFORMATION MODE**

The console features an information mode that keeps track of the total time and distance accumulated on the treadmill.

To access the information mode, hold down the STOP button while inserting the key into the console. The INCLINE/TIME display will show the total number of hours accumulated on the treadmill. The DISTANCE/LAP display will show the number of miles accumulated (if the total number of miles exceeds 999, the thousands and ten thousands digits will be shown in the right half of the SPEED/PACE display). The left half of the SPEED/PACE display will show which unit of measurement is currently selected: an "E" for "English" (miles) or an "M" for "Metric" (kilometers). To change the unit of measurement, press the SPEED "+" button.

To exit the information mode, remove the key from the console.

## **HOW TO ADJUST THE CUSHION LEVEL OF THE TREADMILL**

The treadmill is specially designed to cushion the impact as you walk or run. The cushion level is controlled with the knob on the right side of the treadmill. For a softer cushion level, turn the knob counterclockwise. For a firmer cushion level, turn the knob clockwise. Note: The faster you run on the treadmill, the firmer the cushion level should be. If the cushion level is too soft, the treadmill may bounce excessively.

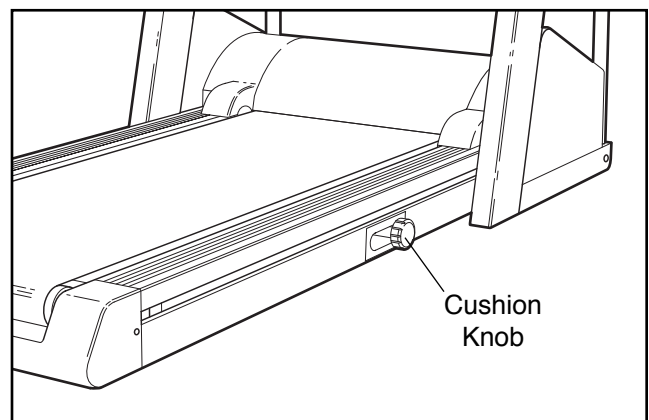



# HOW TO FOLD AND MOVE THE TREADMILL

## HOW TO FOLD THE TREADMILL FOR STORAGE

Before folding the treadmill, unplug the power cord. **Caution: You must be able to safely lift 45 pounds (20 kg) in order to raise, lower, or move the treadmill.**

1. Hold the treadmill with your hands in the locations shown at the right. **To decrease the possibility of injury, bend your legs and keep your back straight. As you raise the treadmill, make sure to lift with your legs rather than your back.** Raise the treadmill about halfway to the vertical position.
2. Move your right hand to the position shown and hold the treadmill firmly. Hold the lock knob with your left hand and pull it to the side. Raise the treadmill until the lock knob is aligned with the catch. Slowly release the knob. **Make sure that the pin on the lock knob is inside of the catch.**

**To protect the floor or carpet from damage, place a mat under the treadmill. Keep the treadmill out of direct sunlight. Do not leave the treadmill in the storage position in temperatures above 85° Fahrenheit.**

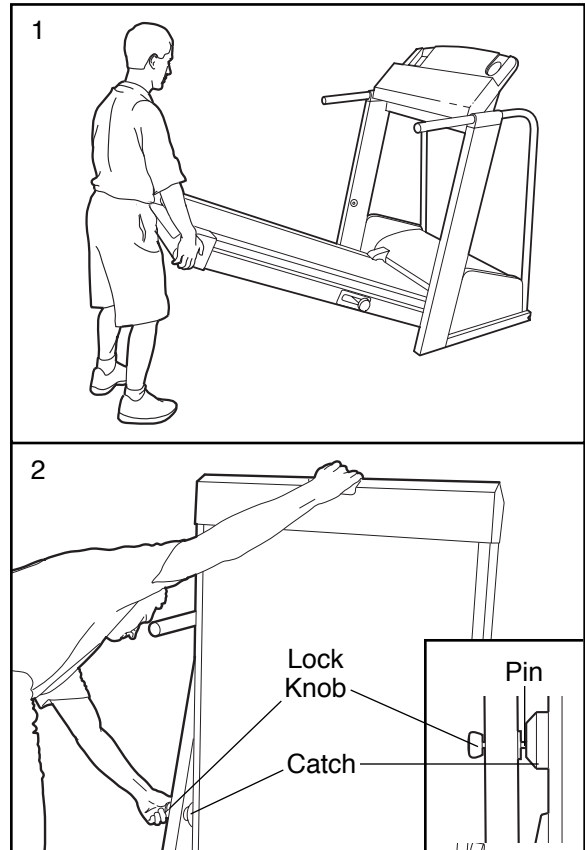

## HOW TO MOVE THE TREADMILL

Before moving the treadmill, convert the treadmill to the storage position as described above. **Make sure that the pin on the lock knob is inside of the catch.**

1. Hold the handrails and place one foot on the base as shown.
2. Tilt the treadmill back until it rolls freely on the front wheels. Carefully move the treadmill to the desired location. **Never move the treadmill without tipping it back. To reduce the risk of injury, use extreme caution while moving the treadmill. Do not move the treadmill over an uneven surface.**
3. Place one foot on the base and carefully lower the treadmill until it is resting on the base.

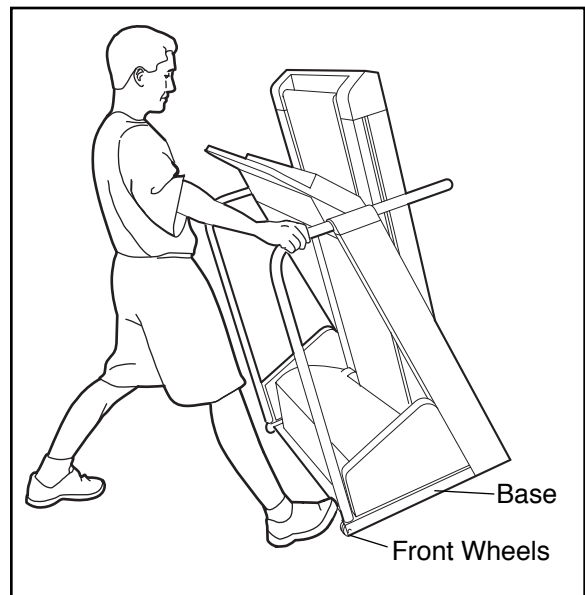

## HOW TO LOWER THE TREADMILL FOR USE

1. Refer to drawing 2 above. Hold the upper end of the treadmill with your right hand as shown. Hold the lock knob with your left hand and pull it to the side. Pivot the treadmill down a few inches.
2. Refer to drawing 1 above. Hold the treadmill firmly with both hands, and lower the treadmill to the floor. **To decrease the possibility of injury, bend your legs and keep your back straight.**

# MAINTENANCE AND TROUBLE-SHOOTING

Most treadmill problems can be solved by following the simple steps below. If further assistance is needed, call our toll-free HELPLINE at 1-800-736-6879, Monday through Saturday, 7 a.m. until 7 p.m. Central Time (excluding holidays).

**PROBLEM: The power does not turn on**

**SOLUTION:** a. Make sure that the power cord is plugged into a surge suppressor, and that the surge suppressor is plugged into a properly grounded outlet (see page 7). Use only a single-outlet surge suppressor that is UL 1449 listed as a transient voltage surge suppressor (TVSS). The surge suppressor must have a UL suppressed voltage rating of 400 volts or less and a minimum surge dissipation of 450 joules. The surge suppressor must be electrically rated for 120 volts AC and 15 amps.

b. After the power cord has been plugged in, make sure that the key is fully inserted into the console. (See step 3 on page 9.)

c. Check the circuit breaker located on the treadmill near the power cord. If the switch protrudes as shown, the circuit breaker has tripped. To reset the circuit breaker, wait for five minutes and then press the switch back in.

d. Check the on/off switch located at the front of the treadmill near the power cord. The switch must be in the "on" position.

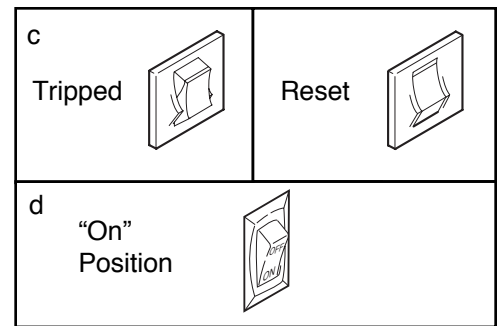

**PROBLEM: The power turns off during use**

**SOLUTION:** a. Check the circuit breaker located on the treadmill frame near the power cord (see 1. c. above). If the circuit breaker has tripped, wait for five minutes and then press the switch back in.

b. Make sure that the power cord is plugged in.

c. Remove the key from the console. Reinsert the key fully into the console. (See step 3 on page 9.)

d. Make sure that the on/off switch is in the "on" position. (See 1. d. above.)

e. If the treadmill still will not run, please call our toll-free HELPLINE.

**PROBLEM: The walking belt slows when walked on**

**SOLUTION:** a. Use only a single-outlet surge suppressor that is UL 1449 listed as a transient voltage surge suppressor (TVSS). The surge suppressor must have a UL suppressed voltage rating of 400 volts or less and a minimum surge dissipation of 450 joules. The surge suppressor must be electrically rated for 120 volts AC and 15 amps.

b. If the walking belt still slows when walked on, please call our toll-free HELPLINE.

**PROBLEM: The walking belt is off-center when walked on**

a. If the walking belt has shifted to the left, first remove the key and **UNPLUG THE POWER CORD**. Using the allen wrench, turn the left rear roller adjustment bolt clockwise, and the right bolt counterclockwise, 1/4 of a turn each. Be careful not to overtighten the walking belt. Plug in the power cord, insert the key and run the treadmill for a few minutes. Repeat until the walking belt is centered.

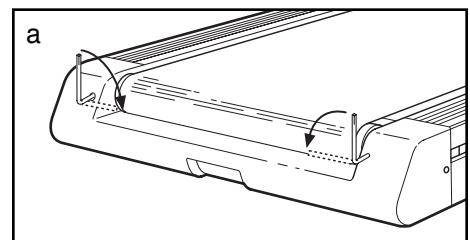

- b. If the walking belt has shifted to the right, first remove the key and **UNPLUG THE POWER CORD**. Using the allen wrench, turn the left rear roller adjustment bolt counterclockwise, and the right bolt clockwise, 1/4 of a turn each. Be careful not to overtighten the walking belt. Plug in the power cord, insert the key and run the treadmill for a few minutes. Repeat until the walking belt is centered.

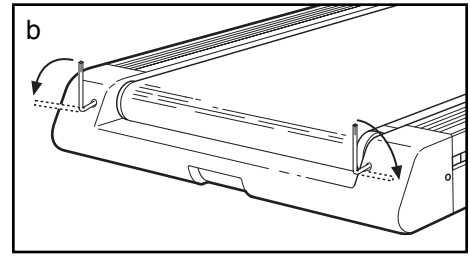

- c. If the walking belt slips when walked on, first remove the key and **UNPLUG THE POWER CORD**. Using the allen wrench, turn both rear roller adjustment bolts clockwise, 1/4 of a turn. When the walking belt is correctly tightened, you should be able to lift each side of the walking belt 3 to 4 inches off the walking platform. Be careful to keep the walking belt centered. Plug in the power cord, insert the key and carefully walk on the treadmill for a few minutes. Repeat until the walking belt is properly tightened.

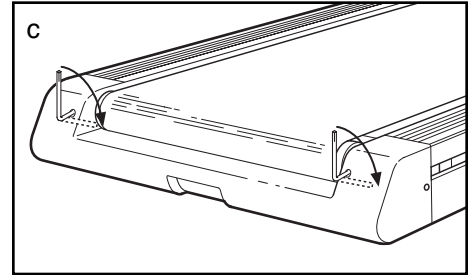

**PROBLEM: The heart rate monitor does not function properly**

- a. If the heart rate monitor does not function properly, refer to HEART RATE MONITOR TROUBLESHOOTING on page 6.
- b. **The CR 2032 battery may need to be replaced.**

If the heart rate monitor still does not function properly, the battery should be changed. To replace the battery, locate the battery cover on the back of the sensor unit. Insert a coin into the slot in the cover and turn the cover counterclockwise to the "open" position. Remove the cover.

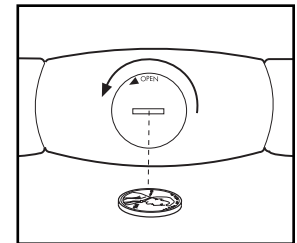

Remove the old battery from the sensor unit. Insert a new CR 2032 battery, making sure that the writing is on top. In addition, make sure that the rubber gasket is in place in the sensor unit. Replace the battery cover and turn it to the closed position.

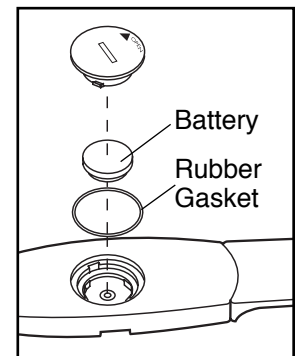

**PROBLEM: An error code (E1, E20, E21, E22, E23, OR E24) appears on the console**

- a. If an error code appears, remove the key from the console, wait for a moment, and then reinsert it. If the error code appears again, call our Customer Service Department. Do not use the treadmill until the problem is corrected.

# CONDITIONING GUIDELINES

**⚠ WARNING:** Before beginning this or any exercise program, consult your physician. This is especially important for individuals over the age of 35 or individuals with pre-existing health problems.

The following guidelines will help you to plan your exercise program. Remember—these are general guidelines. For more detailed information about exercise, obtain a book or consult your physician.

## EXERCISE INTENSITY

Whether your goal is to burn fat or strengthen your cardiovascular system, the key to achieving the desired results is to exercise with the proper intensity. The proper intensity level can be found by using your heart rate as a guide. For effective exercise, your heart rate should be maintained at a level between 70% and 85% of your maximum heart rate as you exercise. This is known as your training zone.

You can find your training zone in the table below. Training zones are listed according to age and physical condition.

Age	Training Zone (Beats/Min.)	
	Unconditioned	Conditioned
20	138-167	133-162
25	136-166	132-160
30	135-164	130-158
35	134-162	129-156
40	132-161	127-155
45	131-159	125-153
50	129-156	124-150
55	127-155	122-149
60	126-153	121-147
65	125-151	119-145
70	123-150	118-144
75	122-147	117-142
80	120-146	115-140
85	118-144	114-139

## Burning Fat

To burn fat, you must exercise at a low intensity level for a sustained period of time. During the first few minutes of exercise, your body uses easily accessible carbohydrate calories for energy. Only after the first few minutes of exercise does your body begin to use stored fat calories for energy. If your goal is to burn fat, adjust the intensity of your exercise until your heart rate is near the low end of your training zone as you exercise.

**⚠ WARNING:** The heart rate monitor is not a medical device. Various factors, including your movement, may affect the accuracy of heart rate readings. The heart rate monitor is intended only as an exercise aid in determining heart rate trends in general.

## Aerobic Exercise

If your goal is to strengthen your cardiovascular system, your exercise must be “aerobic.” Aerobic exercise is activity that requires large amounts of oxygen for prolonged periods of time. This increases the demand on the heart to pump blood to the muscles, and on the lungs to oxygenate the blood. For aerobic exercise, adjust the intensity of your exercise until your heart rate is near the middle of your training zone.

## WORKOUT GUIDELINES

Each workout should include the following three important parts: (1) a warm-up, (2) training zone exercise, and (3) a cool-down.

### Warm-up

Warming up prepares the body for exercise by increasing circulation, delivering more oxygen to the muscles, and raising the body temperature. Begin each workout with 5 to 10 minutes of stretching and light exercise to warm up (see SUGGESTED STRETCHES on page 21).

### Training Zone Exercise

After warming up, increase the intensity of your exercise until your heart rate is in your training zone for 20 to 60 minutes. (During the first few weeks of your exercise program, do not keep your heart rate in your training zone for longer than 20 minutes.) Breathe regularly and deeply as you exercise—never hold your breath.

## Cool-down

Finish each workout with 5 to 10 minutes of stretching to cool down. This will increase the flexibility of your muscles and will help to prevent post-exercise problems.

## Exercise Frequency

To maintain or improve your condition, complete three workouts each week, with at least one day of rest be-

tween workouts. After a few months, you may complete up to five workouts each week if desired.

The key to success is to make exercise a regular and enjoyable part of your everyday life.

## SUGGESTED STRETCHES

The correct form for several basic stretches is shown at the right. Move slowly as you stretch—never bounce.

### 1. Toe Touch Stretch

Stand with your knees bent slightly and slowly bend forward from your hips. Allow your back and shoulders to relax as you reach down toward your toes as far as possible. Hold for 15 counts, then relax. Repeat 3 times. Stretches: Hamstrings, back of knees and back.

### 2. Hamstring Stretch

Sit with one leg extended. Bring the sole of the opposite foot toward you and rest it against the inner thigh of your extended leg. Reach toward your toes as far as possible. Hold for 15 counts, then relax. Repeat 3 times for each leg. Stretches: Hamstrings, lower back and groin.

### 3. Calf/Achilles Stretch

With one leg in front of the other, reach forward and place your hands against a wall. Keep your back leg straight and your back foot flat on the floor. Bend your front leg, lean forward and move your hips toward the wall. Hold for 15 counts, then relax. Repeat 3 times for each leg. To cause further stretching of the achilles tendons, bend your back leg as well. Stretches: Calves, achilles tendons and ankles.

### 4. Quadriceps Stretch

With one hand against a wall for balance, reach back and grasp one foot with your other hand. Bring your heel as close to your buttocks as possible. Hold for 15 counts, then relax. Repeat 3 times for each leg. Stretches: Quadriceps and hip muscles.

### 5. Inner Thigh Stretch

Sit with the soles of your feet together and your knees outward. Pull your feet toward your groin area as far as possible. Hold for 15 counts, then relax. Repeat 3 times. Stretches: Quadriceps and hip muscles.

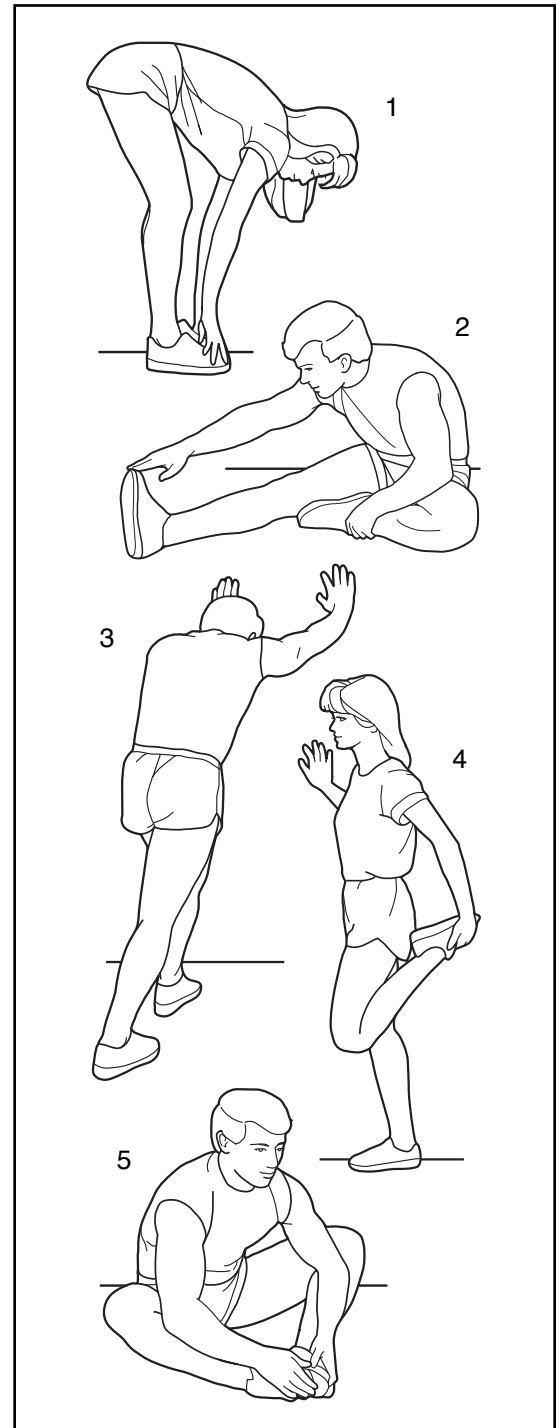

# PART LIST—Model No. 831.297572

R1098A

Note: To identify the parts listed below, refer to the EXPLODED DRAWING attached at the center of this manual.

Key No.	Qty.	Description	Key No.	Qty.	Description
1	1	Frame	53	2	Sensor Wire
2	34	Screw	54	2	Shock
3	5	Isolator Nut	55	1	Walking Belt
4	4	Spring Bolt	56	8	Belly Pan Spacer
5	2	Cushion Spring	57	5	Motor Pivot Nut
6	2	Isolator	58	1	Cushion Shaft
7	2	Cushion Adj. Rack	59	1	Belly Pan
8	8	Rack Screw	60	1	Right Foot Rail
9	2	Cushion Adj. Gear	61	5	8" Cable Tie
10*	1	Motor/Pulley/Flywheel/Fan	62	1	Motor Bracket
11	1	Latch Housing	63	1	Tie Holder
12	1	Left Foot Rail	64	1	Releasable tie
13	2	Rear Platform Screw	65	2	Short Rear Roller Adj. Bolt
14	2	Roller Guard	66	1	Rear Roller Endcap
15	1	Walking Platform	67	2	Endcap Pad
16	1	Rear Roller	68	1	Pulse Monitor
17	4	Incline Pivot Bolt/Incline Motor Nut	69	1	Monitor Strap
18	1	Front Roller/Pulley	70	1	Console
19	4	Motor Bolt	71	19	Upright Cap Screw
20	1	Console Base	72	1	Motor
21	5	Bracket Screw	73	4	Upright Cap
22	2	Hood Anchor	74	8	Console Screw
23	2	Hood Anchor Bracket	75	1	Console Plate
24	3	Motor Bracket Bolt	76	1	Pulley/Flywheel/Fan
25	3	Motor Bracket Washer	77	1	Hood
26	3	Long Hood Bracket	78	5	Hood Screw
27	2	Belt Guide	79	1	Cushion Knob
28	2	Motor Tension Bolt	80	1	Power Board
29	1	Outlet Bracket	81	4	Plastic Stand-Off
30	1	Circuit Breaker	82	1	Set Screw
31	1	Power Cord	83	1	Controller
32	1	Power Cord Grommet	84	1	Upright Wire Harness
33	1	On/Off Switch	85	2	Isolator Bolt
34	1	Incline Leg	86	1	Electronics Plate
35	1	Front Roller Adj. Bolt	87	1	Upright Cover (right inside)
36	9	Roller Adj. Washer	88	2	Upright Cover
37	2	Incline Leg Spacer	89	2	Platform Screw (front)
38	3	Incline Leg Pivot Nut	90	2	Wheel Bolt
39	4	Motor Nut	91	4	Front Wheel
40	1	Motor Pivot Bolt	92	1	8" Ground Wire
41	2	Roll Pin	93	9	Wheel Nut
42	1	Key/Clip	94	1	Adhesive Clip
43	2	Flange Nut	95	1	Allen Wrench
44	2	Motor Tension Washer	96	2	Upright Cap
45	2	Small Nut	97	2	Handrail Foam
46	1	4" Wire Tie	98	2	Handrail Endcap
47	2	Small Bolt	99	1	Lock Knob
48	2	Sensor	100	1	Lock Knob Sleeve
49	1	Speed Sensor Bracket	101	1	Lock Knob Spring
50	1	Speed Disk	102	1	Lock Pin Collar
51	1	Motor Belt	103	1	Lock Pin
52	1	Warning Decal	104	1	Pin Clip

Key No.	Qty.	Description	Key No.	Qty.	Description
105	2	Platform Washer	117	1	Console Wire Harness
106	1	Stop Bracket	118	1	Battery Cover
107	2	Incline Decal	119	2	Spring Spacer
108	2	Small Star Washer	#	1	14" White Wire, 2 Female
109	1	Incline Disk	#	1	14" White Wire, Male/Female
110	2	Console Bracket Screw	#	1	14" Blue Wire, 2 Female
111	1	Incline Motor	#	1	8" Blue Wire, 2 Female
112	1	I-Bolt	#	1	9" Black Wire, Male/Female
113	1	Receiver	#	1	8" Red Wire, Male/Female
114	1	Belly Pan Hinge	#	1	User's Manual
115	1	Upright/Base	* Includes all parts shown in the box		
116	1	Upright Cover (left outside)	# These parts are not illustrated		

# EXPLODED DRAWING — Model No. 831.297572

R1098A

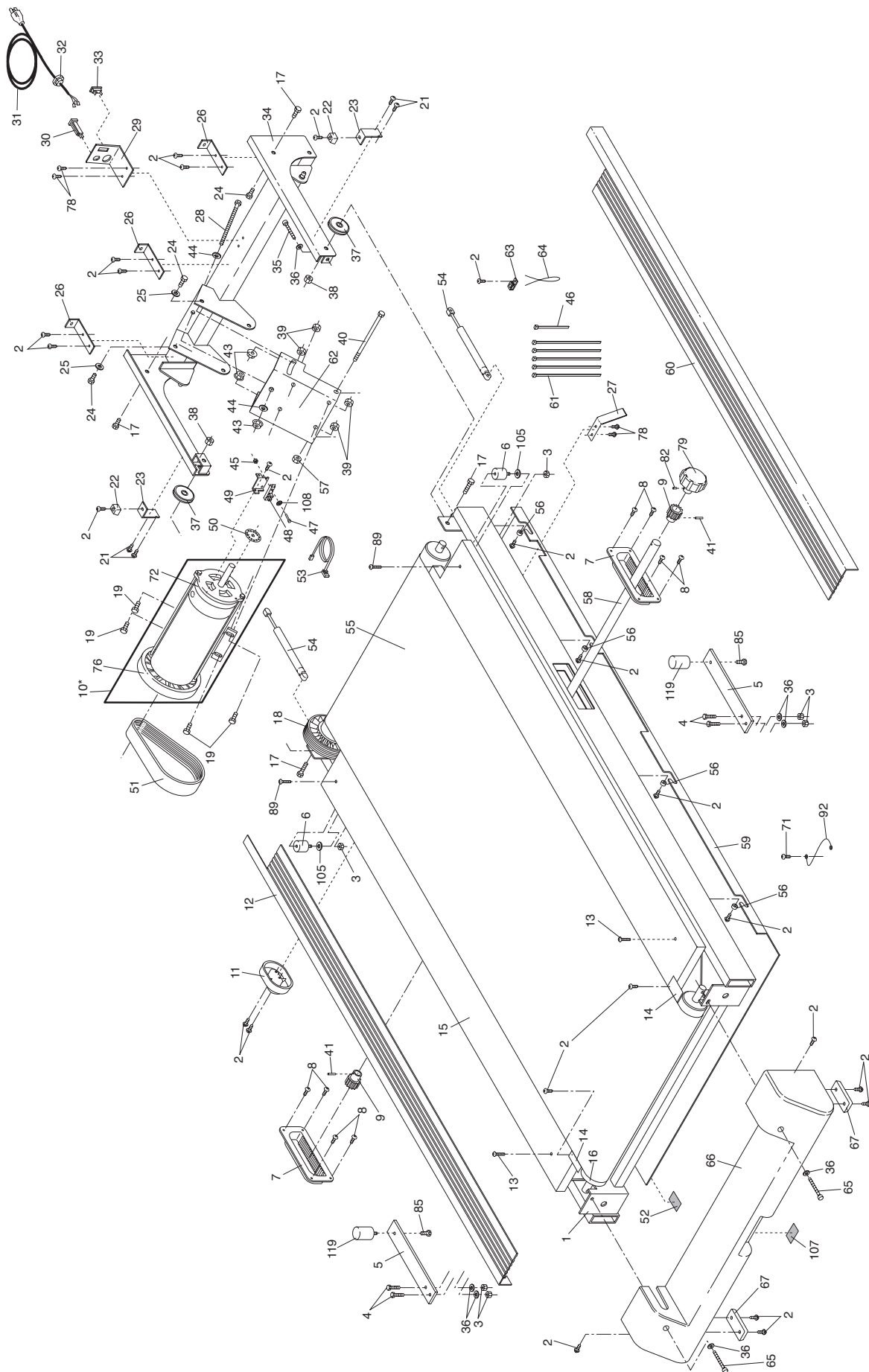







**Model No. 831.297572**

## QUESTIONS?

If you find that:

- you need help assembling or operating the IMAGE® 10.6Q treadmill
- a part is missing
- or you need to schedule repair service

call our toll-free HELPLINE

**1-800-736-6879**

Monday–Saturday, 7 am–7 pm  
Central Time (excluding holidays)

## REPLACEMENT PARTS

If parts become worn and need to be replaced, call the following toll-free number

**1-800-FON-PART  
(1-800-366-7278)**

The model number and serial number of your IMAGE® 10.6Q treadmill are listed on a decal attached to the frame. See the front cover of this manual to find the location of the decal.

All replacement parts are available for immediate purchase or special order when you visit your nearest SEARS Service Center. To request service or to order parts by telephone, call the toll-free numbers listed at the left.

When requesting help or service, or ordering parts, please be prepared to provide the following information:

- The NAME OF THE PRODUCT (IMAGE® 10.6Q treadmill)
- The MODEL NUMBER OF THE PRODUCT (831.297572)
- The PART NUMBER AND DESCRIPTION OF THE PART (see the PART LIST on page 22 and the EXPLODED DRAWING attached in the center of this manual)

## FULL ONE YEAR WARRANTY

For one year from the date of purchase, if failure occurs due to defect in material or workmanship in this SEARS TREADMILL EXERCISER, contact the nearest SEARS Service Center throughout the United States and SEARS will repair or replace the TREADMILL EXERCISER, free of charge.

This warranty does not apply when the TREADMILL EXERCISER is used commercially or for rental purposes.

This warranty gives you specific legal rights, and you may also have other rights which vary from state to state.

**SEARS, ROEBUCK AND CO., DEPT. 817WA, HOFFMAN ESTATES, IL 60179**

## Free Manuals Download Website

<http://myh66.com>

<http://usermanuals.us>

<http://www.somanuals.com>

<http://www.4manuals.cc>

<http://www.manual-lib.com>

<http://www.404manual.com>

<http://www.luxmanual.com>

<http://aubethermostatmanual.com>

Golf course search by state

<http://golfingnear.com>

Email search by domain

<http://emailbydomain.com>

Auto manuals search

<http://auto.somanuals.com>

TV manuals search

<http://tv.somanuals.com>