



## USER'S GUIDE

V: 1407-0603-09



# IS809B

## Wireless Speaker System

*For the most up-to-date version of this User's Guide, go to [www.ilive.net](http://www.ilive.net)*

## WARNINGS AND PRECAUTIONS

- **CAUTION:** TO PREVENT ELECTRIC SHOCK, MATCH WIDE BLADE OF PLUG TO WIDE SLOT, FULLY INSERT.
- **WARNING:** While these speakers are water resistant, to prevent the risk of fire or shock, do not immerse these speakers in water and remove these speakers from an outdoor environment that is experiencing rain.
- **CAUTION:** Use of controls or adjustments or performance of procedures other than those specified may result in hazardous radiation exposure.
- **WARNING:** Changes or modifications to this unit not expressly approved by the party responsible for compliance could void the user's authority to operate the equipment.
- **WARNING:** Do not place the unit on top of any soft, porous, or sensitive surfaces to avoid damaging the surface. Use a protective barrier between the unit and surface to protect the surface.
- **WARNING:** Use of this unit near fluorescent lighting may cause interference regarding use of the remote. If the unit is displaying erratic behavior move away from any fluorescent lighting, as it may be the cause.



- **CAUTION:** Danger of explosion if battery is incorrectly replaced. Replace only with the same or equivalent type.
- **PRÉCAUTION:** *Danger d'explosion si les piles sont remplacées de façon incorrecte. Remplacer les piles seulement par le même type de pile ou l'équivalent.*

Do not mix old and new batteries.

Do not mix alkaline, standard (carbon-zinc), or rechargeable (ni-cad, ni-mh, etc) batteries.

*No mezcle baterías viejas y nuevas.*

*No mezcle baterías alcalinas, estándar (carbono-zinc) o recargables (ni-cad, ni-mh, etc.).*

<p><b>CAUTION</b> RISK OF ELECTRIC SHOCK DO NOT OPEN</p>	<p><b>WARNING:</b> TO REDUCE THE RISK OF ELECTRIC SHOCK, DO NOT REMOVE COVER (OR BACK). NO USER-SERVICEABLE PARTS INSIDE. REFER SERVICING TO QUALIFIED SERVICE PERSONNEL.</p>
	<p>The lightning flash with arrowhead symbol, within an equilateral triangle, is intended to alert the user to the presence of uninsulated "dangerous voltage" within the product's enclosure that may be of sufficient magnitude to constitute a risk of electric shock to persons.</p>
	<p>The exclamation point within an equilateral triangle is intended to alert the user to the presence of important operating and maintenance (servicing) instructions in the literature accompanying the appliance.</p>

## IMPORTANT SAFETY INSTRUCTIONS

1. Read these Instructions.
2. Keep these Instructions.
3. Heed all Warnings.
4. Follow all instructions.
5. Do not use this apparatus near water.
6. Clean only with a dry cloth.
7. Do not block any ventilation openings. Install in accordance with the manufacturer's instructions.
8. Do not install near any heat sources such as radiators, heat registers, stoves, or other apparatus (including amplifiers) that produce heat.
9. Do not defeat the safety purpose of the polarized or grounding - type plug. A polarized plug has two blades with one wider than the other. A grounding type plug has two blades and a third grounding prong. The wide blade or the third prong are provided for your safety. When the provided plug does not fit into your outlet, consult an electrician for replacement of the obsolete outlet.
10. Protect the power cord from being walked on or pinched particularly at plugs, convenience receptacles, and the point where they exit from the apparatus.
11. Only use attachments/accessories specified by the manufacturer.
12. Use only with a cart, stand, tripod, bracket, or table specified by the manufacturer, or sold with the apparatus. When a cart is used, use caution when moving the cart/apparatus combination to avoid injury from tip-over.



13. Unplug this apparatus during lightning storms or when unused for long periods of time.
14. Refer all servicing to qualified service personnel. Servicing is required when the apparatus has been damaged in any way, such as power-supply cord or plug is damaged, liquid has been spilled or objects have fallen into the apparatus, the apparatus has been exposed to rain or moisture, does not operate normally, or has been dropped.

## FCC Warnings

NOTE: This equipment has been tested and found to comply with the limits for a Class B digital device, pursuant to Part 15 of the FCC Rules. These limits are designed to provide reasonable protection against harmful interference in a residential installation. This equipment generates, uses, and can radiate radio frequency energy and, if not installed and used in accordance with the instructions, may cause harmful interference to radio communications. However, there is no guarantee that interference will not occur in a particular installation. If this equipment does cause harmful interference to radio or television reception, which can be determined by turning the equipment off and on, the user is encouraged to try to correct the interference by one or more of the following measures:

- Reorient or relocate the receiving antenna.
- Increase the separation between the equipment and receiver.
- Connect the equipment into an outlet on a circuit different from that to which the receiver is connected.
- Consult the dealer or an experienced radio/TV technician for help.

## Additional Warnings

This device complies with RSS 210 of Industry Canada. Operation is subject to the following two conditions: (1) this device may not cause interference, and (2) this device must accept any interference, including interference that may cause undesired operation of this device.

L'utilisation de ce dispositif est autorisée seulement aux conditions suivantes: (1) il ne doit pas produire de brouillage et (2) l'utilisateur du dispositif doit être prêt à accepter tout brouillage radioélectrique reçu, même si ce brouillage est susceptible de compromettre le fonctionnement du dispositif. The term "IC" before the equipment certification number only signifies that the Industry Canada technical specifications were met.

This equipment complies with Industry Canada Radio Frequency Electromagnetic Signal (RF) exposure limits set forth for an uncontrolled environment of portable transmission.

## What's Included

- IS809B
- Wireless Remote Control
- Docking Brackets for iPod
- Documentation

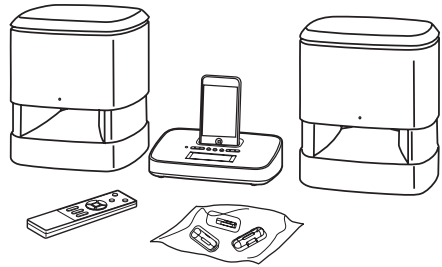

## Features

- Dock plays and charges iPod
- Wireless speakers
- Supports up to 20 speakers
- Advanced hi-fi sound with Channel Purity®
- Wireless remote
- Digital volume control
- Pairing button
- Left, right, or mono selections
- Weather resistant
- Digital 2.4GHz ISM wireless transmitter
- LCD display with white backlight
- Digital clock
- Play/pause, skip up/down functions for iPod
- On/Off, mute, function and pairing controls
- Independent volume settings for each speaker
- Transmission range: up to 200ft (line of sight) and 90ft indoors
- Auxiliary input for iPod shuffle and other audio devices
- AC power: built-in AC cord
- DC power: requires 6 D batteries per speaker, not included

## POWERING THE BASE STATION AND REMOTE

### Base Station AC Power

Power the base station by connected it to a standard AC outlet using the attached AC power cord.

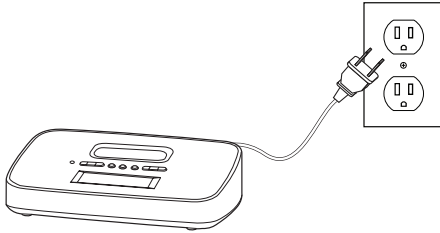

### Base Station Battery Backup

Requires 2 AAA batteries (not included).

The battery backup is meant for keeping the clock and timer settings during short unexpected power outages. The unit's other features cannot function off of the battery backup alone.

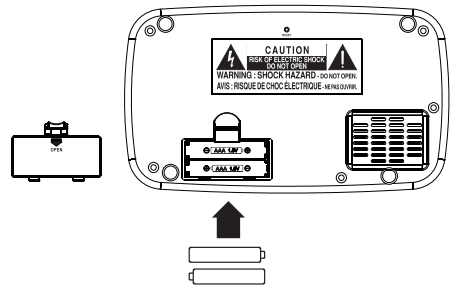

### Remote

Requires 2 AAA batteries (not included).

Power the remote by inserting 2 AAA batteries into the battery compartment on the back of the remote.

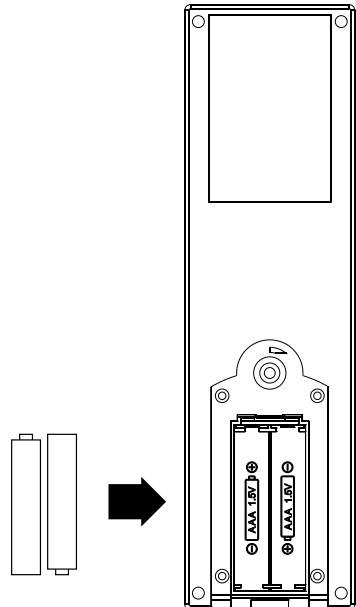

## POWERING THE WIRELESS SPEAKERS

### Wireless Speaker AC Power

Power the wireless speakers by connected them to a standard AC outlet using the attached AC power cord.

The AC cord is stored inside of the wireless speaker's battery compartment.

*After extending the AC cord out from the battery compartment, snap the battery compartment door back into position to keep the internal elements of the wireless speaker from being exposed.*

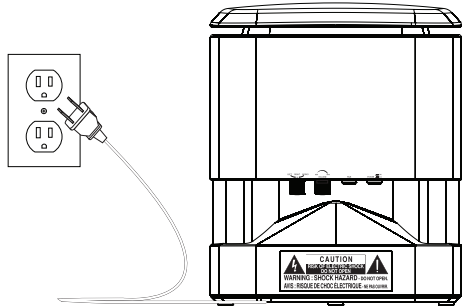

### Wireless Speaker DC Battery Power

Requires 6 D batteries (not included).

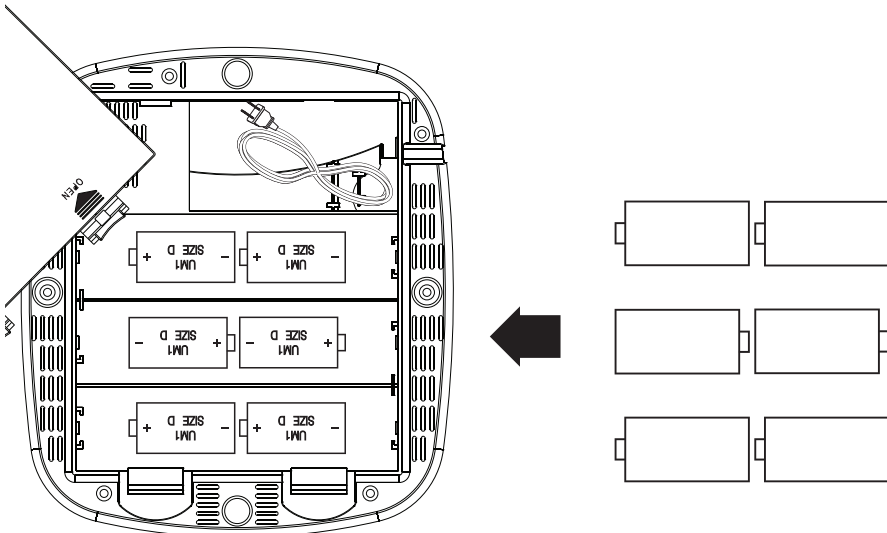

## INTRODUCTION

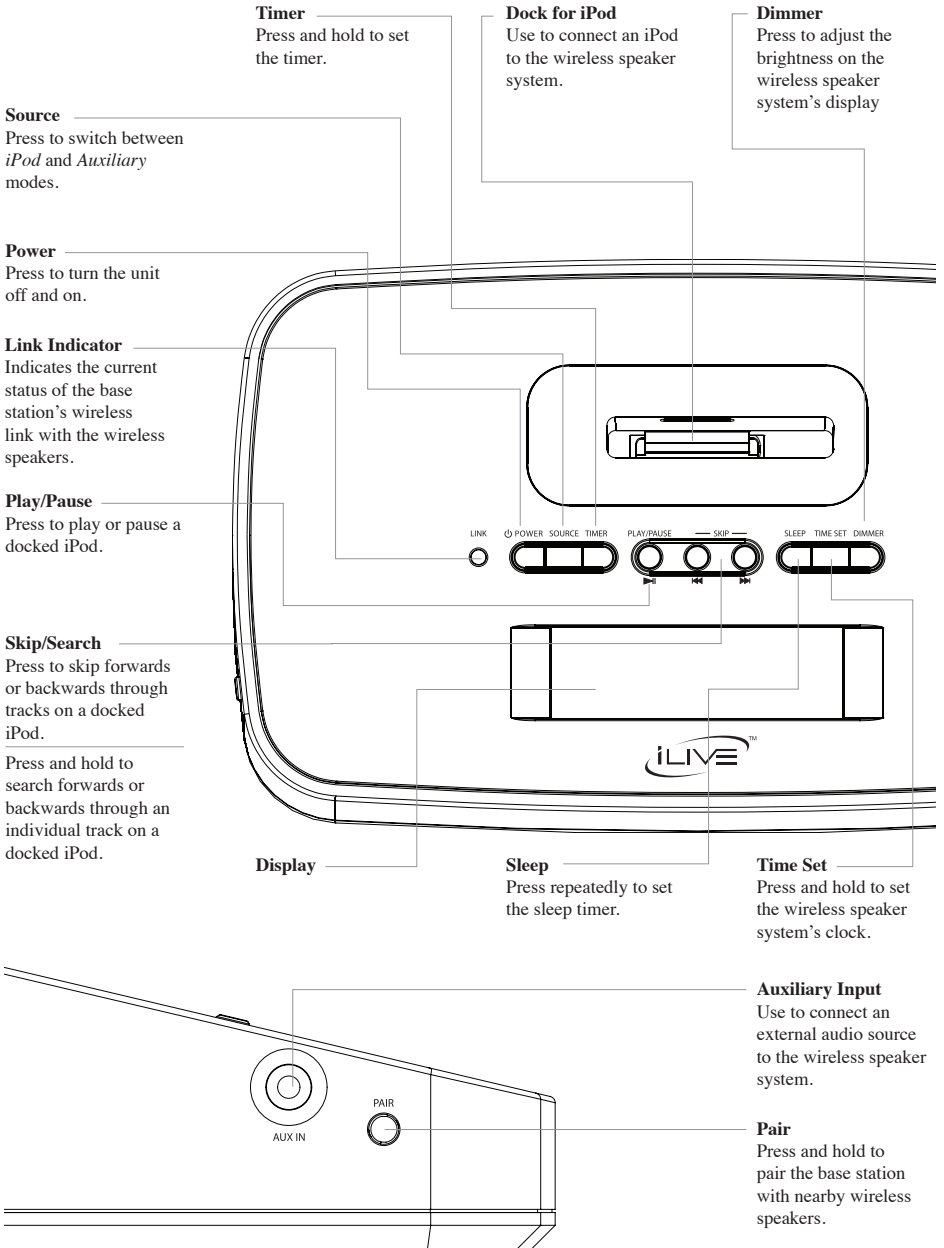

**Power**  
Press to turn the unit off and on.

**Source**  
Press to switch between *iPod* and *Auxiliary* modes.

**Repeat**  
Press to activate the repeat options on a docked *iPod*.

**Skip/Search**  
Press to skip forwards or backwards through tracks on a docked *iPod*.

Press and hold to search forwards or backwards through an individual track on a docked *iPod*.

**Treble**  
Press to adjust the level of treble output from the linked speakers.

**Battery Compartment**  
Located on the back of the remote. Requires 2 AAA batteries, not included.

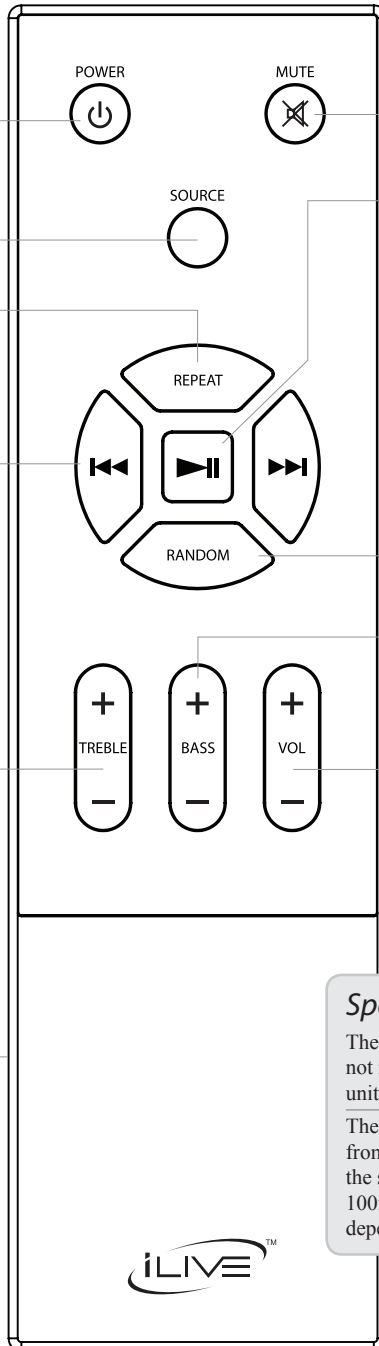

**Mute**  
Press to mute the volume of the unit.

**Play/Pause**  
Press to play or pause a docked *iPod*.

**Random**  
Press to activate the shuffle option on a docked *iPod*.

**Bass**  
Press to adjust the level of bass output from the linked speakers.

**Volume**  
Press to adjust the volume of the unit.

**Special Note**  
The included remote is wireless and does not require line-of-sight to control the unit.  
The wireless remote can control the unit from approximately half the distance of the speaker reception. (Approximately 100ft line-of-sight, or 45ft indoors depending on location)

**Left/Right/Mono**  
Adjust to switch between *Left*, *Right*, and *Mono* speaker modes.

**Speaker Volume**  
Turn to adjust the volume of the wireless speaker.

**Pair**  
Press and hold to pair the speaker with nearby base stations.

**Power**  
Press to turn the speaker off and on.

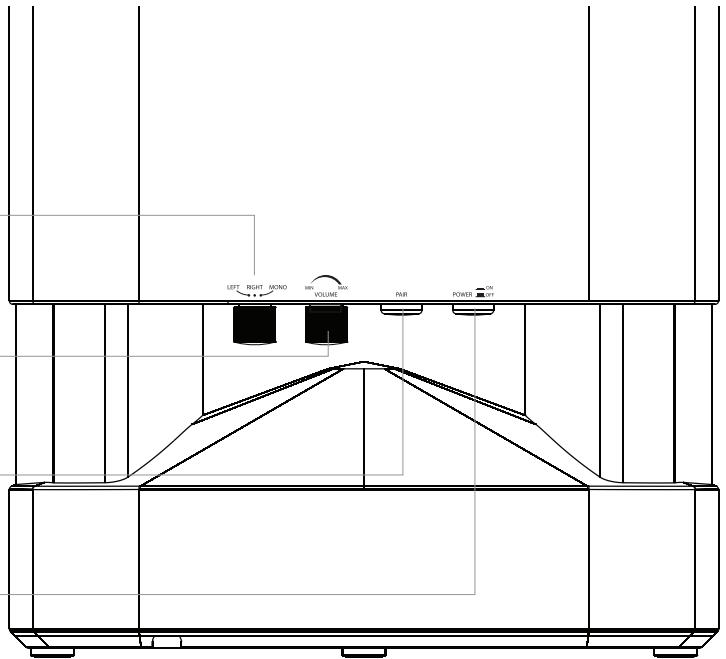

**Battery Compartment**  
Requires 6 D batteries, not included.

**AC Power Cord**  
Use to connect the wireless speaker to a standard AC outlet.

**Link Indicator**  
Indicates the current status of the wireless speaker's link with the base station.

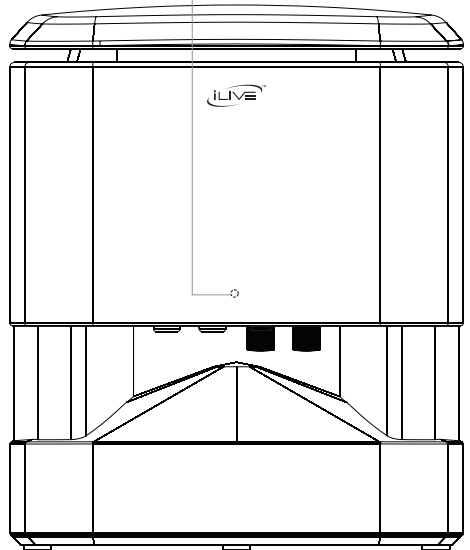
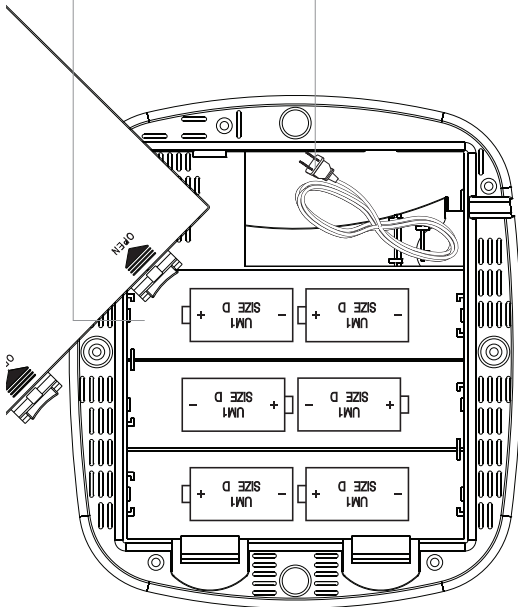



## PAIRING THE WIRELESS SPEAKERS WITH THE BASE STATION

### What does it mean to Pair?

Pairing the base station with a wireless speaker allows the base station to recognize that wireless speaker. Once paired, the base station will remember that wireless speaker and transmit audio through it.

### Link Indicators

#### Off

Powered off.

#### Slow Flashes

Standby mode.

#### Quick Flashes

Attempting to pair.

#### Solid Light

Paired and playing.

*If the base station is not playing audio, either from the dock for iPod or the Auxiliary input, then both the base station and wireless speakers will go into Standby mode. Once you begin playing audio from the base station, both the base station and wireless speaker will come out of Standby mode.*

### Transmission Range

Once the base station is paired with a wireless speaker, the wireless speaker can be moved approximately 200ft (line-of-sight) or 90ft (indoors) and still receive audio from the base station.

*Results will vary depending on the number and size of obstructions between the base station and the wireless speaker.*

### How many speakers can I pair to one base station?

Up to 20 wireless speakers can be paired with one base station. Additional speakers are sold separately.

### Pairing

*The two wireless speakers included in the same box as the base station are pre-paired with that base station. Any additional speakers will need to be paired by following the directions below.*

*When pairing the base station with a wireless speaker you will need to press the **Pair** button on the base station and wireless speaker simultaneously. Because of this, you will need to have both the base station and wireless speaker within reach when you pair them.*

1. Plug the base station into a power source, and press the **Power** button to power the base station on.

*The base station **Link Indicator** will flash when the base station is powered on.*

2. Plug the wireless speaker into a power source or insert 6 D batteries, not included, and press the **Power** button to power the wireless speaker on.

*The wireless speaker **Link Indicator** will flash when the wireless speaker is powered on.*

3. Adjust the **Volume** on the wireless speaker to approximately the half-way point between min. and max volume.
4. Simultaneously press and hold the **Pair** button on the base station and the **Pair** button on the wireless speaker for 5 seconds.
5. The wireless speaker will emit a long beep when it is paired with the base station.

*If the wireless speaker emits short repeating beeps, it was not able to pair with the base station. Repeat steps 1-4 until you hear the long beep.*

After pairing, the wireless speaker may take up to 30 seconds to begin playing audio from the paired base station.

Repeat steps 1-4 for each additional wireless speaker you want to pair with the base station.

## OPERATIONS

### Setting the Clock

1. Press and hold the **Time Set** button.
2. While holding the **Time Set** button, press the **Skip/Search** buttons to adjust the hour and minute.
3. Release the **Time Set** button to set the adjusted time.

### Setting the Sleep Timer

1. Press the **Sleep** button repeatedly to adjust the sleep timer between 60 and 10 minutes, in 10 minute increments.

*When the set amount of time has expired, the unit will power off.*

### Using the Auxiliary Input

*Note: The speakers need to be paired with the unit before any audio can be heard.*

1. Connect a mini-phono 3.5mm cable (not included) or a mini-phono 3.5mm cable-RCA R/L audio cable (not included) to the **Auxiliary Input** on the unit and the audio output/headphone jack on an MP3 player, television, or stereo system.
2. Turn the unit on by pressing the **Power** button.
3. Press the **Source** button to switch the unit to *Auxiliary* mode.
4. Audio played through the connected MP3 player, television, or stereo system will now be heard through the unit.

Audio Source	Required Connector
MP3 Player	mini-phono 3.5mm Cable (not included)
Television	mini-phono 3.5mm Cable - RCA R/L Audio Cable (not included)
Stereo System	mini-phono 3.5mm Cable - RCA R/L Audio Cable (not included)

### Setting the Timer

1. Press and hold the **Timer** button.
2. While holding the **Timer** button, press the **Skip/Search** buttons to adjust the hour and minute.
3. Release the **Timer** button to set the adjusted timer.
4. Press the **Source** button to select *iPod* or *Auxiliary* mode.

*An iPod must be docked, or an audio source must be connected to the Auxiliary input when the set time is reached. Otherwise, no audio will play when the set time is reached.*

5. Press the **Power** button to turn the unit off.
6. Press the **Timer** button to activate the set timer.

*"Timer On" will appear on the LCD display when the timer is activated.*

*After the set time is reached, the base station will power on.*

**IMPORTANT:** The wireless speakers must be powered on manually before the set time is reached. The timer will not power on the paired wireless speakers.

### Using the Wireless Remote

The included remote is wireless and does not require line-of-sight to control the unit.

The wireless remote can control the base station from approximately half the distance of the speaker reception. (Approximately 100ft line-of-sight, or 45ft indoors)

*Results will vary depending on the number and size of obstructions between the base station and the wireless remote.*

The **Volume** buttons on the remote control will adjust the master volume of the base station, affecting all linked speakers.

*The included speakers have independent volume controls that can be used to fine tune the volume of the individual speakers.*

### Docking an iPod

1. Locate the numbered bracket that fits the iPod that will be docked.

*Each included Bracket has a number on it, indicating which iPod model that bracket is compatible with. See the separate bracket chart page to identify which bracket is needed.*

2. Snap the bracket into place over the iPod connector in the **Dock for iPod**.
3. Connect the iPod to the iPod connector.

*When the unit is plugged in, using AC power, the docked iPod will charge.*

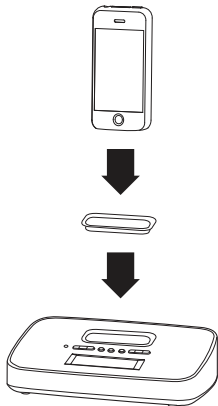

### Playing a Docked iPod

*Note: The wireless speakers need to be paired with the unit before any audio can be heard. See page 9 for wireless speaker pairing instructions.*

1. Press the **Power** button to turn the base station on.
2. Press the **Source** button to switch to iPod mode.
3. Press the **Play/Pause** button to play or pause the docked iPod.

### Left / Right / Mono Speaker Settings

The wireless speakers can be set to Left, Right, or Mono by using the **Left/Right/Mono** dial on the wireless speaker.

When placing multiple wireless speakers in close proximity to one another, set half of the speakers to *Left* and the other half to *Right*. This will create a stereo audio output.

When a single wireless speaker is set in a location, adjust the **Left/Right/Mono** dial to *Mono*.

### Resetting the Unit

Resetting the base station is the quickest and most effective way to solve small unexpected problems with the base station's behavior.

1. Using a paperclip or like object, press the **Reset** button to reset the base station to its original settings.

*Please note, resetting the base station will not unpair any of the wireless speakers from the base station.*

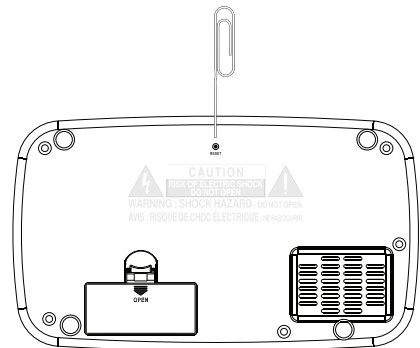

## COMPANY INFORMATION

### International Support

To download this User's Guide in English, Spanish, or French, visit the support section at [www.ilive.net](http://www.ilive.net).

Para transferir esta guía de usuario en inglés, español, o francés, visite la sección de la ayuda en [www.ilive.net](http://www.ilive.net).

Pour télécharger ce guide de l'utilisateur en anglais, espagnol, ou français, visitez la section de soutien chez [www.ilive.net](http://www.ilive.net).

### Contact Information

Address: 2116 Carr Street, St. Louis MO, 63106

Phone: 1-314-621-2881

Fax: 1-314-588-1805

Email: [customerservice@ilive.net](mailto:customerservice@ilive.net)

Parts Email: [partsinfo@dpi-global.com](mailto:partsinfo@dpi-global.com)

Website: [www.ilive.net](http://www.ilive.net)

## Free Manuals Download Website

<http://myh66.com>

<http://usermanuals.us>

<http://www.somanuals.com>

<http://www.4manuals.cc>

<http://www.manual-lib.com>

<http://www.404manual.com>

<http://www.luxmanual.com>

<http://aubethermostatmanual.com>

Golf course search by state

<http://golfingnear.com>

Email search by domain

<http://emailbydomain.com>

Auto manuals search

<http://auto.somanuals.com>

TV manuals search

<http://tv.somanuals.com>