

Grizzly Industrial, Inc.®

MODEL H6332 1 1/4" BRAD NAILER OWNER'S MANUAL



COPYRIGHT © OCTOBER, 2005 BY GRIZZLY INDUSTRIAL, INC., REVISED DECEMBER, 2007 (TS)
WARNING: NO PORTION OF THIS MANUAL MAY BE REPRODUCED IN ANY SHAPE OR FORM WITHOUT THE WRITTEN APPROVAL OF GRIZZLY INDUSTRIAL, INC.
#JK7652 PRINTED IN CHINA

SAFETY

WARNING

For Your Own Safety Read Instruction Manual Before Operating This Equipment

The purpose of safety symbols is to attract your attention to possible hazardous conditions. This manual uses a series of symbols and signal words which are intended to convey the level of importance of the safety messages. The progression of symbols is described below. Remember that safety messages by themselves do not eliminate danger and are not a substitute for proper accident prevention measures.



Indicates an imminently hazardous situation which, if not avoided, WILL result in death or serious injury.



Indicates a potentially hazardous situation which, if not avoided, COULD result in death or serious injury.



Indicates a potentially hazardous situation which, if not avoided, MAY result in minor or moderate injury. It may also be used to alert against unsafe practices.

NOTICE

This symbol is used to alert the user to useful information about proper operation of the equipment.

WARNING

Safety Instructions For Pneumatic Tools

1. **KEEP ALL SAFETY DEVICES IN PLACE** and in working order.
2. **REMOVE ADJUSTING KEYS AND WRENCHES.** Form habit of checking to see that keys and adjusting wrenches are removed from tool before operation.
3. **KEEP WORK AREA CLEAN.** Cluttered areas and benches invite accidents.
4. **DO NOT USE IN DANGEROUS ENVIRONMENT.** Do not use pneumatic tools in damp or wet locations, or where any flammable or noxious fumes may exist. Keep work area well lighted.
5. **KEEP CHILDREN AND VISITORS AWAY.** All children and visitors should be kept at a safe distance from work area.
6. **MAKE WORKSHOP CHILD PROOF** by locking your shop and shutting off air valves.
7. **DO NOT FORCE TOOL.** It will do the job better and safer at the rate for which it was designed.
8. **USE THE RIGHT TOOL.** Do not force tool or attachment to do a job for which it was not designed.
9. **DO NOT USE UNDER THE INFLUENCE OF DRUGS OR ALCOHOL.**

WARNING

Safety Instructions For Pneumatic Tools

10. **USE PROPER AIR HOSE** for the tool. Make sure your air hose is in good condition and is long enough to reach your work without stretching.
11. **WEAR PROPER APPAREL.** Do not wear loose clothing, gloves, neckties, rings, bracelets, or other jewelry which may get caught in moving parts. Non-slip footwear is recommended. Wear a protective hair covering to contain long hair.
12. **ALWAYS USE SAFETY GLASSES.** Also use a face or dust mask if operation is dusty. Everyday eyeglasses only have impact resistant lenses, they are NOT safety glasses.
13. **WEAR APPROVED HEARING PROTECTION.** Air escaping from pneumatic tools can exceed safe exposure limits and may cause hearing damage with prolonged exposure.
14. **SECURE WORK.** Use clamps or a vise to hold work when practical. It is safer than using your hand and frees both hands to operate tool.
15. **MAINTAIN TOOLS WITH CARE.** Keep tools lubricated and clean for best and safest performance. Follow instructions for lubricating and changing accessories.
16. **REDUCE THE RISK OF UNINTENTIONAL FIRING.** Do not carry tool with hand on trigger and always disconnect from air when not in use.
17. **DISCONNECT TOOLS** before servicing, changing accessories, or moving to another location.
18. **DO NOT OVERREACH.** Keep proper footing/balance at all times.
19. **USE THE RECOMMENDED ACCESSORIES.** Consult owner's manual for recommended accessories. The use of improper accessories may cause risk of injury.
20. **CHECK FOR DAMAGED PARTS BEFORE USING.** Check for binding and alignment of parts, broken parts, part mounting, loose bolts, and any other conditions that may affect machine operation. Repair or replace damaged parts.
21. **NEVER LEAVE UNATTENDED TOOL CONNECTED TO AIR.** Disconnect the air hose and do not leave tool until it is relieved of any built up pressure.
22. **NEVER ALLOW UNTRAINED USERS TO USE THIS TOOL WHILE UNSUPERVISED.**
23. **IF YOU ARE UNSURE OF THE INTENDED OPERATION, STOP USING TOOL.** Seek formal training or research books or magazines that specialize in pneumatic tools.
24. **BE AWARE OF HOSE LOCATION WHEN USING PNEUMATIC TOOLS.** Hoses can easily become a tripping hazard when laid across the floor or spread out in a disorganized fashion.

WARNING

Additional Safety Instructions for Nailers

1. **HAND INJURIES:** Do not place your hands near the nail point of entry. A nail can deflect and tear through the surface of the workpiece, puncturing your hand or fingers.
2. **COMBUSTIBLE GASES:** Never connect the nailer to pressurized oxygen or other combustible gases as a power source. Only use filtered, lubricated, and regulated compressed air.
3. **SAFE HANDLING:** Never point the nailer at others! Do not keep the trigger pulled when loading fasteners, carrying, or holding tool. Carry the nailer only by the handle, never by any other part. Do not carry the nailer by the air hose. Disconnect the nailer from the air hose when going up and down ladders.
4. **CLEANING:** Never use gasoline or other flammable liquids to clean the nailer; vapors in the nailer will ignite by a spark and cause it to explode.
5. **HOSE USAGE:** Make sure your air hose is designed for the tool in use, is in good condition, and is long enough to reach your work without stretching. However, an overly long air hose in the work area may be a tripping hazard.
6. **OPERATING QUESTIONS:** If you are not sure about the intended operation, stop using the nailer. Seek formal training or research books or magazines that specialize in pneumatic tools.
7. **MAINTENANCE:** Always disconnect air from the nailer when servicing or installing nails. During maintenance, a nailer connected to air may fire accidentally, causing serious personal injury.
8. **COMPRESSED AIR RATING:** Do not connect the nailer to compressed air that exceeds 120 PSI.
9. **CHECK VALVE:** Do not use a check valve or any other fitting that allows air to remain in the tool.

! WARNING

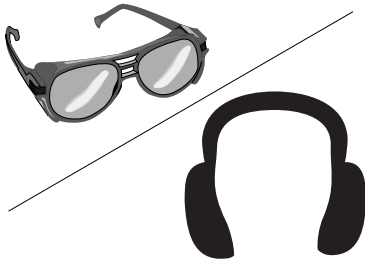

Operating this nailer can propel objects into the air, causing immediate eye damage. To protect yourself, always wear American National Standards Institute (ANSI) approved safety glasses or goggles when operating this equipment. In addition, this nailer discharges at up to 85-90 decibels. To protect your hearing, always wear ANSI approved ear protection when operating this nailer.

! WARNING

Never point this nailer at yourself or another person! Always pay attention to the direction this nailer is pointed. Use this tool with respect and caution to lessen the possibility of operator or bystander injury. Ignoring this warning may result in serious personal injury.

! CAUTION

Nailer/stapler accidents routinely happen while moving the gun to another location, such as up ladders, to another room, or even another job site. Always disconnect the gun immediately after use and never transport the gun while connected to the air—even if the air compressor is disconnected from its power source!

! CAUTION

No list of safety guidelines can be complete. Every shop environment is different. Always consider safety first, as it applies to your individual working conditions. Use this and other tools with caution and respect. Failure to do so could result in serious personal injury, damage to equipment or poor work results.

SET UP

Unpacking

Your Model H6332 left our warehouse in a carefully packed box. If you discover the nailer is damaged after you have signed for delivery, *please immediately call Customer Service at (570) 546-9663 for advice.*

Save the containers and all packing materials for possible inspection by the carrier or its agent. *Otherwise, filing a freight claim can be difficult.*

When you are completely satisfied with the condition of the shipment, you should inventory the equipment.

Inventory

After you open the nailer box, you should find the following.

Model H6332 Inventory (Figure 1)

- | | |
|-----------------------------|---|
| A. Nailer..... | 1 |
| B. Pneumatic Tool Oil | 1 |
| C. Hex Wrench 3mm | 1 |
| D. Hex Wrench 4mm | 1 |



Figure 1. Model H6332 inventory.

Compressed Air System

The Model H6332 is designed to be operated at 60-100 PSI using clean, dry, regulated, compressed air. **DO NOT exceed the 120 PSI maximum operating pressure for your model.**

Before using your new nailer, regulate the air pressure on your air compressor to the minimum PSI for your model.

An in-line filter/lubricator/regulator unit, depicted in **Figure 2**, can be installed and should be located as close to the nailer as possible.

The filter/lubricator/regulator unit will protect your tool from damaging water build-up, allow you to adjust and maintain constant air pressure to your tool, and save you the inconvenience of having to manually lubricate your tool every time you use it.

⚠ WARNING

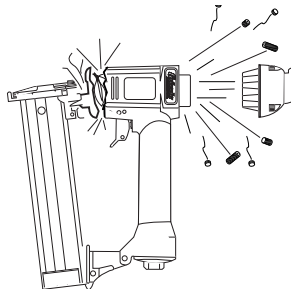

Exceeding the maximum permissible operating pressure may cause the nailer to explode, blowing metal fragments in all directions. To protect yourself from serious personal injury, DO NOT allow your air compressor to exceed the recommended pressure when connected to this nailer!

Check the current Grizzly catalog for availability of this unit. If you plan on installing a filter/lubricator/regulator unit in your compressed air system, always follow the connection instructions that come with the unit.

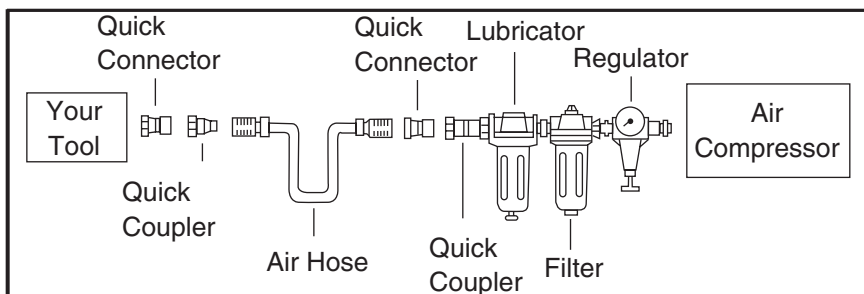

Figure 2. Typical filter/lubricator/regulator installation order.

Safety Nose Mechanism

A safety mechanism on the nose of the nailer protects against accidental firing. When the trigger is pressed, the nailer will not fire until the safety nose mechanism is depressed.

Before you use your nailer for the first time, check the safety nose mechanism to ensure proper function. To do this:

1. DISCONNECT NAILER FROM THE AIR SUPPLY!

2. Make sure the magazine is empty and contains no nails.
3. Make sure the trigger and the safety nose mechanism move up and down without sticking.
4. Connect the nailer to the air supply.

WARNING

The safety mechanism is a mechanical device that could fail. Never rely on this mechanism as an excuse to point the nailer at yourself or any bystanders. Serious injury may occur.

5. **Without pressing the trigger**, depress the safety nose mechanism against a scrap piece of wood that is clean and free of any knots, nails, or other foreign objects.

- If the nailer does not fire, then the safety nose mechanism is working correctly.
- If the nailer **does fire** when you do this, immediately disconnect the nailer from the air supply and call Grizzly Technical Support at (570) 546-9663 for help.
- If the nailer fires when the trigger is pulled, without the safety nose mechanism being depressed, then the nailer is not working properly. If this occurs, call Grizzly Technical Support at (570) 546-9663 for help.
- If you find that the safety nose mechanism is not working properly, check the lubrication of its sliding components.

OPERATIONS

Loading

When replacing nails in your Model H6332, follow these guidelines:

Gauge: 18
Length: $\frac{3}{8}$ " – $1\frac{1}{4}$ "
Capacity: 100

To load your nailer:

1. DISCONNECT NAILER FROM THE AIR SUPPLY!
2. Grip the nailer firmly, release the catch lever and slide the magazine pusher open, as shown in **Figure 3**.

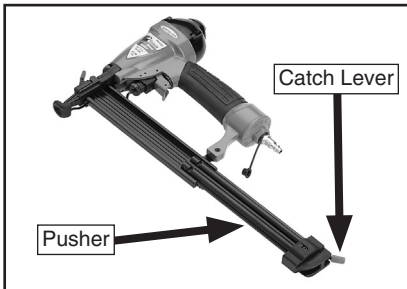

Figure 3. Releasing catch lever and sliding magazine pusher back.

3. Insert a strip of nails, pointed-end down, into the magazine as shown in **Figure 4**.

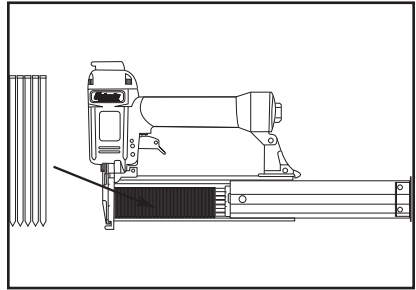

Figure 4. Loading nails into magazine.

4. Slide the nails all the way down to the nose of the nailer.
5. Slide the pusher back until the catch lever locks.

Operating

If you have not read the safety instructions in this manual, do not operate the nailer.

Before you operate your nailer, place five to six drops of the included oil into the quick connect fitting where the nailer connects to the air supply.

To operate your nailer:

1. Connect the air supply to the quick connect fitting.
2. To test for proper nail penetration, hold the nailer perpendicular to the surface of a piece of clean scrap wood that is thick enough for the length of nails you have loaded.

3. Depress the safety nose mechanism against your workpiece.
4. Before pulling the trigger, make sure your free hand and other body parts are positioned out of the way of a potential path of a nail in case of deflection.

Deflection is caused when grain irregularities, knots or foreign objects inside the wood cause the nail to change its path, resulting in the nail puncturing the surface of the workpiece, as shown in **Figure 5**.

Besides damaging your workpiece, deflection can cause injury if your free hand is securing the workpiece in the location that the nail deflects.

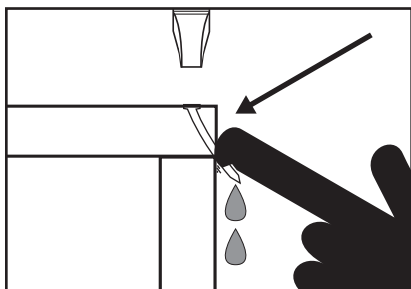

Figure 5. Example of nail deflection.

5. Pull the trigger.
 - If the nail drove into the wood far enough, continue with your intended operations.
 - If the nail either went too far or not far enough, then go to the **Adjusting Depth** section on this page.

Adjusting Depth

A depth adjustment knob is attached to the nose for setting the nail depth.

To adjust the depth:

1. DISCONNECT NAILER FROM THE AIR SUPPLY!
2. Rotate the adjustment knob (**Figure 6**) clockwise to drive the nails deeper or counterclockwise to drive the nails shallower.

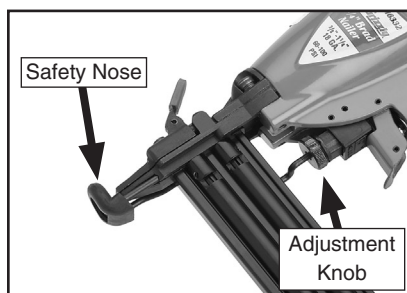

Figure 6. Depth adjustment controls.

3. Connect the nailer to the air supply, test the nail depth, and repeat this procedure until the nail depth is satisfactory.

Clearing Jammed Nails

A jammed nail must be cleared before using the nailer again.

To clear a jammed nail from the discharge area:

1. DISCONNECT NAILER FROM THE AIR SUPPLY!
2. Release the catch lever and slide back the magazine pusher.
3. Remove the nail stick from the magazine.

4. Open the nailer nose by removing the rubber nose tip, depressing the nose release mechanism, and opening the nose cover as shown in **Figure 7**.

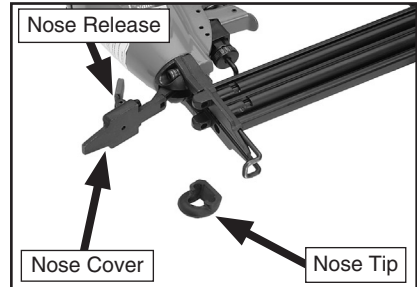

Figure 7. Nose opened to clear a jam.

5. Dislodge the jammed nail with a tool that will fit in the slot on the underside of the nose.
6. Throw the damaged nail away and insert a new nail stick that only contains clean, undamaged nails. **DO NOT** use dirty or damaged nails!
7. Slide the pusher back until it locks into position.

Replacing Pistons/O-Rings

If you use your nailer day in and day out, repair pistons are cheap insurance against wasted down time and lost profits, in the event that a piston or piston shaft becomes worn out. A replacement piston and O-ring kit, part PH6332082, may be purchased for the Model H6332.



To replace a piston:

1. DISCONNECT NAILER FROM THE AIR SUPPLY!
2. Remove all nails from the magazine cartridge.
3. Remove the four cap screws on the top of the nailer, near the exhaust port, and remove the cap. The top of the piston should now be visible inside the cylinder, which is housed in the head of the nailer.

4. Open the nose cover as if to clear a jammed nail.
5. Watch the discharge area and push the top of the piston with your finger. You will see the piston shaft slide down the discharge area.
6. With a long flathead screwdriver or similarly shaped tool, push the piston shaft back inside the nailer until you can grip the piston head and remove it from the cylinder. (Be careful not to scratch the discharge area when pushing the piston shaft with the screwdriver.)
7. Place a new O-ring on the new piston and apply a thin film of the nailer lubricating oil on the O-ring.
8. Insert the new piston in the cylinder. Make sure that the grooves on the piston shaft line up with those on the guide at the bottom of the cylinder. The new piston should easily slide into the cylinder. **DO NOT force the piston into the cylinder!** If the piston is not easily inserted, double-check the alignment of the piston shaft with the grooves on the guide.
9. After the piston is inserted correctly, close the magazine. Replace the top cap assembly and tighten the four cap screws.
10. For more assistance, or to install a complete O-ring set, refer to the break-down diagram in the back of this manual for component locations.

CLEANING & LUBRICATION

Cleaning

Use a good solvent to clean the nose assembly of the nailer. Always be sure that the nailer is dry before using it again.

Do not allow dust, chips, sand, etc. into the air connectors or into the body of the nailer; this may result in leaks and damage to the nailer and the air couplings.

⚠ WARNING



GAS

Never use gasoline or other flammable liquids to clean this tool. Vapors in the tool may ignite, causing the tool to explode. Ignoring this warning may lead to serious personal injury or even death!

Lubricating

Pneumatic tool oil has been included with your new Grizzly nailer to help maintain its useful life. Place two to six drops of oil in the nailer air inlet (as shown in **Figure 8**) before every use, or after 2 hours of continuous use.

Wipe off any excess oil near the nailer exhaust to avoid dust build-up. When the oil that was included with the nailer has been completely used, replace with Grizzly Model G2820 Pneumatic Tool Oil.

Another option to manual oiling would be to install a lubricator in your air compressor line. If your air compressor line already has a lubricator, then regular lubrication of your nailer will not be necessary. Just make sure there is always oil in the lubricator.

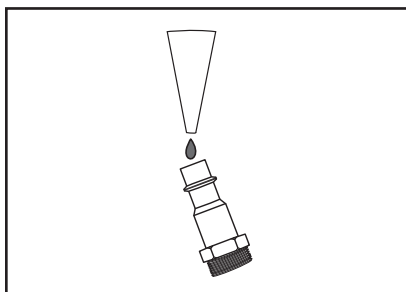
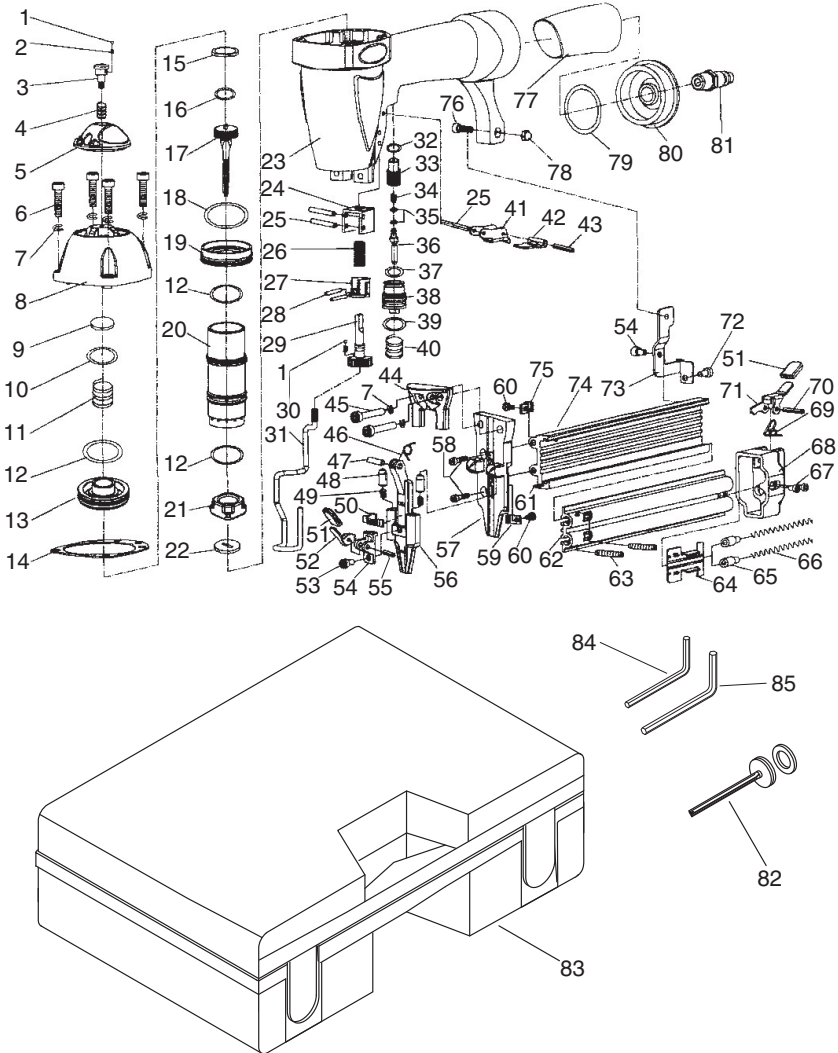

Figure 8. Lubricating nailer via air inlet.

TROUBLESHOOTING

Symptom	Possible Cause	Solution
Air leaking at trigger valve area.	1. O-rings in trigger valve housing are damaged.	1. O-rings must be replaced & operation of safety nose must be checked.
Air leaking between housing and hose.	1. Loose screws in housing. 2. Damaged O-ring. 3. Loose air fitting.	1. Tighten screws. 2. Replace O-ring. 3. Tighten air fitting & use teflon tape.
Air leaking between housing and cap assembly.	1. Damaged seal.	1. Replace damaged seals.
Tool skips nails while discharging.	1. Air leaks. 2. Dirt in nose. 3. Dirt or damage prevents nails from moving freely. 4. Inadequate air flow to tool. 5. Worn piston O-ring or lack of lubrication. 6. Damaged trigger valve O-rings. 7. Worn bumper. 8. Cap seal leaking.	1. Tighten screws and fittings. 2. Clean nose. 3. Clean magazine and inspect/repair damage. 4. Check fittings, hose, compressor & air pressure. 5. Replace O-ring and lubricate. 6. Replace trigger valve O-rings. 7. Replace bumper. 8. Replace cap seal.
Tool runs slowly or has a loss of power.	1. Nailer is not lubricated. 2. Broken spring in cap assembly. 3. Exhaust port in cap is blocked.	1. Lubricate nailer. 2. Replace spring. 3. Clean or replace damaged internal parts.
Fasteners frequently jam the nailer.	1. Nails are the wrong size. 2. Nails are bent or dirty. 3. Magazine or nose screws are loose. 4. Driver or driver guide are worn or damaged. 5. Nails are wrong angle.	1. Use correct nails. 2. Use undamaged, clean nails. 3. Tighten magazine. 4. Replace worn or damaged parts. 5. Use correct angle nails.
Nailer does not fire.	1. Nailer is not lubricated. 2. Nail is jammed in magazine or discharge area. 3. Piston shaft is damaged. 4. Air pressure too low.	1. Follow lubricating instructions. 2. Clear nailer magazine or discharge area. 3. Replace piston shaft. 4. Check/increase air pressure.
Air blows out of exhaust cap; nailer will not fire.	1. O-ring slipped out of groove or damaged inside nailer.	1. Reinstall/replace suspect O-ring; turn down the air pressure to prevent.

H6332 PARTS BREAKDOWN



H6332 PARTS LIST

REF PART #	DESCRIPTION
1	PH6332001 STEEL BALL
2	PH6332002 ORIENTATION SPRING
3	PH6332003 SHOULDER BOLT M4-.7 X 16
4	PH6332004 DIRECTION SPRING
5	PH6332005 AIR DEFLECTOR
6	PSB15M CAP SCREW M5-.8 X 20
7	PLW01M LOCK WASHER 5MM
8	PH6332008 CYLINDER CAP
9	PH6332009 SEALING WASHER 18MM
10	PH6332010 O-RING 17 X 2.65
11	PH6332011 COMPRESSION SPRING
12	PH6332012 O-RING 33.6 X 2
13	PH6332013 SWITCH PISTON
14	PH6332014 GASKET
15	PH6332015 O-RING 30 X 3
16	PH6332016 O-RING 23.5 X 2
17	PH6332017 MAIN PISTON
18	PH6332018 O-RING 48.7 X 2.65
19	PH6332019 COLLAR
20	PH6332020 CYLINDER
21	PH6332021 BUMPER
22	PH6332022 PISTON SLOT WASHER
23	PH6332023 GUN BODY
24	PH6332024 DIRECTION SEAT
25	PRP55M ROLL PIN 3 X 27
26	PH6332026 COMPRESSION SPRING
27	PH6332027 ADJUSTMENT SEAT
28	PH6332028 ROLL PIN 1.5 X 8
29	PH6332029 ADJUSTMENT BOLT
30	PH6332030 COMPRESSION SPRING
31	PH6332031 SAFETY GUARD
32	PH6332032 O-RING 7 X 1.5
33	PH6332033 TRIGGER VALVE GUIDE
34	PH6332034 COMPRESSION SPRING
35	PH6332035 O-RING 1.9 X 1.1
36	PH6332036 SWITCH PIPE
37	PH6332037 O-RING 11.2 X 1.6
38	PH6332038 SWITCH SEAT
39	PH6332039 O-RING 13.2 X 1.9
40	PH6332040 COMPRESSION SPRING
41	PH6332041 TRIGGER
42	PH6332042 SAFETY PLATE
43	PRP64M ROLL PIN 3 X 18

REF PART #	DESCRIPTION
44	PH6332044 FIXED COVER
45	PSB15M CAP SCREW M5-.8 X 20
46	PH6332046 TORSION SPRING
47	PRP18M ROLL PIN 4 X 12
48	PH6332048 NOSE COVER LOCKING PIN
49	PH6332049 COMPRESSION SPRING
50	PH6332050 SLIDE BLOCK
51	PH6332051 HANDLE COVER
52	PH6332052 HANDLE
53	PSB110M CAP SCREW M4-.7 X 6
54	PH6332054 NOSE COVER
55	PRP61M ROLL PIN 3 X 12
56	PH6332056 MOVABLE NOSE COVER
57	PH6332057 DRIVER GUIDE
58	PSB16M CAP SCREW M4-.7 X 16
59	PH6332059 SAFETY GUARD CLAMP B
60	PSB145M CAP SCREW M3-.5 X 16
61	PH6332061 INLAY STRIP
62	PH6332062 MOVABLE MAGAZINE
63	PSS23M SET SCREW M4-.7 X 10
64	PH6332064 MAGAZINE SLIDE PLATE
65	PH6332065 SPRING CAP
66	PH6332066 COMPRESSION SPRING
67	PSB56M CAP SCREW M3-.5 X 10
68	PH6332068 FIX SEAT
69	PH6332069 TORSION SPRING
70	PRP42M ROLL PIN 3 X 20
71	PH6332071 CATCH LEVER
72	PSB18M CAP SCREW M4-.7 X 8
73	PH6332073 MAG. CONNECTOR PLATE
74	PH6332074 MAGAZINE HOUSING
75	PH6332075 SAFETY GUARD CLAMP A
76	PSB23M CAP SCREW M4-.7 X 12
77	PH6332077 RUBBER HANDGRIP
78	PLN08M LOCK NUT M3-.5
79	PH6332079 O-RING 40 X 2.65
80	PH6332080 END CAP
81	PH6332081 AIR PLUG 1/4 NPT
82	PH6332082 PISTON REPAIR KIT
83	PH6332083 CARRYING CASE
84	PAW03M HEX WRENCH 3MM
85	PAW04M HEX WRENCH 4MM

WARRANTY AND RETURNS

Grizzly Industrial, Inc. warrants every product it sells for a period of **1 year** to the original purchaser from the date of purchase. This warranty does not apply to defects due directly or indirectly to misuse, abuse, negligence, accidents, repairs or alterations or lack of maintenance. This is Grizzly's sole written warranty and any and all warranties that may be implied by law, including any merchantability or fitness, for any particular purpose, are hereby limited to the duration of this written warranty. We do not warrant or represent that the merchandise complies with the provisions of any law or acts unless the manufacturer so warrants. In no event shall Grizzly's liability under this warranty exceed the purchase price paid for the product and any legal actions brought against Grizzly shall be tried in the State of Washington, County of Whatcom.

We shall in no event be liable for death, injuries to persons or property or for incidental, contingent, special, or consequential damages arising from the use of our products.

To take advantage of this warranty, contact us by mail or phone and give us all the details. We will then issue you a "Return Authorization Number," which must be clearly posted on the outside as well as the inside of the carton. We will not accept any item back without this number. Proof of purchase must accompany the merchandise.

The manufacturers reserve the right to change specifications at any time because they constantly strive to achieve better quality equipment. We make every effort to ensure that our products meet high quality and durability standards and we hope you never need to use this warranty.

Please feel free to write or call us if you have any questions about the machine or the manual.

Grizzly Industrial, Inc.
1203 Lycoming Mall Circle
Muncy, PA 17756
Phone: (570) 546-9663
Fax: (800) 438-5901

E-Mail:
techsupport@grizzly.com

Web Site: <http://www.grizzly.com>

Thank you again for your business and continued support. We hope to serve you again soon!



WARRANTY CARD

Name _____

Street _____

City _____ State _____ Zip _____

Phone # _____ Email _____ Invoice # _____

Model # _____ Order # _____ Serial # _____

*The following information is given on a voluntary basis. It will be used for marketing purposes to help us develop better products and services. **All information is strictly confidential.***

1. How did you learn about us?

Advertisement Friend Catalog
 Card Deck Website Other: _____

2. Which of the following magazines do you subscribe to?

Cabinet Maker Popular Mechanics Today's Homeowner
 Family Handyman Popular Science Wood
 Hand Loader Popular Woodworking Wooden Boat
 Handy Practical Homeowner Woodshop News
 Home Shop Machinist Precision Shooter Woodsmith
 Journal of Light Cont. Projects in Metal Woodwork
 Live Steam RC Modeler Woodworker West
 Model Airplane News Rifle Woodworker's Journal
 Modeltec Shop Notes Other:
 Old House Journal Shotgun News

3. What is your annual household income?

\$20,000-\$29,000 \$30,000-\$39,000 \$40,000-\$49,000
 \$50,000-\$59,000 \$60,000-\$69,000 \$70,000+

4. What is your age group?

20-29 30-39 40-49
 50-59 60-69 70+

5. How long have you been a woodworker/metalworker?

0-2 Years 2-8 Years 8-20 Years 20+ Years

6. How many of your machines or tools are Grizzly?

0-2 3-5 6-9 10+

7. Do you think your machine represents a good value? Yes No

8. Would you recommend Grizzly Industrial to a friend? Yes No

9. Would you allow us to use your name as a reference for our customers in your area?

Note: *We never use names more than 3 times.* Yes No

10. Comments: _____

Send a Grizzly Catalog to a friend:

Name _____
Street _____
City _____ State _____ Zip _____

FOLD ALONG DOTTED LINE

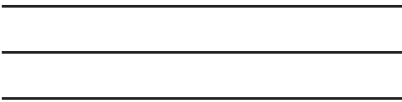

Place
Stamp
Here



GRIZZLY INDUSTRIAL, INC.
P.O. BOX 2069
BELLINGHAM, WA 98227-2069



TAPE ALONG EDGES--PLEASE DO NOT STAPLE

Free Manuals Download Website

<http://myh66.com>

<http://usermanuals.us>

<http://www.somanuals.com>

<http://www.4manuals.cc>

<http://www.manual-lib.com>

<http://www.404manual.com>

<http://www.luxmanual.com>

<http://aubethermostatmanual.com>

Golf course search by state

<http://golfingnear.com>

Email search by domain

<http://emailbydomain.com>

Auto manuals search

<http://auto.somanuals.com>

TV manuals search

<http://tv.somanuals.com>